



上海坤友电气有限公司
SHANGHAI KUNYOU ELECTRIC CO.,LTD

电能质量的综合治理

高度自动化

微处理器为核心的控制系统广泛应用，控制系统的可靠性决定了产品的质量、成本、安全，而自动控制系统稳定的保障是电能质量。

高度信息化：

企业管理高度依赖信息系统，信息系统稳定运行的条件是电能质量。

从电磁兼容的角度看电能质量

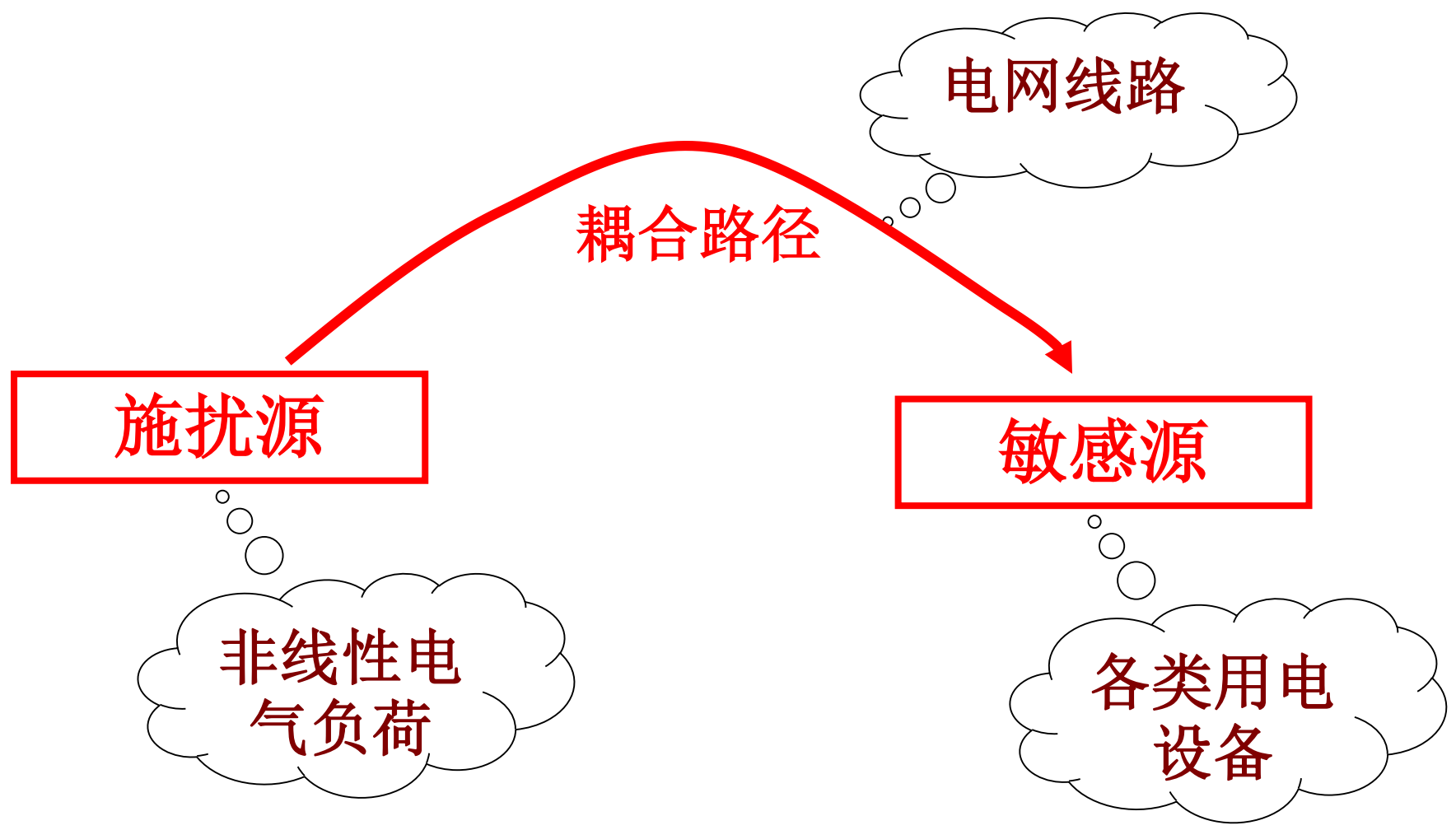

电网上常见的污染

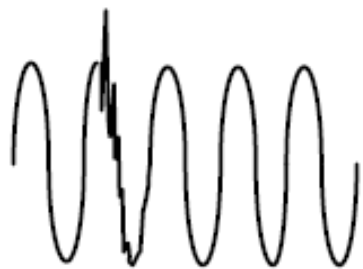

浪涌电压



电压骤降



谐波畸变

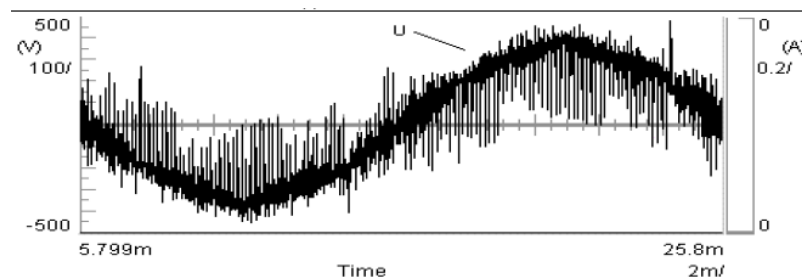

射频噪声

1、控制污染源：

最好的策略，从根源上解决问题

2、对电能进行净化

对于有些场合时必须的，例如雷电、浪涌、电压暂降

3、切断耦合通路

采用不同的电网供电，临时性措施

最严重的电能质量问题：谐波



现代的用电方式发生了巨大的改变，整流电路大量应用：

- 变频器、直流电机驱动器、中频炉
- 各种电源（**UPS**、充电器、直流电源等）
- 信息设备、**LED**显示屏、大型医疗设备
- 高效照明设备、功率受控的照明设备

整流电路产生严重的谐波电流！

电磁干扰形成的过程

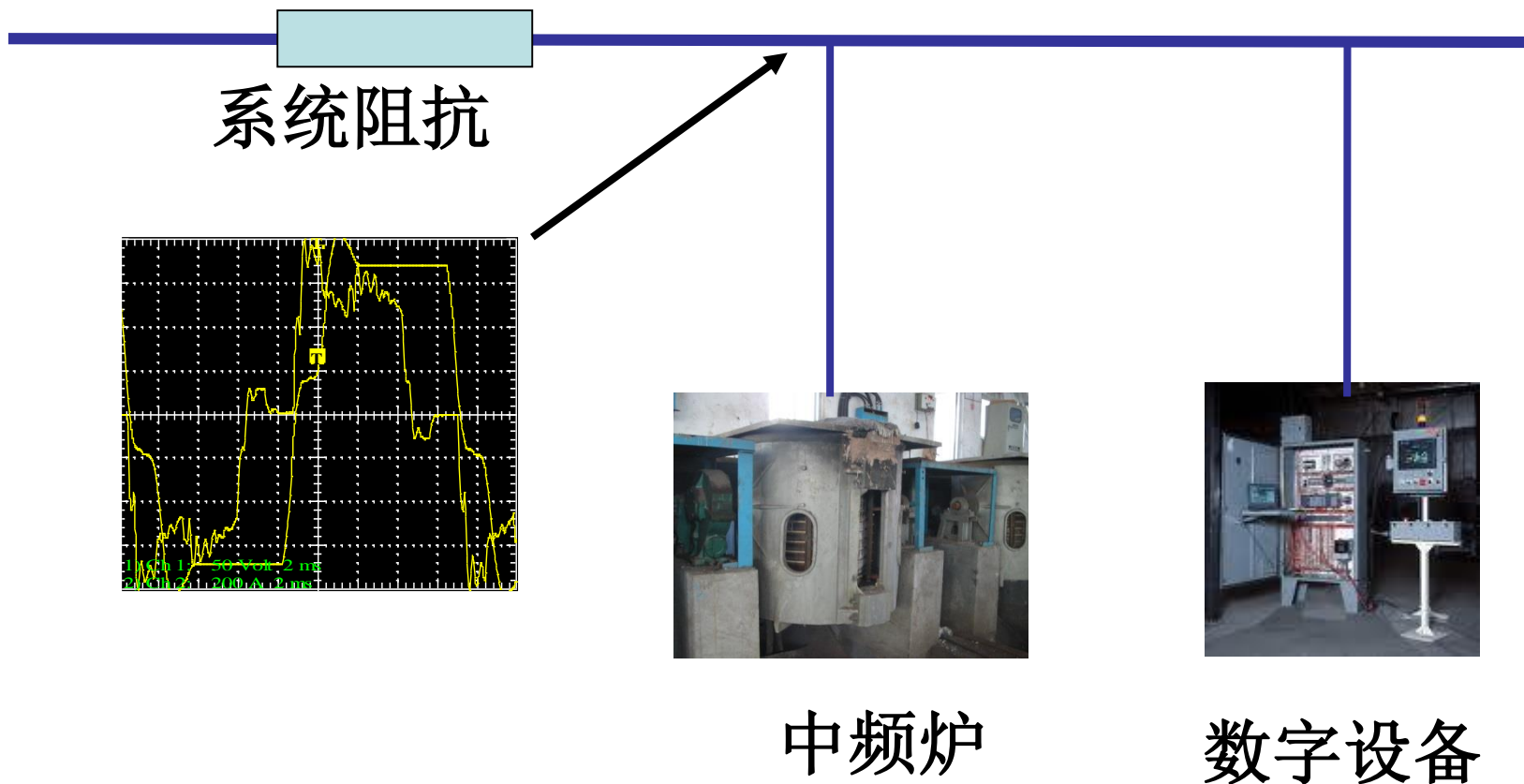

谐波电流

谐波电压

形成干扰

谐波电流是问题的本质

谐波电压

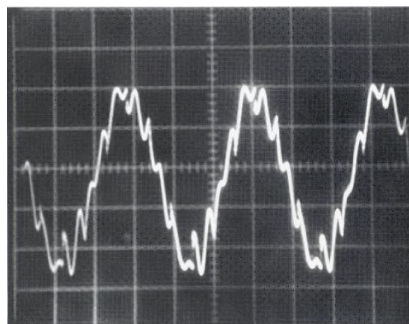

谐波电流

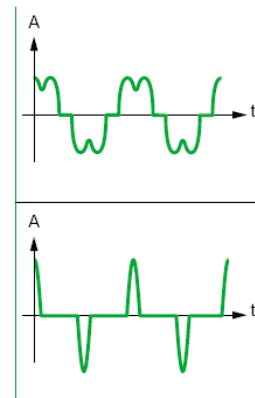

原始的电压波形没有畸变，负荷产生了谐波电流，才导致电压畸变

谐波电压的形成



谐波电流

谐波电压

= 谐波电流 × 系统阻抗



干扰源的影响与系统阻抗密切相关

电网容量越小（对应阻抗越高），越容易形成干扰

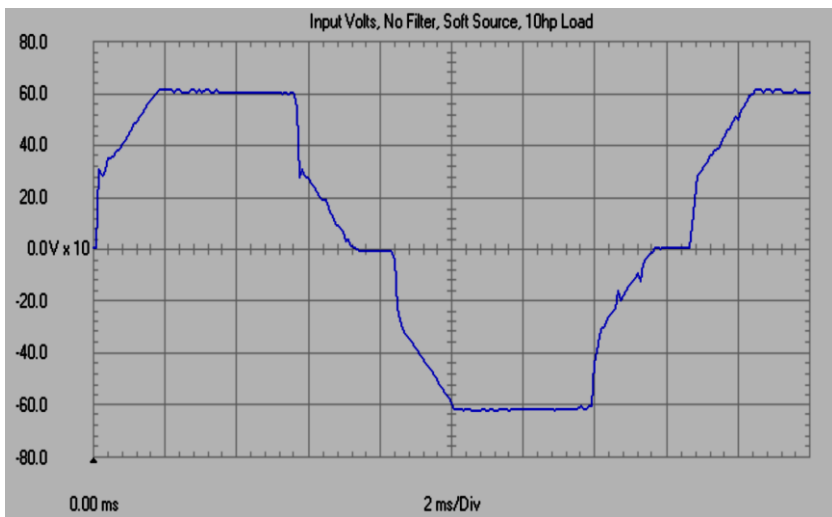

变压器容量较小的场合
产生较大的电压畸变

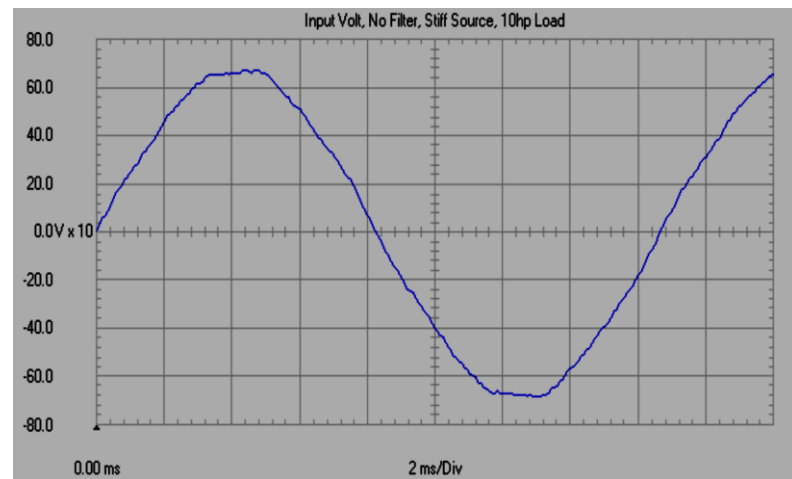

变压器容量较大的场合
产生较小的电压畸变

备用电源更怕谐波电流



卫星跟踪天线

UPS电源



备用电源的内阻更大，
UPS的谐波电流导致天线出现抖动现象。



发电机

解决电能质量问题的方法



电源
净化
装置

谐波
消除
装置



谐波治理的本质：减小谐波



谐波电流是电力谐波的根源。

发电厂发出的电力是标准的正弦波电压，不含谐波电压。发生畸变，都是由于用户造成的。

解决谐波问题，就是消除谐波电流！

KYYLB有源电力滤波器：8台装置并联

KYLB无源滤波装置：并联、串联

KYSVG低压静止无功发生器

KYSVG高压静止无功发生器

KYTBBL高压无功滤波补偿装置

谐波治理的效果

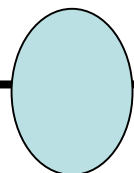
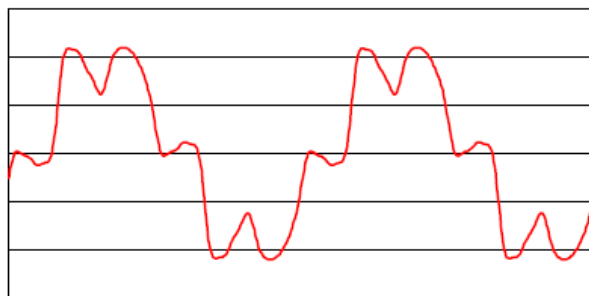
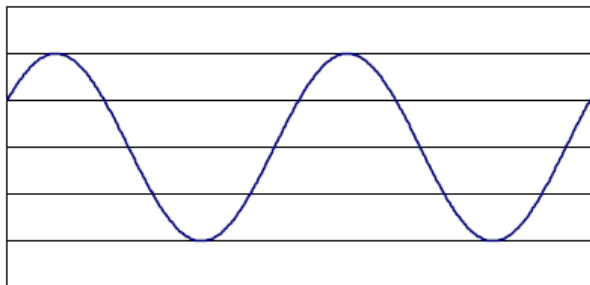

谐波治理点，任何方法仅
能保证上游的谐波电流畸
变率。



谐波治理的策略

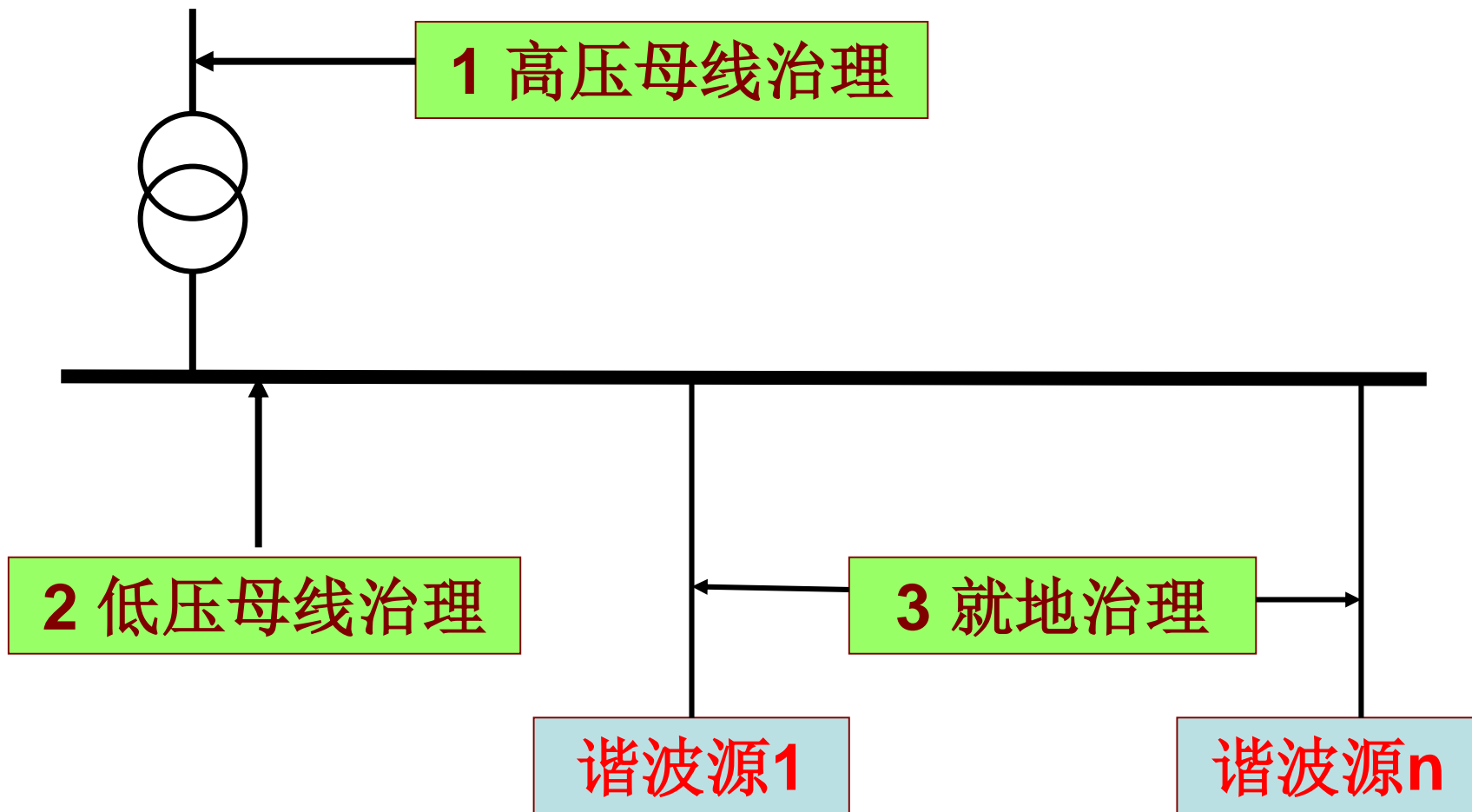

传统的谐波治理策略



内部电网质量没有保证

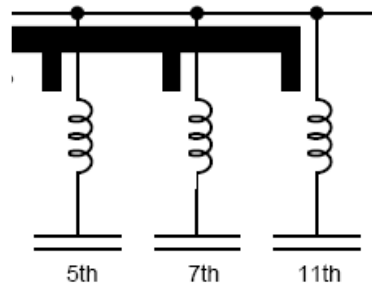

不同策略的比较

1 高压母线治理

2 低压母线治理

3 就地治理

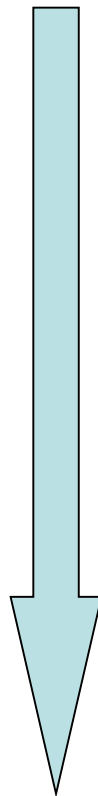

- 谐波的危害减小
- 治理的收益增加

不同策略得到的好处

	策略1	策略2	策略3
满足电网质量要求	√	√	√
减小变压器损耗		√	√
企业内部设备工作稳定			√
企业内部电能质量优良			√

谐波的综合治理

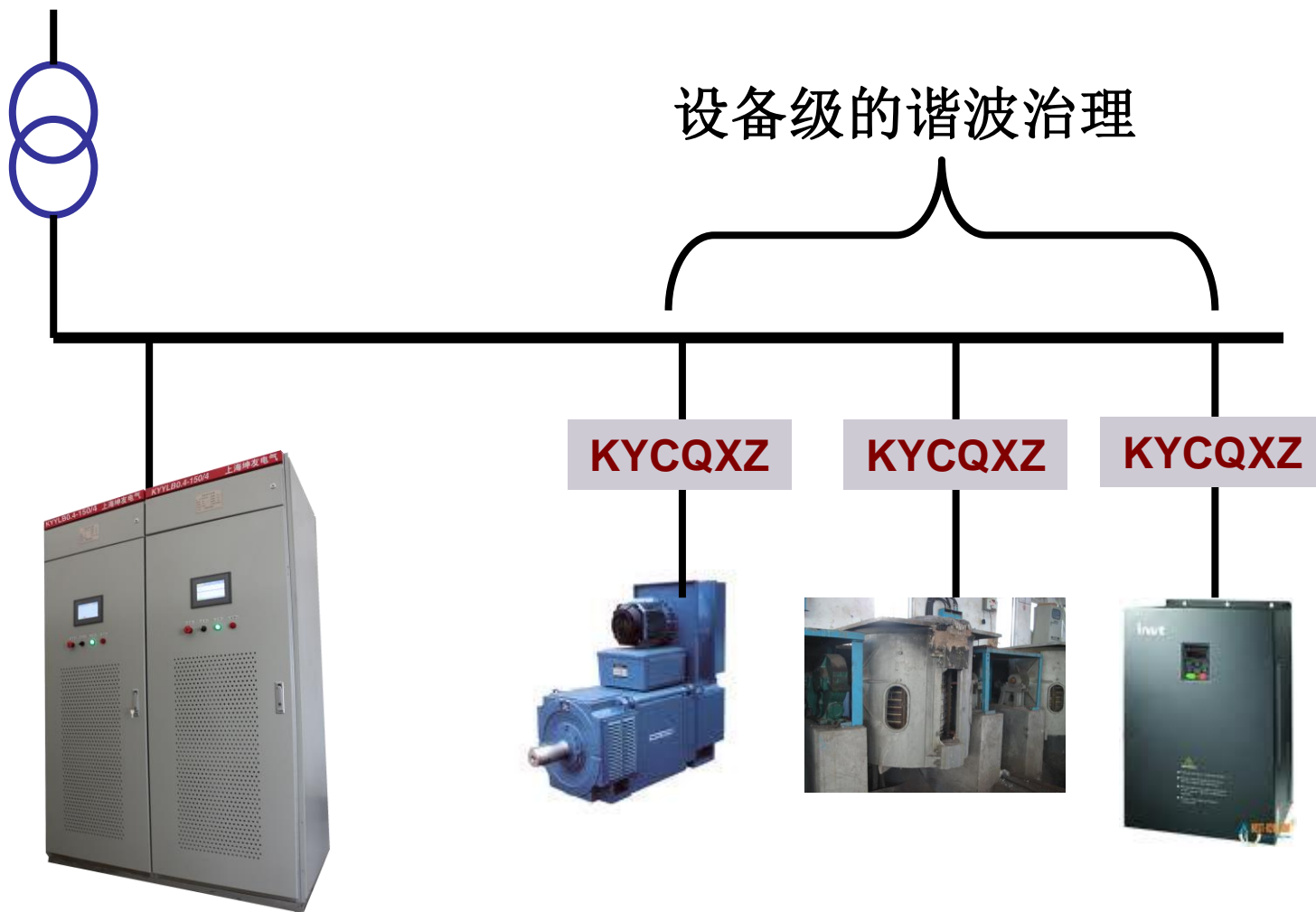

KYYLB有源电力滤波器

时代不同了，电能质量治理的观念也要改变：

过去：

主要为了保持公共电网的质量（满足电力公司的要求），履行用电用户的义务。

现在：

企业内部的电网质量同样不容忽视，企业应该更加关注内部的电能质量，保证生产制造系统的正常运行。

常用的谐波治理设备



名称	用途
KYTBBL 高压无功滤波补偿装置	安装在高压母线上，满足电力公司对功率因数、谐波电流的要求
KYYLB 有源电力滤波器	安装在低压母线上，或谐波源设备的电源输入端，使上游的谐波电流畸变率小于5%
KYLB 无源滤波装置	安装在谐波源设备的电源输入端，使上游的谐波电流畸变率小于8%

KYYLB有源电力滤波器



柜式有源电力滤波器



壁挂式有源电力滤波器

有源滤波器的原理

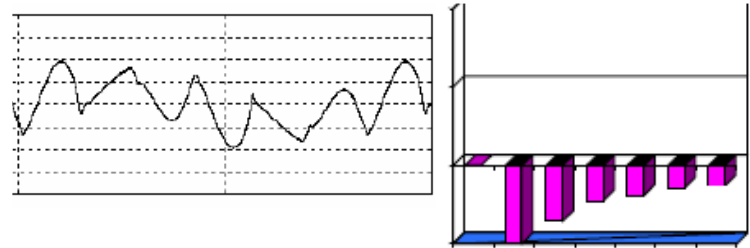
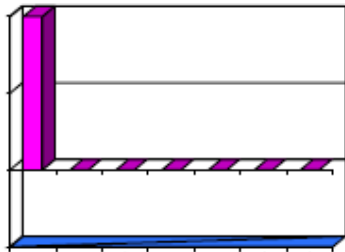
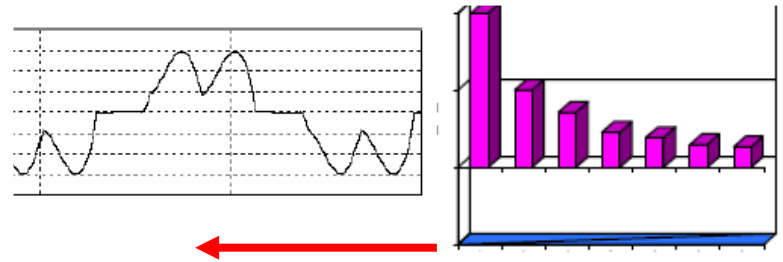
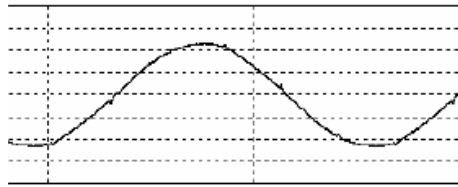

有源滤波器前后的电流

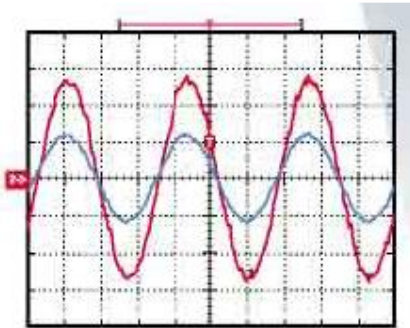

有有源滤波器

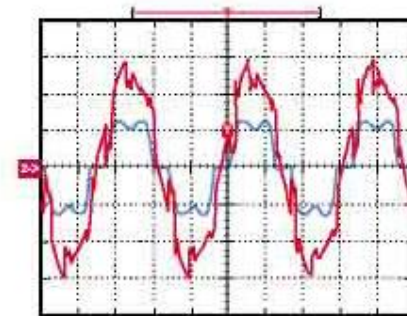
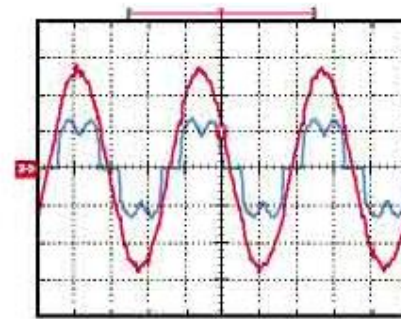

没有滤波的情况

注意事项：意外的射频干扰

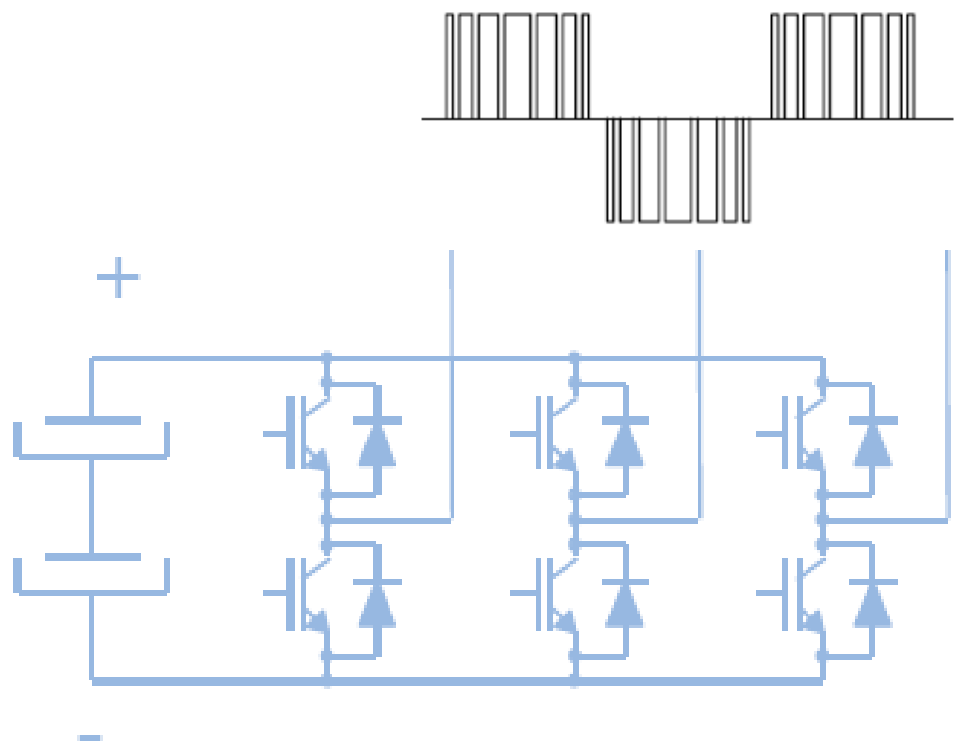

有源滤波器用PWM
波形合成谐波
与变频器的原理相同
因此，是射频干扰源。

对有源电力滤波器，除了要关注其滤波器性能以外，还要关注其电磁兼容性：

1. 不会向电网注入射频干扰，不会对电网上的其他设备形成干扰；
2. 不会向空间辐射电磁干扰，不会对邻近的设备形成干扰；
3. 有完善的雷电防护措施，全天候可靠运行。

有源滤波器的安装

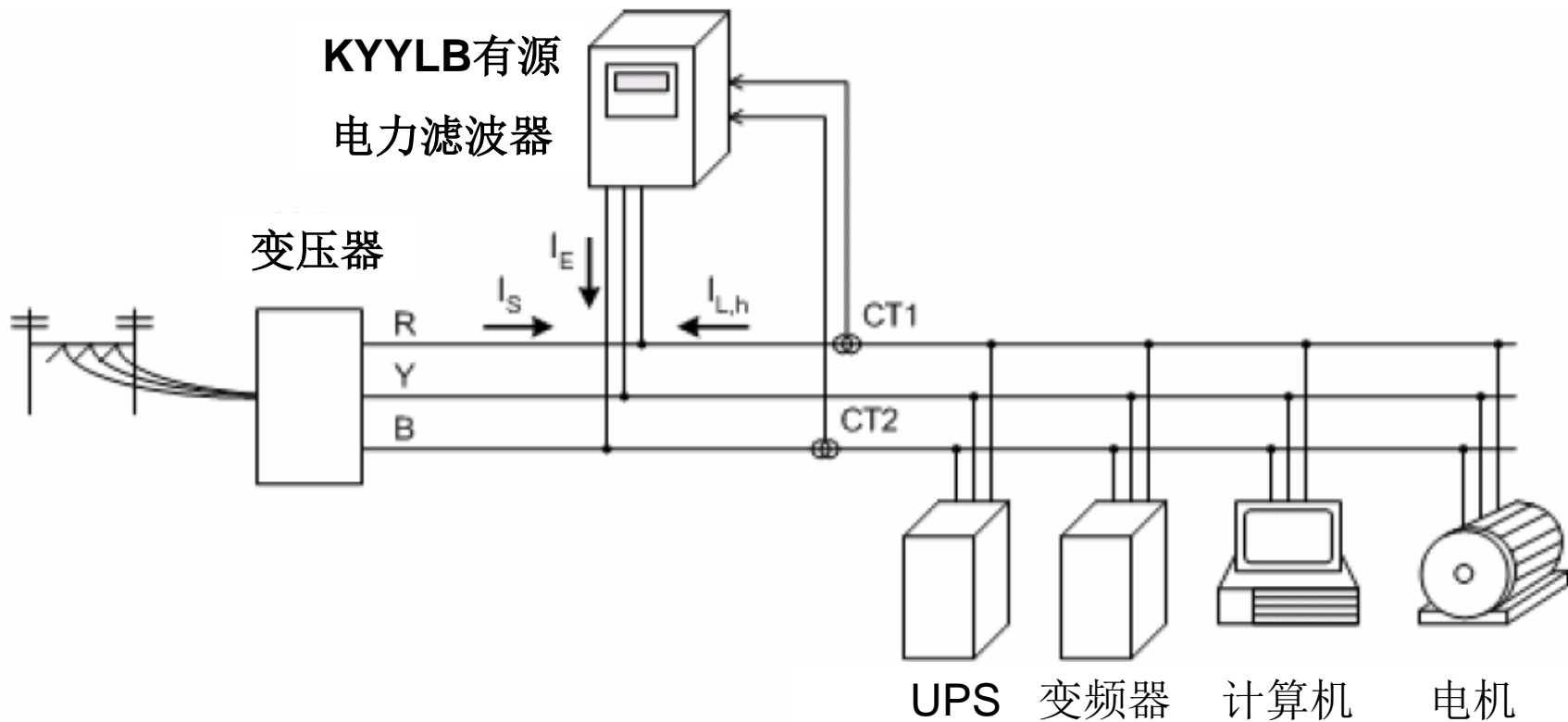

设备级谐波滤波器

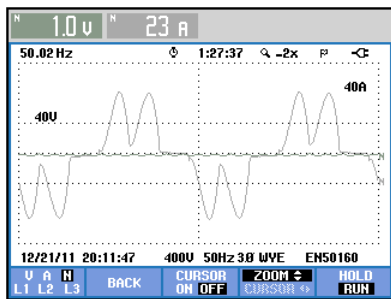

安装在设备的电源线入线端，减小谐波源设备的谐波电流发射。

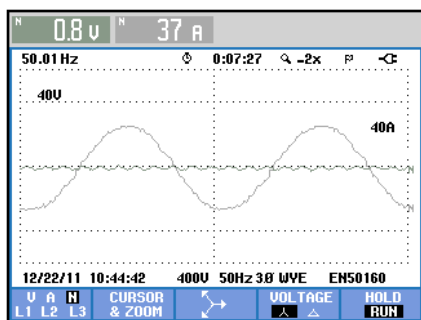

设备级谐波滤波器的特殊要求



1. 滤波效果确定，在任何系统中**THID**一定
2. 不吸收上游谐波电流
3. 不与系统发生不良影响
4. 不产生过大的容性无功
5. 可靠性高

设备级谐波滤波器的使用方法



串联安装



按照变频器的功率直接选型
即连即用，不需要现场调试

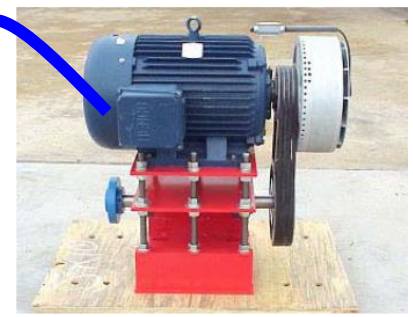

设备级谐波滤波器的效果

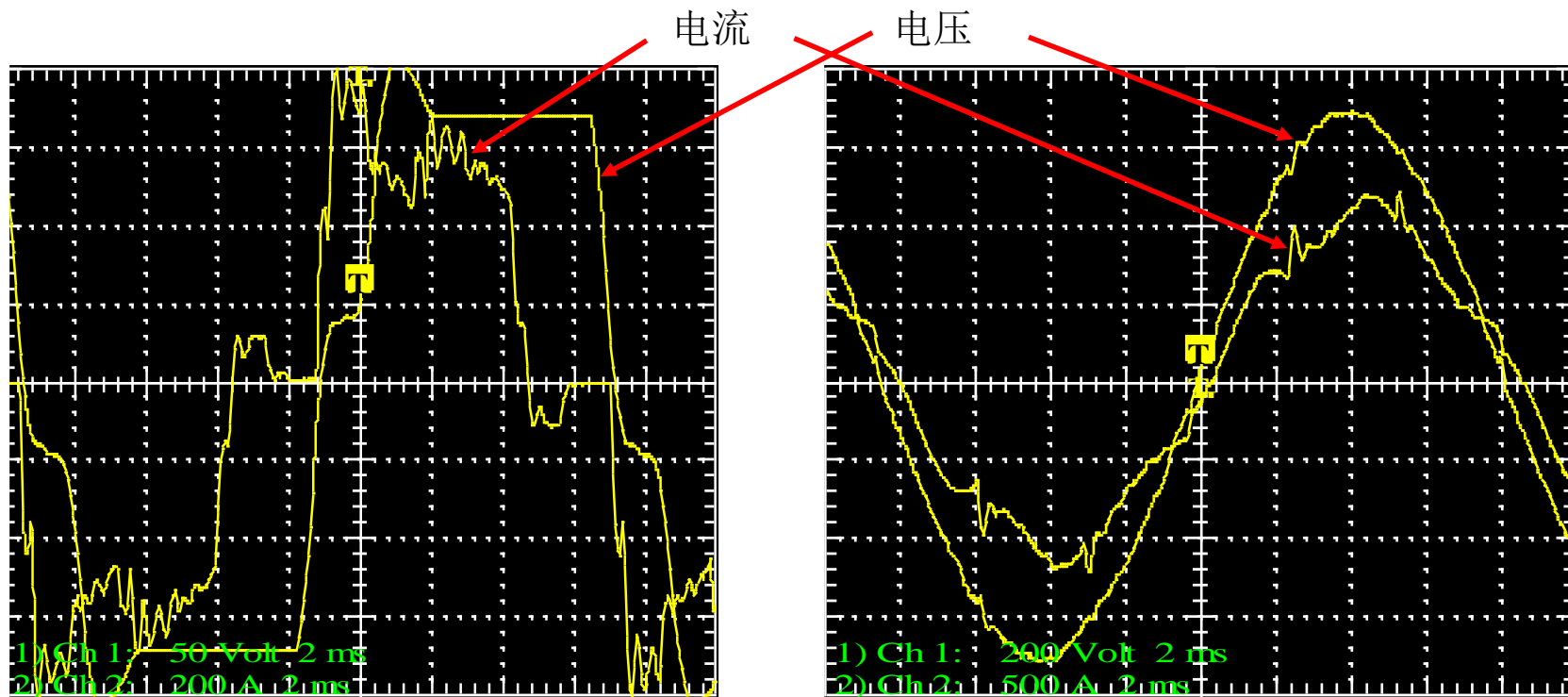

没有谐波滤波器时的波形

安装谐波滤波器后的波形

变频器带来的特殊问题



谐波电流

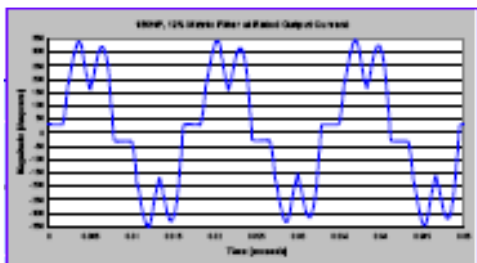

损害电网、
干扰其他电子设备



输出电压 (PWM)

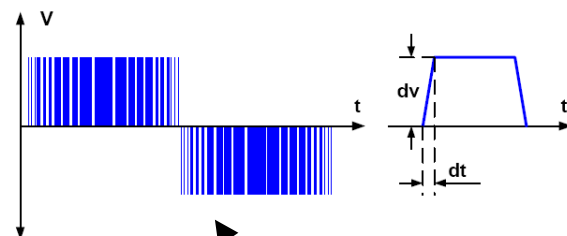

损害电机
电磁干扰

对电机的损伤



对电机线圈绕组的损伤

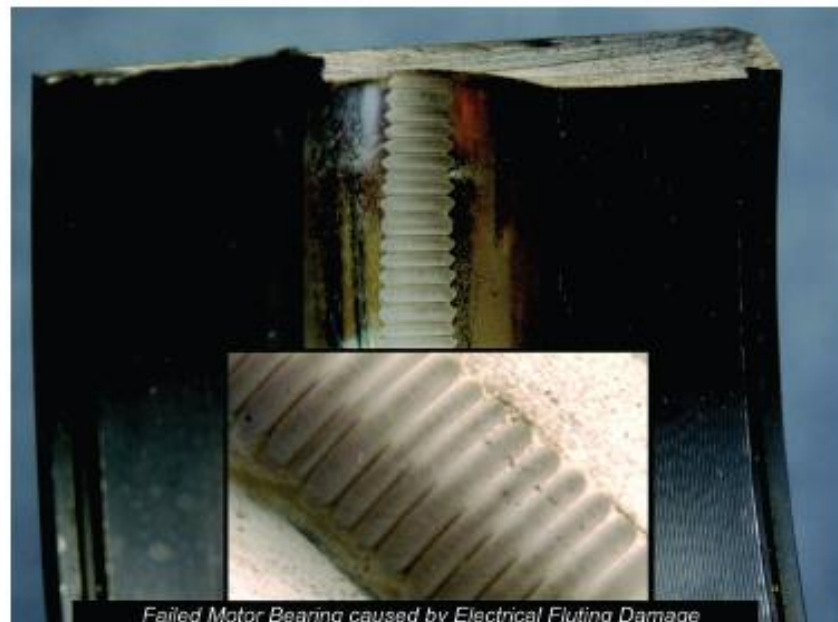

对电机轴承的损伤

PWM电压产生尖峰电压

入射波与反射波叠加，
产生尖峰电压。

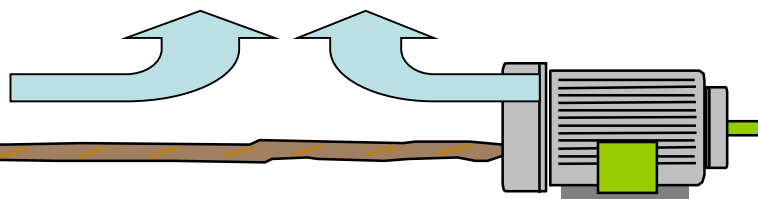
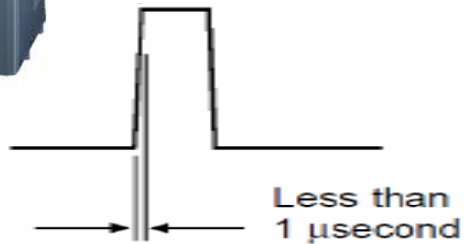
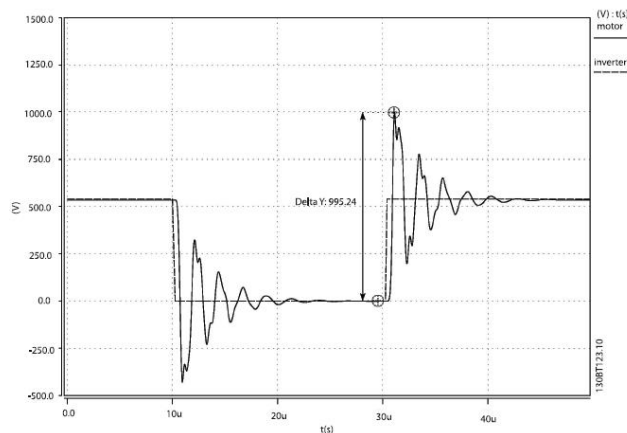

尖峰电压幅度与电缆长度



电缆长度超过30米时，电机端的尖峰电压达到 $2.7U_{AC}$

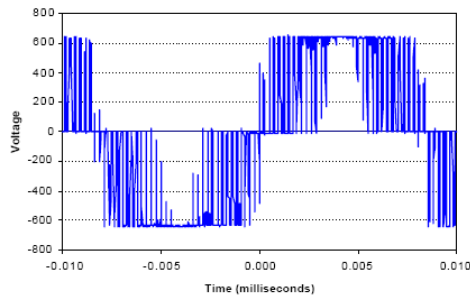
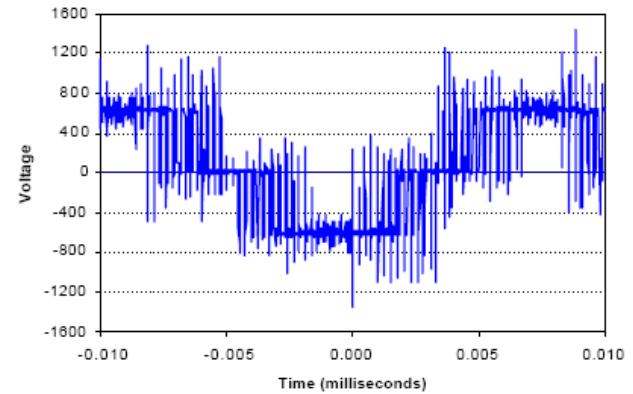

电机保护的方法：吸收尖峰电压



将尖峰电压吸收掉，并将其转换为热能耗散掉，是保护电机的新方法。这种方法采用并联安装，体积小、重量轻、性价比高（特别是大功率的场合）

变频器尖峰电压吸收器的效果



将尖峰电压变换成热能，
耗散到空间

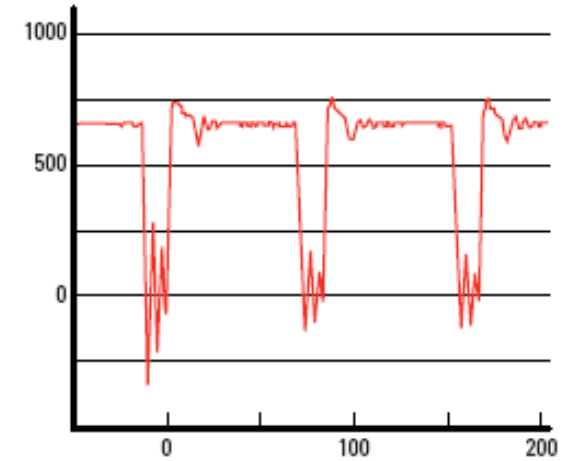
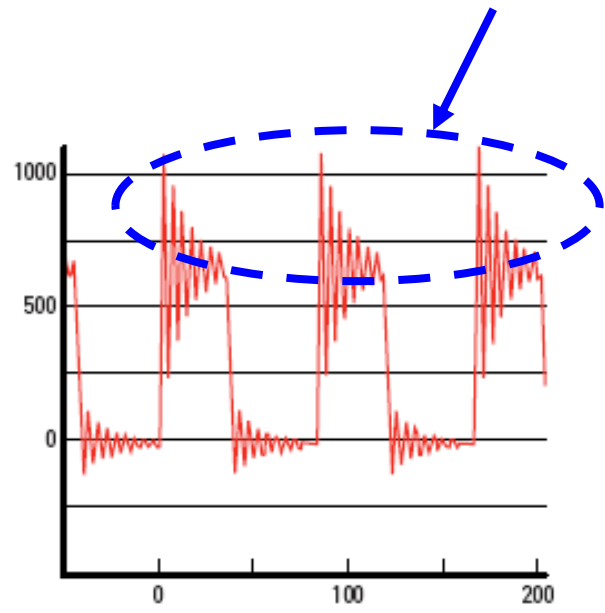

尖峰电压吸收器的使用方法



在电机端安装尖峰电压吸收器，减小尖峰电压的幅度



1. 要重视谐波电流导致的潜在风险
2. 要考虑谐波电流的控制
3. 要在谐波源处控制谐波电流
4. 采取灵活的谐波治理措施