

Operation Manual

Leakage Current Tester

TOS3200

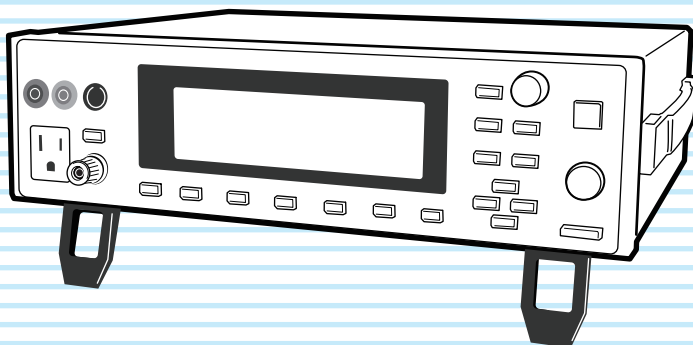

General
Description

1

Installation and
Preparation

2

Panel Control
Basics

3

TC and PCC Tests

4

Meter Mode
Measurement

5

Program Test

6

External Control

7

Remote Control

8

Maintenance

9

Specifications

10

App

Thank you for purchasing the TOS3200 Leakage Current Tester.

Use of Operation Manual

This manual is intended for first-time users of the TOS3200. It gives an overview of the TOS3200 and describes various settings, operation, SCPI commands, maintenance, safety precautions, etc.

Read this manual thoroughly to use the functions of the TOS3200 effectively. You can also review this manual when you are confused about an operation or when a problem occurs.

After reading, always keep the manual nearby so that you may refer to it as needed. When moving the product to another location, be sure to bring the manual as well.

If you find any incorrectly arranged or missing pages in this manual, they will be replaced. If the manual gets lost or soiled, a new copy can be provided for a fee. In either case, please contact Kikusui distributor/agent, and provide the "Kikusui Part No." given on the cover page.

This manual has been prepared with the utmost care; however, if you have any questions, or note any errors or omissions, please contact Kikusui distributor/agent.

Applicable firmware version of the TOS3200

This manual applies to TOS3200s with firmware version 2.0x.

When making an inquiry about the product, please provide us with the following information.

- Model (indicated at the top section on the front panel)
- Firmware version (See page 29.)
- Serial number (indicated at the bottom section on the rear panel)

How to read this manual

This manual is designed to be read from beginning to end. We recommend that you read this manual thoroughly from the beginning before using the TOS3200 for the first time.

Intended readers of this manual

This manual is intended for users of the TOS3200 or persons teaching other users on how to operate the TOS3200.

The manual assumes that the reader has knowledge about electrical safety testing.

Information on SCPI commands is provided with the premise that the reader has sufficient knowledge about controlling measuring instruments using a personal computer.

Waste Electrical and Electronic Equipment (WEEE)

Disposing of used Kikusui products in the EU

Under a law adopted by member nations of the European Union (EU), used electric and electronic products carrying the symbol below must be disposed of separately from general household waste.



This includes the power cords and other accessories bundled with the products.

When disposing of a product subject to these regulations, please follow the guidance of your local authority, or inquire with your Kikusui distributor/agent where you purchased the product.

The symbol applies only to EU member nations.

Disposal outside the EU

When disposing of an electric or electronic product in a country that is not an EU member, please contact your local authority and ask for the correct method of disposal.

Trademarks

Microsoft and Windows are registered trademarks of Microsoft Corporation in the United States and/or other countries.

Other company names and product names used in this manual are generally trademarks or registered trademarks of the respective companies.

Copyright

Reproduction and reprinting of this operation manual, whole or partially, without our permission is prohibited.

Both unit specifications and manual contents are subject to change without notice.

© 2007-2009 Kikusui Electronics Corporation



Safety Symbols

For the safe use and safe maintenance of this product, the following symbols are used throughout this manual and on the product. Note the meaning of each of the symbols to ensure safe use of the product. (Not all symbols may be used.)

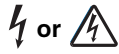

Indicates that a high voltage (over 1000 V) is used here. Touching the part causes a possibly fatal electric shock. If physical contact is required by your work, start work only after you make sure that no voltage is output here.

DANGER

Indicates an imminently hazardous situation which, if ignored, will result in death or serious injury.



WARNING

Indicates a potentially hazardous situation which, if ignored, could result in death or serious injury.



CAUTION

Indicates a potentially hazardous situation which, if ignored, may result in damage to the product and other property.



Shows that the act indicated is prohibited.



Indicates a general danger, warning, or caution. When this symbol is marked on the product, see the relevant sections in this manual.



Protective conductor terminal.



Chassis (frame) terminal.



On (supply)



Off (supply)



In position of a bi-stable push control



Out position of a bi-stable push control

Notations Used in This Manual

- The TOS3200 Leakage Current Tester is also simply referred to as the TOS3200 in this manual.
- Equipment under test is also referred to as the EUT in this manual.
- The word "PC" used in this manual is a generic term for personal computers and workstations.
- Touch current is simply referred to as TC in this manual.
- Protective conductor current is simply referred to as PCC in this manual.
- The following markings are used in this manual.



WARNING

Indicates a potentially hazardous situation which, if ignored, could result in death or serious injury.



CAUTION

Indicates a potentially hazardous situation which, if ignored, may result in damage to the product and other property.

NOTE

Indicates information that you should know.

DESCRIPTION

Explanation of terminology or operation principle.



Indicates reference to detailed information.



Indicates the menu level of the item to be selected. The menu item to the left of the > symbol is a higher level menu.

SHIFT+key name (marked in blue)

Indicates an operation involving pressing the named key (shown in blue) while the SHIFT key is held down.

SHIFT+Fx (F1 to F5)

Indicates an operation involving pressing a function key (F1 to F5) while the SHIFT key is held down.

Safety Precautions

The following safety precautions must be observed to avoid fire hazards, electric shock, accidents, and other failures. Keep them in mind and make sure to observe them.

Using the product in a manner that is not specified in this manual may impair the protection functions provided by the product.



Users

- This product must be used only by qualified personnel who understand the contents of this operation manual.
- If an unqualified personnel is to use the product, be sure the product is handled under the supervision of qualified personnel (those who have electrical knowledge). This is to prevent the possibility of personal injury.



Purpose of use

- Never use the product for purposes other than the product's intended use.
- This product is not designed or manufactured for general home or consumer use.

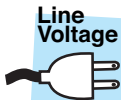

Input power

- Use the product within the rated input power voltage range.
- For applying power, use the power cable provided. For details, see the respective page in the operation manual.
- This product is an equipment of IEC Overvoltage Category II (energy-consuming equipment supplied from the fixed installation).



Fuse

- The fuse can be replaced on this product. When replacing the fuse, use a fuse of shape, rating, and characteristics that conform to the product. For details, see the respective page in the operation manual.



Cover

- Some parts inside the product may cause physical hazards. Do not remove the external cover.



Grounding

- This product is an IEC Safety Class I equipment (equipment with a protective conductor terminal). To prevent electric

shock, be sure to connect the protective conductor terminal of the product to electrical ground (safety ground).

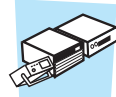

Installation

- This product is designed for safe indoor use. Be sure to use the product indoors.
- When installing products, be sure to observe precautions concerning installation location. For details, see the respective page in the operation manual.



Relocation

- Turn off the POWER switch, and disconnect the cables before relocating the product.
- When relocating the product, be sure to include the manual.



Operation

- If a malfunction or abnormality is detected on the product, stop using it immediately, and remove the power cord plug from the outlet. Make sure the product is not used until it is completely repaired.
- Do not disassemble or modify the product. If you need to modify the product, contact your Kikusui distributor/agent.



Maintenance and inspection

- To prevent electric shock, be sure to unplug the product before carrying out maintenance or inspection. Do not remove the external cover.
- Check periodically that there are no tears or breaks in the power cord and the test lead covering.
- If the panel needs cleaning, gently wipe using a soft cloth with water-diluted neutral detergent. Do not use volatile chemicals such as benzene or thinner.
- To maintain the performance and safe operation of the product, it is recommended that periodic maintenance, inspection, cleaning, and calibration be performed.



Service

- Kikusui service engineers will perform internal service on the product. If the product needs adjustment or repairs, contact your Kikusui distributor/agent.

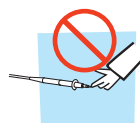

Test leads

- To avoid electric shock, do not touch the tip of a test lead while testing (during the touch current measurement).

DANGER lamp

- The DANGER lamp illuminates while the test is in progress. If the DANGER lamp is illuminated, the voltage applied to AC LINE IN (EUT) is output to the AC LINE OUT terminal.

Measurement category

- Measurement terminals A and B comply with IEC Standard Measurement Category II. Measurement Category II (CAT II) is used to measure the primary circuit of equipment (household electric appliances, portable tools, etc.) that is connected directly to a low-voltage installation such as an outlet.

Ground terminal

- In case of measuring the touch current in the condition of "Earth line disconnected status" of the EUT, a hazardous voltage may apply to the ground terminal. Do not touch the ground terminal while the test is in progress.

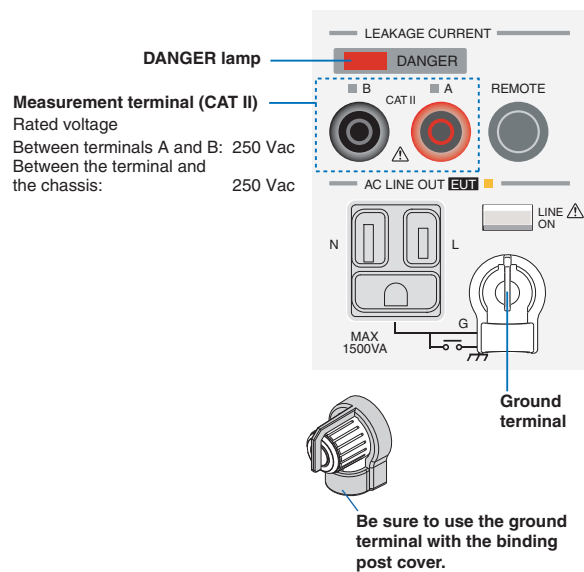

Contents

Use of Operation Manual	2
Safety Symbols	3
Notations Used in This Manual	3
Safety Precautions	4
Contents	6
Contents by Objectives	12
Front panel	14
Rear panel.....	16

1 General Description

Product Overview.....	18
Features.....	18
Options.....	20
Rack Mounting Option	20
Test Probe	20
Multi Outlet.....	21

2 Installation and Preparation

Checking the Package Contents.....	24
Precautions Concerning Installation Location	25
Using the Stand	26
Precautions for Moving the Product.....	26
Connecting the Power Cord.....	27
Connecting the Power Cord for the TOS3200	28
Connecting the Power Cord for the EUT.....	28
Turning the Power On.....	29
Turning the POWER Switch On.....	29
Turning the POWER Switch Off.....	30

3 Panel Control Basics

Screen Configuration	32
Panel Control	34
Switching the Screen	34
Selecting Items	34
Entering Data	35
Adjusting the Screen Brightness.....	36
Key Lock	36
Selecting the Operation Mode.....	37
Single Tests (TC/PCC/METER).....	37
Program Tests (AUTO).....	37
Panel Memory.....	38
Storing to the Test Conditions.....	39
Recalling from the Test Conditions.....	39

4

TC and PCC Tests

Connecting the EUT	42
Using the Output on the Front Panel	42
Using the Terminal Block on the Rear Panel	42
Using the Optional Multi Outlet (OT01-TOS).....	43
Checking the EUT Operation	44
Connecting the Test lead (TL21-TOS)	45
Using the Flat Probe (FP01-TOS)	48
Using the Optional Test Probe (HP21-TOS)	49
Measurement Check	49
Judgment System.....	50
Validity of the Lower Reference	50
Test Wait Time and Judgment	51
Setting Test Conditions of the TC Measurement	52
Setup Items of TC1/2 (PROBE / POL / COND)	52
Setup Items of TC1/2 (LOWER / UPPER / TIMER / WAIT)	54
Setup Items of TC2/2 (NTWK / MODE / RANGE).....	55
Setting Test Conditions of the PCC Measurement.....	56
Setup Items of PCC1/2 (POL / COND)	56
Setup Items of PCC1/2 (LOWER / UPPER / TIMER / WAIT)	58
Setup Items of PCC2/2 (MODE / RANGE).....	59
Setting Additional Test Conditions	60
Maximum Value Hold Function of the Measured Current (MEAS MODE)	60
Hold Time of the PASS Judgment (PASS HOLD).....	60
Measured Current Conversion Display (CONV).....	61
Buzzer Volume (BUZ VOL)	61
Starting the Test	62
Starting the Test.....	62
When the Test Starts.....	62
Switching to Expanded Display	64
Displaying the Voltage between the Measurement Network Reference Points ..	64
Unable to Start the Test	65
Stopping the Test	66
Aborting the Test.....	66
When the Test Ends.....	66
Storing the Test Result.....	66
Releasing the Judgment Result	66
Storing the Test Results	67
Displaying the Test Results	68
Deleting the Stored Data	68

5

Meter Mode Measurement

Connecting the EUT	70
Constructing the Connection Circuit.....	70
Connecting the Test lead (TL21-TOS)	71
Measuring in Meter Mode.....	72
Maximum Value Hold Function of the Measured Current (MEAS MODE)	72
SELV Detection Function	73
Setup Items of METER2/2 (NTWK / MODE / RANGE).....	73

6 Program Test

Program Tests.....	76
Limitations on the Test Conditions in the Steps.....	77
Interval Time.....	77
Creating Sequence Programs.....	78
Inserting a Step in a New Program.....	78
Inserting a Step in an Existing Program.....	79
Deleting a Step.....	79
Setup Items of AUTO1/2.....	80
Setup Items of AUTO2/2 (Common to All Steps).....	82
Sequence Program Editing Procedure.....	83
Entering the Edit Screen.....	83
Setting Items Common to the Program (All Steps).....	84
Setting Step 00.....	84
Setting Step 01.....	85
Exiting from the Edit Screen.....	85
Setting Additional Test Conditions.....	86
Maximum Value Hold Function of the Measured Current (MEAS MODE).....	86
Hold Time of the PASS Judgment (PASS HOLD).....	86
Measured Current Conversion Display (CONV).....	87
Buzzer Volume (BUZ VOL).....	87
Power supply to the EUT during the interval time (LINE BRK (AUTO)).....	88
Starting the Test.....	88
Starting the test.....	88
When a test starts.....	88
Unable to Start the Test.....	90
Stopping the Test.....	91
Aborting the Test.....	91
When the Test Ends.....	91
Program Test Judgment.....	91
Storing the Test Result.....	92
Releasing the Judgment Result.....	92
Storing the Test Results.....	93
Displaying the Test Results.....	94
Deleting the Stored Data.....	94

7 External Control

SIGNAL I/O Connector.....	96
SIGNAL I/O Specifications.....	96
Internal Construction.....	98
Application Examples of Input Signal.....	98
Application Examples of Output Signal.....	99
Starting the Test.....	99
Recalling the Panel Memory and Sequence Program.....	100

8 Remote Control

Remote Control Overview.....	102
VISA Library.....	103
Using the RS232C Interface.....	104
Using the GPIB Interface.....	107
Using the USB Interface.....	109
Overview of Messages.....	110

SCPI Command Syntax	110
Parameters	112
Command Description in This Manual	114
IEEE488.2 Common Commands	115
Selecting the Operation Mode	118
Setting the TC Measurement and PCC Measurement	118
Setting the Connection Destination of the Measurement Terminal (TC measurement only)	118
Setting the Power Line Polarity	119
Setting the Single Fault Mode	119
Setting the Lower Reference	120
Setting the Upper Reference	120
Setting the Test Time and Test Wait Time	121
Setting the Measurement Network (TC measurement only)	123
Setting the Measurement Mode	123
Setting the Measurement Range	124
Querying the Settings	124
Saving and Recalling from the Panel Memory	125
Executing the Test (Trigger Function)	126
Saving and Querying the Test Result	130
Querying the Judgment Result (Common to All Tests)	130
Saving the Result	130
Querying the Result	131
Deleting the Test Results	132
Setting the Program Test	133
Setting the Meter Mode Measurement	138
Setting the Measurement Network (Current Measurement Only)	138
Setting the Measurement Mode	138
Setting the Measurement Range (Current Measurement Only)	139
Querying the Settings	139
Querying the Measured Value	140
Querying the Measured Current Flowing through Measurement Terminals A and B	140
Querying the Measured Voltage between the Measurement Network Reference Points	140
Querying the Measured Voltage between Measurement Terminals A and B (Voltage Measurement Only)	141
Clearing the Maximum Measured Value	142
Voltage, current, and power of the EUT	142
Various Settings	144
Holding the Maximum Measured Current	144
Pass Judgment Hold Time	144
Converting Measured Current Based on the Specified Line Voltage	144
Setting the Safety Extra Low Voltage (SELV)	145
Setting the Buzzer Volume	145
Setting the Screen Brightness	146
Setting the Time	146
Turning the Power Line to the EUT On/Off	147
Showing/Hiding Communication Errors	147
Releasing the Protection Status	147
Other Settings	148
Status Register and Status Report Function	150
IEEE488.2 Register Model	152
Status Byte Register	152
Event Status Register	153
SCPI Register Model	154
OPERation Status Register	154

QUEStionable Status Register.....	156
Preset Status	157
Tutorial	158
TC Measurement/PCC Measurement (MANUAL TEST)	158
Program Test (AUTO TEST).....	159
Meter Mode Measurement.....	160

9 Maintenance

Test Lead Check.....	162
Measurement Check.....	162
Time Settings and Calibration Management.....	164
Calibration.....	165
Replacing the Fuse	166
Replacing the Backup Battery.....	166

10 Specifications

Measurement Items, Measurement Mode, and Measurement Network.....	168
Current Measurement Section*1.....	168
Judgment Function	170
Voltage Measurement Between A and B	171
Timer, Test Function, and Memory	171
Other Functions	172
Interface	173
General	174
Outline Drawing	175
Measurement Network (NTWK).....	176

Appendix

A Glossary	178
B Four Principal Tests for Evaluating the Safety of Electrical and Electronic Products	180
Withstanding Voltage Test.....	181
Insulation Resistance Test.....	182
Earth Continuity Test	183
Leakage Current Test	184
C A List of Messages	186
D A List of Errors	192
E Processing Time of Main Commands.....	195
F A List of Default Settings	196
Initializing the TOS3200.....	196
Default Values of the Panel Memory.....	198
G System Settings	200
Setup Items of SYSTEM1/5.....	200
Setup Items of SYSTEM2/5.....	201
Setup Items of SYSTEM3/5.....	202
Setup Items of SYSTEM4/5.....	202
Setup Items of SYSTEM5/5.....	203
H Protection Function	204
I Troubleshooting	205

INDEX 207

Contents by Objectives

Preparation

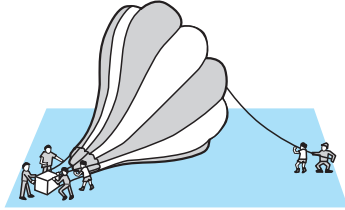

- **What accessories are included?**
→“Checking the Package Contents” 24

- **The EUT power cord cannot be connected to the front panel outlet. What is the workaround?**
→“Using the Terminal Block on the Rear Panel” 42

- **How do I check the operation of the EUT before testing?**
→“Checking the EUT Operation” 44

- **How do I measure the TC (when touching with my palm)?**
→“Using the Flat Probe (FP01-TOS)” 48

- **How do I use the two test leads?**
→“Connecting the Test lead (TL21-TOS)” 45

- **How do I check that correct measurements can be made during the preliminary inspection?**
→“Measurement Check” 162

Setting

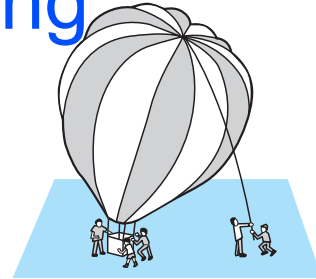

- **How do I measure the TC?**
→“Setting Test Conditions of the TC Measurement” 52

- **How do I measure the PCC?**
→“Setting Test Conditions of the PCC Measurement” 56

- **How do I measure the TC using the external circuit for that I was using until now?**
→“Meter Mode Measurement” 69

- **How are the measured values are judged?**
→“Judgment System” 50

- **How do I stop measurements while the EUT is starting up?**
→“Test Wait Time and Judgment” 51

- **What is the maximum value during the measurement?**
→“Maximum Value Hold Function of the Measured Current (MEAS MODE)” 60

- **What is the measured value at the voltage that is higher (or lower) than the actual power voltage supplied to the EUT.**
→“Measured Current Conversion Display (CONV)” 61

- **How do I find when the TOS3200 was calibrated the last time?**
→“Time Settings and Calibration Management” 164

Operation

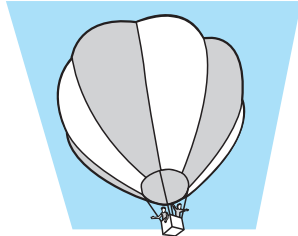

• How do I save the test results?	
→“Storing the Test Results”	67

• How do I save the present test conditions and use them later?	
→“Panel Memory”	38

• How do I measure the voltage between measurement terminals A and B?	
→“Displaying the Voltage between the Measurement Network Reference Points”	64
→“Measuring in Meter Mode”	72

• How do I prevent the test conditions from being changed inadvertently?	
→“Key Lock”	36

• How do I perform consecutive tests by changing the test conditions for each test?	
→“Program Tests”	76

• How do I apply an external signal to control the TOS3200?	
→“SIGNAL I/O Connector”	96

• How do I record the start and end of the test on the printer?	
→“Talk mode”	106

Maintenance

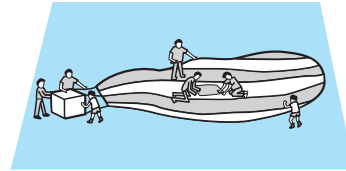

• How do I check whether the test leads are conducting signals correctly?	
→“Measurement Check”	162

• How do I change the calibration due date?	
→“Time Settings and Calibration Management”	164

• How do I synchronize the system clock?	
→“Time Settings and Calibration Management”	164

• How do I replace the fuse?	
→“Replacing the Fuse”	166

Troubleshooting

See “Troubleshooting” on page 205.

Front panel

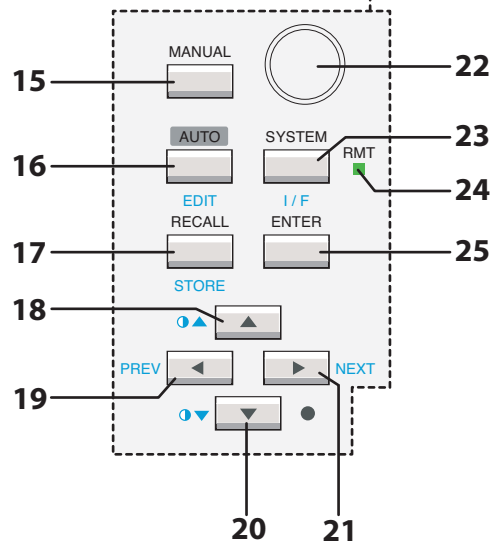
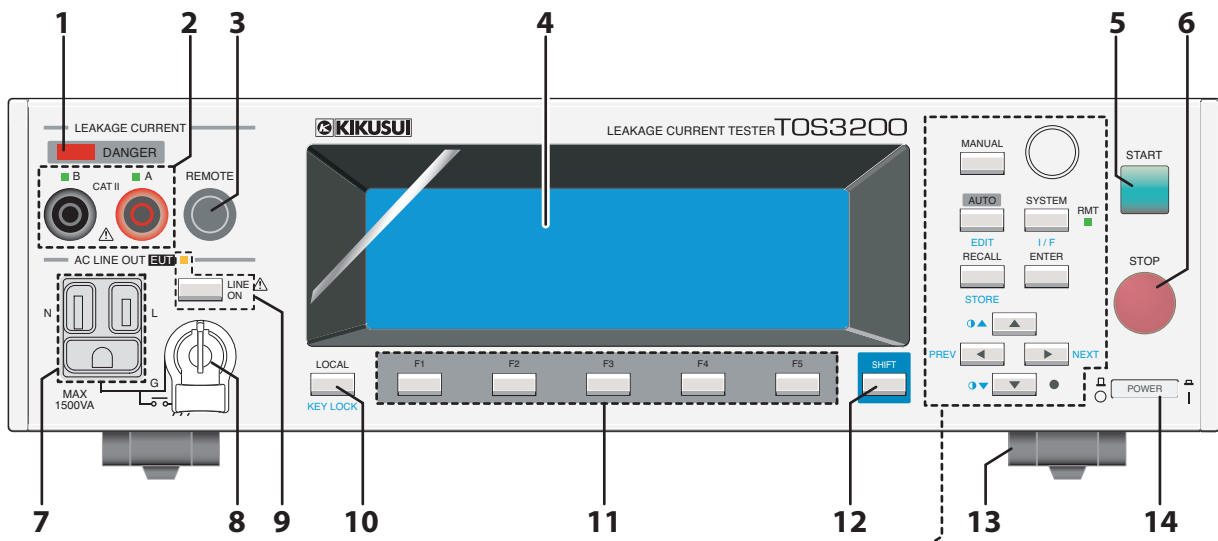

No.	Name	Function	See Page
1	DANGER lamp	Illuminates while a test is in progress.	5, 62
2	A/B terminal	Measurement terminal. Connect the test lead or probe to this terminal. If this terminal is required depending on the test mode, the LED above the terminal will illuminate.	5, 46
3	REMOTE connector	A dedicated connector used to connect the HP21-TOS option probe.	49
4	Display	Displays various types of information such as settings and measured values.	32
5	START switch	Starts the test.	62
6	STOP switch	Stops the test.	66
7	AC LINE OUT EUT	Supplies the power applied to the AC inlet for the EUT.	42
8	Ground terminal	Connect the ground wire when connecting a two-prong cord with a ground wire to AC LINE OUT.	5, 42
9	LINE ON key	Turns the output of AC LINE OUT. The LED above the key illuminates while the output is on.	44
10	LOCAL key	Switches between the remote and local modes.	102
	KEY LOCK key	Disables only the operations that change the settings.	36
11	F1 ~ F5 key	Function keys corresponding to the menu that appears on the screen.	33
12	SHIFT key	Calls up the functions marked in blue characters.	—
13	Leg and stand	Allows you to lift up the front panel side of the unit.	26
14	POWER switch	Turn the power on (I) or off (O).	29
15	MANUAL key	Selects the operation mode.	37
16	AUTO key	Selects the program test.	76
	EDIT key	Edits the test conditions of the program test.	
17	RECALL key	Recalls settings from the panel memory.	38
	STORE key	Stores the settings to the panel memory.	
18	▲ key	Moves the cursor up.	34
	●▲ key	Increases the screen brightness.	36
19	◀ key	Moves the cursor to the left.	34
	PREV key	Returns to the previous screen.	
20	▼ key	Moves the cursor down.	34
	●▼ key	Decreases the screen brightness.	36
21	▶ key	Moves the cursor to the right.	34
	NEXT key	Moves to the next screen.	
22	Rotary knob	Changes the settings.	35
23	SYSTEM key	Displays the system settings.	200
	I/F key	Displays the interface settings.	102
24	RMT LED	Illuminates when the TOS3200 is operating in remote control mode.	102
25	ENTER key	Confirms the panel memory to be recalled.	38

Rear panel

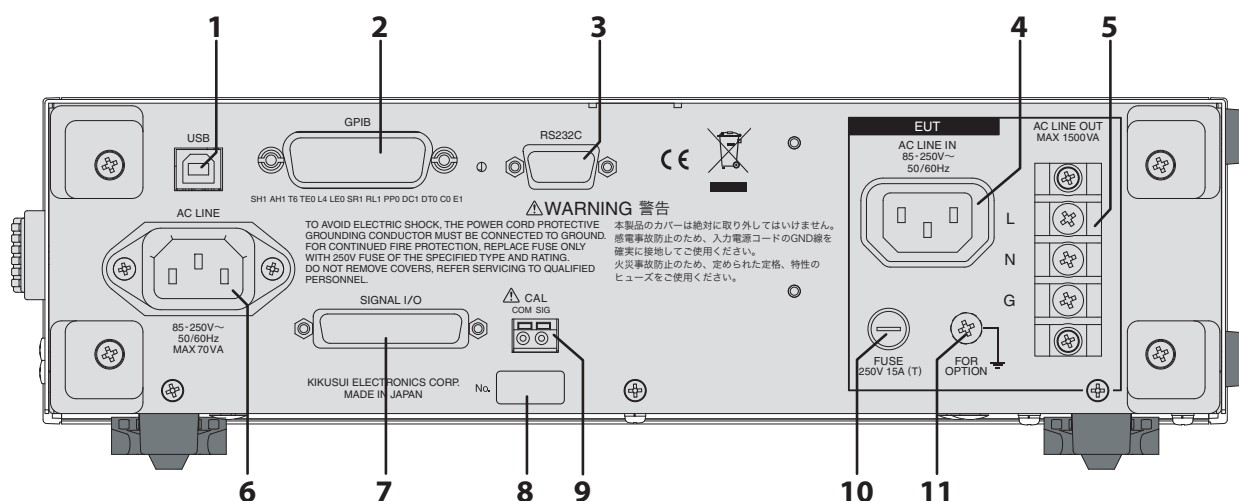

No.	Name	Function	See Page
1	USB connector	USB interface.	109
2	GPIB connector	GPIB interface.	107
3	RS232C connector	RS232C interface.	104
4	AC LINE IN	AC inlet for the EUT.	27
5	AC LINE OUT	Supplies the power applied to the AC inlet for the EUT.	42
6	AC LINE	AC inlet for the TOS3200.	27
7	SIGNAL I/O connector	External control signal connector.	96
8	Serial number	The serial number of the TOS3200.	—
9	CAL terminal	A terminal only used for calibration. Do not connect anything to this terminal.	—
10	FUSE	Input power fuse for the EUT.	166
11	FOR OPTION terminal	Connect the GND wire of the OT01-TOS Multi Outlet.	43

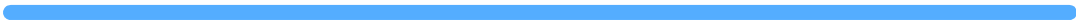
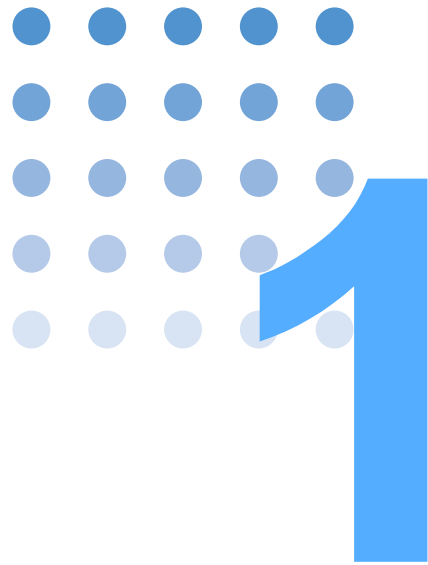

General Description

This chapter gives an overview and describes the features.

Product Overview

The TOS3200 Leakage Current Tester is used to measure the leakage current of the four tests*¹ that are required to secure the safety of electric equipment. The tester covers general electric and electronic equipment excluding medical equipment. Various measurement networks and wide-bandwidth measurement circuits are built in allowing the execution of tests meeting the requirements of safety standards such as IEC, EN, UL, VDE, and JIS as well as Electrical Appliance and Material Safety Law. Because the TOS3200 is equipped with an outlet and terminal block for supplying power, connecting the power line of the EUT is easy.

Features

● Measurement of TC and PCC conforming to IEC 60990*²

The TOS3200 is capable of measuring the TC using a measurement network (perception, reaction, let-go, and electric burn based on IEC 60990). In addition, the PCC can be measured simply by connecting the EUT to the TOS3200.

The internal voltmeter can measure the DC, true rms, and peak values and supports a measurement frequency up to 1 MHz for AC measurement, satisfying the recommended items of the standard.

● Equipped with eight measurement networks as standard (circuit networks representing the human body impedance)

The TOS3200 is equipped with eight measurement networks as standard including that of IEC 60990 allowing the measurement of the TC on most general electric and electronic equipment.*³

● Fault simulation of the power line supplied to the EUT

The TOS3200 supplies power not only to the EUT, but also allows you to carry out fault simulation easily as required by the standard such as protective grounding disconnection, power line disconnection, and polarity inversion.

● Program test that allows tests to be executed in sequence

Tests containing up to 100 steps can be executed consecutively by arbitrarily combining the TC and PCC measurements.

● Meter Measurement Mode with a voltmeter having the TC measurement and SELV detection functions

The TOS3200 is equipped with a meter measurement mode that separates the power line control and specializes in the measurement functions. It can be used in a similar manner as conventional analog leakage ammeter.

In Meter Measurement Mode, the voltage between measurement terminals can be measured in addition to the TC measurement. The TOS3200 is also equipped with a SELV detection function that warns using a DANGER lamp if the preset SELV voltage is exceeded. For example, this feature is convenient if you want to check whether the voltage is exceeding the safety extra low voltage (SELV); measure the TC to check whether the circuit is a limited current circuit; and use these results to judge whether the circuit is a hazardous live.

● CONV function that converts the measured value to a current at the desired supply voltage

Judgment can be performed by converting the measured power line voltage and the TC or PCC to the TC or PCC of a preset power line voltage.

CAL ALARM function that warns the expiration of the calibration period

A warning message will be generated when a preset calibration period passes. It is also possible to limit the use of the TOS3200 by activating the protection status when the period elapses.

Function for holding the maximum value during the measurement

The maximum TC or PCC during the measurement can be held. The maximum value can be measured even if the current fluctuates during the measurement.

Function for setting a wait time until the test is actually executed after starting the power supply

You can set a wait time for the test (time until the test is actually executed after starting the power supply to the EUT). This feature is useful if you want to measure the current after the EUT reaches the steady state avoiding the transient state of the EUT immediately after turning the power on.

Window comparator function that sets the upper and lower limits of judgement

You can set not only the upper reference of the TC or PCC but also the lower reference. This feature helps to discover breaks in test leads and mistakes in the setup/procedure and allows highly reliable tests.

Stores up to 100 test conditions

The test conditions of up to 100 individual tests (TC or PCC measurement) can be saved with a name.*⁵ Up to 100 sequence programs for program tests can also be saved with a name.*⁴ The number of the safety standard on which the test is based and the EUT model can be used as a name for the test conditions.

Stores the data for up to 50 test results

The test result, the date/time of the test, and the test conditions can be stored. Up to 50 results can be stored separately for individual tests and program tests.

Equipped with RS-232C, USB, and GPIB as standard

The TOS3200 is equipped with RS-232C, USB, and GPIB as standard. You can control test conditions and read the measured values and test results through a PC or a sequencer.

- *1 Withstanding Voltage Test, Insulation Resistance Test, Earth Continuity Test, and Leakage Current Test
- *2 IEC 60990: Methods of measuring TC and PCC
The current that is referred to as the "leakage current" is divided into TC (current that flows when a human being touches the electric equipment) and PCC (current that flows through the protective conductor of a Class I equipment).
- *3 Medical equipment is not supported.
- *4 Among the 100 presets, test conditions of TC conforming to the safety standards are stored to presets 00 to 50 in advance. These presets can be recalled and used in the TC test.
- *5 Up to 100 steps in a program and up to 500 steps total in all programs.

Options

The following options are available for the TOS3200.
For details on the options, contact your Kikusui agent or distributor.

Rack Mounting Option

Item	Model	Notes
Rack mount adapter	KRA3-TOS	Inch rack EIA standard
	KRA150-TOS	Milli rack JIS standard

This option allows the terminal block for the EUT on the rear panel to be used from the front panel making it easy to connect the EUT even after the TOS3200 is rack mounted.

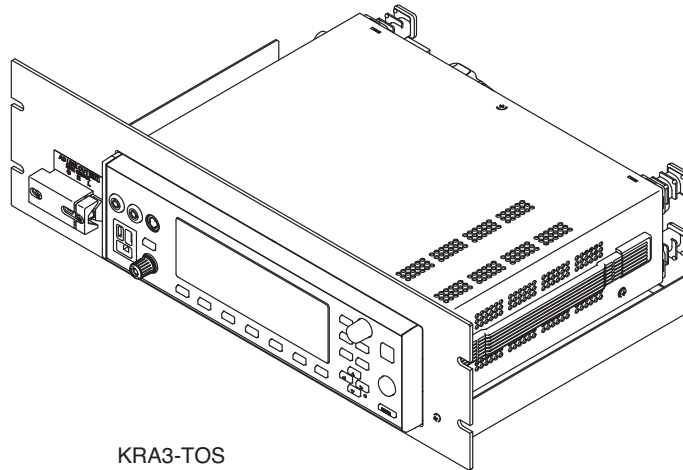

KRA3-TOS

Test Probe

See p. 49

A test probe can be used in place of the test lead in the TC measurement. It provides fingertip control to start the test.

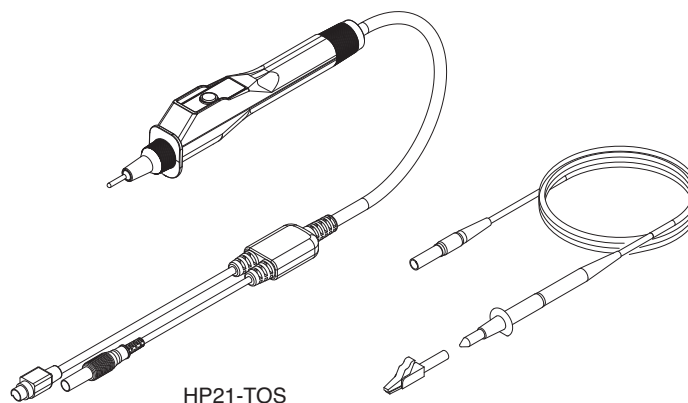

HP21-TOS

Multi Outlet

See p. 43

This option expands the outlet on the front panel. It allows popular plugs around the world to be connected.

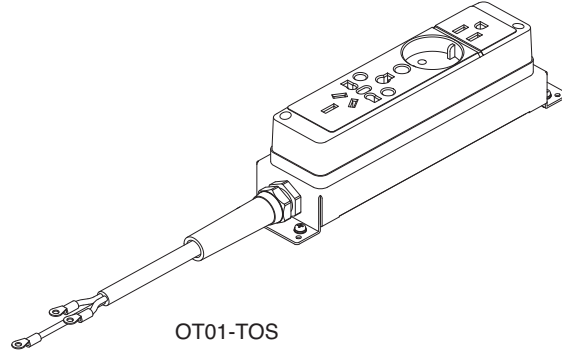





Installation and Preparation

This chapter describes the procedures of unpacking and preparation of the TOS3200 before use.

Checking the Package Contents

When you receive the product, check that all accessories are included and that the accessories have not been damaged during transportation.

If any of the accessories are damaged or missing, contact your Kikusui agent or distributor.

We recommend that you keep all packing materials, in case the product needs to be transported at a later date.

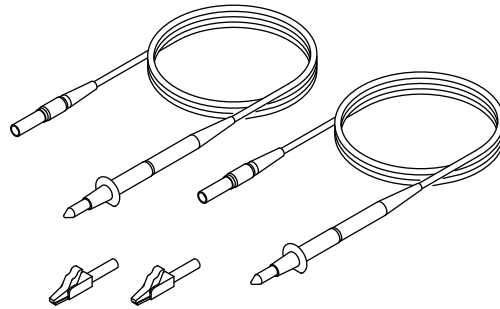

- Test lead (with alligator clip)
(red and black, one of each)
[TL21-TOS]

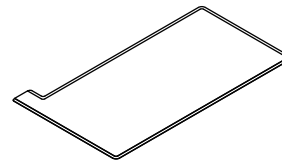

- Flat probe (1 pc.)
[FP01-TOS]



- Spare fuse (1 pc.)
[99-00-0441]

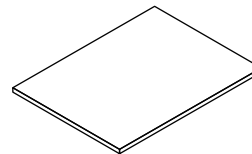

- Operation manual
(this manual, 1 pc.)
[Z1-004-482]

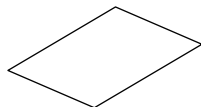

Affix the label to the top panel
or the like for reference.

- Circuit principle diagram label (1 pc.)
[A8-900-473]

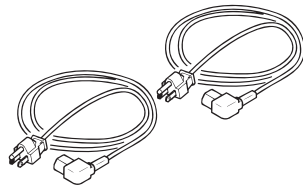

Rating: 125 V, 10 A
Plug: NEMA5-15
[85-AA-0003]

or

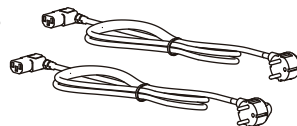

Rating: 250 V, 10 A
Plug: CEE7/7
[85-AA-0005]

or

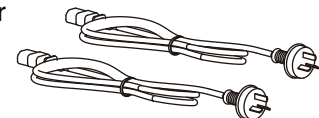

Rating: 250 V, 10 A
Plug: GB1002
[85-10-0790]

- Power cord (2 pc.)

The power cord that is provided varies depending on the destination for the product at the factory-shipment.

Fig. 2-1 Accessories

Precautions Concerning Installation Location

Be sure to observe the following precautions when installing the product.

- **Do not use the product in a flammable atmosphere.**

To prevent explosion or fire, do not use the product near alcohol, thinner or other combustible materials, or in an atmosphere containing such vapors.

- **Avoid locations where the product is exposed to high temperature or direct sunlight.**

Do not install the product near a heater or in areas subject to drastic temperature changes.

Operating temperature range: 0 °C to +40 °C (+32 °F to +104 °F)

Storage temperature range: -20 °C to +70 °C (-4 °F to +158 °F)

- **Avoid humid environments.**

Do not install the product in high-humidity locations near a boiler, humidifier, or water supply.

Operating humidity range: 20 %rh to 80 %rh (no condensation)

Storage humidity range: 0 to 90 %rh (no condensation)

Condensation may occur even within the operating humidity range. If this happens, do not use the product until the condensation dries up completely.

- **Be sure to use the product indoors.**

This product is designed for safe indoor use.

- **Do not install the product in a corrosive atmosphere.**

Do not install the product in a corrosive atmosphere or in environments containing sulfuric acid mist, etc. This may cause corrosion of various conductors and bad contacts of connectors inside the product leading to malfunction and failure, or in the worst case, a fire.

- **Do not install the product in a dusty location.**

Accumulation of dust may lead to electric shock or fire.

- **Do not use the product where ventilation is poor.**

Secure adequate space around the product so that air can circulate around it.

- **Do not place objects on the product.**

Placing heavy objects on top of the product may cause failures.

- **Do not install the product on an inclined surface or location subject to vibrations.**

The product may fall or tip over causing damages and injuries.

- **Do not use the product in a location where strong magnetic or electric fields are nearby or a location where large amount of distortion and noise is present on the input power supply waveform.**

The product may malfunction.

Using the Stand

The stand is used to tilt the front panel for easier viewing of the screen and improving the operability of the keys.

Pull and flip over the stand underneath at the front until it clicks in place.

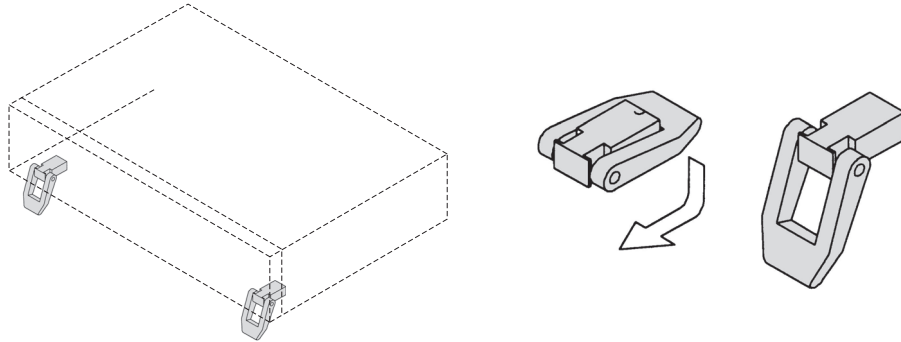

Fig. 2-2 Using the stand



CAUTION When using the stand, do not place objects on top of the product or apply downward force from the top of the product. To do so may cause the stand to break.

Precautions for Moving the Product

Note the following points when moving or transporting the product to the installation location.

Turn off the POWER switch.

Moving the product with the power is turned on may cause electric shock or damage to it.

Disconnect all wiring.

Moving the product with the cables connected may cause wires to break or injuries due to the product falling over.

When transporting the product, be sure to use the original packing materials.

Otherwise, damage may result from vibrations or from the product falling during transportation.

Be sure to include this manual.

Connecting the Power Cord



- This product is an IEC Safety Class I equipment (equipment with a protective conductor terminal). To prevent electric shock, be sure to ground (earth) the unit.
- This product is grounded through the ground wire of the power cord. Be sure to connect the power plug to an outlet with an appropriate earth ground.



- Use the supplied power cord to connect to the AC line.
If the supplied power cord cannot be used due to the rated voltage or the plug shape, have the cord replaced with an appropriate power cord of length 3 m or less by a qualified engineer. If obtaining a power cord is difficult, consult your Kikusui agent or distributor.
- In an emergency, the power cord with a plug may be used to disconnect the product from the AC line in an emergency. Connect the plug to an easily accessible power outlet so that the plug can be removed from the outlet at any time. Be sure to allow enough space around the power outlet.
- Do not use the supplied power cord on other instruments.

This product is an equipment of IEC Overvoltage Category II (energy-consuming equipment supplied from the fixed installation).

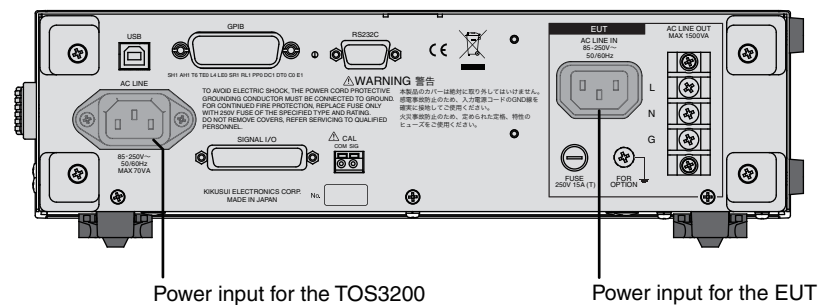

Fig. 2-3 AC inlet

Connecting the Power Cord for the TOS3200

- 1** Turn the **POWER** switch off.
- 2** Check that the **AC** power line complies with the input rating of the **TOS3200**.
The voltage that can be applied is any of the nominal power supply voltages in the range of 100 Vac to 240 Vac. The frequency is 50 Hz or 60 Hz.
- 3** Connect the power cord to the **AC** inlet (**AC LINE**) on the rear panel, and connect the power cord plug to an outlet with proper grounding.

Connecting the Power Cord for the EUT



The rated current of the supplied power cord is 10 A. To prevent fire, replace the power cord with an appropriate one if the input current to the EUT exceeds 10 A.



If you are using the TOS3200 in Meter Mode, you do not have to connect the power cord for the EUT.

The power to the EUT is supplied through the TOS3200. The input rating of the EUT must meet the input rating of the power input to the EUT of the TOS3200.

- Input voltage range: 85 V to 250 V
- Frequency: 50 Hz or 60 Hz
- Maximum power: 1500 VA

- 1** Check that the **AC** power line to be connected complies with the input rating of the power input for the EUT above.
- 2** Connect the power cord to the **AC** inlet (**AC LINE IN**) on the rear panel, and connect the power cord plug to an outlet with proper grounding.

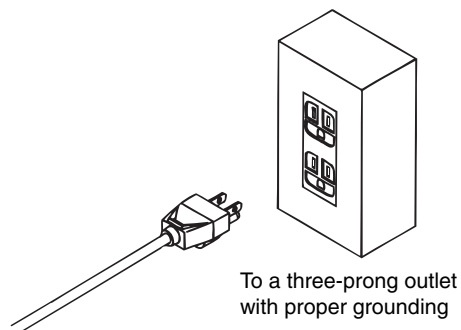

Fig. 2-4 Plug connection

Turning the Power On

Turning the POWER Switch On

2

- 1 Press the POWER switch to turn the power on (|).
- 2 Check the firmware version (Ver x.xx) that appears on the screen.

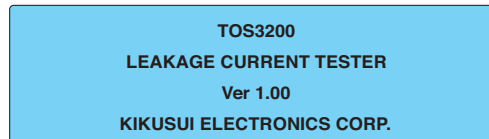

See p. 196

When you turn the POWER switch on for the first time, the TC measurement screen (TC1/2) will appear after the firmware version (factory default setting).

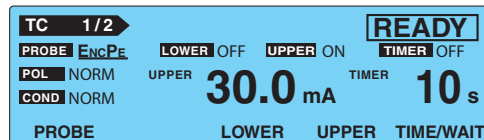

Because the TOS3200 stores the conditions immediately before the POWER switch is turned off, the TOS3200 starts up using the conditions that existed when the POWER switch was turned off the last time.

System clock

The TOS3200 manages the calibration date using the internal system clock. If the preset calibration period is due when the power is turned on, the message “CAL DATE EXPIRED” will appear on the screen.



See p. 164

For the procedure to set the system clock and the remedy when the calibration period expires, see “Time Settings and Calibration Management”.

Turning the POWER Switch Off



To prevent damage to the EUT, be sure to turn off the power switch of the EUT first and then the power switch of the TOS3200 if the power cord of the EUT is connected to the TOS3200.

Press the POWER switch to turn the power off (O).

The TOS3200 stores the panel settings immediately before the POWER switch is turned off. If the POWER switch is turned off immediately after changing the settings, the last settings may not be stored.

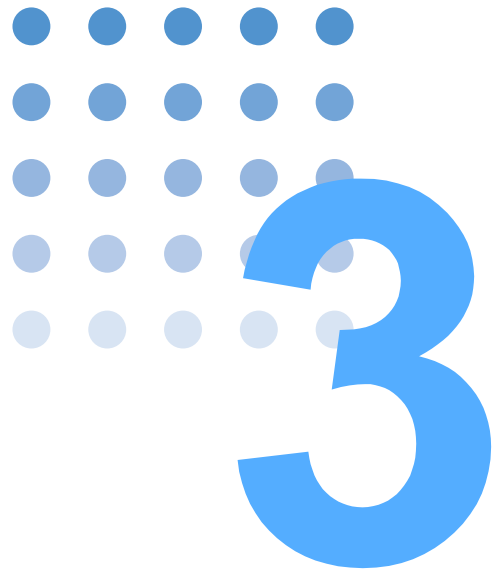

Panel Control Basics

This chapter explains how to select items on the screen and how to enter values.

Screen Configuration

The screen consists of the following four areas.

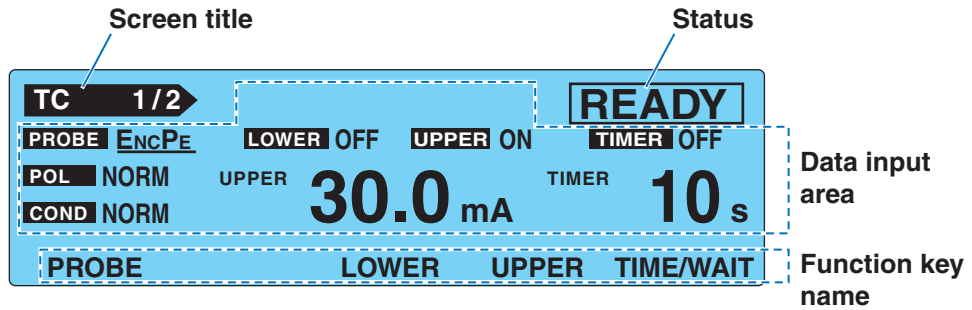

See p. 196

The screen above is the initial screen (factory default settings) that appears when you turn the POWER switch for the first time. To reset the TOS3200 to factory default settings, turn on the POWER switch while holding down the SHIFT key.

Screen title

Indicates the screen that is currently displayed.

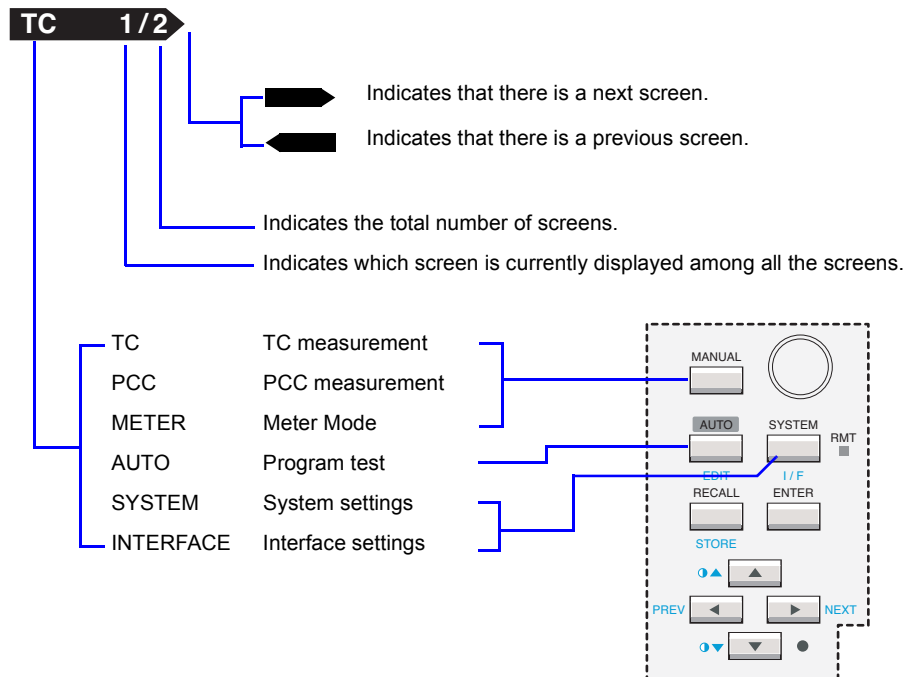

Status

Indicates the present status of the TOS3200.

READY	Indicates that the TOS3200 is ready to start the test.
WAIT	Indicates that the TOS3200 is waiting for the test.
TEST	Indicates that the test is in progress.
PASS	Indicates that the measured current was within the reference range.
↑FAIL	Indicates that a current greater than or equal to the upper reference was measured.
↓FAIL	Indicates that a current less than or equal to the lower reference was measured.
↕FAIL	Indicates that the enclosure is grounded in the earthing check.*1
EDIT	Indicates that the sequence program is being edited.
PROTECTION	Indicates that the protection function is activated.*2

*1 Executed in the ENCLIV or ENCNEU test of the TC measurement.

*2 You will not be able to use the TOS3200 if the protection function is activated. Eliminate the cause of the protection status by referring to "Protection Function".

See p. 204

Data input area

This area is used to enter items such as test conditions, sequence programs, and system settings.

The selected item is indicated with a underscore.

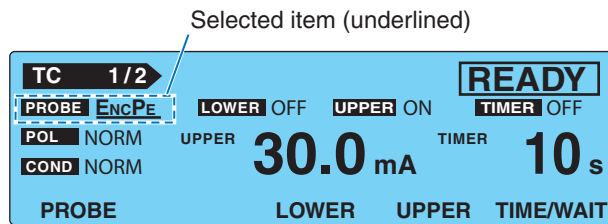

Function key name

The available functions are displayed above function keys F1 to F5.

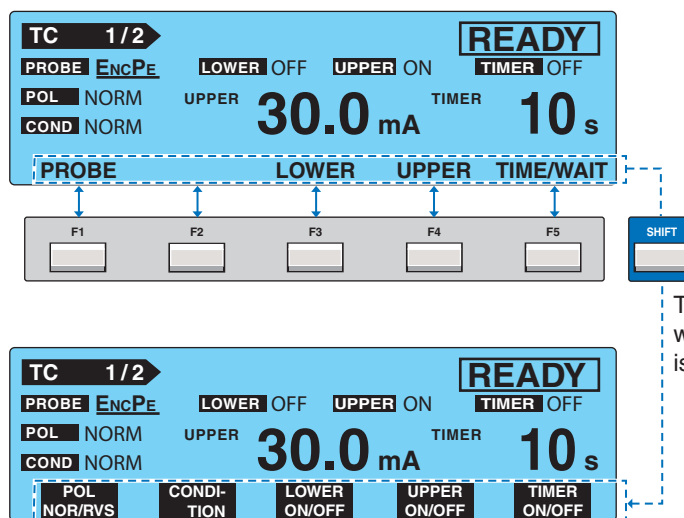

This display is shown while the SHIFT key is held down.

Panel Control

Switching the Screen

Each screen consists of multiple screens.

To display the next screen, press the NEXT (SHIFT+▶) key.

To display the previous screen, press the PREV (SHIFT+◀) key.

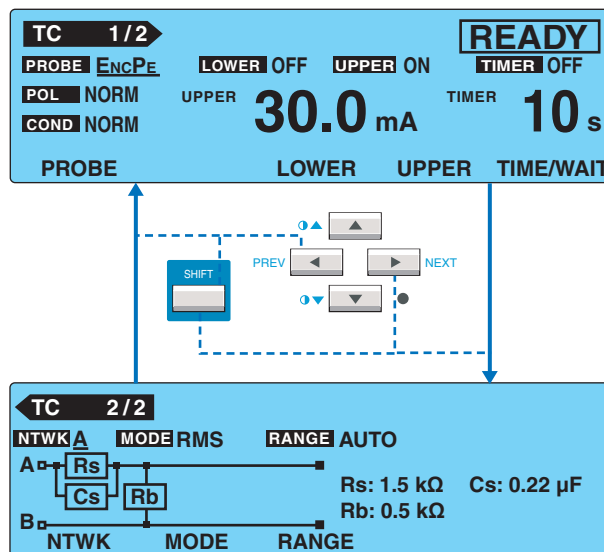

On the SYSTEM screen, <NEXT> (next screen) and <PREV> (previous screen) are assigned to the function keys.

Selecting Items

There are two ways to select items.

- Move the underscore to the item you want to select using the arrow keys (▲▼◀▶).

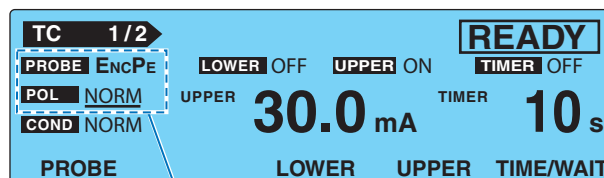

Press the ▼ key once when PROBE is selected to select POL.

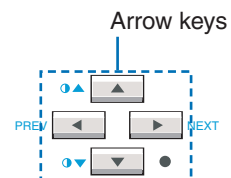

- Press the key corresponding to the function key name you want to select. If the item you want to select is not displayed, press the corresponding key while holding down the SHIFT key.

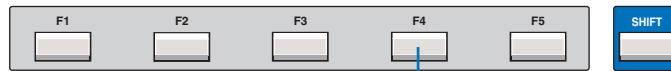
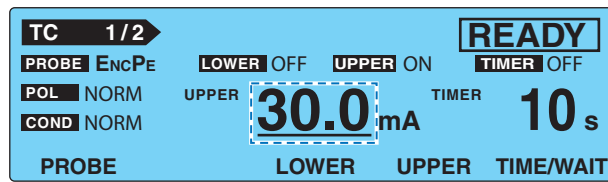

Press F4 to select UPPER (upper reference).

Entering Data

- You can set the value for the item with an underscore by turning the rotary knob.

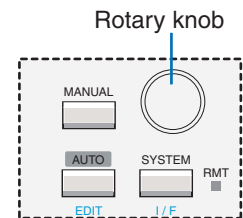
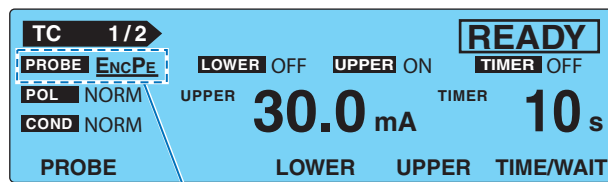

Turn the rotary knob to select the probe from ENCPE, ENCENC, ENCLIV, and ENCNEU.

- Depending on the item, you can enter the value by pressing a function key while holding down the SHIFT key to switch the selection.

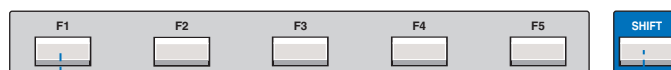
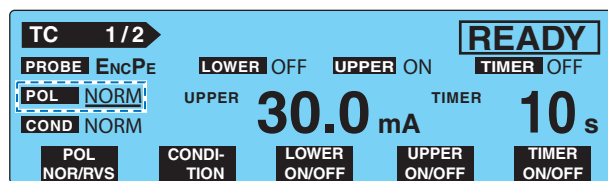

Press F1 while holding down the SHIFT key to select POL (NOR or RVS).

Adjusting the Screen Brightness

See p. 200

You can set the screen brightness to any of the 11 levels (0 to 10).

Press the **▲** (SHIFT+**▲**) key to increase the brightness and the **▼** (SHIFT+**▼**) key to decrease the brightness. On the SYSTEM screen, you can adjust the brightness while viewing the setting.

- SYSTEM1/5>CONTRAST

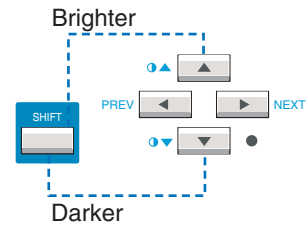

Key Lock

The key lock function prevents the test conditions from being changed mistakenly by the key operation.

Press the KEY LOCK (SHIFT+LOCAL) key to lock the panel settings.

Only the START and STOP switches are enabled on the panel.

The message "KEY LOCK" is displayed on the screen while the key lock is enabled.

To release the key lock, press the KEY LOCK (SHIFT+LOCAL) key again.

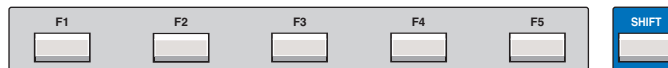
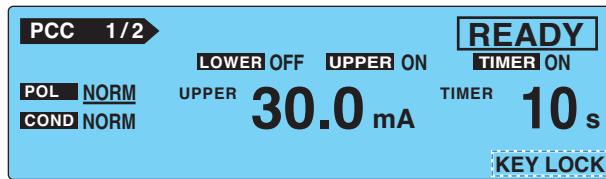

Selecting the Operation Mode

Single Tests (TC/PCC/METER)

The TOS3200 has three operation modes. Because each mode is independent, the TOS3200 can be used in any single operation mode.

A measurement in any of the following modes is called a single test.

- TC Measurement Mode
- PCC Measurement Mode
- Meter Mode (METER)

Each operation mode consists of two screens. Each time you press the MANUAL key, the screen changes as follows:

- When the first screen (1/2) is selected

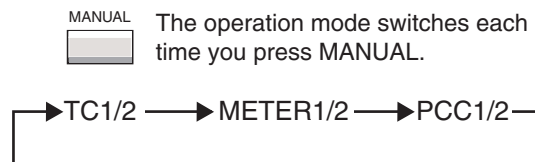

- When the second screen (2/2) is selected

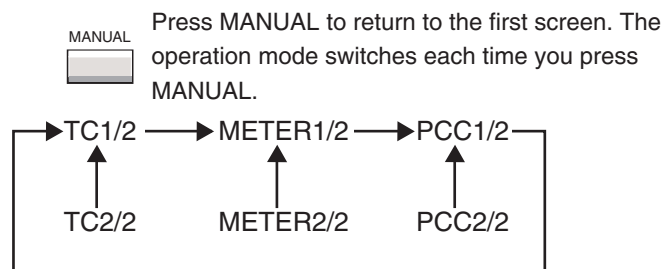

Program Tests (AUTO)

 p. 75

You can also execute program tests that combine the TC measurement and PCC measurement modes. To select the program test, press the AUTO key. For details, see “Program Test”.

Panel Memory

You can store up to 100 presets of test conditions.

Test conditions that can be stored

- Settings on the TC measurement screen (TC1/2 and 2/2)
- Settings on the PCC measurement screen (PCC1/2 and 2/2)

Each memory can store either of the settings above. The settings of a specific mode are stored by carrying out the storage operation with the screen of the operation mode that you want to store.

Panel memory status

STO	Indicates that the storing operation is in progress. A condition in which the area for storing the present settings has not been determined.
MEM	A condition in which the panel memory to be stored or recalled has been set.
RCL	Indicates that the recall operation is in progress. A condition in which the panel memory to be recalled has not been determined.

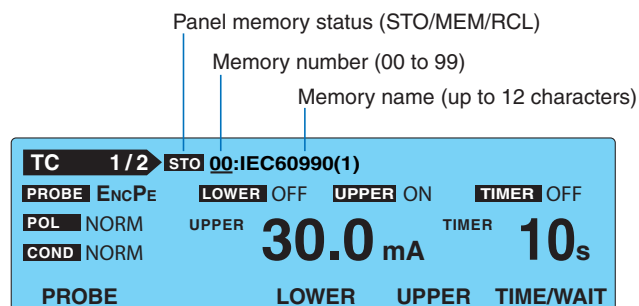

Preset panel memories

Test conditions of TC measurement conforming to various safety standards are written in advance to memory numbers 00 to 50. Select the memory number according your test application.

For details on the written contents, see “Default Values of the Panel Memory”.

See p. 198

Storing to the Test Conditions

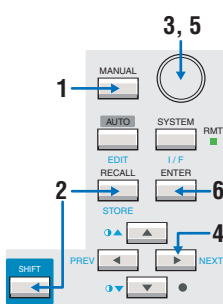

- 1** Press the **MANUAL** key to display the screen of the operation mode you want to store (TC or PCC measurement), and set the test conditions.
- 2** Press the **STORE (SHIFT+RECALL)** key.
“STO” followed by “memory number: memory name” are displayed to the right of the screen title.
- 3** Use the rotary knob to set the memory number (00 to 99) of the test conditions you want to store.
To cancel the storage operation, press the ▲ or ▼ key.
- 4** Press the ► key to move the cursor to the memory name.
- 5** Use the rotary knob to enter the name.
Up to 12 of the characters shown in Table 3-1 can be entered.
- 6** Press the **ENTER** key to store the test conditions to the memory number.
When the storage is complete, the characters “STO” will change to “MEM.”

Table 3-1 Characters that can be entered

	0	1	2	3	4	5	6	7	8	9	A	B	C	D	E	F
20		!	"	#	\$	%	&	'	()	*	+	,	-	.	/
30	0	1	2	3	4	5	6	7	8	9	:	;	<	=	>	?
40	@	A	B	C	D	E	F	G	H	I	J	K	L	M	N	O
50	P	Q	R	S	T	U	V	W	X	Y	Z	[\]	^	_
60	`	a	b	c	d	e	f	g	h	i	j	k	l	m	n	o
70	p	q	r	s	t	u	v	w	x	y	z	{		}	~	

Double quotation mark (22H), single quotation mark (27H), comma (2CH), and @ (40H) cannot be entered.

Recalling from the Test Conditions

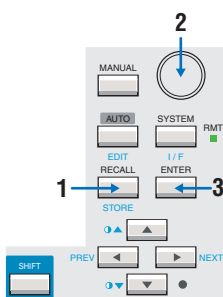

- 1** Press the **RECALL** key.
“RCL” followed by “memory number: memory name” are displayed to the right of the screen title.
- 2** Use the rotary knob to set the memory number (00 to 99) of the test conditions you want to recall.
To cancel the recall operation, press the ▲ or ▼ key.
- 3** Press the **ENTER** key to recall the test conditions of the specified memory number.
When the recall is complete, the characters “RCL” will change to “MEM.”

If you change the test conditions that you recalled, the memory number will disappear. The memory number will not be displayed again even if you set the test conditions back to the original conditions.



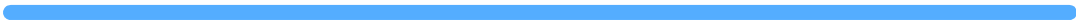

TC and PCC Tests

This chapter explains the procedures from setting the test conditions to saving the test results for the touch current and protective conductor current measurement tests.

Connecting the EUT

Using the Output on the Front Panel

Connect the power cord of the EUT to the outlet (AC LINE OUT) on the front panel.

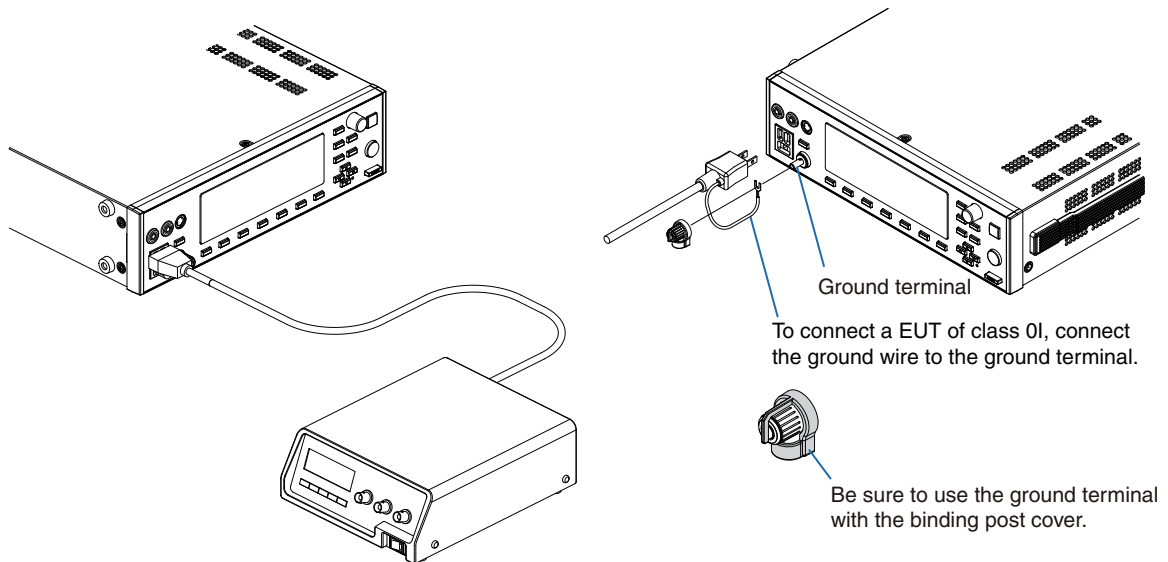

Fig. 4-1 Connection for the PCC measurement



Electric shock may occur. In case of measuring the touch current in the condition of “Earth line disconnected status” of the EUT, a hazardous voltage may apply to the ground terminal. Do not touch the ground terminal while the test is in progress.

The outlet on the front panel is a NEMA5-15 outlet for 100-V systems. However, if the plug cannot be connected physically (as may be the case with some AC adapters), use a power strip or the like.

See p. 42

Use the terminal block on the rear panel to connect a plug for 200-V systems. You can connect many of the popular plugs around the world by connecting the optional multi outlet to the terminal block.

Using the Terminal Block on the Rear Panel

If the power cord plug of the EUT does not match the output on the front panel, use the AC LINE OUT terminal block on the rear panel.

The outlet and the terminal block are connected in parallel inside the TOS3200. Do not connect EUTs to both the outlet and the terminal block at the same time.



- Electric shock may occur. Be sure to remove the power cord from the AC inlet for the EUT before making the connection.
- The voltage applied to the AC inlet for the EUT appears at the AC LINE OUT terminal block. If you are not using the terminal block, cover the terminals with the terminal cover.

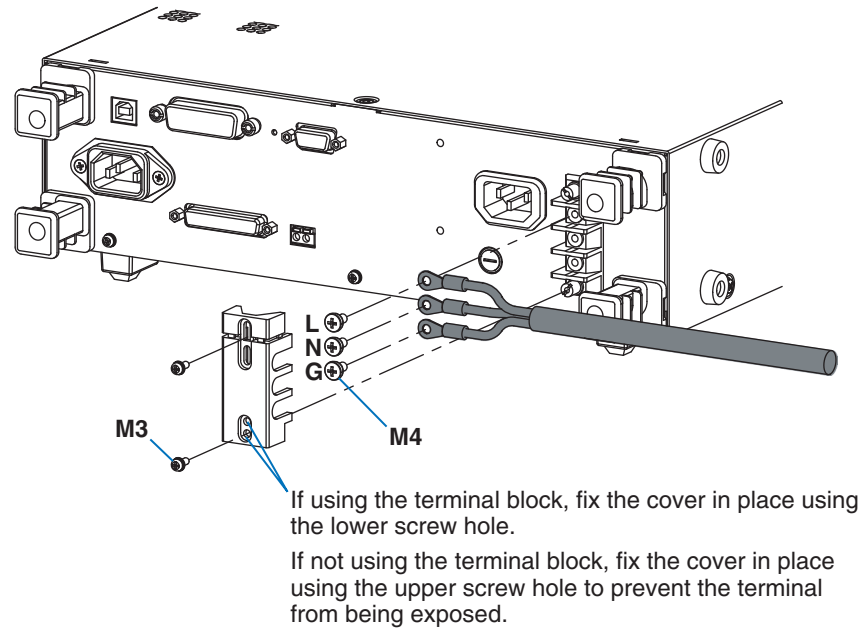

Fig. 4-2 Connecting to the AC LINE OUT terminal block

Using the Optional Multi Outlet (OT01-TOS)

You can connect ordinary plugs available around the world in case the optional Multi Outlet (OT01-TOS) is used. For details, see the OT01-TOS Operation Manual.

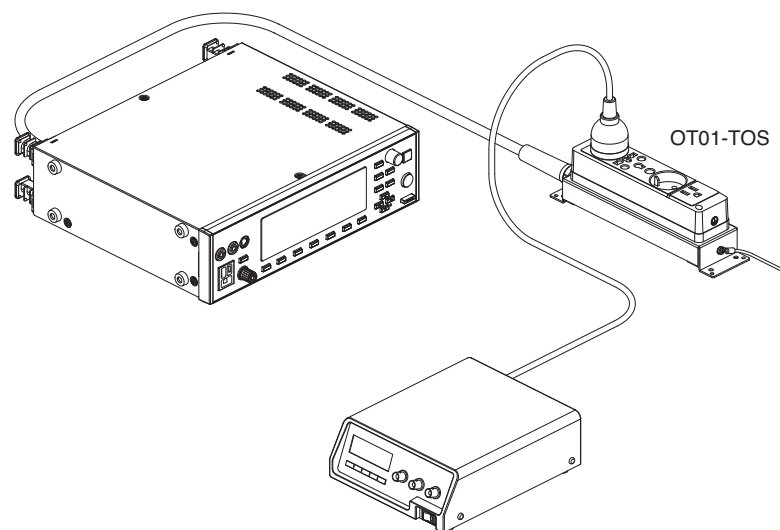

Fig. 4-3 Application example of the OT01-TOS

Checking the EUT Operation

The power is supplied through the power line for the EUT only during the test. To check the EUT operation before the test, use the LINE ON key.

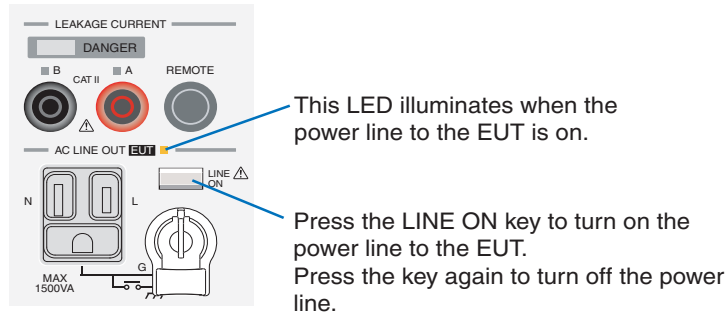

Fig. 4-4 LINE ON key

NOTE

Check the connection of the power line of the EUT before pressing the LINE ON key. If the LINE ON LED is illuminated, the power for the EUT is supplied to the outlet on the front panel and the AC LINE OUT terminal block on the rear panel.

OVER LOAD PROTECTION indication

See p. 204

If a current greater than or equal to 15.75 A flows through the power line of the EUT or the power consumption of the EUT exceeds 1500 VA, the overload protection will be activated, and the power line will be shut off. If this happens, the screen will display "OVER LOAD PROTECTION," and the TOS3200 will enter the protection status. To release the protection status, disconnect the EUT, and press the STOP switch.

Connecting the Test lead (TL21-TOS)

The test lead is used in the TC measurement.



Electric shock may occur. Do not touch the tip of the lead while using the test lead.

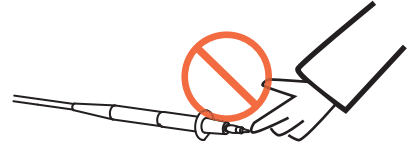

The red or black test lead is used separately according to the type of TC to be measured. The red and black test leads are connected to measurement terminals A and B, respectively.

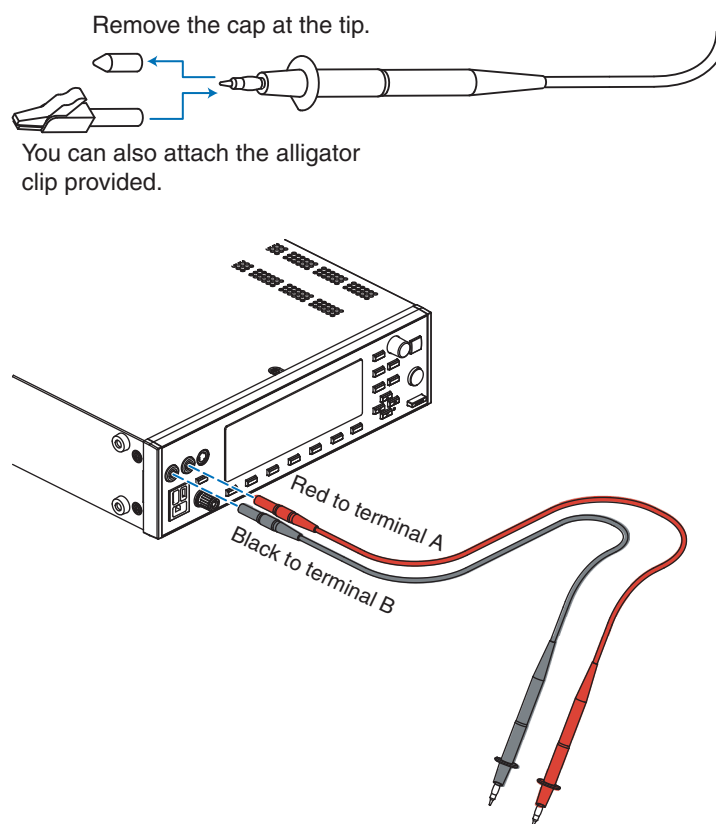

Fig. 4-5 Test lead usage

Connecting the Test lead (TL21-TOS) (Cont'd)

The test lead connection varies depending on the type of TC to be measured and the EUT class.

Table 4-1 Test lead connections for the type of TC measurement

Setting		Connection destination of the test lead	
PROBE	COND	Class I equipment Class 0I equipment	Class II equipment
ENCPE	NORM	Connect test lead A to a part of the enclosure that is not connected to the protective ground [Connection a of Fig. 4-7].	Connect test lead A to the enclosure.
	FLTNEU		
	FLTPE	Connect test lead A to a part of the enclosure that is not connected to the protective ground [Connection a of Fig. 4-7] or a part that is connected to the protective ground.	
ENCENC	NORM	Connect test leads A and B to parts of the enclosure that is not connected to the protective ground (two isolated locations) [Connection b of Fig. 4-7].	Connect test leads A and B to the enclosure (two isolated locations).
	FLTNEU		
	FLTPE	Connect test leads A and B to parts of the enclosure that is not connected to the protective ground (two isolated locations) [Connection b of Fig. 4-7] or to a part that is not connected to the protective ground and a part that is connected to the protective ground [Connection c of Fig. 4-7].	
ENCLIV		Connect test lead A to a part of the enclosure that is not connected to the protective ground [Connection a of Fig. 4-7].	Connect test lead A to the enclosure.
ENCNEU			

Test lead A: Test lead connected to measurement terminal A
 Test lead B: Test lead connected to measurement terminal B

If you select the PROBE item in the TC measurement screen (TC1/2), the LEDs located above the measurement terminals will illuminate for those that require the test leads to be connected.

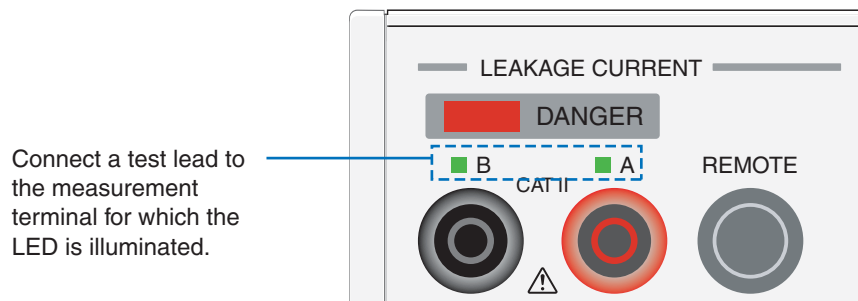

Fig. 4-6 LED connection indications

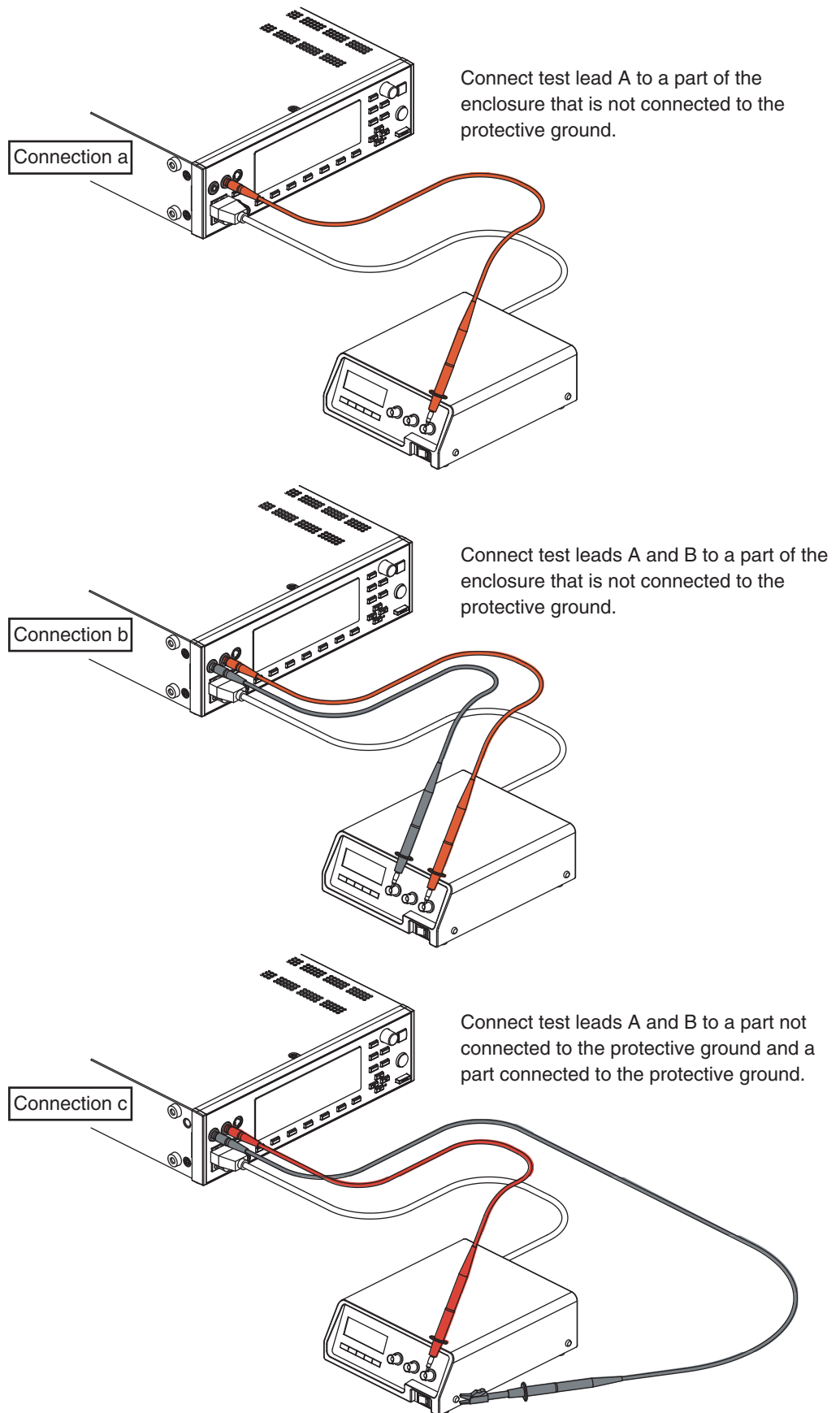

Fig. 4-7 Connection example for TC measurement

Using the Flat Probe (FP01-TOS)

The flat probe is a type of sheet that measures the TC when the enclosure is touched with the palm of one's hand. The size of the metal foil (10 cm × 20 cm) complies with IEC 60990.

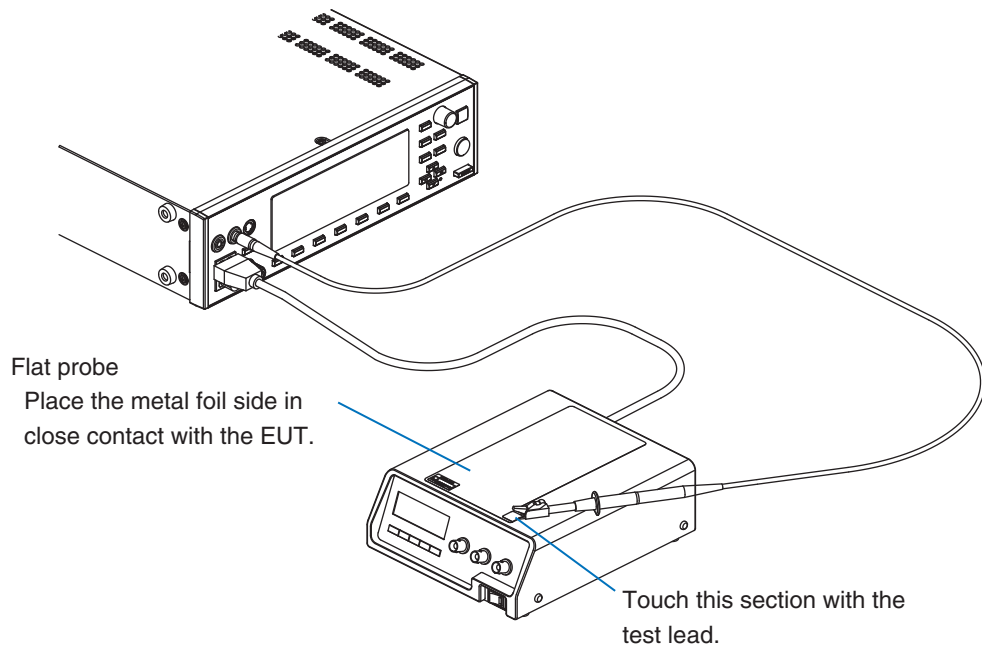

Fig. 4-8 Flat probe usage

Using the Optional Test Probe (HP21-TOS)

You can start the test from your fingertips if you use the optional test probe in place of the test lead. For details, see the HP21-TOS Operation Manual.

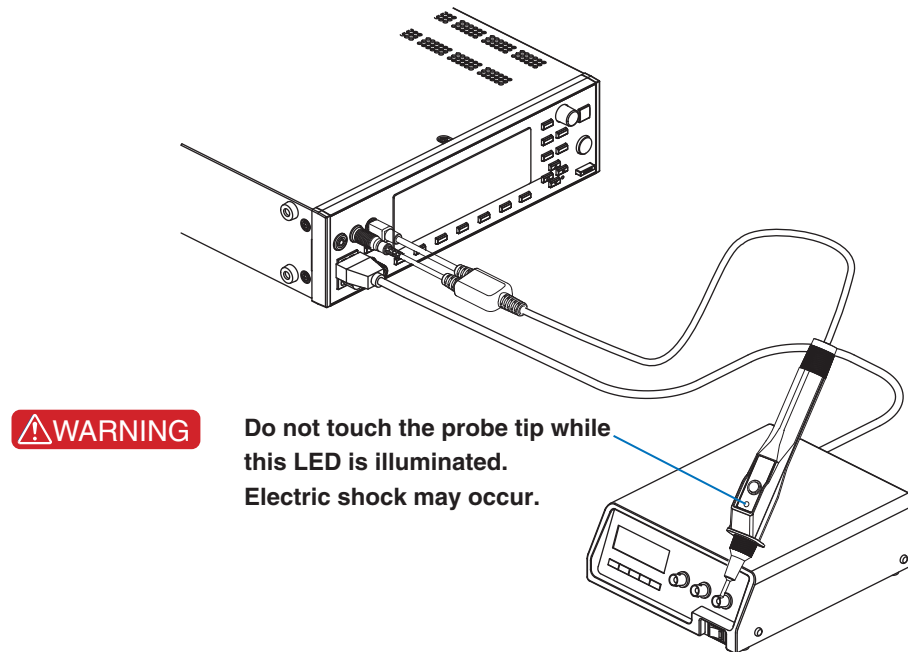

Fig. 4-9 Test probe usage

Measurement Check

The measurement check verifies the operation of the current measurement circuit of the TOS3200 by running a low current between measurement terminals A and B. Because this check is performed using the test lead, it also checks for disconnection of the test lead.

We recommend that you execute the measurement check before starting the measurements. For details, see "Measurement Check".

See p. 162

Judgment System

The TOS3200 judges PASS, L-FAIL, or U-FAIL with respect to a preset reference.

- **PASS** If the measured values are within the reference range up to the end of the test (TIMER 0 s), the TOS3200 will indicate PASS, and the test ends.
- **L-FAIL** If a current less than or equal to the lower reference is measured, the TOS3200 will indicate L-FAIL, but the test continues until the end of the test (TIMER 0 s).
- **U-FAIL** If a current greater than or equal to the upper reference is measured, the TOS3200 will indicate U-FAIL, and the test stops immediately.

Table 4-2 shows the judgments for measured values according to the TIMER, LOWER, and UPPER settings. Pass and L-FAIL are judged only if TIMER is ON.

Validity of the Lower Reference

Normally, the TC and PCC of the same EUT are within a specified range of the EUT, but if the current is extremely small, it cannot be measured. Specifying LOWER ON and setting the lower reference to a value slightly smaller than the range specific to the EUT help to detect a disconnection or a bad connection of the test leads. This allows more reliable tests.

Table 4-2 Judgment patterns

TIMER	LOWER	UPPER	Measured value distribution		judgment
			Lower reference	Upper reference	
ON	ON	ON	[Distribution within range]		PASS
			[Distribution above upper reference]		U-FAIL
			[Distribution below lower reference]		L-FAIL
			[Distribution below lower reference]		U-FAIL
	OFF	ON	[Distribution within range]		PASS
			[Distribution above upper reference]		U-FAIL
	ON	OFF	[Distribution within range]		PASS
			[Distribution below lower reference]		L-FAIL
	OFF	OFF	[Distribution within range]		PASS

TIMER	LOWER	UPPER	Measured value distribution		judgment
			Lower reference	Upper reference	
OFF	ON*1	ON	[Measured value distribution]		-
			[Measured value distribution]		U-FAIL
			[Measured value distribution]		-
			[Measured value distribution]		U-FAIL
	OFF	ON	[Measured value distribution]		-
			[Measured value distribution]		U-FAIL
	ON*1	OFF	[Measured value distribution]		-
			[Measured value distribution]		-
OFF	OFF	[Measured value distribution]		-	

*1. If TIMER is set to OFF, L-FAIL is not judged.

Test Wait Time and Judgment

You can set the time until the test actually starts after you press the START switch. Measured values during the test wait time are ignored and do not affect the judgment as shown in Fig. 4-10. For example, if the test wait time is set longer than the startup time of the EUT, the measured values in the steady-state condition of the EUT can be evaluated.

The maximum measured value is not held during the test wait time.

See p. 200

- SYSTEM1/5 > MEAS MODE > MAX

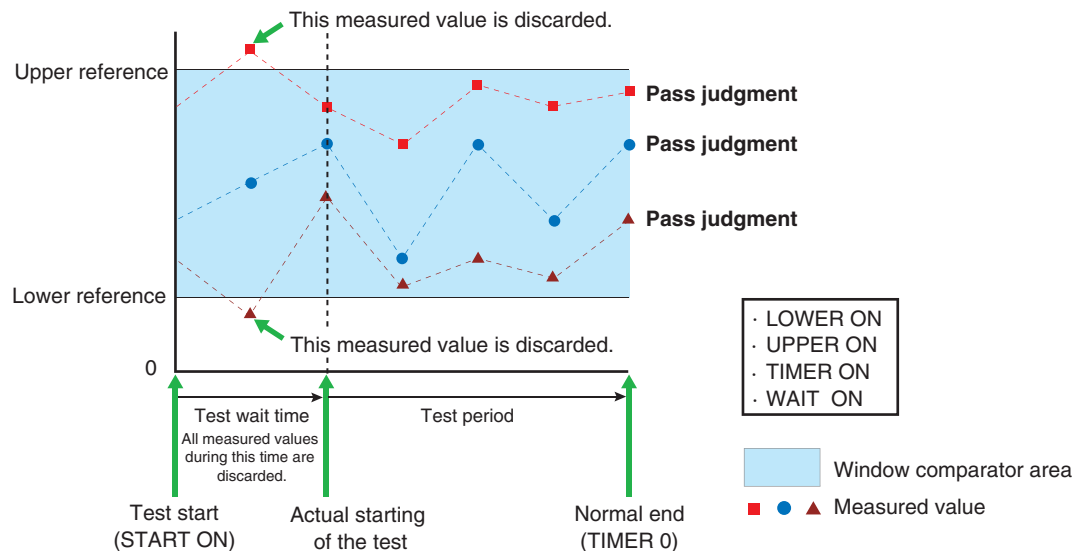
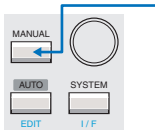

Fig.4-10 Measured values during the test wait time

Setting Test Conditions of the TC Measurement



Press the MANUAL key to display the TC measurement screen 1/2 (TC1/2).
The TC measurement screen consists of two screens (TC1/2 and 2/2).

See p. 31

For the procedure to select items and enter data, see “Panel Control Basics”.

See p. 42

For the procedure to connect the EUT, see “Connecting the EUT”.

Setup Items of TC1/2 (PROBE / POL / COND)

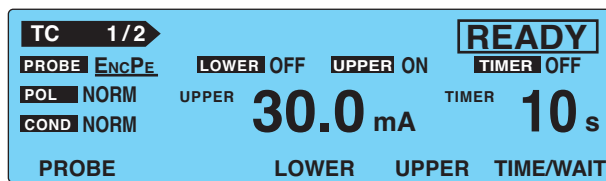

Item	Description	Panel operation
PROBE	Selects the connection destination of measurement terminals A and B.	PROBE (F1) key
	ENCPE*1 Between the enclosure and earth	
	ENCENC*1 Between two enclosures	Rotary knob
	ENCLIV Between the enclosure and power line (live)	
	ENCNEU Between the enclosure and power line (neutral)	
POL *2	Selects the polarity of the power line supplied to the EUT.	
	NORM Positive phase connection	POL NOR/RVS
	REVS Negative phase connection	(SHIFT+F1) ㊦
COND *2	Selects the single fault mode.	
	NORM Normal status	CONDITION
	FLTNEU Power line (neutral) disconnected status	(SHIFT+F2) key
	FLTPE*1 Earth line disconnected status	

See

Table 4-1 on p. 46

*1 The following combinations are invalid for Class II EUTs without the ground wire.

PROBE	COND
ENCPE	FLTPE
ENCENC	FLTPE

*2 If the PROBE item is set to ENCLIV or ENCNEU, the following items cannot be selected. NORM is selected regardless of the present setting.

Fig. 4-11 shows how the relays inside the TOS3200 switch depending on the settings of the PROBE, POL, and COND items.

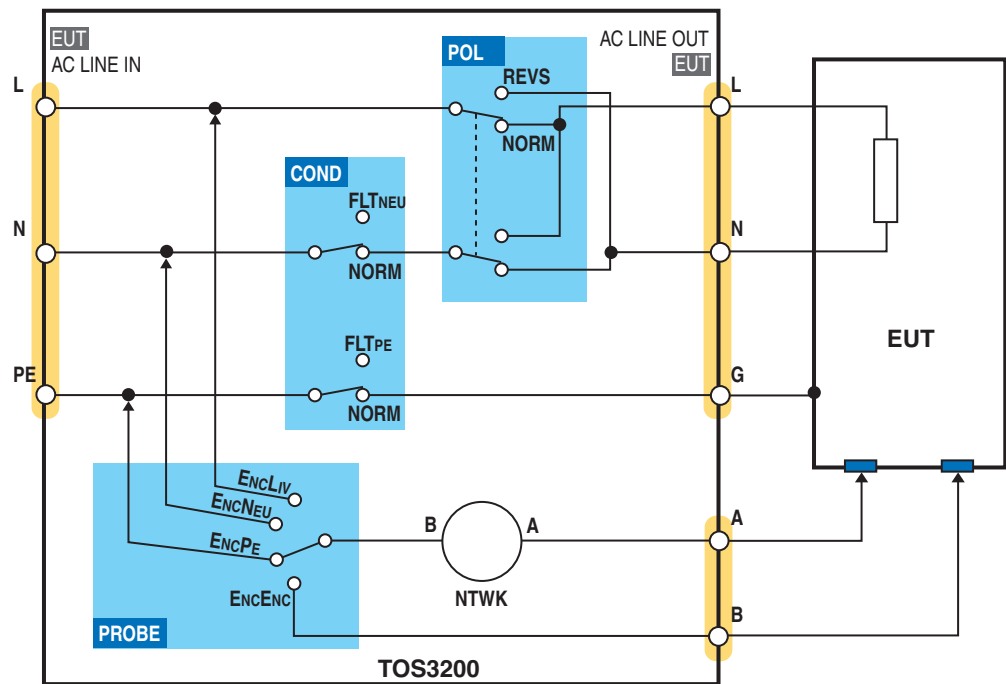

Fig. 4-11 Conceptual diagram of the TC measurement

Earthing check

If the PROBE is set to ENCLIV or ENCNEU, measurement terminal A is connected to the EUT enclosure (floating section) and terminal B of the measurement network is connected to the power line (L or N) inside the TOS3200 to execute the test. Therefore, if the EUT enclosure is grounded, a dangerous earth fault will result through the NTWK. It is also possible that measurement terminal A is connected to the grounded section of the enclosure by mistake. It is necessary to check that the measurement point is not grounded in advance to perform the test safely.

The earthing check automatically performs this check. When you press the START switch, the TOS3200 supplies a low current between measurement terminals A and earth before the actual test, measures this current, and checks the grounding of the measurement point. If the measurement point is grounded, “↓FAIL” (CONTACT FAIL) will be indicated on the screen, and the test will be aborted.

Both the U-FAIL and L-FAIL signals are delivered from the SIGNAL I/O connector.

To clear CONTACT FAIL, press the STOP switch.

See p. 96

CAUTION

If you connect the test lead to the measurement point after you press the START switch, the TOS3200 will judge that the measurement point is not grounded, and the earthing check will pass. If you do this, you cannot check mistakes in the connection. Be sure to connect the test lead to the measurement point first, and then press the START switch.

Setup Items of TC1/2 (LOWER / UPPER / TIMER / WAIT)

See p. 50

For a description of the LOWER, UPPER, and TIME/WAIT settings, see also “Judgment System”.

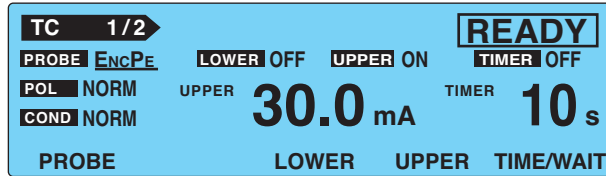

Item	Description	Panel operation
LOWER	Sets the lower limit of the judgment reference. If LOWER ON is specified and a current less than or equal to the lower reference is measured, L-FAIL judgment will result	LOWER (F3) key
	Lower reference	The selectable range varies depending on the NTKW (measurement network) and MODE (current measurement mode) settings on TC2/2. See Table 4-3. Rotary knob
	OFF	Disables the lower reference judgment. LOWER ON/OFF (SHIFT+F3) key
	ON	Enables the lower reference judgment.
UPPER	Sets the upper limit of the judgment reference. If UPPER ON is specified and a current greater than or equal to the upper reference is measured, U-FAIL judgment will result.	UPPER (F4) key
	Upper reference	The selectable range varies depending on the NTKW (measurement network) and MODE (current measurement mode) settings on TC2/2. See Table 4-3. Rotary knob
	OFF	Disables the upper reference judgment. UPPER ON/OFF (SHIFT+F4) key
	ON	Enables the upper reference judgment.
TIMER WAIT	Sets the test time (TIMER) or the test wait time (WAIT). If TIMER is selected, you can set the test time and TIMER ON/OFF. If WAIT is selected, you can set the test wait time and WAIT ON/OFF.	TIME/WAIT (F5) key
	Test time	Set the test time in the range of 1 s to 999 s. The test time will start when the test wait time elapses. Rotary knob
	TIMER OFF	The specified test time is discarded. Press the STOP switch to stop the test. TIMER ON/OFF (SHIFT+F5) key
	TIMER ON	The test will stop when the specified time elapses.
	Test wait time	Set the time until the test is actually started after the START switch is pressed (test wait time) in the range of 1 s to 999 s. Rotary knob
	WAIT OFF	The specified test wait time is discarded. WAIT ON/OFF (SHIFT+F5) key
WAIT ON	The actual test will start when the specified test wait time elapses.	

Table 4-3 Selectable range of LOWER/UPPER

MODE	NTWK A, B, B1,C	NTWK D, E	NTWK F	NTWK G
DC, RMS	30 μ A to 30.0 mA	30 μ A to 30.0 mA	30 μ A to 20.0 mA	30 μ A to 15.0 mA
PEAK	50 μ A to 90.0 mA	50 μ A to 45.0 mA	50 μ A to 30.0 mA	50 μ A to 22.5 mA

Blinking UP <= LOW indication

If the lower reference is set to a value greater than or equal to the upper reference in the LOWER ON condition, “UP <= LOW” will blink at the upper right of the screen to indicate that the setting is invalid.

Setup Items of TC2/2 (NTWK / MODE / RANGE)

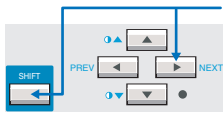

Press the NEXT (SHIFT+▶) key to display the TC measurement screen 2/2 (TC2/2).

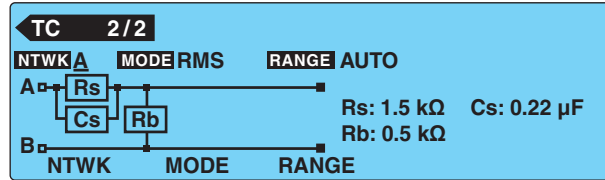

Item	Description	Panel operation
NTWK	Selects the measurement network.	NTWK (F1) key
A	(For IEC 60990) (1.5 kΩ // 0.22 μF) + 500 Ω	
B	(For IEC 60990) (1.5 kΩ // 0.22 μF) + 500 Ω // (10 kΩ + 22 nF)	
B1*1	(For IEC 60065) (1.5 kΩ // 0.22 μF) + 500 Ω // (10 kΩ + 22 nF)	
C	(For IEC 60990) (1.5 kΩ // 0.22 μF) + 500 Ω // (10 kΩ + (20 kΩ + 6.2 nF) // 9.1 nF)	NTWK (SHIFT+F1) key
D	1 kΩ	
E	1 kΩ // (10 kΩ + 11.225 nF + 579 Ω)	
F	1.5 kΩ // 0.15 μF	
G	2 kΩ	
MODE	Selects the current measurement mode.	MODE (F2) key
RMS	RMS measurement	
DC	DC measurement	MODE (SHIFT+F2) key
PEAK	Peak measurement	
RANGE	Selects the measurement range.	RANGE (F3) key
AUTO	Automatically switches the range according to the measured value.	
FIX	Fixes the range. The measurement range is determined by the upper reference, measurement network (NTWK), and current measurement mode (MODE) settings. See Table 4-4.	RANGE (SHIFT+F3) key

See p. 176

*1 Measures voltage U1 between the measurement network reference points.

Table 4-4 Determination of the measurement range

Measurement range	MODE	Upper reference			
		NTWK A, B, B1,C	NTWK D, E	NTWK F	NTWK G
Range 1	DC, RMS	30 μA to 600 μA	30 μA to 300 μA	30 μA to 200 μA	30 μA to 150 μA
	PEAK	50 μA to 850 μA	50 μA to 424 μA	50 μA to 282 μA	50 μA to 212 μA
Range 2	DC, RMS	601 μA to 6.00 mA	301 μA to 3.00 mA	201 μA to 2.00 mA	151 μA to 1.50 mA
	PEAK	851 μA to 8.50 mA	425 μA to 4.24 mA	283 μA to 2.82 mA	213 μA to 2.12 mA
Range 3	DC, RMS	6.01 mA to 30.0 mA	3.01 mA to 30.0 mA	2.01 mA to 20.0 mA	1.51 mA to 15.0 mA
	PEAK	8.51 mA to 90.0 mA	4.25 mA to 45.0 mA	2.83 mA to 30.0 mA	2.13 mA to 22.5 mA

Setting Test Conditions of the PCC Measurement

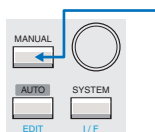

Press the MANUAL key to display the PCC measurement screen 1/2 (PCC1/2).
The PCC measurement screen consists of two screens, PCC1/2 and 2/2.

See p. 32

For the procedure to select items and enter data, see “Screen Configuration”.

See p. 42

For the procedure to connect the EUT, see “Connecting the EUT”.

Setup Items of PCC1/2 (POL / COND)

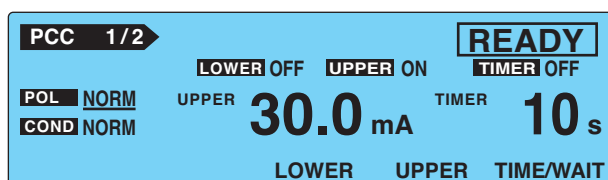

Item	Description	Panel operation
POL	Selects the polarity of the power line supplied to the EUT.	
	NORM Positive phase connection	POL NOR/RVS (SHIFT+F1) key
	REVS Negative phase connection	
COND	Selects the single fault mode.	
	NORM Normal status	CONDITION (SHIFT+F2) key
	FLTNEU Power line (neutral) disconnected status	

Fig. 4-12 shows how the relays inside the TOS3200 switch depending on the settings of the POL and COND items.

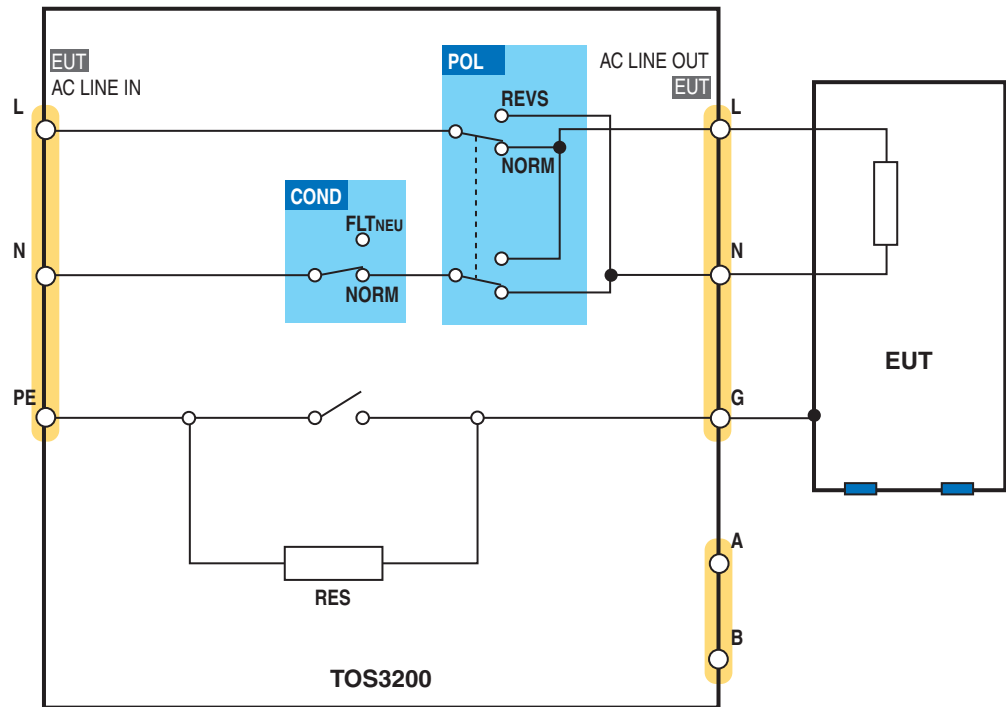
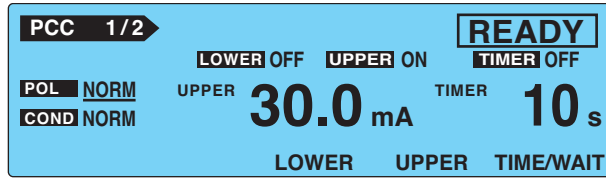

Fig. 4-12 Conceptual diagram of the PCC measurement

Setup Items of PCC1/2 (LOWER / UPPER / TIMER / WAIT)

See p. 50

For a description of the LOWER, UPPER, and TIME/WAIT settings, see also “Judgment System”.



Item	Description	Panel operation
LOWER	Sets the lower limit of the judgment reference. If LOWER ON is specified and a current less than or equal to the lower reference is measured, L-FAIL judgment will result.	LOWER (F3) key
	Lower reference	The selectable range varies depending on the MODE (current measurement mode) setting on PCC2/2. See Table 4-5. Rotary knob
	OFF	Disables the lower reference judgment. LOWER ON/OFF (SHIFT+F3) key
	ON	Enables the lower reference judgment.
UPPER	Sets the upper limit of the judgment reference. If UPPER ON is specified and a current greater than or equal to the upper reference is measured, U-FAIL judgment will result.	UPPER (F4) key
	Upper reference	The selectable range varies depending on the MODE (current measurement mode) setting on PCC2/2. See Table 4-5. Rotary knob
	OFF	Disables the upper reference judgment. UPPER ON/OFF (SHIFT+F4) key
	ON	Enables the upper reference judgment.
TIMER WAIT	Sets the test time (TIMER) or the test wait time (WAIT). If TIMER is selected, you can set the test time and TIMER ON/OFF. If WAIT is selected, you can set the test wait time and WAIT ON/OFF.	TIME/WAIT (F5) key
	Test time	Set the test time in the range of 1 s to 999 s. The test time will start when the test wait time elapses. Rotary knob
	TIMER OFF	The specified test time is ignored. Press the STOP switch to stop the test. TIMER ON/OFF (SHIFT+F5) key
	TIMER ON	The test will stop when the specified time elapses.
	Test wait time	Set the time until the test is actually started after the START switch is pressed (test wait time) in the range of 1 s to 999 s. Rotary knob
	WAIT OFF	The specified test wait time is ignored. WAIT ON/OFF (SHIFT+F5) key
WAIT ON	The actual test will start when the specified test wait time elapses.	

Table 4-5 Selectable range of LOWER/UPPER

MODE	Selectable range
DC, RMS	30 μ A to 30.0 mA
PEAK	50 μ A to 90.0 mA

Blinking indication UP <= LOW

If the lower reference is set to a value greater than or equal to the upper reference in the LOWER ON condition, "UP <= LOW" will blink at the upper right of the screen to indicate that the setting is invalid.

Setup Items of PCC2/2 (MODE / RANGE)

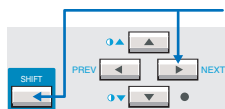

Press the NEXT (SHIFT+▶) key to display the PCC2/2 screen.

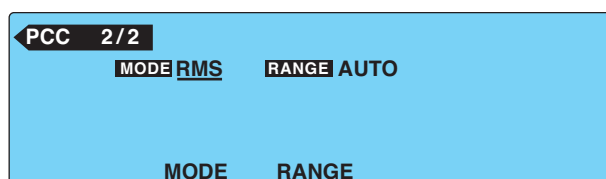

Item	Description	Panel operation
MODE	Selects the current measurement mode.	MODE (F2) key
	RMS RMS measurement	
	DC DC measurement	MODE (SHIFT+F2) key
	PEAK Peak measurement	
RANGE	Selects the measurement range.	RANGE (F3) key
	AUTO Automatically switches the range according to the measured value	
	FIX Fixes the range. The measurement range is determined by the upper reference and current measurement mode (MODE) settings. See Table 4-6.	RANGE (SHIFT+F3) key

Table 4-6 Determination of the measurement range

Measurement range	MODE	Upper reference
Range 1	DC, RMS	30 μ A to 600 μ A
	PEAK	50 μ A to 850 μ A
Range 2	DC, RMS	601 μ A to 6.00 mA
	PEAK	851 μ A to 8.50 mA
Range 3	DC, RMS	6.01 mA to 30.0 mA
	PEAK	8.51 mA to 90.0 mA

Setting Additional Test Conditions



You can set the following functions in the system setup screen (SYSTEM1/5) in addition to the test conditions of the TC or PCC measurement.

- Maximum value hold function of the measured current (MEAS MODE)
- Hold time of the PASS judgment (PASS HOLD)
- Measured current conversion display (CONV)
- Buzzer volume (BUZ VOL)

SYSTEM1/5				
MEAS MODE	: NORM	BUZ VOL (PASS)	:	3
PASS HOLD	: 2.0s	BUZ VOL (FAIL)	:	3
CONV	: OFF	CONTRAST	:	5
SELV	: OFF	LINE BRK(AUTO)	:	ON
MEAS	PASS	CONV	SELV	<NEXT>

Maximum Value Hold Function of the Measured Current (MEAS MODE)

This function holds and displays the maximum value measured during the test period. The maximum value is held for a single test. The held value is cleared when the test is completed.

See p. 51

The maximum measured value is not held during the test wait time.

- 1** Select the MEAS MODE on SYSTEM1/5.
- 2** Use the rotary knob to select the NORM or MAX.

NORM	Normal measurement (not hold the maximum value)
MAX	Hold the maximum value.

Hold Time of the PASS Judgment (PASS HOLD)

The test result data can be stored to the memory when the judgment result is displayed. If the judgment result is FAIL, the screen will show the FAIL result until you press the STOP switch. Therefore, you can store the data during this period.

See p. 200

On the contrary, the display time of a PASS judgment result is 2.0 s (default value). Thus, you must store the test result data during this period. If you want to make sure to store the data for PASS judgments, set the display time of the PASS judgment result (PASS HOLD) to HOLD.

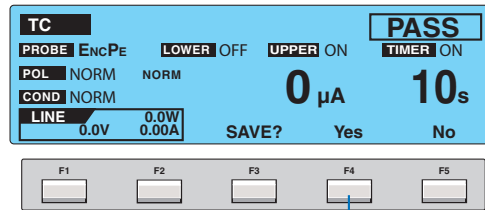

You cannot press the Yes (F4) key if the pass hold time is short.

- 1** Select the **PASS HOLD** on **SYSTEM1/5**.
- 2** Use the rotary knob to select the **PASS HOLD** time.

Time	Selectable range: 0.2 s to 10.0 s
HOLD	Hold until the STOP switch is pressed.

Measured Current Conversion Display (CONV)

The TOS3200 has the CONV function that converts the measured current using the ratio between the measured value of the line voltage applied to the AC inlet for the EUT and the preset CONV voltage.

For example, if the line voltage is 100.0 V and you set the preset CONV voltage to 106.0 V, the TOS3200 will display the value equal to 106% of the measured current.

- 1** Select the **CONV** on **SYSTEM1/5**.
- 2** Use the rotary knob to set the voltage.

Voltage	Selectable range: 80.0 V to 300.0 V
OFF	Disable the conversion display.

Buzzer Volume (BUZ VOL)

You can set the buzzer volume for PASS or FAIL judgments.

- 1** Select the **BUZ VOL** on **SYSTEM1/5**.
Select the BUZ VOL (PASS) to set the buzzer volume for PASS judgments, or select the BUZ VOL (FAIL) to set the buzzer volume for FAIL judgments.
- 2** Use the rotary knob to set the buzzer volume (**0 to 10**).
You can hear the buzzer volume by pressing the BUZ CHK (SHIFT+F5) key when BUZ VOL (PASS) or BUZ VOL (FAIL) is selected.

Starting the Test



Electric shock may occur. Do not touch the tip of the lead while using the test lead.

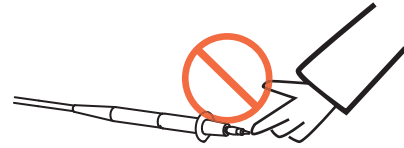

Starting the Test

- 1 Check that the TOS3200 is connected correctly to the EUT.
- 2 On TC1/2 or PCC1/2 with “READY” displayed, press the START switch.

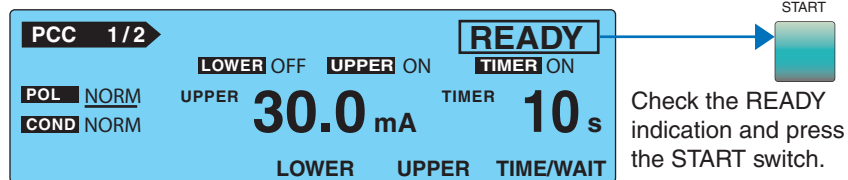

See p. 65

If you cannot start the test, see “Unable to Start the Test”.

When the Test Starts

The DANGER lamp illuminates. (When the status is WAIT or TEST)

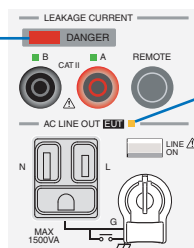

The power line to the EUT is turned on, and this LED illuminates.

If WAIT is set to ON

See p. 51

The status changes to WAIT, and the test wait time starts counting down. When the test wait time reaches 0 s, the status changes to TEST, and the actual test starts.

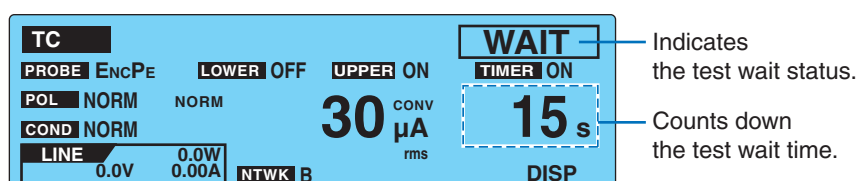

If WAIT is set to OFF

The status changes to TEST, and the actual test starts.

Indicates whether the measured current is shown using the normal display (NORM) or maximum value display (MAX).

- SYSTEM1/5 > MEAS MODE

Indicates that the measured current is indicated after a conversion.

- SYSTEM1/5 > CONV

Indicates the test-in-progress status.

The time indication after starting the test varies depending on whether the timer is on or off.

TIMER ON	Displays the remaining time of the timer.
TIMER OFF	Displays the elapsed time of the test. If 999 s is exceeded, "999" will blink.

Displays the voltage, current, and power of the power line applied to the AC inlet for the EUT.

Current measurement mode (RMS/DC/PEAK)

Measured current

The measured value is blinking

See p. 55, p. 59

If the measured value exceeds the measurement range specified by AUTO or FIX, the measured value will blink. For the PCC measurement, see Table 4-6 on page 59. For the TC measurement, see Table 4-4 on page 55.

↕ FAIL (CONTACT FAIL) is displayed

See p. 53

An error has been detected in the earthing check. For details, see "Earthing check".

CONV is displayed

If the current conversion display function is enabled and the power is not applied to the AC inlet for the EUT, "CONV" will be displayed. The conversion display function is invalid in this condition.

See p. 200

If you are supplying the EUT power from an external source (not from the TOS3200) in the TC measurement between two enclosures, turn the current conversion display function off.

- SYSTEM1/5>CONV

Switching to Expanded Display

Press the DISP (F5) key while the test is in progress to switch the measured value display as follows:

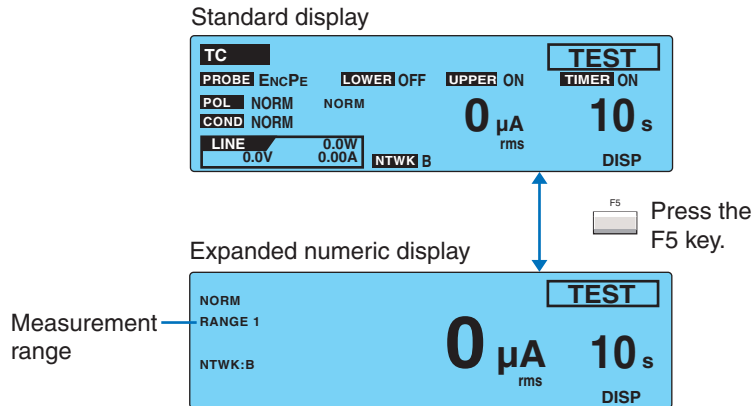

Displaying the Voltage between the Measurement Network Reference Points

See p. 176

Press the V DISP (SHIFT+F5) key in expanded numeric display mode to display the measured voltage between the measurement network reference points.

This function is only valid for touch current testing.

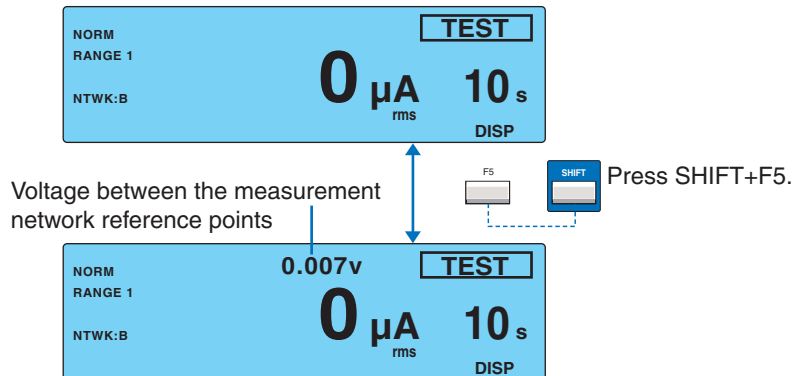

Unable to Start the Test

READY is not displayed

You will not be able to start the test in the following conditions.

- When TC2/2 or PCC2/2 is displayed.
- While recalling the panel memory or when the memory number has not been confirmed while storing to the memory.
- When the STOP switch is pressed (includes the condition in which the STOP signal is being applied to the SIGNAL I/O connector).
- When the power line of the EUT is turned on.

See p. 68

See p. 96

See p. 44

PASS or FAIL is displayed

You cannot start test while the judgment result is displayed. Press the STOP switch to set the TOS3200 to READY status.

PROTECTION is blinking

If "PROTECTION" is blinking on the screen, the TOS3200 is in the protection status. You cannot start the test in this status. Eliminate the cause of the protection status, and then start the test. For details, see "Protection Function".

See p. 204

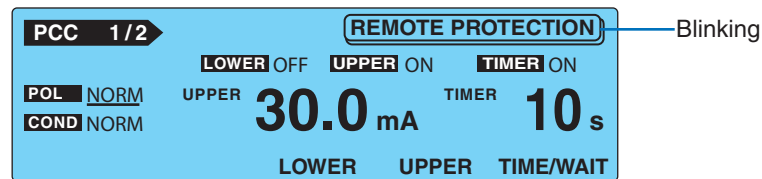

Stopping the Test

Aborting the Test

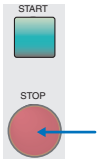

Press the STOP switch.

When the Test Ends

The test will stop in any of the conditions below.

- When the test time has elapsed (when TIMER is ON).
- When a current greater than or equal to the upper reference is measured (U-FAIL).
- When you press the STOP switch.

When the test stops, the DANGER lamp will turn off, and the power line to the EUT will be turned off.

If the test stops in the case of condition a or b above, the judgment result will be displayed on the screen.

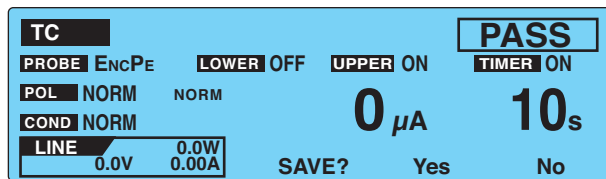

See p. 50

For details on how the TOS3200 judges the measured values, see “Judgment System”. Table 4-7 shows the TOS3200 operation when the test ends for each judgement result.

Table 4-7 Operation when the test ends

Operation	PASS	L-FAIL	U-FAIL
Display	Displays “PASS” on the screen.	Displays “↓FAIL” on the screen.	Displays “↑FAIL” on the screen.
Buzzer:	Sounds for 0.2 s.*1	Sounds until FAIL is cleared.	
SIGNAL I/O connector	Outputs the pass signal for the time specified by PASS HOLD.	Outputs the L-FAIL signal until FAIL is cleared.	Outputs the U-FAIL signal until FAIL is cleared.

*1 The duration of the buzzer for a PASS judgment is fixed to 0.2 s. It does not depend on the PASS HOLD time.

Storing the Test Result

See p. 67

The storage function is assigned to a function key while the judgment result is displayed. For details, see “Storing the Test Results”.

Releasing the Judgment Result

Press the STOP switch to set the TOS3200 to READY status.

Storing the Test Results

You can store up to 50 test results. The storage function is assigned to a function key while the judgment result (PASS or FAIL) is displayed.

- 1 Press the Yes (F4) key on the judgment result screen to display the MANUAL TEST DATA screen.

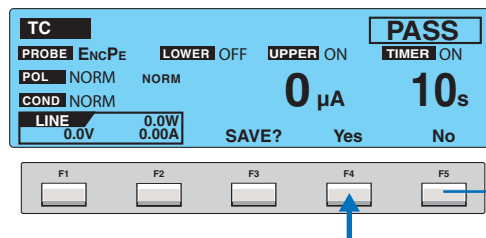

Does not save the test results. Skips to step 5.

- 2 Press the arrow keys (\blacktriangle \blacktriangledown \blacktriangleleft \blacktriangleright) to select the desired memory number.

If you select a memory number in which a test result is already saved, the saved information is displayed.

For tests executed using test conditions that were recalled from the panel memory, the panel memory number and name are included in the saved information.

Panel memory number: memory name year/month/day hour:minute

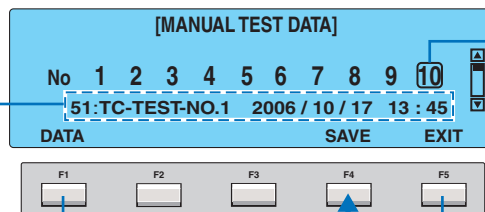

Move the box using the arrow keys to select the number.

Displays the test data of the selected memory number.

Aborts the save operation.

You can check the existing data before overwriting the existing data.

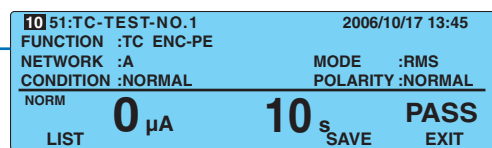

Return to the memory selection screen.

- 3 Press the SAVE (F4) key. The stored information is displayed. Press the DATA (F1) key to check the stored data.

- 4 Press the EXIT (F5) key. The data store screen closes, and the TOS3200 changes to the READY status.

Displaying the Test Results

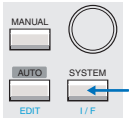

You can display the stored test results from the system setup screen 3/5 (SYSTEM3/5).

- 1 Press the **SYSTEM** key to display **SYSTEM1/5**.
- 2 Press the **<NEXT>** (F5) key twice to display **SYSTEM3/5**.

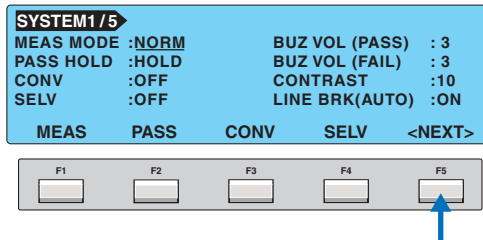

- 3 Press the arrow keys (**▲ ▼ ◀ ▶**) to select the desired memory number.

If you select a memory number in which a test result is already saved, the saved information is displayed.

For tests executed using test conditions that were recalled from the panel memory, the panel memory number and name are included in the saved information.

Panel memory number: memory name year/month/day hour:minute

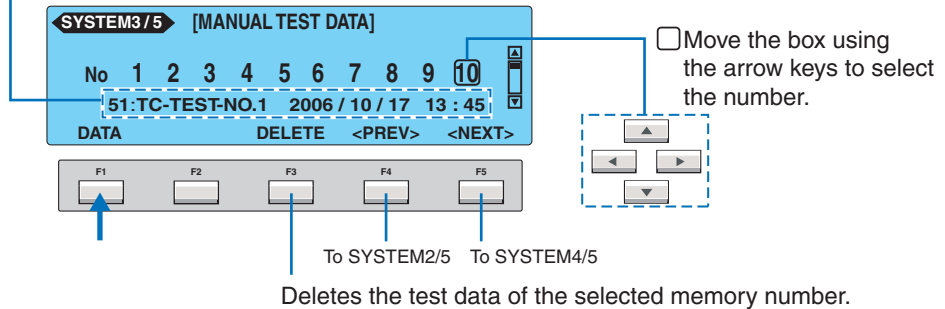

Deletes the test data of the selected memory number.

- 4 Press the **DATA** (F1) key.
The stored test results are displayed.

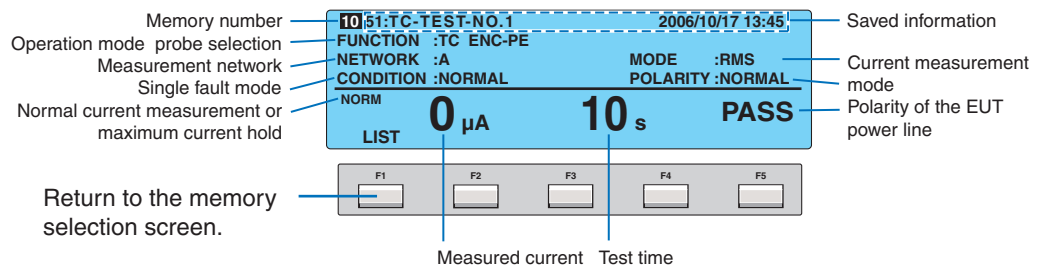

To return to the current measurement, press the **MANUAL** key.

Deleting the Stored Data

Select the memory number you want to delete in step 3 above, and press the **DELETE** (F3) key.



Meter Mode Measurement

This chapter explains the touch current measurement in Meter Mode.

Connecting the EUT

Constructing the Connection Circuit

In meter mode measurement, an external circuit is constructed as shown in Fig. 5-1, and the current flowing between terminals A and B is measured. Fig. 5-1 illustrates the TC measurement between the enclosure and earth.

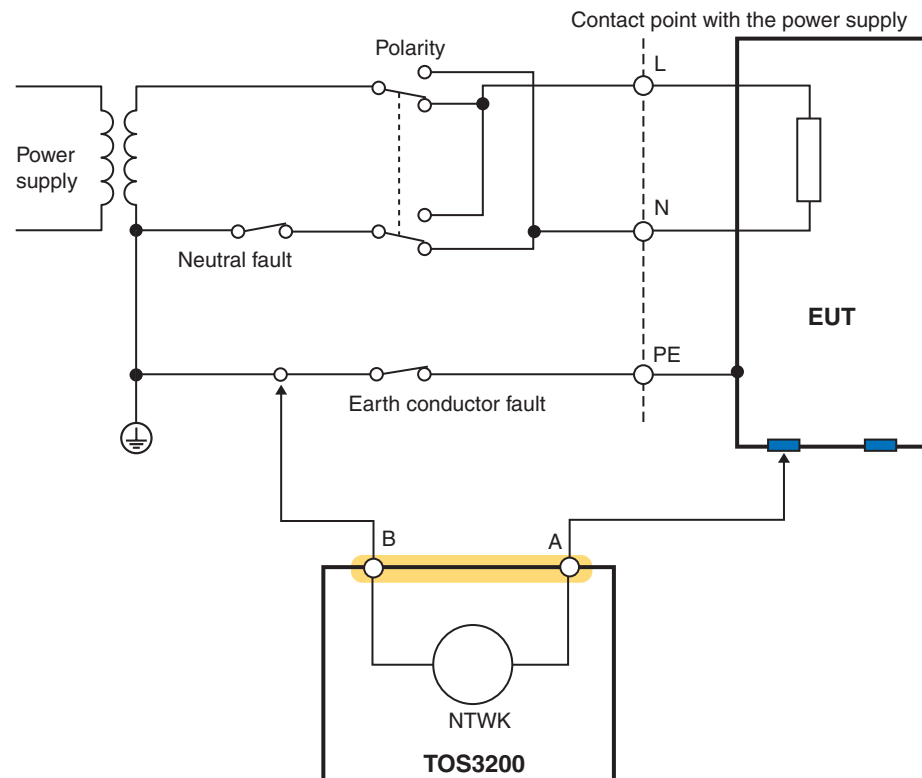

Fig. 5-1 Connection example in Meter Mode

Connecting the Test lead (TL21-TOS)

The test lead is used in the TC measurement.



Electric shock may occur. Do not touch the tip of the lead while using the test lead.

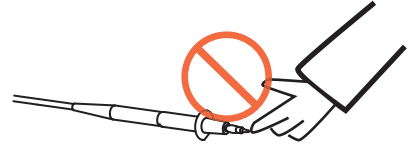

The red or black test lead is used separately according to the type of TC to be measured. The red and black test leads are connected to measurement terminals A and B, respectively.

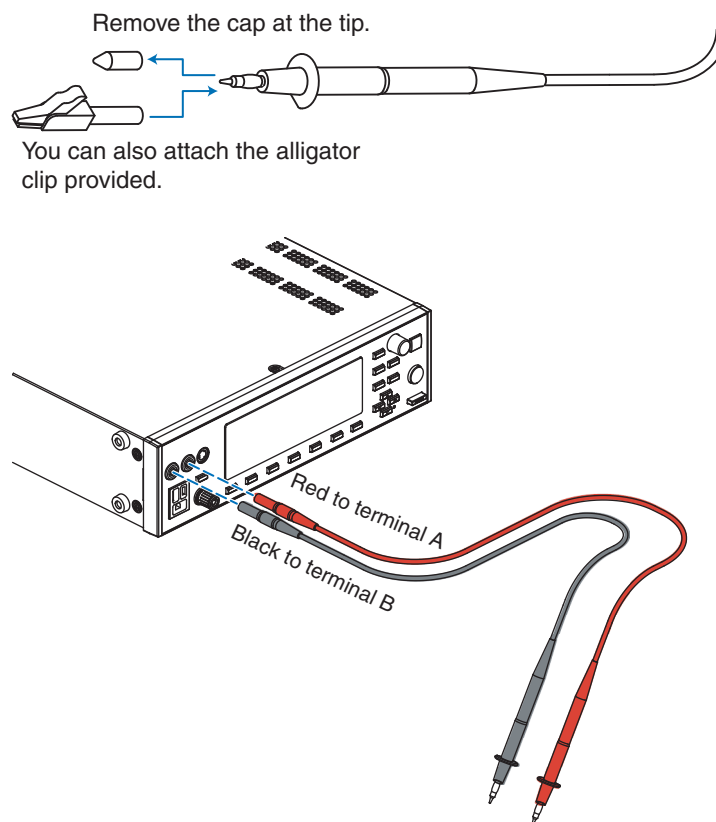

Fig. 5-2 Test lead usage

Measuring in Meter Mode

In Meter Mode, the TOS3200 measures and displays the current flowing through measurement terminals A and B or the voltage between A and B as with a general multimeter. The TOS3200 does not judge the results against the reference.

Press the MANUAL key to display the meter mode measurement screen 1/2 (METER1/2).

The meter mode measurement screen consists of two screens (METER1/2 and 2/2). There are no items that you set on METER1/2. The displayed value is the present measured value.

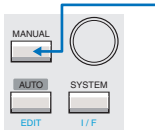

See p. 70

For the procedure to connect the EUT, see “Connecting the EUT”.

Indicates the selected measurement network. Displayed when the current is displayed.

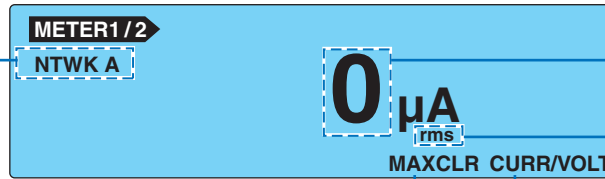

Current or voltage between measurement terminals A and B

Current measurement mode (RMS/DC/PEAK)

Clears the maximum measured value that is held. Displayed when MEAS MODE is set to MAX in SYSTEM1/5.

Switches between current measurement and voltage measurement.

Displaying the voltage between the measurement network reference points

See p. 176

Press the V DISP (SHIFT+F5) key while the measured current is displayed to display the voltage between the measurement network reference points.

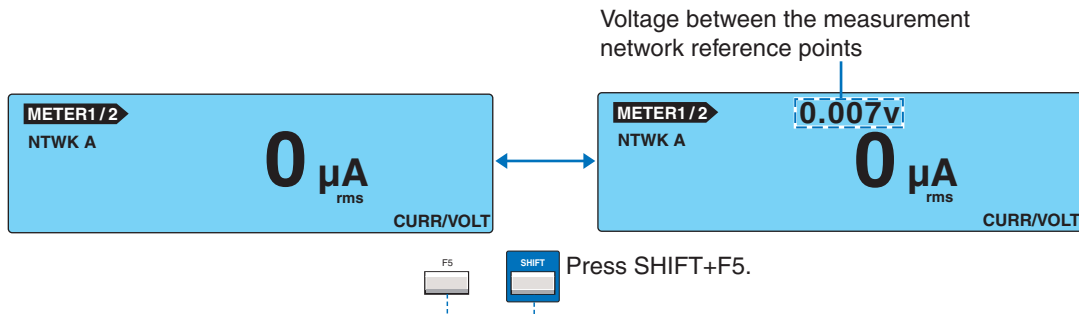

Maximum Value Hold Function of the Measured Current (MEAS MODE)

This function holds and displays the maximum value measured.

The held maximum value is cleared when you press the MAXCLR (F4) key.

- 1** Select the MEAS MODE on SYSTEM1/5.
- 2** Use the rotary knob to select the NORM or MAX.

NORM	Normal measurement (not hold the maximum value)
MAX	Hold the maximum value.

SELV Detection Function

If the voltage between measurement terminals A and B exceeds the preset safety extra low voltage (SELV), the DANGER lamp will illuminate.

The SELV detection is carried out while the voltage is displayed.

- 1 Select the SELV on SYSTEM1/5.
- 2 Use the rotary knob to set the SELV.

SELV	10 V to 99 V
MAX	Disable the SELV check function.

Setup Items of METER2/2 (NTWK / MODE / RANGE)

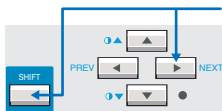

Press the NEXT (SHIFT+▶) key to display the METER2/2 screen.

See p. 31

For the procedure to select items and enter data, see "Panel Control Basics".

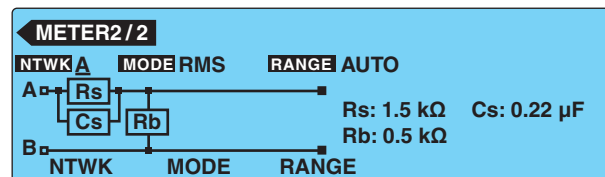

Item	Description	Panel operation
NTWK *1	Selects the measurement network.	NTWK (F1) key
A	(For IEC 60990) $(1.5 \text{ k}\Omega // 0.22 \text{ }\mu\text{F}) + 500 \text{ }\Omega$	
B	(For IEC 60990) $(1.5 \text{ k}\Omega // 0.22 \text{ }\mu\text{F}) + 500 \text{ }\Omega // (10 \text{ k}\Omega + 22 \text{ nF})$	
B1*1	(For IEC 60065) $(1.5 \text{ k}\Omega // 0.22 \text{ }\mu\text{F}) + 500 \text{ }\Omega // (10 \text{ k}\Omega + 22 \text{ nF})$	
C	(For IEC 60990) $(1.5 \text{ k}\Omega // 0.22 \text{ }\mu\text{F}) + 500 \text{ }\Omega // (10 \text{ k}\Omega + (20 \text{ k}\Omega + 6.2 \text{ nF}) // 9.1 \text{ nF})$	NTWK (SHIFT+F1) key
D	1 kΩ	
E	$1 \text{ k}\Omega // (10 \text{ k}\Omega + 11.225 \text{ nF} + 579 \text{ }\Omega)$	
F	$1.5 \text{ k}\Omega // 0.15 \text{ }\mu\text{F}$	
G	2 kΩ	

*1 This item cannot be selected if voltage display is specified on METER1/2.

*2 Measures voltage U1 between the measurement network reference points.

See p. 176

NTWK, MODE, and RANGE Settings on METER2/2 (Cont'd)

Item	Description	Panel operation
MODE	Selects the electric current measurement mode.	MODE (F2) key
	RMS RMS measurement	MODE (SHIFT+F2) key
	DC DC measurement	MODE (SHIFT+F2) key
	PEAK Peak measurement	
RANGE ^{*2}	Selects the measurement range.	RANGE (F3) key
	AUTO Automatically switches the range based on the measured value.	
	RANGE1 The measurement range is determined by the measurement network (NTWK) and current measurement mode (MODE) settings. See Table 5-1 for details.	RANGE (SHIFT+F3) key
	RANGE2	
	RANGE3	

*3 You cannot select this item if voltage display is specified on METER1/2. The voltage measurement range is as shown in Table 5-2 and is set to AUTO range.

Table 5-1 Measurement range of fixed ranges

Measurement range setting	MODE	Measurement range			
		NTWK A, B, B1, C	NTWK D, E	NTWK F	NTWK G
Range 1	DC, RMS	30 μ A to 600 μ A	30 μ A to 300 μ A	30 μ A to 200 μ A	30 μ A to 150 μ A
	PEAK	50 μ A to 850 μ A	50 μ A to 424 μ A	50 μ A to 282 μ A	50 μ A to 212 μ A
Range 2	DC, RMS	500 μ A to 6.00 mA	250 μ A to 3.00 mA	166 μ A to 2.00 mA	125 μ A to 1.50 mA
	PEAK	700 μ A to 8.50 mA	350 μ A to 4.24 mA	233 μ A to 2.82 mA	175 μ A to 2.12 mA
Range 3	DC, RMS	5.00 mA to 30.0 mA	2.50 mA to 30.0 mA	1.66 mA to 20.0 mA	1.25 mA to 15.0 mA
	PEAK	7.00 mA to 90.0 mA	3.50 mA to 45.0 mA	2.33 mA to 30.0 mA	1.75 mA to 22.5 mA

Table 5-2 Voltage measurement range

MODE	Measurement range
DC	10.00 V to 300.0 V
RMS	10.00 V to 300.0 V
PEAK	15.00 V to 430.0 V

The measured value is blinking

If the measured value exceeds the measurement range specified by AUTO or a range setting, the measured value blinks.



Program Test

This chapter describes how to create and edit sequence programs and how to execute the test.

Program Tests

A sequence program allows various tests to be executed consecutively by changing the test conditions of the PCC or TC and the test lead connections.

For example, the following five tests can be executed consecutively by simply changing the test lead connections between each test (interval), and the result can be stored.

- 00 PCC measurement
- 01 TC measurement between the enclosure and earth
- 02 TC measurement between two enclosures
- 03 TC measurement between the enclosure and power line (live)
- 04 TC measurement between the enclosure and power line (neutral)

Up to 100 sequence programs can be created. You can assign a name to each program using a number between 00 and 99 and up to 12 characters.

Each sequence program can consist up to 100 single tests (100 steps). However, the total number of steps of all programs is 500. For example, up to five sequence programs consisting of 100 steps each can be created.

Press the AUTO key to display the program test screen 1/2 (AUTO1/2).

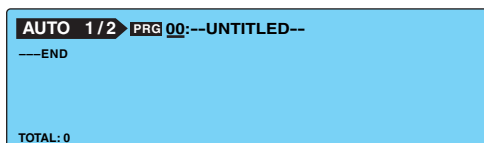
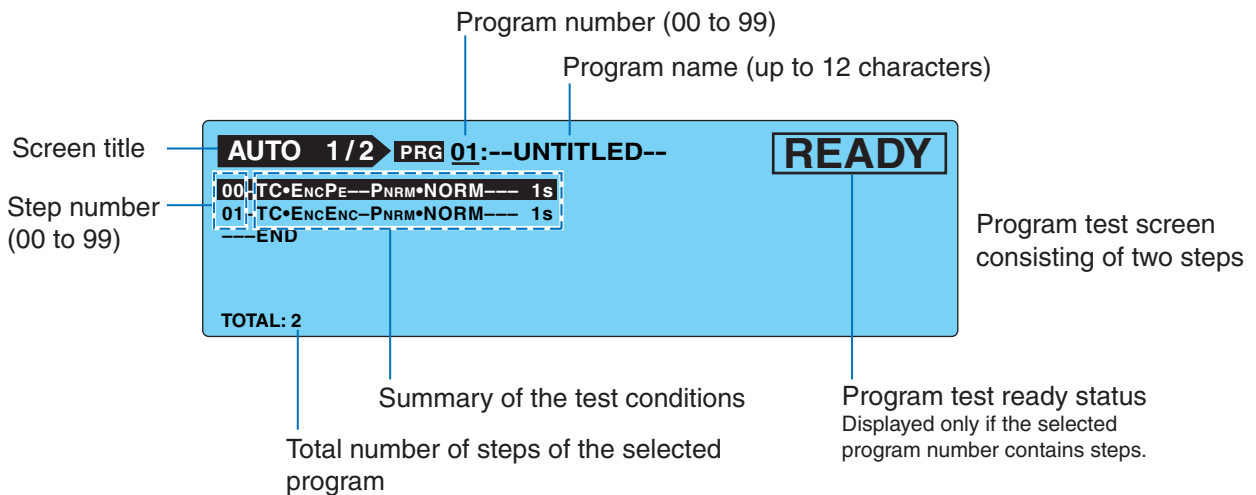

The screen when a program in which no steps are configured is selected

Limitations on the Test Conditions in the Steps

You can set test conditions for each step of a program test in the same way as a single test. However, the following limitations exist.

- The measurement network (NTWK), current measurement mode (MODE), and measurement range (RANGE) settings are common to all steps. You cannot select different settings for each step.
- Panel memories cannot be recalled.
- The measured values cannot be displayed expanded while the test is in progress.

Interval Time

You can set a pause time (interval) at the end of each step. If the TOS3200 shuts off the EUT power line during this interval, you can change the test lead connections.

For example, if the interval of step 01 is set to HOLD as shown in the example of Fig. 6-1, the test will not proceed to step 02 until you press the START switch after the end of the step 01 test. This allows you to change the test lead connection for sure.

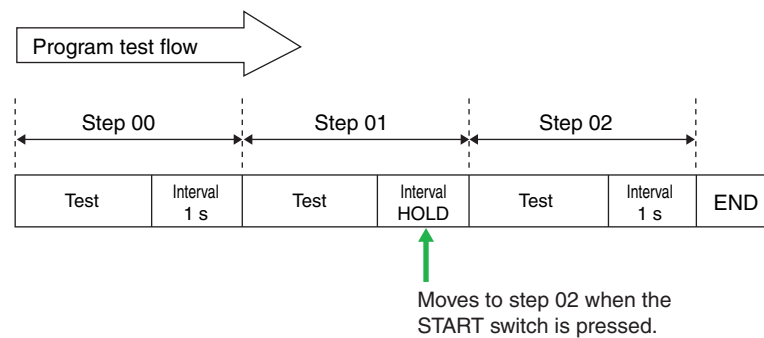

Fig. 6-1 Interval setting example

Power Supply to the EUT

You can select whether to supply power (OFF) or not supply power (ON) to the EUT during the interval time.

- SYSTEM1/5 > LINE BRK (AUTO)

NOTE

Even if you set LINE BRK (AUTO) to OFF, when the EUT power supply switches from a positive phase connection to a negative phase connection between steps, the TOS3200 does not supply power to the EUT. The only way that you can switch the connection is by shutting off the power supply

Creating Sequence Programs

To create a sequence program, enter the edit screen from the program test screen.

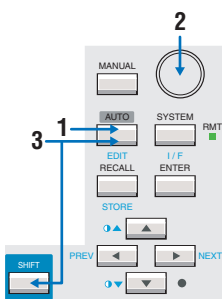

- 1 Press the AUTO key.**
The program test screen 1/2 (AUTO1/2) appears.
- 2 Use the rotary knob to select a new program or the program you want to edit.**
- 3 Press the EDIT (SHIFT+AUTO) key.**
“EDIT” appears on the screen, and the edit screen is displayed.

Inserting a Step in a New Program

The end of the step sequence is selected.



F1 Press the F1 key.

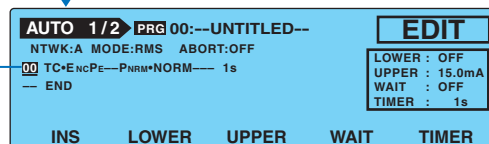

A step with a default value is inserted above END.

Default values of the step that is inserted

Item	Default value	items common to the step	Default value
Operation mode	TC	Measurement network (NTWK)	A
Connection destination of the measurement terminal (PROBE)	ENCPE	Current measurement mode (MODE)	RMS
Polarity of the EUT power line (POL)	NORM	Measurement range (RANGE)	AUTO
Single fault mode (COND)	NORM	Operation for FAIL judgment (ABORT)	OFF
Interval time	1 s		
Upper reference (UPPER)	15 mA		
Lower reference (LOWER)	OFF (30 μ A)		
Test time (TIMER)	ON (1 s)		
Test wait time (WAIT)	OFF (1 s)		

Inserting a Step in an Existing Program

Select the position where you want to insert a step.
(The new step is inserted above the selected step.)

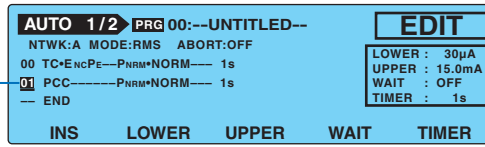

 Press the F1 key.

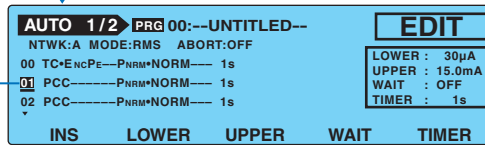



A copy of step 01 is inserted.
(The selected step number does not change, but step 02 was step 01 before the INS key was pressed.)

Deleting a Step

Select the step you want to delete.



  Press the SHIFT+F1 key.

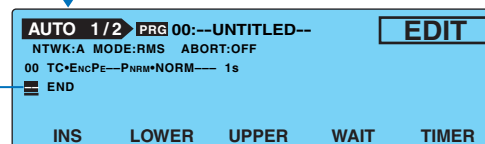

The selected pattern is deleted.

Setup Items of AUTO1/2

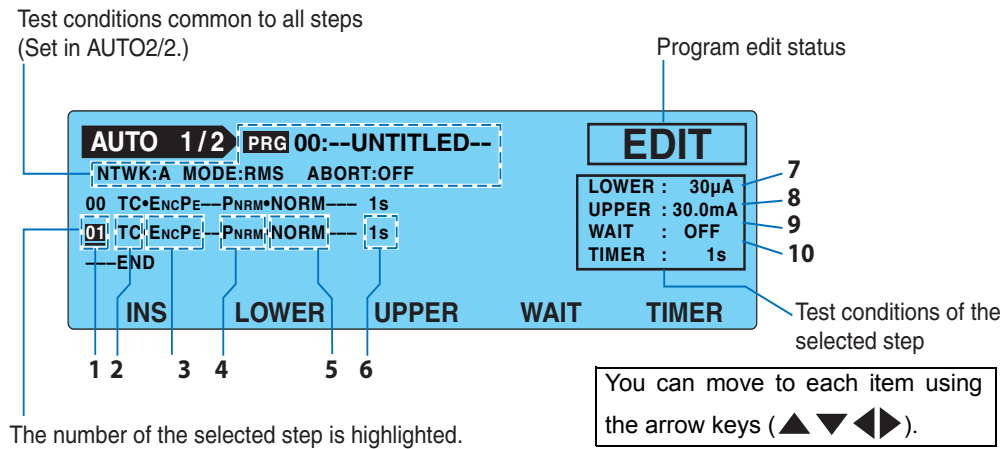

Item	Description	Panel operation
1 (Step number)	Selects the step number to be edited.	Rotary knob
2 (Operation mode)	Selects TC or PCCTC.	Rotary knob
3 (PROBE) ^{*1}	Selects the connection destination of measurement terminals A and B. ENcPE Connected between the enclosure and earth. ENcENC Connected between two enclosures. ENcLIV Connected between the enclosure and power line (live). ENcNEU Connected between the enclosure and power line (neutral).	Rotary knob
4 (POL) ^{*2}	Selects the polarity of the power line supplied to the EUT. PNRM Normal phase connection PRVS Reverse phase connection	Rotary knob
5 COND ^{*2}	Selects the single fault mode. NORM Normal status FLTNEU Power line (neutral) disconnected status FLTPE Earth line disconnected status	Rotary knob
6 (Interval)	Sets the time until the next step is executed in the range of 1 s to 99 s or HOLD. If set to HOLD, the next step will not start until you press the START switch.	Rotary knob
7 LOWER	Sets the lower limit of the judgment reference. Lower reference The selectable range varies depending on the NTWK (measurement network) and MODE (current measurement mode) settings on AUTO2/2. See Table 6-1. You will not be able to enter the value if set to OFF. ON/OFF The item is turned on when the value is displayed.	F2 key Rotary knob SHIFT+F2 key
8 UPPER	Sets the upper limit of the judgment reference. Upper reference The selectable range varies depending on the NTWK (measurement network) and MODE (current measurement mode) settings on AUTO2/2. See Table 6-1. You will not be able to enter the value if set to OFF. ON/OFF The item is turned on when the value is displayed.	F3 key Rotary knob SHIFT+F3 key

Item	Description	Panel operation
9 WAIT	Sets the test wait time.	
	Test wait time	Set the test wait time in the range of 1 s to 999 s. You will not be able to enter the value if set to OFF.
	ON/OFF	The item is turned on when the value is displayed.
10 TIMER	Sets the test time.	
	Test time	Set the test time in the range of 1 s to 999 s. You will not be able to enter the value if set to OFF.
	ON/OFF	The item is turned on when the value is displayed.

- *1. You will not be able to select this item if you select PCC for item 2 (operation mode).
- *2. You will not be able select this item if ENCLIV or ENCNEU is selected for item 3 (PROBE). Item 4 (POL) and 5 (COND) are set to PNRM and NORM, respectively, regardless of the present setting.

Table 6-1 Selectable range of LOWER/UPPER

MODE	PCC	NTWK A, B,B1, C	NTWK D, E	NTWK F	NTWK G
DC, RMS		30 μA to 30.0 mA	30 μA to 30.0 mA	30 μA to 20.0 mA	30 μA to 15.0 mA
PEAK		50 μA to 90.0 mA	50 μA to 45.0 mA	50 μA to 30.0 mA	50 μA to 22.5 mA

Earthing check

If the PROBE item is set to ENCLIV or ENCNEU, measurement terminal A is connected to the EUT enclosure (floating section) and terminal B of the measurement network (NTWK) is connected to the power line (L or N) inside the TOS3200 to execute the test. Therefore, if the EUT enclosure is grounded, a dangerous earth fault will result through the NTWK. It is also possible that measurement terminal A be connected to the grounded section of the enclosure by mistake. It is necessary to check that the measurement points is not grounded in advance to perform the test safely.

The earthing check automatically makes this check. When you press the START switch, the TOS3200 supplies a low current between measurement terminals A and earth before the actual test, measures this current, and checks the grounding of the measurement point. If the measurement point is grounded, “↓FAIL” (CONTACT FAIL) will be indicated on the screen, and the test will be aborted.

Both the U-FAIL and L-FAIL signals are delivered from the SIGNAL I/O connector. To clear CONTACT FAIL, press the STOP switch.

 p. 96

CAUTION

If you connect the test lead to the measurement point after you press the START switch, the TOS3200 will judge that the measurement point is not grounded, and the earthing check will pass. If you do this, you will not be able to check mistakes in the connection. Be sure to connect the test lead to the measurement point first, and then press the START switch.

NOTE

If you set LINE BRK (AUTO) to OFF and PROBE to EncLiv or EncNeu, the TOS3200 does not perform earthing checks. See p. 88 for details.

Blinking UP <= LOW indication

If the lower reference is set to a value greater than or equal to the upper reference in the LOWER ON condition, “UP <= LOW” will appear at the upper right of the screen to indicate that the setting is invalid.

Setup Items of AUTO2/2 (Common to All Steps)

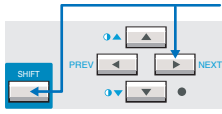

Press the NEXT (SHIFT+▶) key to display the program edit screen 2/2 (AUTO2/2).
On AUTO2/2, set the items common to all steps.

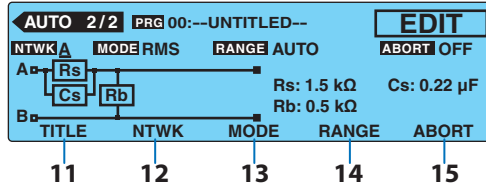

Item	Description	Panel operation
11 TITLE	Selects the program name.	F1 key
	Name Up to 12 of the characters shown in Table 3-1 on page 39 can be entered.	Rotary knob
12 NTWK	Selects the measurement network.	F2 key
	A (For IEC 60990) (1.5 kΩ // 0.22 μF) + 500 Ω	
	B (For IEC 60990) (1.5 kΩ // 0.22 μF) + 500 Ω // (10 kΩ + 22 nF)	
	B1*1 (For IEC 60065) (1.5 kΩ // 0.22 μF) + 500 Ω // (10 kΩ + 22 nF)	
	C (For IEC 60990) (1.5 kΩ // 0.22 μF) + 500 Ω // (10 kΩ + (20 kΩ + 6.2 nF) // 9.1 nF)	SHIFT+F2 key
	D 1 kΩ	
	E 1 kΩ // (10 kΩ + 11.225 nF + 579 Ω)	
	F 1.5 kΩ // 0.15 μF	
G 2 kΩ		
13 MODE	Selects the current measurement mode.	F3 key
	RMS RMS measurement	
	DC DC measurement	SHIFT+F3 key
	PEAK Peak measurement	
14 RANGE	Selects the measurement range.	F4 key
	AUTO Automatically switches the range according to the measured value.	
	FIX Fixes the range. The measurement range is determined by the upper reference, measurement network (NTWK), and current measurement mode (MODE) settings. See Table 6-2.	SHIFT+F4 key
15 ABORT	Selects the operation if a FAIL judgment occurs while a program test is in progress.	F5 key
	OFF Executes the next step even if a FAIL judgment occurs.	
	ON Aborts the program test when a FAIL judgment occurs.	SHIFT+F5 key

See p. 176

*1 Measures voltage U1 between the measurement network reference points.

Table 6-2 Determination of the fixed range

Measurement range	MODE	Upper reference			
		PCC	NTWK A, B, B1, C	NTWK D, E	NTWK F
Range 1	DC, RMS	30 μA to 600 μA	30 μA to 300 μA	30 μA to 200 μA	30 μA to 150 μA
	PEAK	50 μA to 850 μA	50 μA to 424 μA	50 μA to 282 μA	50 μA to 212 μA
Range 2	DC, RMS	601 μA to 6.00 mA	301 μA to 3.00 mA	201 μA to 2.00 mA	151 μA to 1.50 mA
	PEAK	851 μA to 8.50 mA	425 μA to 4.24 mA	283 μA to 2.82 mA	213 μA to 2.12 mA
Range 3	DC, RMS	6.01 mA to 30.0 mA	3.01 mA to 30.0 mA	2.01 mA to 20.0 mA	1.51 mA to 15.0 mA
	PEAK	8.51 mA to 90.0 mA	4.25 mA to 45.0 mA	2.83 mA to 30.0 mA	2.13 mA to 22.5 mA

Sequence Program Editing Procedure

This section describes the setup procedure of test conditions using an example in which the TC measurement (between the enclosure and earth) is performed and then the PCC measurement is performed by removing the test lead from the EUT. The detailed settings of this test are shown below.

Items common to all steps	Setting
Program number	01
Program name	TEST-1
Measurement network (NTWK)	B
Current measurement mode (MODE)	RMS
Measurement range (RANGE)	AUTO
Operation for FAIL judgment (ABORT)	Continue (OFF)

Steps specific to each step	Setting	
Step number	00	01
Operation mode	TC measurement	PCC measurement (PCC)
Connection destination of the measurement terminal (PROBE)	ENCPE	—
Polarity of the EUT power line (POL)	Normal phase connection (PNRM)	Normal phase connection (PNRM)
Single fault mode (COND)	Normal status (NORM)	Normal status (NORM)
Interval	Until the START switch is pressed (HOLD)	1 s
Upper reference (UPPER)	0.5 mA	1 mA
Lower reference (LOWER)	35 μ A	None (OFF)
Test wait time (WAIT)	None (OFF)	None (OFF)
Test time (TIMER)	1 s	1 s

The following procedure assumes that nothing is assigned to program number 01 at start.

Entering the Edit Screen

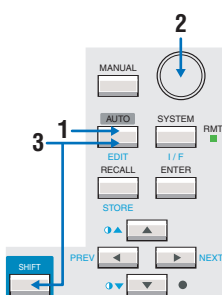

- 1** Press the AUTO key to display AUTO1/2.
- 2** Use the rotary knob to select program number 01.
- 3** Press the EDIT (SHIFT+AUTO) key to display the edit screen.

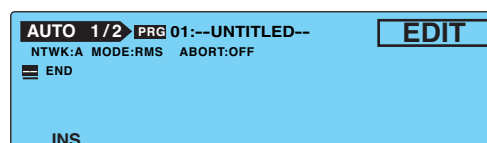

Setting Items Common to the Program (All Steps)

- 1** Press the NEXT (SHIFT+▶) key to display the AUTO2/2.
- 2** Press the TITLE (F1) key to select the program name.
- 3** Use the rotary knob to select “T,” and press the ▶ key to move the underscore to the right by an item.
- 4** Use the rotary knob to select “E.”
Repeat similar steps to enter “TEST-1.”
To delete a character, enter a space.
- 5** After you enter the program name, press the TITLE (F1) key.
- 6** Press the NTKW (SHIFT+F2) key to set NTKW to B.
Because default settings are used for MODE, RANGE, and ABORT, do not change these items.

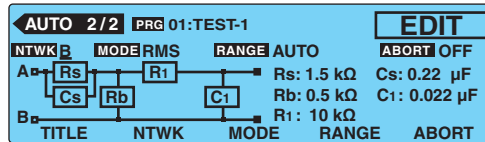

- 7** Press the PREV (SHIFT+◀) key to display the AUTO1/2.

Setting Step 00

- 1** Press the INS (F1) key to insert step 00.
Step number 00 is selected.
- 2** Press the ▶ key to move the underscore to the right by a character, and use the rotary knob to select TC.
- 3** Press the ▶ key to move the underscore to the right by four items to select the interval.
Because default settings are used for the connection destination of the measurement terminal (PROBE), polarity of the EUT power line (POL), and single fault mode (COND), these items are not changed.
- 4** Use the rotary knob to select HOLD.
By selecting HOLD, step 01 is not executed until you press the START switch again after step 00 is completed. After removing the test lead from the EUT, you can continue the test by pressing the START switch.

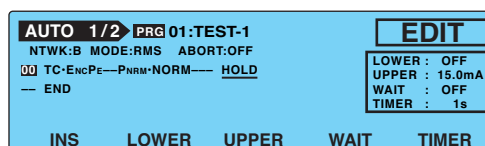

- 5** Press the LOWER ON/OFF (SHIFT+F2) key to set LOWER to ON.

By default, LOWER is set to OFF. If LOWER is set to OFF, you will not be able to enter the value even though you can select it using the F3 key or arrow keys.

- 6** Use the rotary knob to set 35 μ A.
- 7** Press the UPPER (F3) key to select UPPER.
- 8** Use the rotary knob to set 500 μ A.

Because default settings are used for WAIT and TIMER, these items are not changed.

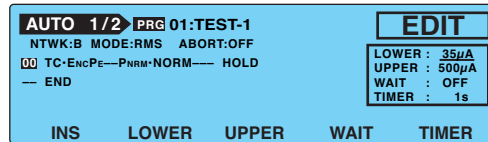

Setting Step 01

- 1** Press the arrow keys (\blacktriangle \blacktriangledown \blacktriangleleft \blacktriangleright) to select step number 00.
The new step is inserted above the selected step.
- 2** Press the INS (F1) key to insert a new step.
A copy of step 00 is inserted above step 00.
- 3** Because step number 00 is selected, press the \blacktriangledown key to select 01.
- 4** Press the \blacktriangleright key to move the underscore to the right by an item.
- 5** Use the rotary knob to select PCC.
If PCC is selected, the connection destination of the measurement terminal (PROBE) of the adjacent item will become "----."
- 6** Set each item by carrying out the procedure similar to step 00.

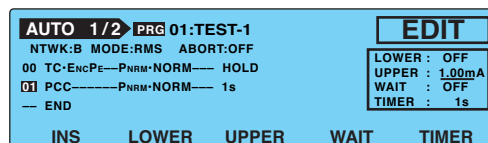

Exiting from the Edit Screen

After you are done entering the settings, press the AUTO key.

The setup screen closes, and the screen displays "READY."

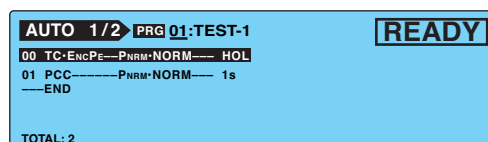

Setting Additional Test Conditions

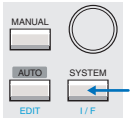

You can set the following functions in the system setup screen (SYSTEM1/5) in addition to the program test conditions.

- Maximum value hold function of the measured current (MEAS MODE)
- Hold time of the PASS judgment (PASS HOLD)
- Measured current conversion display (CONV)
- Buzzer volume (BUZ VOL)
- Power supply to the EUT during the interval time (LINE BRK (AUTO))

SYSTEM1/5				
MEAS MODE	: <u>NORM</u>	BUZ VOL (PASS)	:	3
PASS HOLD	: 2.0s	BUZ VOL (FAIL)	:	3
CONV	: OFF	CONTRAST	:	5
SELV	: OFF	LINE BRK(AUTO)	:	ON
MEAS	PASS	CONV	SELV	<NEXT>

Maximum Value Hold Function of the Measured Current (MEAS MODE)

This function holds and displays the maximum value measured during the test period.

The maximum value is held for a single test. The held value is cleared when the test is completed.

See p. 51

The maximum measured value is not held during the test wait time.

- 1** Select the MEAS MODE on SYSTEM1/5.
- 2** Use the rotary knob to select the NORM or MAX.

NORM	Normal measurement (not hold the maximum value)
MAX	Hold the maximum value.

Hold Time of the PASS Judgment (PASS HOLD)

See p. 93

The test result data can be saved to the memory when the total judgment is displayed after the program test is completed.

If the total judgment is FAIL, the screen will show the FAIL result until you press the STOP switch. Therefore, you can save the data during this period.

See p. 196

On the contrary, the display time when the total judgment is PASS is 2.0 s (default value). Thus, you must save the test result data during this period. If you want to make sure to save the data for PASS judgments, set the display time of the PASS judgment result (PASS HOLD) to HOLD.

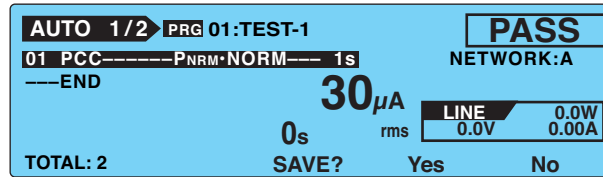

- 1** Select the **PASS HOLD** on **SYSTEM1/5**.
- 2** Use the rotary knob to select the **PASS HOLD** time.

Time	Selectable range: 0.2 s to 10.0 s
HOLD	Hold until the STOP switch is pressed.

NOTE

The PASS HOLD time setting of the program test is valid only when the program test is complete. The PASS judgment display for each step depends on the interval time setting.

Measured Current Conversion Display (CONV)

6

Program Test

The TOS3200 has a function called CONV that converts the measured current by the ratio between the preset CONV voltage and the measured value of the line voltage applied to the EUT AC inlet.

For example, if the line voltage is 100.0 V and you set the preset CONV voltage to 106.0 V, the TOS3200 displays values equal to 106% of the measured currents.

- 1** Select the **CONV** on **SYSTEM1/5**.
- 2** Use the rotary knob to set the voltage.

Voltage	Selectable range: 80.0 V to 300.0 V
OFF	Disable the conversion display.

Buzzer Volume (BUZ VOL)

You can set the buzzer volume for PASS or FAIL judgments.

- 1** Select the **BUZ VOL** on **SYSTEM1/5**.
Select the BUZ VOL (PASS) to set the buzzer volume for PASS judgments, or select the BUZ VOL (FAIL) to set the buzzer volume for FAIL judgments.
- 2** Use the rotary knob to set the buzzer volume (0 to 10).
You can hear the buzzer volume by pressing the BUZ CHK (SHIFT+F5) key when BUZ VOL (PASS) or BUZ VOL (FAIL) is selected.

Power supply to the EUT during the interval time (LINE BRK (AUTO))

See p. 77

Sets whether or not to supply power to the EUT during program test interval time.

On SYSTEM1/5, press the LINE BRK (AUTO; SHIFT+F4) to select ON or OFF.

ON	Does not supply power to the EUT during the interval time
OFF	Supplies power to the EUT during the interval time

NOTE

- Even if you set LINE BRK (AUTO) to OFF, when the EUT power supply switches from a positive phase connection to a negative phase connection between steps, the TOS3200 does not supply power to the EUT. The only way that you can switch the connection is by shutting off the power supply.
- If you set LINE BRK (AUTO) to OFF and PROBE to EncLiv or EncNeu, the TOS3200 does not perform earthing checks. See p. 81 for details.

Starting the Test



Electric shock may occur. Do not touch the tip of the lead while using the test lead.

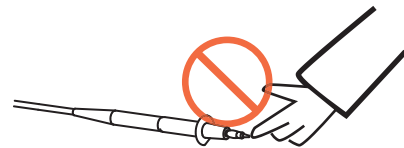

Starting the test

- 1 Check that the TOS3200 is connected correctly to the EUT.
- 2 On AUTO1/2 with “READY” displayed, press the START switch.

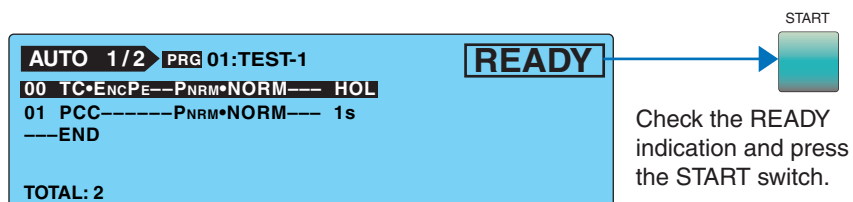

When a test starts

NOTE

If LINE BRK (AUTO) is set to ON, the DANGER lamp and the LINE ON LED do not illuminate during the interval time.

See p. 88

The DANGER lamp illuminates.

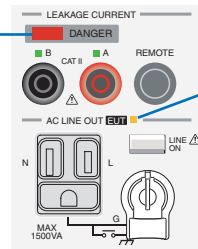

The power line to the EUT is turned on, and this LED illuminates.

In steps in which WAIT is set to ON

See p. 51

The status changes to WAIT, and the test wait time starts counting down. When the test wait time reaches 0 s, the status changes to TEST, and the test of that step actually starts.

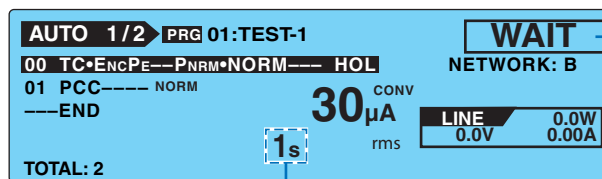

Indicates the test wait status.

Counts down the test wait time.

In steps in which WAIT is set to OFF

The status changes to TEST, and the test of that step actually starts.

The step that is being executed is highlighted.

Indicates that the measured current is indicated after a conversion.
· SYSTEM1/5 > CONV

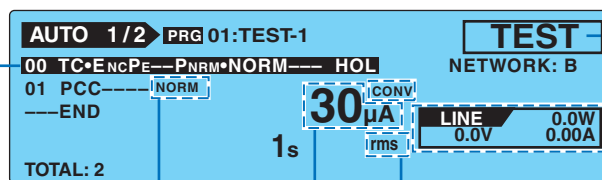

Indicates the test-in-progress status.

Displays the voltage, current, and power of the power line applied to the AC inlet for the EUT.

Measured current
Current measurement mode (RMS/DC/PEAK)

Indicates whether the measured current is shown using the normal display (NORM) or maximum value display (MAX).

· SYSTEM1/5 > MEAS MODE

During the interval

The judgment result of the previous step is displayed, and the interval time is count down. When the interval time reaches 0 s, the next step is executed.

If the interval time is set to HOLD, the next step will not start until you press the START switch.

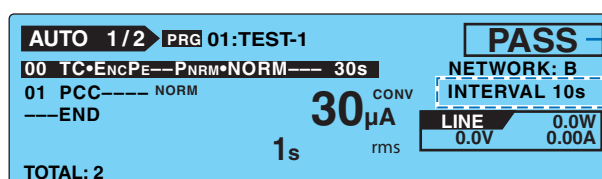

Indicates the test result of the previous step.

Displays a countdown of the interval time.
HOLD is displayed if set to hold.

When a test starts (Cont'd)

The measured value is blinking

See p. 82

If the measured value exceeds the measurement range specified by AUTO or FIX, the measured value will blink. See Table 6-2.

CONV is displayed

See p. 200

If the current conversion display function is enabled and the power is not applied to the AC inlet for the EUT, "CONV" will be displayed. The conversion display function is invalid in this condition.

If you are supplying the EUT power from an external source (not from the TOS3200) in the TC measurement between two enclosures, turn the current conversion display function off.

- SYSTEM1/5>CONV

Unable to Start the Test

READY is not displayed

You will not be able to start test in the following conditions.

See p. 96

- When AUTO2/2 is displayed.
- When the STOP switch is pressed (includes the condition in which the STOP signal is being applied to the SIGNAL I/O connector).
- When the power line of the EUT is turned on.

See p. 44

PROTECTION is blinking

See p. 204

If "PROTECTION" is blinking on the screen, the TOS3200 is in the protection status. You will not be able to start the test in this status. Eliminate the cause of the protection status, and then start the test. For details, see "Protection Function".

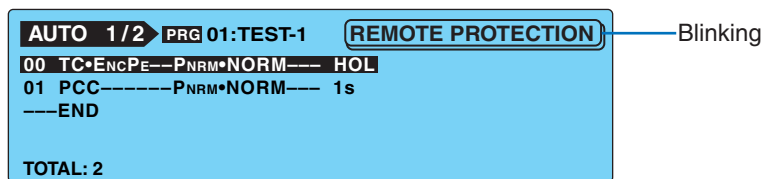

PASS or FAIL is displayed

You cannot start test while the judgment result is displayed. Press the STOP switch to set the TOS3200 to READY status.

Stopping the Test

Aborting the Test

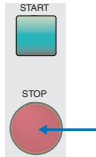

Press the STOP switch.

When the Test Ends

The program test will stop in any of the conditions below.

- When the execution of all steps has been completed.
- If U-FAIL, L-FAIL, or CONTACT FAIL occurs (when ABORT is ON).
- When you press the STOP switch.

When the program test stops, the DANGER lamp will turn off, and the power line to the EUT will be turned off.

If the test stops in the case of condition a or b above, the total judgment result will be displayed on the screen.

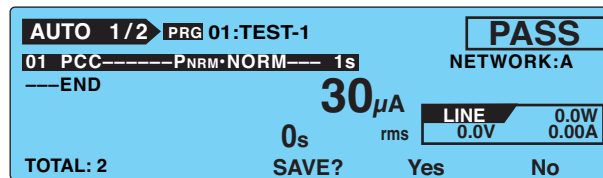

Program Test Judgment

In a program test, the measured value is judged for each step, and the result is displayed. When all steps are completed, the total judgment of all steps is made.

Table 6-3 Operation when the step is completed or the program test is completed

Operation	PASS	L-FAIL	U-FAIL	CONTACT FAIL
Display	Displays "PASS" on the screen.	Displays "↓FAIL" on the screen.	Displays "↑FAIL" on the screen.	Displays "↓FAIL" on the screen.
Buzzer (only when the program test is completed)	Sounds for 0.2 s. ¹	Sounds until FAIL is cleared.		
SIGNAL I/O connector	Outputs the pass signal for the time specified by PASS HOLD.	Outputs the L-FAIL signal until FAIL is cleared.	Outputs the U-FAIL signal until FAIL is cleared.	Outputs the L-FAIL and U-FAIL signals until FAIL is cleared.

*1 The duration of the buzzer for a PASS judgment is fixed to 0.2 s. It does not depend on the PASS HOLD time.

Program Test Judgment (Cont'd)

Judgment for each step

See p. 50

Judgment is performed in the same manner as the single test. For details, see “Judgment System”.

The judgment result of each step is displayed on the screen during the interval and also delivered as a signal from the SIGNAL I/O connector. The buzzer does not sound.

Total judgment

When the program test is complete, a total judgment of all steps is displayed. If the judgment of all steps is the same, the total judgment is also the same. If various judgments are mixed, the judgment with the highest precedence becomes the total judgment. See the following example.

Step	Judgment of each step	
	Program 00	Program 01
00	PASS	PASS
01	PASS	CONTACT FAIL
02	PASS	U-FAIL
03	PASS	PASS
04	PASS	L-FAIL
05	PASS	PASS
Total judgment	PASS	U-FAIL

Order of precedence	Judgment
1	U-FAIL
2	L-FAIL
3	CONTACT FAIL
4	PASS

ABORT setting and FAIL judgment

If ABORT is set to OFF in the example of program 01 above, the test will be executed to step 05, and the total judgment will be U-FAIL.

If ABORT is set to ON, CONTACT FAIL occurs in step 01, and the program test will stop at this point. The total judgment will be CONTACT FAIL, and the test results up to step 01 can be stored.

Storing the Test Result

See p. 93

The storage function is assigned to a function key while the judgment result is displayed. For details, see “Storing the Test Results”.

Releasing the Judgment Result

Press the STOP switch to set the TOS3200 to READY status.

Storing the Test Results

You can store up to 50 program test results. The storage function is assigned to a function key while the judgment result (PASS or FAIL) is displayed.

- 1 Press the Yes (F4) key on the judgment result screen to display the AUTO TEST DATA screen.

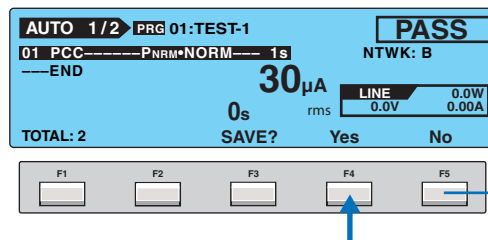

Does not save the test results.
Skips to step 4.

- 2 Press the arrow keys (▲▼◀▶) to select the desired memory number.

If you select a memory number in which a test result is already saved, the saved information is displayed.

Program number: Program name year/month/day hour:minute

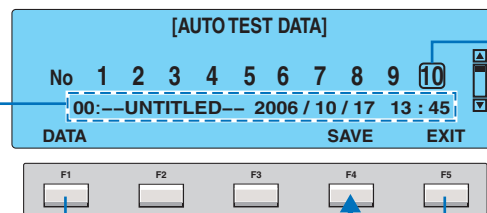

Move the box using the arrow keys to select the number.

Displays the test data of the selected memory number.

Aborts the save operation.

You can check the existing data before overwriting the existing data.

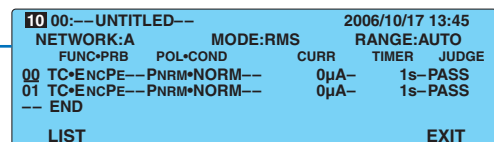

Return to the memory selection screen.

- 3 Press the SAVE (F4) key.

The saved information is displayed.

Press the DATA (F1) key to check the stored data.

- 4 Press the EXIT (F5) key.

The data save screen closes, and the TOS3200 changes to the READY status.

Displaying the Test Results

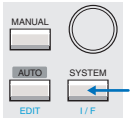

You can display the stored test results from the system setup screen 4/5 (SYSTEM4/5).

- 1 Press the **SYSTEM** key to display **SYSTEM1/5**.
- 2 Press the **<NEXT>** (F5) key three times to display **SYSTEM4/5**.

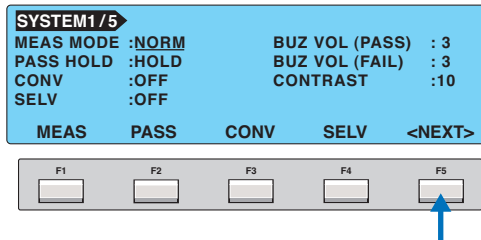

- 3 Press the arrow keys (**▲ ▼ ◀ ▶**) to select the desired memory number.

If you select a memory number in which a test result is already saved, the saved information is displayed.

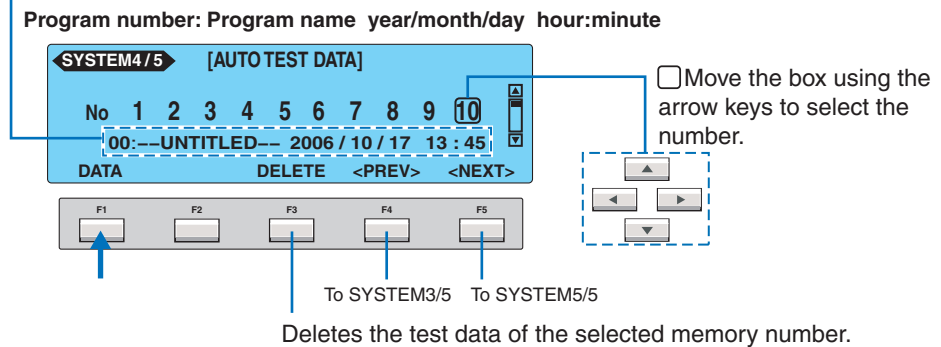

- 4 Press the **DATA (F1)** key.
The stored test results are displayed.

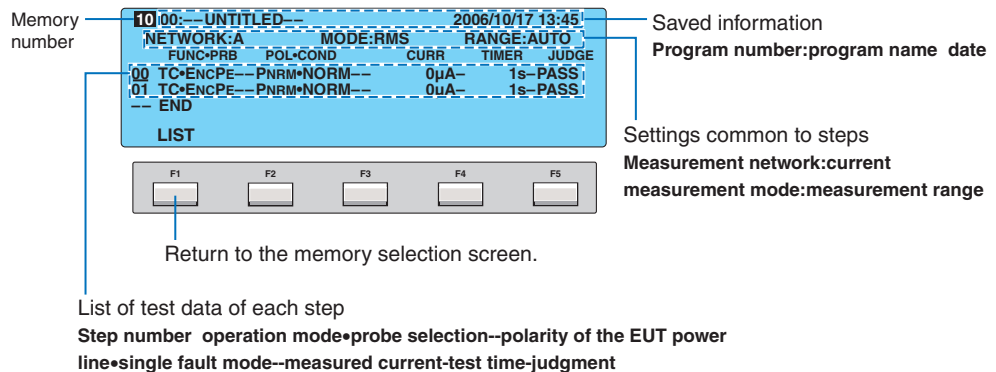

To return to the current measurement, press the **AUTO** key.

Deleting the Stored Data

Select the memory number you want to delete in step 3 above, and press the **DELETE (F3)** key.



External Control

This chapter describes how to start the test externally and how to recall panel memories and sequence programs using the SIGNAL I/O connector.

SIGNAL I/O Connector



WARNING

Possible electric shock. Turn off all equipment before connecting or disconnecting cables.

The SIGNAL I/O connector is the D-sub 25-pin connector on the rear panel.

The connector is used to control the starting and stopping of the test or monitor the TOS3200 status.

- Connector on the TOS3200
By Omron XM2B-2502 D-sub 25-pin male connector
- Connection cable
D-sub 25-pin male to D-sub 25-pin male, straight cable
- Connector on the controller
By Omron XM2D-2501 D-sub 25-pin male connector or an equivalent connector

To prevent operation errors due to noise, use a shielded D-sub 25-pin connector and a cable of length less than or equal to 3 m.

For information on how to obtain the consumable parts, contact your Kikusui agent or distributor.

For details on how to use the tools, read the catalog by Omron.

SIGNAL I/O Specifications

Input signal

Low-active control input

High-level input voltage: 11 V to 15 V

Low-level input voltage: 0 V to 4 V

Low-level input current: -5 mA maximum

Input time width: 5 ms minimum

Output signal

Open collector output

Output withstand voltage: 30 Vdc

Output saturation voltage: Approx. 1.1 V (25 °C)

Maximum output current: 400 mA (TOTAL)

Table 7-1 SIGNAL I/O connector pin arrangement

Pin No.	Signal name	I/O	Description	
1	PM0	I	LSB	2-digit BCD low-active input Signal input pins for selecting the panel memory or program This selection signal is latched on the rising edge of the strobe signal to recall the panel memory or program.
2	PM1	I	–	
3	PM2	I	–	
4	PM3	I	–	
5	PM4	I	–	
6	PM5	I	–	
7	PM6	I	–	
8	PM7	I	MSB	
9	STB	I	Strobe signal input terminal of the panel memory or program	
10	MANU/AUTO	I	Selects single test or program test. (high: single test, low: program test)	
11	STEP_END	O	Output at the end of each step during a program test.	
12	CYCLE_END	O	Output at the end of the last step during a program test.	
13	COM	–	Circuit common	
14	LINE_ON	O	On while power is supplied from AC LINE OUT to the EUT.	
15	TEST	O	On while the test is in progress (excluding the test wait time and interval period).	
16	PASS	O	On for at least 0.2 s (PASS HOLD time) when judgment is PASS. (On continuously if the PASS HOLD time is set to HOLD.)	
17	U-FAIL	O	Continuously on if the judgment is U-FAIL or CONTACT FAIL.	
18	L-FAIL	O	Continuously on if the judgment is L-FAIL or CONTACT FAIL.	
19	READY	O	On during the READY status.	
20	PROTECTION	O	On when a protection is activated.	
21	START	I	Start signal input pin.	
22	STOP	I	Stop signal input pin.	
23	ENABLE	I	Enable signal input pin of the start signal.	
24	+24 V	O	+24-V internal power supply output terminal (maximum output current: 100 mA)	
25	COM	–	Circuit common	

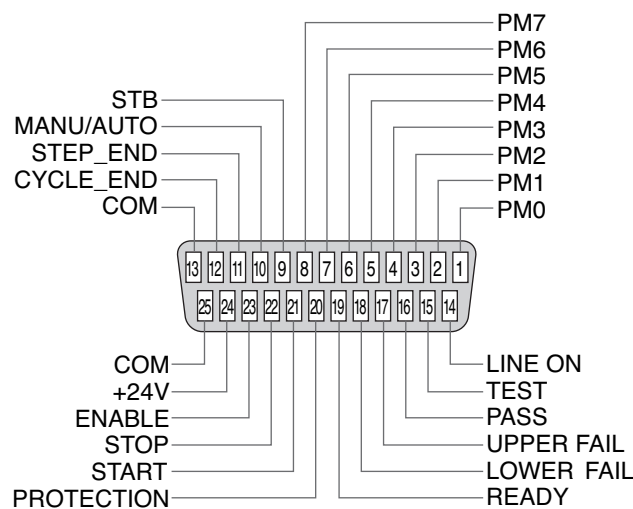

Possible damage to internal circuit. Do not short the +24 V of pin number 24 to the chassis or the circuit common.

Internal Construction

The common for the input signal circuit and output signal circuit is the same.

It is pulled up to +12 V. If the input terminal is opened, the input signal circuit will be in the same condition as when a high level signal is applied.

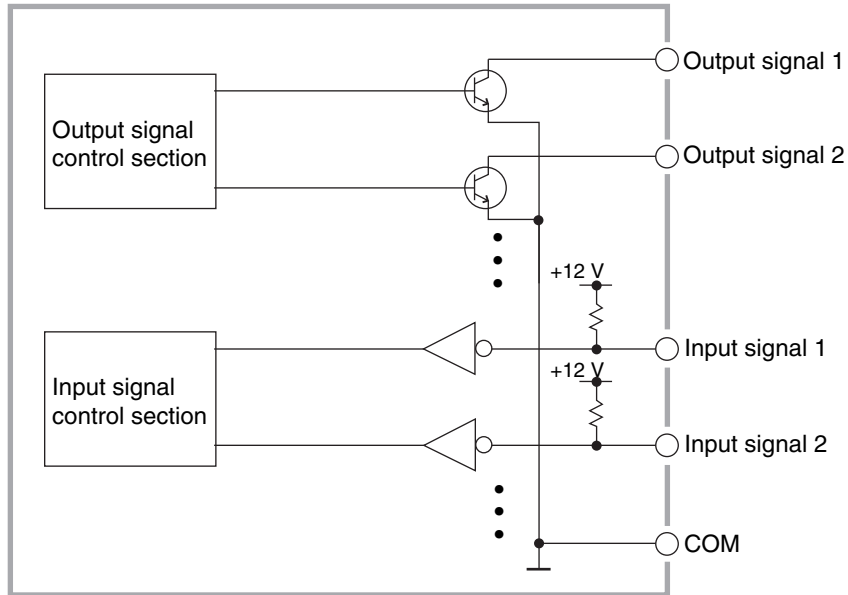
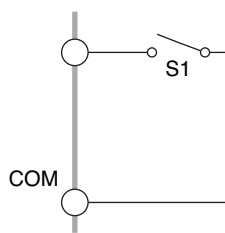

Fig. 7-1 Internal construction of SIGNAL I/O

Application Examples of Input Signal

Controlling the TOS3200 using a make contact



The input terminal is set to low level by using a make contact such as a relay or switch.

Controlling the TOS3200 using a logical device

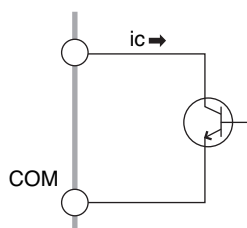

In place of a switch in the example above, a logical device such as a transistor is used.

Construct the circuit so that at least 5 mA of collector current i_c of the transistor can flow.

Application Examples of Output Signal

Driving a relay

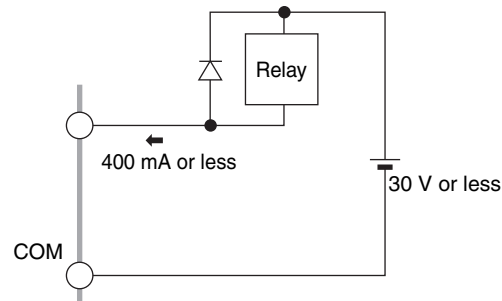

The output signal is used to drive a relay.

Producing a low level digital signal

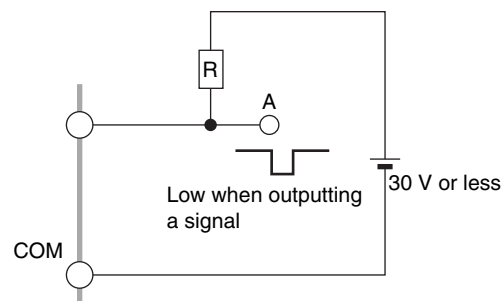

The output signal is used to produce a low level digital signal.

Starting the Test

To start the test using the SIGNAL I/O connector, set the ENABLE signal to low level. When at least 10 ms passes after the READY signal is set to low level, set the START signal to low level for at least 5 ms. When a valid START signal is detected, the READY signal will be set to high level.

If the ENABLE signal is low level, the start signal of the SIGNAL I/O connector and the START input of the REMOTE terminal will be enabled, and the START switch on the panel will be disabled.

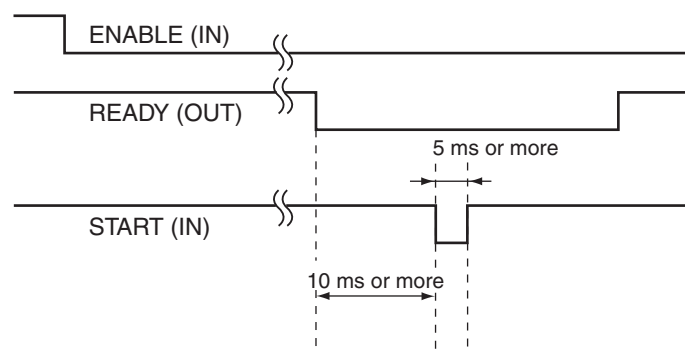

Fig. 7-2 START signal

Recalling the Panel Memory and Sequence Program

The PM and STB signals are processed at the times shown below. Check that the READY signal is low level.

Table 7-2 shows the relationship between the PM0 to PM7 signals and the panel memory number or program number that is actually recalled.

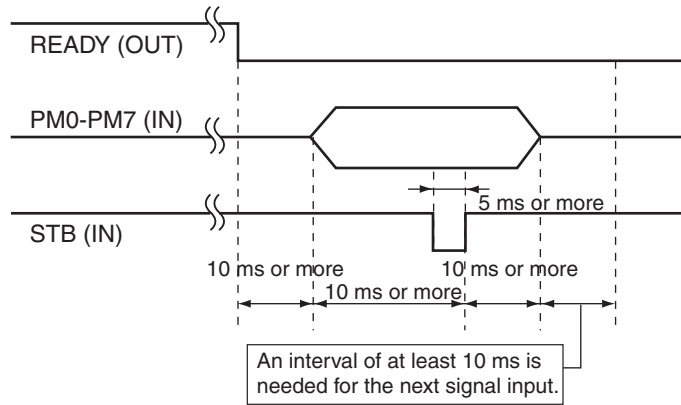
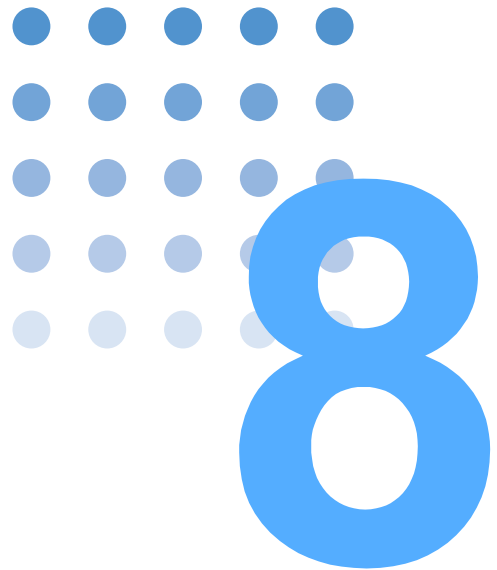

Fig. 7-3 Strobe signal

Table 7-2 Panel memory and program selection

MSD				LSD				MANU/AUTO	Recalled data
PM7	PM6	PM5	PM4	PM3	PM2	PM1	PM0		
H	H	H	H	H	H	H	H	H	Panel memory 00
								L	Program 00
H	H	H	H	H	H	H	L	H	Panel memory 01
								L	Program 01
H	H	H	H	H	H	L	H	H	Panel memory 02
								L	Program 02
⋮									
L	H	H	L	L	H	H	H	H	Panel memory 98
								L	Program 98
L	H	H	L	L	H	H	L	H	Panel memory 99
								L	Program 99



Remote Control

This chapter gives an overview of the remote control function and explains the SCPI command structure, syntax, details of each command, registers, and so on used in the remote control.

Remote Control Overview

In addition to using the front panel, the TOS3200 can be controlled remotely using the following interfaces (equipped as standard).

- RS232C interface
- GPIB interface
- USB interface

The GPIB, RS232C, and USB interfaces cannot be used simultaneously.

The remote interface complies with IEEE Std 488.2-1992 and SCPI Specification 1999.0.

 See p. 110

Use the SCPI commands only after you have understood the SCPI command syntax for the TOS3200.

If the TOS3200 is operating under remote control, the RMT LED on the front panel will illuminate. To switch from the remote mode to the local mode (panel operation) from the panel, press the LOCAL key.

Instrument Interface Standards

The TOS3200 conforms to the following standards.

- IEEE Std 488.2-1992 IEEE Standard Codes, Formats, Protocols, and Common Commands For Use With IEEE Std 488.1-1987
- IEEE Std 488.1-1987 IEEE Standard Digital Interface for Programmable Instrumentation
- Standard Commands for Programmable Instruments (SCPI) version 1999.0
- Universal Serial Bus Specification Rev 2.0
- Universal Serial Bus Test and Measurement Class Specification (USBTMC) Rev 1.0
- Universal Serial Bus Test and Measurement Class, Subclass USB488 Specification (USBTMC-USB488) Rev 1.0

VISA Library

If you are using a VISA library (VISA COM) for the I/O library, the VISA library must be installed on the PC.

A device driver supporting USB T&M Class (USBTMC) is required to control the TOS3200 through the USB interface. The USBTMC driver is automatically installed by the VISA library. VISA (Virtual Instrument Software Architecture) is a specification for standard software for connecting instruments that was defined by the VXIplug&play Systems Alliance.

One of the VISA libraries (driver software implemented in compliance with the VISA specifications) below is necessary.

Older version of VISA libraries does not support USB. USB functions cannot be used on Windows 95 or Windows NT 3.5x or 4.0.

- NI-VISA by National Instruments (Ver. 3.0 or later, Ver. 3.2 or later for Windows 2000 and Windows XP)
- Agilent VISA by Agilent Technologies (Agilent IO Libraries M01.00 or later)
- KI-VISA Ver. 3.0.0 or later

KI-VISA is Kikusui original VISA library compatible with VXIplug&play VISA Specifications 3.0. The latest version can be downloaded from Kikusui website (<http://www.kikusui.co.jp/en/download/>). KI-VISA is not required if NI-VISA or Agilent VISA is already installed.

Using the RS232C Interface

The RS232C port on the TOS3200 is a standard D-sub 9-pin male connector.

Check that the POWER switches of the TOS3200 and the PC are off, and connect the TOS3200 to the PC using a standard cross cable (null modem cable).

Use a D-sub 9-pin female-to-female AT type for the cross cable. Fig. 8-1 shows the connector pin assignments.

The TOS3200 does not use hardware handshaking (cross cable example 2).

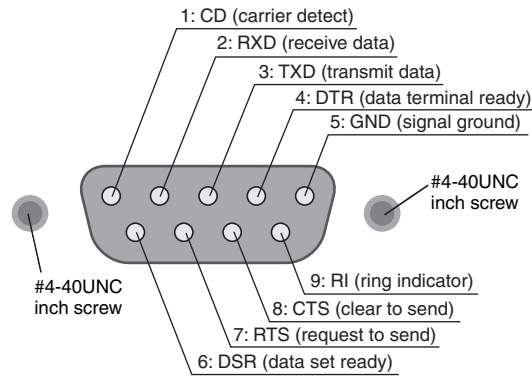

Facing the TOS3200 rear panel

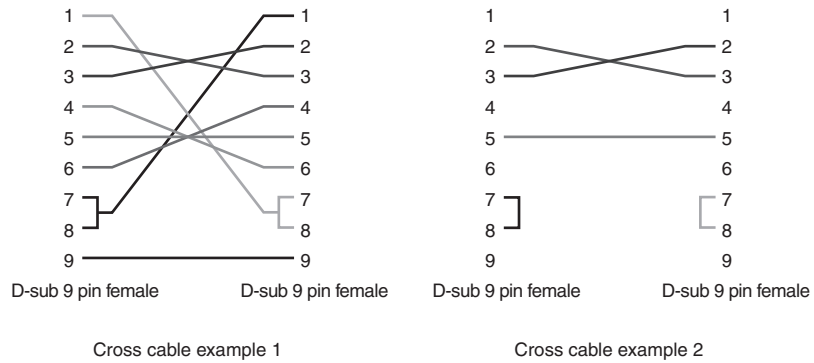
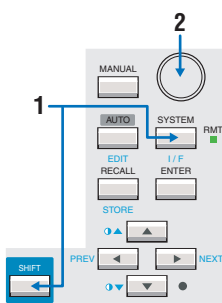

Fig. 8-1 9-pin AT type connector



1 Press the I/F (SHIFT+SYSTEM) key to display the interface setup screen (INTERFACE).

2 Press the SHIFT+F1 key or turn the rotary knob to select RS232C.

3 Set the RS232C protocol and communication error trace function.

The settings of the communication error trace function are common to all interfaces. You cannot set it separately for each interface.

4 Turn the power off and turn it back on.

The settings are fixed. The communication error trace function is set even if you do not turn the power off.

```

INTERFACE
I/F SELECT:RS232C
BAUDRATE :19200      ERR TRACE:OFF
DATA BITS :8         X-FLOW :ON
TALK MODE :ON       STOP BITS :1
SELECT  BAUD  DATA  X-FLOW  STOP
  
```

Item	Description	Panel operation
I/F SELECT	Sets the interface that you are going to use.	
	USB	USB (see p. 109 to use the USB.)
	RS232C	RS232C
	GPIB	GPIB (see p. 107 to use the GPIB.)
SPEED	Sets the baud rate.	
	Baud rate	38400, 19200, or 9600
DATA BITS	Sets the data length.	
	Bit	8 or 7
X-FLOW	Sets the flow control. (see p. 106 for details on the flow control.)	
	ON	Enable the flow control.
	OFF	Disable the flow control.
STOP BITS	Sets the stop bit.	
	Bit	2 or 1
TALK MODE	Sets the talk mode. (see p. 106 for details on the talk mode.)	
	ON	Respond automatically
	OFF	No output response
ERR TRACE	Sets the communication error trace function. (Common to all interfaces.)	
	Sets whether or not to display error numbers on the screen when there are errors in the error queue.	
	ON	Enable the error number display.
	OFF	Disable the error number display.

Flow control

Use flow control for RS232C communication. DC (device control) codes are used as control codes.

Transmission/reception may not work correctly through unilateral transmission.

Code	Function	ASCII code
DC1 (Xon)	Transmission request	11H
DC3 (Xoff)	Transmission stop request	13H

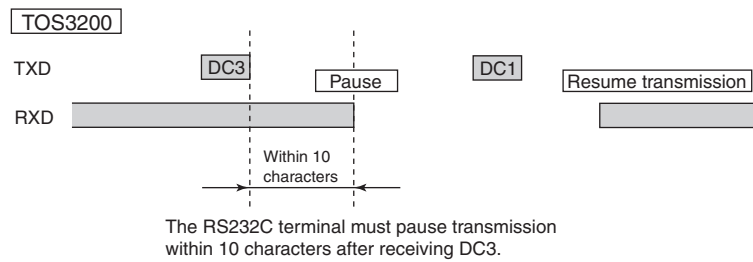

Fig. 8-2 RS232C terminal and transmission control of the TOS3200

Talk mode

Processing on the PC can be reduced by using talk mode, because commands do not need to be sent from the PC. If you connect a serial printer to the TOS3200, the test log can be printed directly.

If talk mode is turned on, the TOS3200 cannot be controlled from the PC. If you want to remotely control the TOS3200 from a PC, be sure to turn talk mode off.

- Talk mode off (default)
Responds only to the commands from the PC.
- Talk mode on
Responds automatically at the start and end of the test.
Response when a test is started: START
Response when a test ends: PROTECT, PASS, U_FAIL, L_FAIL, C_FAIL (CONTACT FAIL), or STOP

Break signal

The break signal functions as a substitute for the IEEE488.1 dcl/sdc (Device Clear, Selected Device Clear) message.

Using the GPIB Interface

Use a standard IEEE488 cable to connect the TOS3200 to the PC.

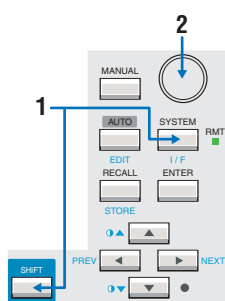

- 1** Press the I/F (SHIFT+SYSTEM) key to display the interface setup screen (INTERFACE).
- 2** Press the SHIFT+F1 key or turn the rotary knob to select GPIB.
- 3** Set the GPIB address and communication error trace function.
The settings of the communication error trace function are common to all interfaces. You cannot set it separately for each interface.
- 4** Turn the power off and turn it back on.
The settings are fixed. The communication error trace function is set even if you do not turn the power off.

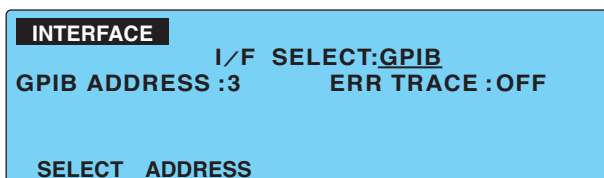

Item	Description	Panel operation
I/F SELECT	Sets the interface that you are going to use.	
	USB	USB (see p. 109 to use the USB.)
	RS232C	RS232C (see p. 104 to use the RS232C.)
	GPIB	GPIB
GPIB ADDRESS	Sets the GPIB address.	
	Address	Selectable range: 1 to 30
ERR TRACE	Sets the communication error trace function. (Common to all interfaces.) If an error is present in the error queue, the error number will be displayed on the screen.	
	ON	Enable the error number display.
	OFF	Disable the error number display.

GPIB function

Function	Subset	Description
Source handshaking	SH1	Full capability
Acceptor handshaking	AH1	Full capability
Talker	T6	Function available
Listener	L4	Function available
Service request	SR1	Full capability
Remote local	RL1	Full capability
Parallel polling	PP0	No capability
Device clear	DC1	Full capability
Device trigger	DT1	Full capability
Controller	C0	No capability
Electrical interface	E1	Open collector driver

Service request

Service request and serial polling functions are implemented.

Using the USB Interface

See p. 103

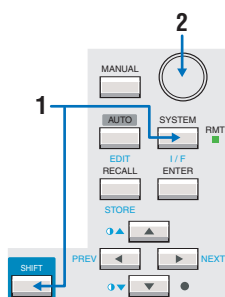

A device driver supporting USB T&M Class (USBTMC) is required to control the TOS3200 through the USB interface. The USBTMC driver is automatically installed by the VISA library.

- 1 Press the I/F (SHIFT+SYSTEM) key to display the interface setup screen (INTERFACE).**
- 2 Press the SHIFT+F1 key or turn the rotary knob to select USB.**
You can check the vendor ID, product ID, and serial number of the TOS3200.
- 3 Sets the communication error trace function.**
The settings of the communication error trace function are common to all interfaces. You cannot set it separately for each interface.
- 4 Turn the power off and turn it back on.**
The settings are fixed. The communication error trace function is set even if you do not turn the power off.

```

INTERFACE
  I/F SELECT:USB
  VENDER ID :0x0B3E   ERR TRACE:OFF
  PRODUCT ID :0x1010
  SERIAL No. :
  SELECT
    
```

Item	Description	Panel operation
I/F SELECT	Sets the interface that you are going to use.	F1 key
	USB USB	
	RS232C RS232C (see p. 104 to use the RS232C.)	SHIFT+F1 key
	GPIB GPIB (see p. 107 to use the GPIB.)	
ERR TRACE	Sets the communication error trace function. (Common to all interfaces.) If an error is present in the error queue, the error number will be displayed on the screen.	SHIFT+F4 key
	ON Enable the error number display.	
	OFF Disable the error number display.	SHIFT+F4 key

USB function

Complies with USB Specification 2.0.
 Complies with USBTMC Specification 1.0 and USBTMC-USB488 Specification 1.0.
 Data rate: 12 Mbps maximum (full speed).
 VID (vendor ID): 0x0B3E
 PID (product ID): 0x1010.

Service request

Service request and serial polling functions are implemented.

Overview of Messages

The information that is exchanged between the PC and the TOS3200 is called a message.

The TOS3200 uses the SCPI language for the messages.

There are two types of messages, commands that are sent from the PC to the TOS3200 and responses that are sent from the TOS3200 to the PC.

Commands are used to execute functions of the TOS3200, change settings, and query settings and statuses. Responses return the settings and statuses of the TOS3200.

SCPI Command Syntax

Command hierarchy

The SCPI is an ASCII-based command language designed for test and measurement devices. The command hierarchy is structured around the common root or node, which is the construction block of the SCPI sub system. A command consists of a program header, parameters, and punctuations.

The hierarchy is explained using the SYSTem subsystem as an example.

Program header	Parameter	Node hierarchy
:SYSTem		Root node
:BEEP		2nd level
:VOLume		3rd level
:FAIL	<numeric>	4th level
:PASS	<numeric>	4th level
:DATE	<nrf>,<nrf>,<nrf>	2nd level
:ERRor		2nd level
[:NEXT]	<code>, "<description>"	3rd level

A higher node is separated from a lower node using a colon (:).

Command syntax

This manual denotes SCPI commands using the following format.

(Example)

SYSTem:BEEP:VOLume:FAIL {<numeric>|MINimum|MAXimum}

- There are two forms of SCPI commands, the long form in which the command is written out in its entirety and the short form in which the letters written in lowercase are omitted. SCPI commands can be sent in the long form or short form.
- SCPI commands are not case sensitive. VOL, Vol, and vol are all accepted as short forms of VOLTage. VOLUME, Volume, volume are all accepted as long forms.
- A space is required between the program header section and the parameter section.
- Multiple parameters, when available, are concatenated using commas.
- Compound commands can be created by concatenating two commands with a semicolon.

(Example)

SYSTem:BEeP:VOLume:FAIL MINimum;PASS MINimum

This compound command is the same as entering the following two commands.

SYSTem:BEeP:VOLume:FAIL MINimum

SYSTem:BEeP:VOLume:PASS MINimum

The first command, SYSTem:BEeP:VOLume:FAIL, sets the path to SYSTem:BEeP:VOLume. Therefore, SYSTem:BEeP:VOLume, can be omitted in the second command.

An error occurs if a node that is not defined in the current path (except FAIL and PASS) is designated.

- A colon is required between program headers.
- Commands of different subsystems can be concatenated using colons and semicolons.

(Example)

SYSTem:CONFIgure:PHOLd MINimum;:MEASure:CURRent?

This compound command contains two root nodes, SYSTem and MEASure.

If the second or subsequent command starts with a colon, the path specified by the previous command will be cleared.

- The maximum number of characters that can be transmitted in a single line is 128.

Special symbols and characters

Special symbols and characters used in this manual to describe SCPI commands are defined as indicated in the following.

Symbols or characters	Description
< >	Characters strings inside the < and > symbols indicate program data. Do not include these symbols in the actual program.
{ }	Characters and numbers delimited by “ ” in braces indicate that one of the items is to be selected. Do not include the braces in the actual program.
[]	Characters strings inside brackets indicate optional data. When option data is not sent with the program, the default value will be sent. Do not include the brackets in the actual program.

Query

The device settings or status can be queried.

To make a query, add a question mark at the end of the program header section. If a query has parameters, enter a space after the question mark followed by the parameters.

(Example)

CURRent? MIN

NOTE

When transmitting two queries in separate lines, read the response to the first query before transmitting the second line. If you send two lines of query commands at once, an incomplete response may be received.

SCPI Command Syntax (Cont'd)

String termination

All commands must be terminated using a valid terminator.

The available terminators are <line feed> (ASCII 0x0A) and EOI (end-of-identify). Either one can be used as a terminator.

Because EOI is not available on the RS232C, be sure to use <line feed>.

If a command string is terminated, the path will be reset to the root level.

NOTE

CR (ASCII 0x0D) is not a terminator.

Common commands

See p. 115

The IEEE-488.2 and SCPI standards contain a set of common commands for reset, self-test, and other functions. These common commands always start with an asterisk. The commands may have one or multiple parameters.

Parameters

The parameter format of SCPI is derived from the program parameter format defined in IEEE 488.2.

The representation system of the program data that is used on the TOS3200 is indicated below.

Non-numeric parameters

The TOS3200 uses the following three types of non-numeric parameters.

Symbols or characters	Description
Character string data (String)	Used when a series of ASCII characters are requested. Be sure to enclose a string in single quotations or double quotations. The start and end quotation marks must match. (Example) <code>NETWork "A"</code> If you want to use a quotation mark as a part of the string, enter two quotation marks consecutively (with no characters in between). ASCII codes 20H to 7EH can be used.
Character data (Character)	Used when only a limited number of values is available for the program setting. Responses are returned in the short form. (Example) <code>CURRent:RANGe:SElect {LOW MEDIum HIGH}</code>
Boolean data (Boolean)	Expresses a 1 or 0 condition or an ON or OFF condition. Responses are returned as 1 or 0. (Example) <code>SYSTem:CONFIgure:TRACe {ON OFF 1 0}</code>

Numeric parameters

The TOS3200 uses the following five types of numeric parameters.

Symbols or characters	Description
NR1	Represents an integer.* ¹
NR2	Represents a real number (floating point).* ¹
NR3	Represents a real number (exponential).* ¹ The value +3.80000+E02 is returned for the response data 380. The number of digits to the right of the decimal is 5.
NRf	NRf is a generic term that includes NR1, NR2, and NR3.
Numeric	Represents a decimal point, optional sign, and measurement unit. The numeric representation syntax is the same as NRf. MINimum and MAXimum are available as substitutes for declaring certain values. Units such as V, A, and S can also be used in a numeric parameter. If a value that cannot be assigned is entered, the device will round the value to the closest possible value. (Example) <code>SYSTem:BEEPer:VOLume:FAIL 20</code> The range of values for <code>SYST:BEEP:VOL:FAIL</code> is 0 to 10. Thus, 10 is set even if 20 is specified.

*1. Details are given in the *IEEE 488.2 Standard Digital Interface for Programmable Instrumentation*.

Special form numeric parameter

The special form numeric parameters MINimum and MAXimum can be used as substitutes for limit values when the parameter is numeric.

In the example below, the buzzer volume for FAIL judgments is to the minimum value.

SYSTem:BEEPer:VOLume:FAIL MINimum

The minimum and maximum values can be inquired for most parameters using queries.

CURRent:LIMit:UPPer? MAX

Measurement unit

Below are the default measurement units. Commands will be accepted even if measurement units are not specified.

- A (current)
- V (voltage)
- W (wattage)
- S (second)

The following optional prefixes are supported. To enter “μ” in the parameter, use “U” instead.

- M (milli)
- U (micro)

NOTE

The unit symbols in the International System of Units contain lowercase characters. The IEEE standard uses uppercase characters. SCPI commands are not case sensitive.

Command Description in This Manual

This manual describes the commands in the following manner.

Attach the value you want to specify after the command and send the command.
To set the test time to **20 s** in the touch current measurement, send **TC:TIM 20**.

TC:TIM / PCC:TIM

Commands with these marks will be affected if *RST or *RCL is sent. The settings will be changed to the default values indicated on page 196.
The test time will be changed to 10 s if *RST is sent.

***RST *RCL**

Set the test time. TC:TIM:ST This setting is valid when TC:TIM:STAT or PCC:TIM:STAT is on.

The commands are given in the long form.
The lower-case section can be omitted.
The section enclosed by braces ([]) can also be omitted.

Command

```
[SENSe:]TC:TIMer {<numeric>|MIN|MAX}
[SENSe:]TC:TIMer? {MIN|MAX}
[SENSe:]PCC:TIMer {<numeric>|MIN|MAX}
[SENSe:]PCC:TIMer? {MIN|MAX}
```

The parameters are listed.
In the case of this command, the parameter is numeric. In addition to specifying the desired value, you can specify the minimum or maximum value.

Touch current measurement command

Protective conductor current measurement command

Parameter

Specify MAX to set the maximum value.

Value: 1 to 999 (The default value is 10.)

The selectable range is given.
Optional symbols such as m and μ can also be used.

Specify MIN to set the minimum value.

Unit: S

The unit for the value. The unit can be omitted.

Table A-4 shows the setting that is specified when *RST or *RCL is sent.

This command is affected if *RST is sent, and the setting changes to the value indicated in Table 7-9.
The test time is changed to 10 s if *RST is sent.

Response

Returns the test time in the <NR3> form in response to TC:TIM? or PCC:TIM?.

The representation system of the value that is returned when a query is sent.

Command items and reference pages

Item	See Page
Command syntax	p. 110
Parameter	p. 112
Unit	p. 113
Default values	p. 196
Query	p. 111
Representation system	p. 112
List of messages	p. 186
List of errors	p. 192

IEEE488.2 Common Commands

*CLS

Clears all event registers including the status byte, event status, and error queue.

 p. 150

Command *CLS

*ESE

 p. 153

Sets the event status register that is counted by the event summary bit (ESB) of the status byte.

Command *ESE <NR1>
*ESE?

Parameter

Parameter Value: 0 to 255
An SCPI error (-222, "Data out of range") occurs if outside the range.

(Example) When *ESE 16 is transmitted, bit 4 of the event status enable register is set. Each time the execution error bit (bit 4) of the event status register is set, the summary bit (ESB) of the status byte is set.

Response Returns the value of the event status enable register in the <NR1> form.

*ESR

 p. 153

Queries the event status register. Registers that are read are cleared.

Command *ESR?

Response Returns the value of the event status register in the <NR1> form and clears the register.

*IDN

Queries the model name, serial number, and firmware version of the TOS3200.

Command *IDN?

Response The response to *IDN? is indicated below.

(Example) For TOS3200 with a serial number AB123456 and firmware version 1.00
Returns KIKUSUI,TOS3200,AB123456,1.00.

***OPC**

Section 12.5.3 in
IEEE 488.2-1992

Sets the OPC bit (bit 0) of the event status register when the processing of all commands standing by is complete.

Command *OPC
*OPC?

Response Returns 1 when the processing of all commands standing by is complete.

***OPT**

Queries the option (HP21-TOS only) that is installed in the TOS3200.

Command *OPT?

Response If the HP21-TOS is installed, "HP21-TOS" is returned. Returns 0 if the option is not installed.

***RCL**

Aborts the measurement operation and reads the contents stored in memory. The operation is the same as MEM:RCL.

Command *RCL <NR1>

Parameter Value: 0 to 99 Memory number
An SCPI error (-222, "Data out of range") occurs if outside the range.

***RST**

p. 196

Aborts the measurement operation and initializes the TOS3200 to factory default condition. For the commands that are affected by *RST, see "Default values".

Command *RST

***SAV**

p. 196

Stores the present TOS3200 settings to memory. The operation is the same as MEM:SAV. The settings that are stored are the same as those recalled using the *RCL command. See "Default values".

Command *SAV <NR1>

Parameter Value: 0 to 99 Memory number
An SCPI error (-222, "Data out of range") occurs if outside the range.

***SRE**

Sets the service request enable register.

The service request enable register is used to select the summary messages in the status byte register that will be able to perform service requests.

To clear the service request enable register, send *SRE 0. If the register is cleared, service requests cannot be generated by status information.

Command *SRE <NR1>
*SRE?

Parameter Value: 0 to 255
An SCPI error (-222, "Data out of range") occurs if outside the range.

(Example) Sending *SRE 8 sets bit 3 of the service request enable register. Each time the summary bit (bit 3) of the QUEStionable status register in the status byte is set, a service request message is generated.

Response Returns the value of the service request enable register in the <NR1> form.

*STB

 p. 152

Queries the contents of the status byte register and the MSS (master summary status) message.

The response is the same as serial polling only with the exception that the MSS message appears in place of the RQS message in bit 6.

Command *STB?

Response Returns the value of the status byte register and the MSS message (bit 6) in <NR1> form.

*TRG

 Section 10.37 in
IEEE 488.2-1992

Trigger command.

This is a substitute command for the IEEE488.1 get message (Group Execute Trigger).

If the TOS3200 is not in a condition to accept triggers, an SCPI error (-211, "Trigger ignored") will occur.

Command *TRG

*TST

 Section 10.38 in
IEEE 488.2-1992

Executes a self-test. Use SYST:ERR? to query the errors that occurred.

Command *TST?

Response Returns 0 if there are no errors. If there are, the error code is returned.

*WAI

Prevents the TOS3200 from executing subsequent commands until all operations in standby are complete.

Command *WAI

Selecting the Operation Mode

FUNC

*RST *RCL

Sets the operation mode.

Command [SENSe:]FUNction[:ON] "{CURRent|PCC|TC|VOLTage|AUTO}"
[SENSe:]FUNction[:ON]?

Parameter "CURRent" Current measurement (Meter Mode)
"PCC" PCC Measurement Mode
"TC" TC Measurement Mode (default)
"VOLTage" Voltage measurement (Meter Mode)
"AUTO" Program test

Response Returns the operation mode in the <string> form.
If the TOS3200 is displaying the SYSTEM or INTERFACE screen, "" will be returned.

Setting the TC Measurement and PCC Measurement

The commands with "TC" in the second-level node are for TC measurement. Commands with "PCC" are for PCC measurement.

Setting the Connection Destination of the Measurement Terminal (TC measurement only)

TC:PROB

*RST *RCL

Sets the connection destination (PROBE) of measurement terminals A and B.

Command [SENSe:]TC:PROBe {ENCPE|ENCENC|ENCLIV|ENCNEU}
[SENSe:]TC:PROBe?

Parameter Value: ENCPE Between the enclosure and earth (default)
ENCENC Between two enclosures
ENCLIV Between the enclosure and power line (live)
ENCNEU Between the enclosure and power line (neutral)

Response Returns the connection destination of the measurement terminal in the <character> form.

Setting the Power Line Polarity

TC:POL / PCC:POL

*RST

*RCL

Sets the polarity (POL) of the power line supplied to the EUT. If you set the connection destination of the measurement terminal to between the enclosure and power line, this command will be invalid.

Command [SENSe:]TC:POLarity {NORMal|REVersed}
 [SENSe:]TC:POLarity?
 [SENSe:]PCC:POLarity {NORMal|REVersed}
 [SENSe:]PCC:POLarity?

Parameter	Value:	NORM	Normal phase connection (default)
		REV	Reverse phase connection

Response Returns the polarity of the power line in the <character> form. If the connection destination of the measurement terminal is set to between the enclosure and power line, NA is returned.

Setting the Single Fault Mode

TC:COND / PCC:COND

*RST

*RCL

Sets the single fault mode (COND). If you set the connection destination of the measurement terminal to between the enclosure and power line, this command will be invalid.

Command [SENSe:]TC:CONDition {NORMal|FLTNEU|FLTPE}
 [SENSe:]TC:CONDition?
 [SENSe:]PCC:CONDition {NORMal|FLTNEU}
 [SENSe:]PCC:CONDition?

Parameter	Value:	NORMal	Normal condition (default)
		FLTNEU	Power line (neutral) disconnected condition
		FLTPE	Earth line disconnected condition (TC Measurement Mode only)

Response Returns the single fault mode in the <character> form. If the connection destination of the measurement terminal is set to between the enclosure and power line, NA is returned.

Setting the Lower Reference

TC:LIM:LOW / PCC:LIM:LOW

*RST *RCL

Sets the lower limit of the judgment reference (lower reference). This setting is valid when TC:LIM:LOW:STAT or PCC:LIM:LOW:STAT is on.

For TC measurement, the setting varies depending on the measurement network and current measurement mode settings. For PCC measurement, the setting varies depending on the current measurement mode setting.

Command [SENSe:]TC:LIMit:LOWer[:LEVel] {<numeric>|MIN|MAX}
 [SENSe:]TC:LIMit:LOWer[:LEVel]? {MIN|MAX}
 [SENSe:]PCC:LIMit:LOWer[:LEVel] {<numeric>|MIN|MAX}
 [SENSe:]PCC:LIMit:LOWer[:LEVel]? {MIN|MAX}

Parameter Value: Varies depending on the current measurement mode and the measurement network settings. (The default value is 30 μ .)

See p. 54, p. 58

Unit: A

Response Returns the lower reference in the <NR3> form.

TC:LIM:LOW:STAT / PCC:LIM:LOW:STAT

*RST *RCL

Sets whether to perform judgment with respect to the lower reference. Set the lower reference using TC:LIM:LOW or PCC:LIM:LOW.

Command [SOURce:]TC:LIMit:LOWer:STATe {ON|OFF|1|0}
 [SOURce:]TC:LIMit:LOWer:STATe?
 [SOURce:]PCC:LIMit:LOWer:STATe {ON|OFF|1|0}
 [SOURce:]PCC:LIMit:LOWer:STATe?

Parameter Value: ON (1) Enable the judgment
 OFF (0) Disable the judgment (default)

Response Returns the whether to perform judgment with respect to the lower reference in the <NR1> form.

Setting the Upper Reference

TC:LIM:UPP / PCC:LIM:UPP

*RST *RCL

Sets the upper limit of the judgment reference (upper reference). This setting is valid when TC:LIM:UPP:STAT or PCC:LIM:UPP:STAT is on.

For TC measurement, the setting varies depending on the measurement network and current measurement mode settings. For PCC measurement, the setting varies depending on the current measurement mode setting.

Command [SENSe:]TC:LIMit:UPPer[:LEVel] {<numeric>|MIN|MAX}
 [SENSe:]TC:LIMit:UPPer[:LEVel]? {MIN|MAX}
 [SENSe:]PCC:LIMit:UPPer[:LEVel] {<numeric>|MIN|MAX}
 [SENSe:]PCC:LIMit:UPPer[:LEVel]? {MIN|MAX}

Parameter Value: Varies depending on the current measurement mode and the measurement network settings. (The default value is 30 m.)

See p. 54, p. 58

Unit: A

Response Returns the upper reference in the <NR3> form.

TC:LIM:UPP:STAT / PCC:LIM:UPP:STAT

*RST *RCL

Sets whether to perform judgment with respect to the upper reference. Set the upper reference using TC:LIM:UPP or PCC:LIM:UPP.

Command [SENSe:]TC:LIMit:UPPer:STATe {ON|OFF|1|0}
 [SENSe:]TC:LIMit:UPPer:STATe?
 [SENSe:]PCC:LIMit:UPPer:STATe {ON|OFF|1|0}
 [SENSe:]PCC:LIMit:UPPer:STATe?

Parameter Value: ON (1) Enable the judgment (default)
 OFF (0) Disable the judgment

Response Returns the whether to perform judgment with respect to the upper reference in the <NR1> form.

Setting the Test Time and Test Wait Time

TC:TIM / PCC:TIM

*RST *RCL

Sets the test time (TIMER). This setting is valid when TC:TIM:STAT or PCC:TIM:STAT is on.

Command [SENSe:]TC:TIMer[:TIME] {<numeric>|MIN|MAX}
 [SENSe:]TC:TIMer[:TIME]? {MIN|MAX}
 [SENSe:]PCC:TIMer[:TIME] {<numeric>|MIN|MAX}
 [SENSe:]PCC:TIMer[:TIME]? {MIN|MAX}

Parameter Value: 1 to 999 (The default value is 10.)
Unit: S

Response Returns the test time in the <NR3> form.

Setting the Test Time and Test Wait Time (Cont'd)

TC:TIM:STAT / PCC:TIM:STAT

*RST *RCL

Sets whether to stop the test when the time specified by TC:TIM or PCC:TIM elapses. Set the test time using TC:TIM or PCC:TIM.

Command [SENSe:]TC:TIMer:STATe {ON|OFF|1|0}
 [SENSe:]TC:TIMer:STATe?
 [SENSe:]PCC:TIMer:STATe {ON|OFF|1|0}
 [SENSe:]PCC:TIMer:STATe?

Parameter Value: ON (1) Stop the test after the test time elapses
 OFF (0) Not stop the test (default)

Response Returns the whether the test is stopped after the test time elapses in the <NR1> form.

TC:WAIT / PCC:WAIT

*RST *RCL

Sets the time until the test is actually started after the test is started (test wait time). This setting is valid when TC:WAIT:STAT or PCC:WAIT:STAT is on.

Command [SENSe:]TC:WAIT[:TIME] {<numeric>|MIN|MAX}
 [SENSe:]TC:WAIT[:TIME]? {MIN|MAX}
 [SENSe:]PCC:WAIT[:TIME] {<numeric>|MIN|MAX}
 [SENSe:]PCC:WAIT[:TIME]? {MIN|MAX}

Parameter Value: 1 to 999 (The default value is 1.)
 Unit: S

Response Returns the test wait time in the <NR3> form.

TC:WAIT:STAT / PCC:WAIT:STAT

*RST *RCL

Sets whether to start the test immediately or after the test wait time elapses. Set the test wait time using TC:WAIT or PCC:WAIT.

Command [SENSe:]TC:WAIT:STATe {ON|OFF|1|0}
 [SENSe:]TC:WAIT:STATe?
 [SENSe:]PCC:WAIT:STATe {ON|OFF|1|0}
 [SENSe:]PCC:WAIT:STATe?

Parameter Value: ON (1) Start the test after the test wait time elapses
 OFF (0) Start the test immediately (default)

Response Returns the whether the test is started immediately in the <NR1> form.

Setting the Measurement Network (TC measurement only)

TC:NETW

*RST

*RCL

Sets the measurement network (NTWK).

Command [SENSe:] TC:NETWork " {A|B|B1|C|D|E|F|G} "
[SENSe:] TC:NETWork?

Parameter	Value:	"A"	(For IEC 60990) (1.5 k Ω // 0.22 μ F) + 500 Ω (default)
		"B"	(For IEC 60990) (1.5 k Ω // 0.22 μ F) + 500 Ω // (10 k Ω + 22 nF)
		"B1"*1	(For IEC 60065) (1.5 k Ω // 0.22 μ F) + 500 Ω // (10 k Ω + 22 nF)
		"C"	(For IEC 60990) (1.5 k Ω // 0.22 μ F) + 500 Ω // (10 k Ω + (20 k Ω + 6.2 nF) // 9.1 nF)
		"D"	1 k Ω
		"E"	1 k Ω // (10 k Ω + 11.225 nF + 579 Ω)
		"F"	1.5 k Ω // 0.15 μ F
		"G"	2 k Ω

See p. 176

*1 Measures voltage U1 between the measurement network reference points.

Response Returns the measurement network in the <string> form.

Setting the Measurement Mode

TC:MODE / PCC:MODE

*RST

*RCL

Sets the current measurement mode (MODE).

Command [SENSe:] TC:MODE {RMS|DC|PEAK}
[SENSe:] TC:MODE?
[SENSe:] PCC:MODE {RMS|DC|PEAK}
[SENSe:] PCC:MODE?

Parameter	Value:	RMS	Rms measurement (default)
		DC	DC measurement
		PEAK	Peak measurement

Response Returns the current measurement mode in the <character> form.

Setting the Measurement Range

TC:RANG:SEL / PCC:RANG:SEL

*RST *RCL

Sets the measurement range (RANGE).

Command [SENSe:]TC:RANGe:SElect {AUTO|FIXed}
 [SENSe:]TC:RANGe:SElect?
 [SENSe:]PCC:RANGe:SElect {AUTO|FIXed}
 [SENSe:]CC:RANGe:SElect?

Parameter Value: AUTO Auto range switching (default)
 FIX Fixed range

 p. 55, p. 59

For TC measurement, the range is determined by the upper reference, measurement network, and current measurement mode settings.
 For PCC measurement, the range is determined by the upper reference and current measurement mode settings.

Response Returns the measurement range in the <character> form.

Querying the Settings

TC / PCC

Queries the settings.

Command [SOURce:]TC?
 [SOURce:]PCC?

Response Returns the following settings in order in the <string> form in response TC? / PCC?: measurement mode, measurement network, measurement range, connection destination, polarity, single fault mode, lower reference, lower reference on/off, upper reference, upper reference on/off, test time, test time on/off, test wait time, test wait time on/off.
 NA is always returned for the measurement network and connection destination in response to PCC?. NA may be returned for the polarity and single fault mode.
 NA may be returned for the polarity and single fault mode depending on the connection setting in response to TC?.

(Example) When the settings are as follows: measurement mode: RMS, measurement network: A, measurement range: FIX, connection destination: ENCPE, polarity: REV, single fault mode: FLTNEU, lower reference: 30 μ A, lower reference on/off: on, upper reference: 30 mA, upper reference on/off: on, test time: 1 s, test time on/off: on, test wait time: 1 s, and test wait time on/off: on

In response to TC?

Returns "RMS,A, FIX, ENCPE, REV, FLTNEU, +3.00000E-05, 1, +3.00000E-02, 1, +1.00000E+01, 1, +1.00000E+01, 1".

In response to PCC?

Returns "RMS,NA, FIX, NA, REV, FLTNEU, +3.00000E-05, 1, +3.00000E-02, 1, +1.00000E+01, 1, +1.00000E+01, 1".

Saving and Recalling from the Panel Memory

MEM:SAV

Saves the settings of the TC measurement or PCC measurement to the panel memory. By factory default, test conditions conforming to various safety standards are written to memory numbers 0 to 50. The operation is the same as *SAV.

Command `MEMory:SAV <NR1>`

Parameter Value: 0 to 99 Panel memory number

MEM:RCL

Recalls the settings of the TC measurement or PCC measurement from the panel memory. The operation is the same as *RCL.

Command `MEMory:RCL <NR1>`

Parameter Value: 0 to 99 Panel memory number

MEM:TITL

Assigns a name to the specified panel memory number. The memory name is 12 characters long. Spaces (0x20) will be automatically inserted if the name is less than 12 characters in length.

Command `MEMory:TITLe <NR1>,"<string>"`
`MEMory:TITLe? <NR1>`

Parameter <NR1>

Value: 0 to 99 Panel memory number

"<string>"

Value: Enter the program name. Double quotation, single quotation, comma, and "@" cannot be used.
Up to 12 characters.

 p. 39

Response Returns the memory name in the <string> form.

Executing the Test (Trigger Function)

See p. 118, p. 133

See p. 140

Executes the TC measurement, PCC measurement, or program measurement. The STOP switch on the front panel is valid even during remote control.

First, set the operation mode of the test using the FUNC command. For a program test, select the program number using the PROG:NAME command.

While the test is in progress, you can query the current, voltage, and power of the EUT as well as the measured current and maximum measured current between measurement terminals A and B.

The following three states are available in the execution of the test: IDLE, INITiated, and WTG.

IDLE state

The TOS3200 is in the IDLE state when the power is turned on. In this state, the trigger subsystems ignore all triggers. Sending ABOR, *RST, or *RCL command at any time also returns the trigger subsystems to the IDLE state.

The test is not executed in the IDLE state, even when TRG is sent.

INITiated state

If INIT is sent in the IDLE state, the trigger function will start and the TOS3200 will enter the INITiated state.

If the trigger source is set to IMMEDIATE, the test will start immediately.

If the trigger source is set to BUS, the TOS3200 will enter the WTG (Waiting for Trigger) state.

WTG (Waiting for Trigger) state

If a trigger is sent in the WTG state, the test will start.

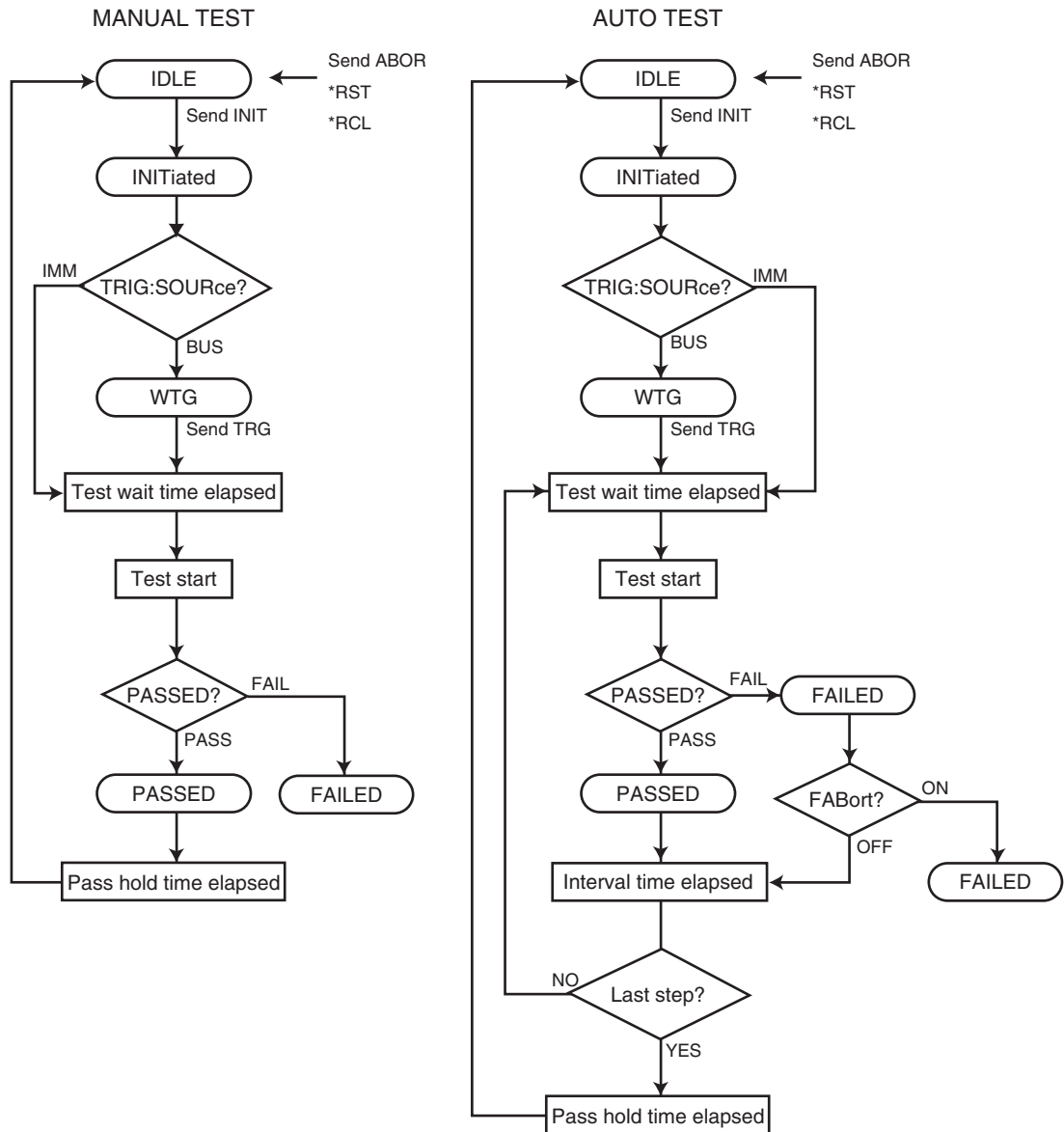

Fig. 8-3 Flow diagram of the trigger function

TRIG:SOUR

***RST *RCL**

Send the INIT or INIT:NAME TEST command first, and then set the conditions (trigger source) for actually starting the test.

Command **TRIGger[:SEquence[1]]:SOURce {IMMediate|BUS}**
TRIGger[:SEquence[1]]:SOURce?
TRIGger[:TEST]:SOURce {IMMediate|BUS}
TRIGger[:TEST]:SOURce?

Parameter Value: IMM Start the test immediately (default)
 BUS Wait for a software trigger (*TRG, TRIG, or IEEE488.1 get (Group Execute Trigger)) to start the test

Response Returns the trigger source in the <character> form.

INIT / INIT:NAME TEST

Starts the test (trigger function). The operation is the same as the INIT and INIT:NAME TEST command.

If TRIG:SOUR is set to IMM, the test will start immediately. If set to BUS, the test will start by waiting for a software trigger. If set to EXT, the test will start by waiting for an external trigger signal.

Command `INITiate[:IMMediate][:SEquence[1]]`
`INITiate[:IMMediate]:NAME TEST`

TRIG:HREL

Releases the interval hold during the program test.

Command `TRIGger[:SEquence[1]]:HRELease`
`TRIGger[:TEST]:HRELease`

DISP:SIZE

Switches the display mode while a test is in progress. This command is invalid while a program test is in progress.

Command `DISPlay:SIZE {NORMal|ENLarged}`
`DISPlay:SIZE?`

Parameter	Value:	NORMal	Standard display (default)
		ENLarged	Expanded numeric display

Response Returns the display size in the <character> form.

DISP:UXV

Sets whether or not to display the measured voltage between the reference points in expanded numeric display mode. This command is valid when the operation mode is set to current measurement or touch current measurement.

Command `CommandDISPlay:UXV {ON|OFF|1|0}`
`DISPlay:UXV?`

Parameter	Value:	ON (1)	Displays the voltage
		OFF (0)	Does not display the voltage

Response Returns whether or not the voltage is displayed in expanded numeric display mode. The value is returned in the <NR1> form.

TC:EXEC

Queries the execution status of the TC measurement test.

Command `[SENSe:]TC:EXECuting?`

Response Returns in order the test status, elapsed time, remaining time, program number, and step number in the comma-separated <character>, <elapsed time_Nr3>, <remaining time_Nr3>, <program_Nr1>, and <step_Nr1> form.

Returns -1 for the program number and step number. If TIMER OFF is selected, +9.9E+37 is returned for the remaining time.

Response form <character>
 STOP Test stopped
 WAIT Waiting for trigger
 TEST Test in progress

 <elapsed time_NR3>elapsed time, <remaining time_NR3>remaining time
 Unit: S

PCC:EXEC

Queries the execution status of the PCC measurement test.

Command [SENSe:]PCC:EXECuting?

Response Returns in order the test status, elapsed time, time remaining, program number, and step number in the comma-separated <character>, <elapsed time_NR3>, <remaining time_NR3>, <program_NR1>, and <step_NR1> form.
 Returns -1 for the program number and step number. If TIMER OFF is selected, +9.9E+37 is returned for the time remaining.

Response form <character>
 STOP Test stopped
 WAIT Waiting for trigger
 TEST Test in progress

 <elapsed time_NR3>elapsed time, <remaining time_NR3>remaining time
 Unit: S

PROG:EXEC

Queries the execution status of the program test.

Command PROGram:EXECuting?

Response Returns in order the test status, elapsed time, remaining time, program number, and step number in the comma-separated <character>, <elapsed time_NR3>, <remaining time_NR3>, <program_NR1>, and <step_NR1> form. If TIMER OFF is selected, +9.9E+37 is returned for the time remaining.

Response form <character>test status
 STOP Test stopped
 WAIT Waiting for trigger
 TEST Test in progress
 INT Interval time

 <elapsed time_NR3>elapsed time, <remaining time_NR3>remaining time
 Unit: S

ABOR

Aborts the test. The trigger status immediately after the power is turned on is the same as the condition when the ABOR command is sent.

Command ABORt

Saving and Querying the Test Result

Up to 50 test results can be saved separately for the TC measurement/PCC measurement (MANUAL TEST) and program test (AUTO TEST).

Commands with "MANual" in the second-level node are used to save or query the test results of the TC measurement or PCC measurement. Commands with "AUTO" are used to save or query the test results of the program test.

Querying the Judgment Result (Common to All Tests)

RES

Queries the judgment result of the last test.

Command `RESult[:IMMediate]?`

Response Returns the judgment result and measured current in the comma-separated <character>,<NR3> form. Returns +9.91E+37 for the measured current for CONTACT FAIL.

Response form <character>judgment result
PASS Pass judgment
LFAIL Measured a current less than or equal to the lower reference.
UFAIL Measured a current greater than or equal to the upper reference.
CFAIL CONTACT FAIL

<NR3>measured current
Unit: A

Saving the Result

RES:MAN:SAVE / RES:AUTO:SAVE

Saves the result of the last test by specifying the memory number.

The result can be saved until the next test is started. If you change the operation mode (Change between MANUAL TEST and AUTO TEST is not allowed. Change between TC and PCC is allowed.) or change the display to the SYSTEM or INTERFACE screen, the result can no longer be saved.

Command `RESult:MANual:SAVE <NR1>`
`RESult:AUTO:SAVE <NR1>`

Parameter Value: 1 to 50 Memory number

Querying the Result

RES:MAN:HEAD / RES:AUTO:HEAD

Returns the header information of the specified memory number.

Command **RESult:MANual:HEADer? <NR1>**
RESult:AUTO:HEADer? <NR1>

Parameter Value: 1 to 50 Memory number

Response Returns the items below in order from the top in the comma-separated form.

Item	Response form	Response for the TC measurement and PCC measurement
Memory name or program name	string	" " *1
Program number	NR1	-1
Total number of steps	NR1	0
Measurement network	character	Value saved to the memory
Measurement mode	character	Value saved to the memory
Measurement range	character	Value saved to the memory
Normal current measurement or maximum current hold.	character	Value saved to the memory
Total judgment	character	NA
Test start date/time.	YYYY/MM/DD hh:mm:ss	Value saved to the memory
Test end date/time.	YYYY/MM/DD hh:mm:ss	Value saved to the memory

*1. For tests executed using test conditions that were recalled from the panel memory, the panel memory name is saved as header information.

(Example) The header information saved to memory 1 of the single measurement is as follows: measurement network: A, measurement mode: RMS, measurement range: FIX, maximum current hold, test start date/time: 2006/12/1 10:00:00, and test end date/time: 2006/12/1 10:00:10.

In response to RES:MAN:HEAD? 1

Returns " , -1, 0, A, RMS, FIX, MAX, NA, 2006/12/01 10:00:00, 2006/12/01 10:00:10 .

Querying the Result (Cont'd)

RES:MAN:DATA / RES:AUTO:DATA

For TC measurement/PCC measurement (RES:MAN:DATA), the test data information of the specified memory number is returned.

For the program test (RES:AUTO:DATA), the test data information of the specified memory number and step number is returned.

Command **RESult:MANual:DATA?** <PROGRAM_NR1>
RESult:AUTO:DATA? <PROGRAM_NR1>, <STEP_NR1>

Parameter <PROGRAM_NR1>Memory number
 Value 1 to 50
 <STEP_NR1>Step number (program test only)
 Value 0 to 99

Response Returns the items below in order from the top in the comma-separated form.

Item	Response form	Response for the TC measurement and PCC measurement
Step number	NR1	-1
Operation mode	character	
Connection destination of the measurement terminal	character	
Polarity	character	
Single fault mode	character	
Test time	NR3	Value saved to the memory
Measured current	NR3*1	
Judgment for each step	character	
Test start date/time.	YYYY/MM/DD hh:mm:ss	
Test end date/time.	YYYY/MM/DD hh:mm:ss	

*1. If the maximum current is held, the maximum current is returned. Otherwise, the last current value is returned for a PASS judgment, or the setting (upper reference for U-FAIL, lower reference for L-FAIL, or +9.91E+37 for C-FAIL) is returned for a FAIL judgment.

Deleting the Test Results

RES:MAN:DEL / RES:AUTO:DEL

Deletes the contents of the specified memory number.

Command **RESult:MANual:DELeTe** <NR1>
RESult:AUTO:DELeTe <NR1>

Parameter Value: 1 to 50 Memory number

RES:MAN:DEL:ALL / RES:AUTO:DEL:ALL

Deletes the contents of all memories (specified test only).

Command **RESult:MANual:DELeTe:ALL**
RESult:AUTO:DELeTe:ALL

Setting the Program Test

To set a program, first select the program number using the PROG:NAME command. To execute the test, see “Executing the Test (Trigger Function)”.

PROG:NAME

Selects the program number.

Command **PROG:NAME <NR1>**
PROG:NAME?

Parameter	Value:	-1	Aborts the program operation (default) Set to TC Measurement Mode or PCC Measurement Mode.
		0 to 99	Program number

Response Returns the selected program number in the <NR1> form.

PROG:TITL

Sets the program name of the selected program.

The program name is 12 characters long. Spaces (0x20) will be automatically inserted if the name is less than 12 characters in length.

Command **PROG:TITLE "<string>"**
PROG:TITLE?

Parameter Value: Enter the program name. Double quotation, single quotation, comma, and “@” cannot be used. (The default name is “--UNTITLED--”.)

Response Returns the selected program number in the <string> form.

(Example) If “MY TEST1” is set
Returns "MY TEST1".

PROG:ADD

Sets the required number of steps for the selected program. The upper limit is 100 steps (500 steps total for all programs). You can query the upper limit that you can specify using PROG:COUN:FREE. The default values for the PROG:STEP:EDIT:LINE and PROG:STEP:EDIT:PAR commands are set in the added steps.

Command `PROG:ADD <NR1>`

Parameter Value: 1 to PROG:COUN:FREE? Required number of steps (up to 100 steps)

PROG:COUN

Queries the number of allocated steps of the selected program.

Command `PROG:COUN?`

Response Returns the number of allocated steps in the <NR1> form.

PROG:COUN:FREE

Queries the number of empty steps of the selected program.

Command `PROG:COUN:FREE?`

Response Returns the number of empty steps in the <NR1> form.

PROG:DEL

Deletes the all the allocated steps of the selected program.

Command `PROG:DELete`

PROG:MODE

Sets the current measurement mode of the selected program.

Command `PROG:MODE {RMS | DC | PEAK}`
`PROG:MODE?`

Parameter	Value:	RMS	Rms measurement (default)
		DC	DC measurement
		PEAK	Peak measurement

Response Returns the current measurement mode in the <character> form.

PROG:RANG:SEL

Sets the measurement range of the selected program.

Command `PROG:RANGe:SElect {AUTO | FIXed}`
`PROG:RANGe:SElect?`

Parameter	Value:	AUTO	Auto range switching (default)
		FIXed	Fixed range

See p. 82

For TC measurement, the range is determined by the upper reference, measurement network, and current measurement mode settings.

For PCC measurement, the range is determined by the upper reference and current measurement mode settings.

Response Returns the measurement range in the <character> form.

PROG:NETW

Sets the measurement network of the selected program.

Command **PROG:NETWork** "{A|B|B1|C|D|E|F|G}"
PROG:NETWork?

Parameter	Value:	"A"	(For IEC 60990) (1.5 kΩ // 0.22 μF) + 500 Ω (default)
		"B"	(For IEC 60990) (1.5 kΩ // 0.22 μF) + 500 Ω // (10 kΩ + 22 nF)
		"B1"*1	(For IEC 60065) (1.5 kΩ // 0.22 μF) + 500 Ω // (10 kΩ + 22 nF)
		"C"	(For IEC 60990) (1.5 kΩ // 0.22 μF) + 500 Ω // (10 kΩ + (20 kΩ + 6.2 nF) // 9.1 nF)
		"D"	1 kΩ
		"E"	1 kΩ // (10 kΩ + 11.225 nF + 579 Ω)
		"F"	1.5 kΩ // 0.15 μF
		"G"	2 kΩ

See p. 176

*1 Measures voltage U1 between the measurement network reference points.

Response Returns the measurement network in the <string> form.

SYST:CONF:LBR

Sets whether or not to supply power to the EUT during program test interval time.

Command **SYSTem:CONFigure:LBReak** {ON|OFF|1|0}
SYSTem:CONFigure:LBReak?

Parameter	Value:	ON (1)	Does not supply power to the EUT during the interval time (default)
		OFF (0)	Supplies power to the EUT during the interval time

Response Returns whether or not power is supplied to the EUT during the interval time. The value is returned in the <NR1> form.

PROG:FAB

Sets whether to continue the test if a FAIL judgment occurs during the program test.

Command **PROG:FABoort** {ON|OFF|1|0}
PROG:FABoort ?

Parameter	Value:	ON (1)	Abort the program test if a FAIL judgment occurs
		OFF (0)	Continue the program test even if a FAIL judgment occurs (default)

Response Returns whether the program test continues if a FAIL judgment occurs in the <NR1> form.

PROG:STEP:EDIT:LINE

Sets the step of the selected program.

Command `PROGRAM:STEP:EDIT:LINE <STEP_NR1>,<FUNC_character>,
<PROBE_character>,<POL_character>,<COND_character>,
<INTERV_numeric>
PROGRAM:STEP:EDIT:LINE? <STEP_NR1>`

Parameter <STEP_NR1>Step to be set

Value: 0 to 99

<FUNC_character>Operation mode

Value: TC TC Measurement Mode (default)
PCC PCC Measurement Mode

<PROBE_character>Connection destination of the measurement terminal

Value: ENCPE Between the enclosure and earth (default)
ENCENC Between two enclosures
ENCLIV Between the enclosure and power line (live)
ENCNEU Between the enclosure and power line (neutral)
NA When PCC Measurement Mode is selected

<POL_character>Power line polarity

Value: NORM Normal phase connection (default)
REV Reverse phase connection
NA When the connection destination of the measurement terminal is set
to between the enclosure and power line

<COND_character>Single fault mode

Value: NORM Normal condition (default)
FLTNEU Power line (neutral) disconnected condition
FLTPE Earth line disconnected condition (TC Measurement Mode only)
NA When the connection destination of the measurement terminal is set
to between the enclosure and power line

<INTERV_numeric>Interval time

Value: 1 to 99 If 99 is exceeded, 9.9E37 will be set.
The default value is 1.)
9.9E37 HOLD

Unit: S

Response Returns the operation mode, connection destination of the measurement terminal, power line polarity, single fault mode, and interval time in order in the comma-separated <FUNC_character>,<PROBE_character>,<POL_character>,<COND_character>,<INTERV_NR1> form.

PROG:STEP:EDIT:PAR

Sets the step parameters of the selected program.

Command `PROG:STEP:EDIT:PARAmeter <STEP_NR1>,<L_FAIL_numeric>,<L_FAIL_STAT_bool>,<U_FAIL_numeric>,<U_FAIL_STAT_bool>,<TIM_numeric>,<TIM_STAT_bool>,<WAIT_numeric>,<WAIT_STAT_bool>`
`PROG:STEP:EDIT:PARAmeter? <STEP_NR1>`

Parameter <STEP_NR1>Step to be set
 Value: 0 to 99

See p. 80

Parameter <L_FAIL_numeric>Lower reference
 Value: Varies depending on the current measurement mode and the measurement network settings.
 (The default value is 30 μ .)
 Unit: A

Parameter <L_FAIL_STAT_bool>Lower reference judgment
 Value: ON (1) Enable the judgment
 OFF (0) Disable the judgment (default)

Parameter <U_FAIL_numeric>Upper reference
 Value: Varies depending on the current measurement mode and the measurement network settings.
 (The default value is 15 m.)
 Unit: A

Parameter <U_FAIL_STAT_bool>Upper reference judgment
 Value: ON (1) Enable the judgment (default)
 OFF (0) Disable the judgment

Parameter <TIM_numeric>Test time, <WAIT_numeric>Test wait time
 Value: 1 to 999 The default value is 1.)
 Unit: S

Parameter <TIM_STAT_bool>Test time on/off
 Value: ON (1) Stop the test after the test time elapses (default)
 OFF (0) Not stop the test

Parameter <WAIT_STAT_bool>Test wait time on/off
 Value: ON (1) Start the test after the test wait time elapses
 OFF (0) Start the test immediately (default)

Response Returns the lower reference, lower reference judgment, upper reference, upper reference judgment, test time, test time on/off, test wait time, and test wait time on/off in order in the comma-separated <L_FAIL_NR3>,<L_FAIL_STAT_NR1>,<U_FAIL_NR3>,<U_FAIL_STAT_NR1>,<TIM_NR1>,<TIM_STAT_NR1>,<WAIT_NR1>,<WAIT_STAT_NR1> form.

Setting the Meter Mode Measurement

This section explains the meter mode measurement commands.

The commands with "CURR" in the second-level node are for current measurement. The commands with "VOLT" are for voltage measurement.

Setting the Measurement Network (Current Measurement Only)

CURR:NETW

*RST *RCL

Sets the measurement network (NTWK).

Command [SENSe:]CURRent:NETWork "{A|B|B1|C|D|E|F|G}"
[SENSe:]CURRent:NETWork?

Parameter	Value:	"A"	(For IEC 60990) (1.5 k Ω // 0.22 μ F) + 500 Ω (default)
		"B"	(For IEC 60990) (1.5 k Ω // 0.22 μ F) + 500 Ω // (10 k Ω + 22 nF)
		"B1"*1	(For IEC 60065) (1.5 k Ω // 0.22 μ F) + 500 Ω // (10 k Ω + 22 nF)
		"C"	(For IEC 60990) (1.5 k Ω // 0.22 μ F) + 500 Ω // (10 k Ω + (20 k Ω + 6.2 nF) // 9.1 nF)
		"D"	1 k Ω
		"E"	1 k Ω // (10 k Ω + 11.225 nF + 579 Ω)
		"F"	1.5 k Ω // 0.15 μ F
		"G"	2 k Ω

See p. 176

*1 Measures voltage U1 between the measurement network reference points.

Response Returns the measurement network in the <string> form.

Setting the Measurement Mode

CURR:MODE / VOLT:MODE

*RST *RCL

Sets the measurement mode (MODE).

Command [SENSe:]CURRent:MODE {RMS|DC|PEAK}
[SENSe:]CURRent:MODE?
[SENSe:]VOLTage:MODE {RMS|DC|PEAK}
[SENSe:]VOLTage:MODE?

Parameter	Value:	RMS	Rms measurement (default)
		DC	DC measurement
		PEAK	Peak measurement

Response Returns the current measurement mode in the <character> form.

Setting the Measurement Range (Current Measurement Only)

CURR:RANG:SEL

*RST

*RCL

 p. 73

Sets the measurement range (RANGE). The measurement range is determined by the measurement network and current measurement mode settings.

Command [SOURCE:]CURRENT:RANGE:SElect {AUTO|LOW|MEDIUM|HIGH}
[SOURCE:]CURRENT:RANGE:SElect?

Parameter	Value:	AUTO	Auto range switching (default)
		LOW	Range 1
		MEDIUM	Range 2
		HIGH	Range 3

Response Returns the measurement range in the <character> form.

Querying the Settings

CURR / VOLT

Queries the settings.

Command [SENSe:]CURRent?
[SENSe:]VOLTage?

Response Returns the measurement mode, measurement network, and measurement range in order in the <string> form in response to CURR? or VOLT?. NA is always returned for the measurement network and measurement range in response to VOLT?.

(Example) If measurement mode: RMS, measurement network: A, and measurement range: AUTO are specified

In response to CURR?

Returns "RMS,A,AUTO" .

In response to VOLT?

Returns "RMS,NA,NA" .

Querying the Measured Value

Queries the measured value. The READ query and MEASure query are the same. Some commands are invalid depending on the operation mode.

Querying the Measured Current Flowing through Measurement Terminals A and B

These queries are valid when the operation mode is current measurement, PCC measurement, TC measurement, and program test. These queries are valid only while the test is in progress for all modes other than current measurement.

READ:CURR:LEAK / MEAS:CURR:LEAK

Queries the measured current flowing through measurement terminals A and B.

Command `READ[:SCALar]:CURRent:LEAKage?`
`MEASure[:SCALar]:CURRent:LEAKage?`

Response Returns the measured current in the NR3 form.
Unit: A

READ:CURR:LEAK:MAX / MEAS:CURR:LEAK:MAX

Queries the maximum measured current that is being held.

Command `READ[:SCALar]:CURRent:LEAKage:MAXimum?`
`MEASure[:SCALar]:CURRent:LEAKage:MAXimum?`

Response Returns the maximum measured current that is held in the <NR3> form. The same value as READ:CURR:LEAK/MEAS:CURR:LEAK is returned during the test wait time.
Unit: A

Querying the Measured Voltage between the Measurement Network Reference Points

These queries are valid when the operation mode is set to current measurement (meter mode) and touch current measurement. In touch current measurement, these queries are valid only while a test is in progress.

READ:VOLT:UX / MEAS:VOLT:UX

See p. 176

Queries the measured voltage between the measurement network reference points.

Command **READ[:SCALAR]:VOLTage:UX?**
MEASure[:SCALAR]:VOLTage:UX?

Response Returns the measured voltage between reference points. The value is returned in the <NR3> form.

Unit: V

READ:VOLT:UX:MAX / MEAS:VOLT:UX:MAX

Queries the maximum measured voltage between reference points that is retained on the TOS3200. To clear the maximum measured voltage between reference points, send the CURR:MAX:CLE command.

Command **READ[:SCALAR]:VOLTage:UX:MAXimum?**
MEASure[:SCALAR]:VOLTage:UX:MAXimum?

Response Returns the maximum measured voltage between reference points that is retained on the TOS3200. The value is returned in the <NR3> form. This query returns the same value as READ:VOLT:UX/MEAS:VOLT:UX during the test wait time.

Unit: V

Querying the Measured Voltage between Measurement Terminals A and B (Voltage Measurement Only)

8

Remote Control

READ:VOLT:AB / MEAS:VOLT:AB

Queries the measured voltage between measurement terminals A and B.

Command **READ[:SCALAR]:VOLTage:AB?**
MEASure[:SCALAR]:VOLTage:AB?

Response Returns the measured voltage in the <NR3> form.

Unit: V

READ:VOLT:AB:MAX / MEAS:VOLT:AB:MAX

Queries the maximum measured voltage that is being held.

Command **READ[:SCALAR]:VOLTage:AB:MAXimum?**
MEASure[:SCALAR]:VOLTage:AB:MAXimum?

Response Returns the maximum measured voltage that is held in the <NR3> form.

Unit: V

Clearing the Maximum Measured Value

CURR:MAX:CLE

Clears the maximum measured voltage between the reference points and the maximum measured current that are held. These values are also cleared if you send the *RST or *RCL command.

Command [SENSe:]CURRent:MAXimum:CLEar

VOLT:MAX:CLE

Clears the maximum measured voltage between A and B that is held. This value is also cleared if you send the *RST or *RCL command.

Command [SENSe:]VOLTage:MAXimum:CLEar

Voltage, current, and power of the EUT

These queries are valid in all operation modes. If the test is not in progress, make the query after sending the OUTP:LINE ON command.

READ:CURR:LINE / MEAS:CURR:LINE

Queries the current of the EUT.

Command READ[:SCALar]:CURRent:LINE?
MEASure[:SCALar]:CURRent:LINE?

Response Returns the current of the EUT in the <NR3> form.
Unit: A

READ:VOLT:LINE / MEAS:VOLT:LINE

Queries the voltage of the EUT.

Command READ[:SCALar]:VOLTage:LINE?
MEASure[:SCALar]:VOLTage:LINE?

Response Returns the voltage of the EUT in the <NR3> form.
Unit: V

READ:POW:LINE / MEAS:POW:LINE

Queries the power of the EUT.

Command `READ[:SCALar]:POWer:LINE?`
`MEASure[:SCALar]:POWer:LINE?`

Response Returns the power of the EUT in the <NR3> form.
Unit: W

Various Settings

Holding the Maximum Measured Current

SYST:CONF:MMOD

Sets whether to hold the maximum measured current (MEAS MODE).

Command `SYSTem:CONFIgure:MMODE {NORMal|MAXimum}`
`SYSTem:CONFIgure:MMODE?`

Parameter	Value:	NORMal	Not hold (normal measurement) (default)
		MAXimum	Hold

Response Returns whether the maximum value is held in the <character> form.

Pass Judgment Hold Time

SYST:CONF:PHOL

Sets the time to hold the PASS judgment (PASS HOLD).

Command `SYSTem:CONFIgure:PHOLD {<numeric>|MIN|MAX}`
`SYSTem:CONFIgure:PHOLD? {MIN|MAX}`

Parameter	Value:	0.2 to 10.0	If 10.0 is exceeded, 9.9E37 will be set. (The default value is 2.)
		9.9E37	HOLD
Unit:		S	

Response Returns the time the PASS judgment is held in the <NR3> form.

Converting Measured Current Based on the Specified Line Voltage

SYST:CONF:CONV

Sets the supply voltage used to convert to current (CONV).

Command `SYSTem:CONFIgure:CONVersion {<numeric>|MIN|MAX}`
`SYSTem:CONFIgure:CONVersion? {MIN|MAX}`

Parameter Value: 0 Not convert the current (default)
80.0 to 300.0
Unit: V

Response Returns the supply voltage in the <NR3> form.

Setting the Safety Extra Low Voltage (SELV)

SYST:CONF:SELV

Sets the safety extra low voltage (SELV).

Command **SYSTem:CONFigure:SELV** {<numeric>|MIN|MAX}
SYSTem:CONFigure:SELV? {MIN|MAX}

Parameter Value: 0 Disable the SELV function (default)
10 to 99
Unit: V

Response

Response Returns the safety extra low voltage in the <NR3> form.

Setting the Buzzer Volume

SYST:BEEP:VOL:PASS

Sets the volume of the buzzer that sounds when the judgment is PASS.

Command **SYSTem:BEEPer:VOLume:PASS** {<numeric>|MIN|MAX}
SYSTem:BEEPer:VOLume:PASS? {MIN|MAX}

Parameter Value: 0 to 10 (default: 3)

Response Returns the buzzer volume for PASS judgments in the <NR3> form.

SYST:BEEP:VOL:FAIL

Sets the volume of the buzzer that sounds when the judgment is FAIL.

Command **SYSTem:BEEPer:VOLume:FAIL** {<numeric>|MIN|MAX}
SYSTem:BEEPer:VOLume:FAIL? {MIN|MAX}

Parameter Value: 0 to 10 (default: 3)

Response Returns the buzzer volume for FAIL judgments in the <NR3> form.

Setting the Screen Brightness

DISP:CONT

Sets the screen brightness.

Command `DISPlay:CONTRast {<numeric>|MIN|MAX}`
`DISPlay:CONTRast? {MIN|MAX}`

Parameter Value: 0 to 10 (default: 5)

Response Returns the screen brightness in the <NR3> form.

Setting the Time

SYST:DATE

Sets the date.

Command `SYSTem:DATE <YEAR_NR1>,<MONTH_NR1>,<DAY_NR1>`
`SYSTem:DATE?`

Parameter <YEAR_NR1> Year
Value: 2000 to 2099

<MONTH_NR1> Month
Value: 1 to 12

<DAY_NR1> Day
Value: 1 to 31

Response Returns the year, month, and day in order in the <NR1>,<NR1>,<NR1> form.

SYST:TIME

Sets the time.

Command `SYSTem:TIME <HOUR_NR1>,<MIN_NR1>,<SEC_NR1>`
`SYSTem:TIME?`

Parameter <HOUR_NR1> Hour
Value: 0 to 23

<MIN_NR1> Minute, <SEC_NR1>Second
Value: 0 to 59

Response Returns the hour, minute, and second in order in the <NR1>,<NR1>,<NR1> form.

Turning the Power Line to the EUT On/Off

OUTP:LINE

*RST *RCL

Turns the power line to the EUT on/off. You will not be able to start the test if the power line is on.

Command `OUTPut:LINE[:STATe] {ON|OFF|1|0}`
`OUTPut:LINE[:STATe]?`

Parameter	Value:	ON (1)	Power line on
		OFF (0)	Power line off (default)

Response Returns the power line on/off setting in the <NR1> form.

Showing/Hiding Communication Errors

SYST:CONF:TRAC

Shows or hides the communication error numbers.

Command `SYSTem:CONFigure:TRACe {ON|OFF|1|0}`
`SYSTem:CONFigure:TRACe?`

Parameter	Value:	ON (1)	Communication error trace function on
		OFF (0)	Communication error trace function off (default)

Response Returns the on/off setting of the communication error trace function in the <NR1> form.

Releasing the Protection Status

SYST:PROT:CLE

 p. 204

Releases the protection status.

Command `SYSTem:PROTEction:CLEar`

Other Settings

SYST:ERR

Queries the oldest error information or event information from the error queue. The error queue can store up to 255 errors.

The error queue is cleared completely using the *CLS command.

Command `SYSTem:ERRor [:NEXT] ?`

Response Returns the oldest error or event information in the error/event queue in response to SYST:ERR? as follows:

(Example) If there is no error or event

Returns 0, "No error".

(Example) If a command that cannot be executed in the present operating condition is received

Returns -221, "Settings conflict".

If multiple errors are present, errors are returned in order from the oldest error. The returned errors are cleared.

SYST:KLOC

Sets or releases the panel operation lock.

Command `SYSTem:KLOCK {ON|OFF|1|0}`
`SYSTem:KLOCK?`

Parameter	Value:	ON (1)	Lock the panel operation
		OFF (0)	Release the panel operation lock (default)

Response Returns the panel operation lock setting in the NR1 form.

SYST:LOC (RS232C and USB only)

Sets the TOS3200 operation to local mode (panel operation). This is a substitute command for the IEEE488.1 REN message (Remote Disable).

SYST:REM or SYST:RWL is used to return to remote mode.

Command `SYSTem:LOCa1`

SYST:OPT

Queries the option (HP21-TOS only) that is installed in the TOS3200. The operation is the same as *OPT?.

Command `SYSTem:OPTion?`

Response If the HP21-TOS is installed, "HP21-TOS" is returned. Returns 0 if the option is not installed.

SYST:REM (RS232C and USB only)

Sets the TOS3200 operation to remote mode. All panel keys except the LOCAL key and STOP switch are locked. This is a substitute command for the IEEE488.1 REN message (Remote Enable) and address designation.

SYST:LOC is used to return to local mode.

Command `SYSTem:REMOte`

SYST:RWL (RS232C and USB only)

Sets the TOS3200 operation to remote mode. All panel keys except the STOP switch are locked (LOCAL key is also locked). This is a substitute command for the IEEE488.1 llo message (Local Lock Out).

SYST:LOC is used to return to local mode.

Command `SYSTem:RWLock`

SYST:VERS

Queries the version of the SCPI specifications to which the TOS3200 conforms.

Command `SYSTem:VERSion?`

Response Always returns 1999.0 in response to SYST:VERS?.

Status Register and Status Report Function

IEEE488.2 and SCPI registers are used for the status reports.

In each SCPI status register, there are sub registers, CONDition register, EVENT register, ENABle register, PTRansition filter, and NTRansition filter.

Fig. 8-4 shows the SCPI status register structure. The character “+” represents the the logical OR of the register bits.

CONDition register

The CONDition register transmits automatically and reflects the condition of the TOS3200 in real-time. Reading this register does not affect the contents.

EVENT register

The EVENT register bits are automatically set according to the changes in the CONDition register. The rule varies depending on the positive and negative transition filters (PTRansition and NTRansition). The EVENT register is reset when it is read.

ENABle register

The ENABle register enables the reports to the summary bit or status bit of the event bit.

Transition filter

Use the PTRansition (positive transition) filter to report events when the condition changes from false to true.

Use the NTRansition (negative transition) filter to report events when the condition changes from true to false.

If both the positive filter and the negative filter are set to true, events can be reported each time the status changes.

If both filters are cleared, event reporting will be disabled.

1999 SCPI Syntax & Style

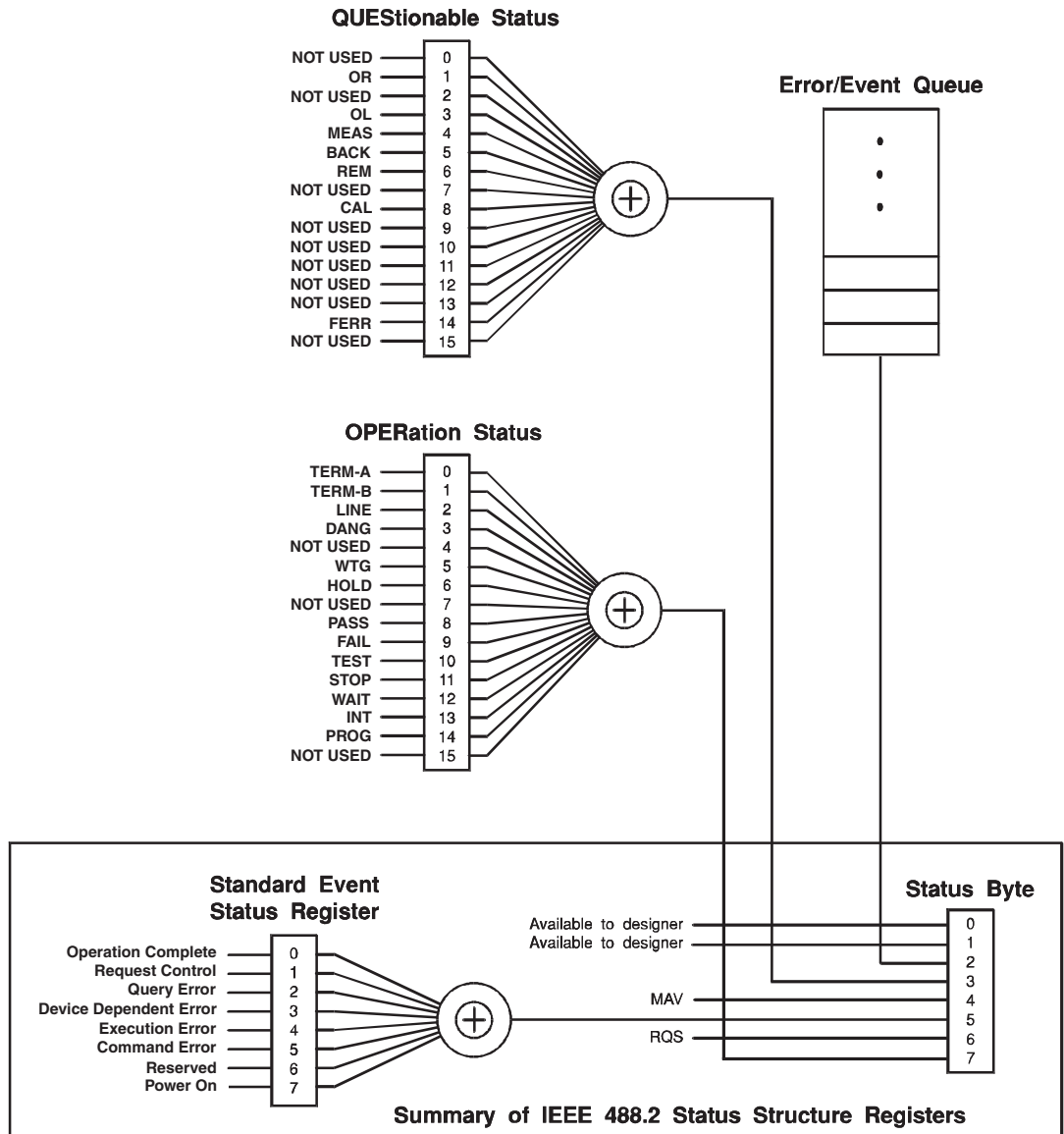

Partially changed SCPI Standard 1999.0 Volume1 fig.9-1.

Fig. 8-4 Status register

IEEE488.2 Register Model

Status Byte Register

The status byte register stores STB and RQS (MSS) messages as defined by the IEEE488.1 standard. The status byte register can be read using IEEE488.1 serial polling or IEEE488.2 common command *STB?.

When serial polling is carried out, bit 6 responds with the request service (RQS). The status byte value is not changed by serial polling.

*STB? makes the device transmit the contents of the status byte register and the master status summary (MSS) message.

*STB? does not change the status byte, MSS, and RQS.

Bit	Decimal value	Bit name	Description
0	1	Reserved	Reserved for future use by the IEEE488. The bit value is notified as zero.
1	2	Reserved	
2	4	Error/Event Queue	If data exists in the error or event queue, this bit will be set to true.
3	8	Questionable Status Register (QUES)	This bit is set to true when a bit is set in the QUESTIONable event status register and the corresponding bit in the QUESTIONable status enable register is true.
4	16	Message Available (MAV)	This bit is set to true when a request is received from the digital programming interface and the TOS3200 is ready to output the data byte.
5	32	Standard Event Status Bit Summary (ESB)	This bit is set to true when a bit is set in the event status register.
6	64	Request Service (RQS) Master Status Summary (MSS)	This bit is set to true when a bit is set in the service request enable register, and the corresponding bit exists in the status byte. The SRQ line of the GPIB is set. This bit is set to true when any of the bits in the status byte register is set to 1 and the corresponding bit in the service request enable register is set to 1.
7	128	Operation Status Register (OPER)	This bit is set to true when a bit is set in the OPERATION event status register and the corresponding bit in the OPERATION status enable register is set.
8-15	–	NOT USED	–

Event Status Register

The event status register bits are set when certain events occur during operation. All bits of the event status register are set by the error event queue.

The register is defined by the IEEE488.2 standard and is controlled by the IEEE488.2 common commands *ESE, *ESE?, and *ESR?.

Bit	Decimal value	Bit name	Description
0	1	Operation Complete (OPC)	Set when an *OPC command is received and all operations in standby are complete.
1	2	Request Control (RQC)	Not used.
2	4	Query Error (QYE)	Set when an attempt is made to read data from the output queue when there is no output or the error queue is in wait status. Indicates that there is no data in the error queue.
3	8	Device Dependent Error (DDE)	Set when there is a device-specific error.
4	16	Execution Error (EXE)	Set when the TOS3200 evaluates the program data following the header is outside the formal input range or does not match the performance of the TOS3200. This indicates that a valid SCPI command may not be executed correctly depending on the conditions of the TOS3200.
5	32	Command Error (CME)	Set when an IEEE 488.2 syntax error is detected, when an unidentifiable header is received, or when a group execution trigger enters the internal IEEE 488.2 SCPI command input buffer.
6	64	User Request (URQ)	Not used.
7	128	Power ON (PON)	Set when the power is turned on.
8-15	–	Reserved	–

SCPI Register Model

OPERation Status Register

The OPERation status register is a 16-bit register which contains information about conditions which are part of the TOS3200 normal operation.

Bit	Decimal value	Bit name	Description
0	1	Terminal [A] is active	Terminal A is active.
1	2	Terminal [B] is active	Terminal B is active.
2	4	EUT LINE is active	The power line of the EUT is active.
3	8	DANGer (AB voltage is exceeding SELV voltage)	The voltage between terminals A and B exceeds the SELV voltage while the test is in progress.
4	16	NOT USED	–
5	32	Waiting for TRIGger	The TOS3200 is waiting for a trigger.
6	64	Test is under HOLD state	Hold state
7	128	NOT USED	–
8	256	Test PASSed	Pass judgment
9	512	Test FAILed	Fail judgment
10	1024	TEST running	Test in progress
11	2048	STOP key is being pressed	The STOP switch is pressed.
12	4096	Test is under WAIT state	Test wait time status
13	8192	Test is under INTerval state	Interval state
14	16384	Auto PROGRAM test running	Program test is in progress.
15	32768	NOT USED	–

STAT:OPER

Queries the event of the OPERation status register.
A query clears the contents of the register.

Command `STATus:OPERation[:EVENT]?`

Response Returns the event of the OPERation status register in the <NR1> form.

STAT:OPER:COND

Queries the condition of the OPERation status register.
A query does not clear the contents of the register.

Command `STATus:OPERation:CONDition?`

Response Returns the condition of the OPERation status register in the <NR1> form.

STAT:OPER:ENAB

Sets the enable register of the OPERATION status register.

Command `STATus:OPERation:ENABle <NRf>`
`STATus:OPERation:ENABle?`

Parameter Value: 0 to 32767

Response Returns the enable register of the OPERATION status register in the <NR1> form.

STAT:OPER:PTR

Sets the positive transition of the OPERATION status register.

Command `STATus:OPERation:PTRansition <NRf>`
`STATus:OPERation:PTRansition?`

Parameter Value: 0 to 32767

Response Returns the positive transition of the OPERATION status register in the <NR1> form.

STAT:OPER:NTR

Sets the negative transition of the OPERATION status register.

Command `STATus:OPERation:NTRansition <NRf>`
`STATus:OPERation:NTRansition?`

Parameter Value: 0 to 32767

Response Returns the negative transition of the OPERATION status register in the <NR1> form.

QUESTionable Status Register

The QUESTionable status register is a 16-bit register that stores information related to the questionable events and status during TOS3200 operation.

These register bits may indicate problems with the measured data of the TOS3200.

Bit	Decimal value	Bit name	Description
0	1	NOT USED	–
1	2	Over Range	Measurement range exceeded
2	4	NOT USED	–
3	8	Overload	Overload protection
4	16	MEASure check failed	Measurement check error
5	32	BACKup data broken	Backup data error
6	64	REMOte	Change in the enable signal
7	128	NOT USED	–
8	256	CALibration out-of-date	Calibration date expired
9	512	NOT USED	–
10	1024	NOT USED	–
11	2048	NOT USED	–
12	4096	NOT USED	–
13	8192	NOT USED	–
14	16384	Fatal ERRor	Send the *TST command to check ^{*1}
15	32768	NOT USED	–

*1. If the response to the *TST command is not zero, use the SYST:ERR command to check the error details.

STAT:QUES

Queries the event of the QUESTionable status register.

A query clears the contents of the register.

Command `STATus:QUESTionable[:EVENT]?`

Response Returns the event of the QUESTionable status register in the <NR1> form.

STAT:QUES:COND

Queries the condition of the QUESTionable status register.

A query does not clear the contents of the register.

Command `STATus:QUESTionable:CONDition?`

Response Returns the condition of the QUESTionable status register in the <NR1> form.

STAT:QUES:ENAB

Sets the enable register of the QUEStionable status register.

Command `STATus:QUEStionable:ENABle <NRf>`
`STATus:QUEStionable:ENABle?`

Parameter Value: 0 to 32767

Response Returns the enable register of the QUEStionable status register in the <NR1> form.

STAT:QUES:PTR

Sets the positive transition of the QUEStionable status register.

Command `STATus:QUEStionable:PTRansition <NRf>`
`STATus:QUEStionable:PTRansition?`

Parameter Value: 0 to 32767

Response Returns the positive transition of the QUEStionable status register in the <NR1> form.

STAT:QUES:NTR

Sets the negative transition of the QUEStionable status register.

Command `STATus:QUEStionable:NTRansition <NRf>`
`STATus:QUEStionable:NTRansition?`

Parameter Value: 0 to 32767

Response Returns the negative transition of the QUEStionable status register in the <NR1> form.

Preset Status

STAT:PRES

Resets the ENABLE, PTRansition, NTRansition filter registers of all status registers (including sub registers) to their default values.

Default values:

STATus:ENABle = 0x0000

STATus:PTRansition = 0x7FFF

STATus:NTRansition = 0x0000

Command `STATus:PRESet`

TC Measurement/PCC Measurement (MANUAL TEST)

Explanation is given using a TC measurement as an example. All commands are common with the PCC measurement except the setup commands.

First, set the TC measurement. The root node, [:SOUR], can be omitted. For a PCC measurement, replace "TC" of the second node to "PCC".

```
FUNC "TC"  
TC:PROB ENCPE;POL NORM;COND FLTNEU  
TC:LIM:LOW:LEV 30UA;STAT 1  
TC:LIM:UPP:LEV 30M;STAT 1  
TC:TIM:TIME 1;STAT 1  
TC:WAIT:TIME 1;STAT 1  
TC:NETW "A";MODE RMS  
TC:RANG:SEL AUTO
```

The specified settings can be queried collectively.

```
TC?
```

To save the maximum measured current when saving test results

```
SYST:CONF:MMOD MAX
```

After you specify the settings, start the test (when performing the test without using the trigger).

You cannot start the test while the memory is being recalled/saved, when the power line of the EUT is on, when the TOS3200 is in the protection status, and when PASS/FAIL judgment is in progress.

```
TRIG:SOUR IMM  
INIT
```

When you send INIT, the test starts. While the test is in progress, you can query the measured current, measured voltage between the reference points (only for touch current measurement), EUT current, EUT voltage, EUT power, and the test execution status.

```
MEAS:CURR:LEAK?  
MEAS:CURR:LEAK:MAX?  
MEAS:VOLT:UX?  
MEAS:VOLT:UX:MAX?  
MEAS:CURR:LINE?  
MEAS:VOLT:LINE?  
MEAS:POW:LINE?  
TC:EXEC?
```

To switch the display during a test to expanded numeric display mode.

```
DISP:SIZE
```

To display the measured voltage between the reference points in the expanded numeric display (only for touch current measurement)

```
DISP:UXV
```

The test stops after the test time elapses, when U-FAIL judgment occurs, or when you press the STOP switch. After the test stops, query the test result.

```
RES?
```

You can save the test result.

```
RES:MAN:SAVE 1
```

Query the saved result.

```
RES:MAN:HEAD? 1
RES:MAN:DATA? 1
```

Program Test (AUTO TEST)

Set the program number and program name. If you set the program number, the operation mode will switch automatically to AUTO.

```
PROG:NAME 1;TITL "MY TEST1"
```

The current measurement mode, measurement range, measurement network, and whether to continue the test if a FAIL judgment occurs during the program test are common to the program. They cannot be set separately for each step.

```
PROG:MODE RMS;NETW "B";FAB 0
PROG:RANG:SEL AUTO
```

Set the required number of steps to the program. If a step is added, it is added to the last specified step. Default values are set to the step. The default settings are different between the MANUAL TEST and AUTO TEST.

```
PROG:ADD 2
```

You can perform various tasks such as check the number of steps or the number of steps that you can set and delete all the steps. You cannot insert a step between two steps that are already set or delete a specific step.

```
PROG:COUN?
PROG:COUN:FREE?
PROG:DEL
```

The PROG:STEP:EDIT:LINE and PROG:STEP:EDIT:PAR commands are available for setting the steps. PROG:STEP:EDIT:LINE is used to set the operation mode of the step, connection destination of the measurement terminal, power line polarity, single fault mode, and interval time.

```
PROG:STEP:EDIT:LINE 0,TC,ENCPE,NORM,NORM,100
PROG:STEP:EDIT:LINE 1,PCC,NA,NORM,NORM,1
```

Because the interval time range is 1 to 99, the interval time of step 1 is set to HOLD (+9.9E+37).

PROG:STEP:EDIT:PAR is used to set the lower reference, lower reference judgment on/off, upper reference, upper reference judgment on/off, test time, test time on/off, test wait time, and test wait time on/off.

```
PROG:STEP:EDIT:PAR 0,35UA,1,0.5MA,1,1S,1,1S,0
PROG:STEP:EDIT:PAR 1,40UA,0,1MA,1,1S,1,1S,0
```

To set the test result current to the maximum measured current

```
SYST:CONF:MMOD MAX
```

To shut off the power supply to the EUT during the interval time

```
SYST:CONF:LBR ON
```

After you specify the settings, start the test (when performing the test without using the trigger).

You cannot start the test while the memory is being recalled/saved, when the power line of the EUT is on, when the TOS3200 is in the protection status, and when PASS/FAIL judgment is in progress.

```
TRIG:SOUR IMM
INIT
```

When you send INIT, the test starts. While the test is in progress, you can query the measured current, EUT current, EUT voltage, EUT power, and the test execution status.

```
MEAS:CURR:LEAK?  
MEAS:CURR:LEAK:MAX?  
MEAS:CURR:LINE?  
MEAS:VOLT:LINE?  
MEAS:POW:LINE?  
PROG:EXEC?
```

In step 1, the interval time is set to HOLD. If you send the following command during the hold status or while waiting for the interval time to elapse, the program will proceed to the next step.

```
TRIG:HREL
```

The test stops after all the steps are completed (PASS), when a FAIL judgment occurs, or when you press the STOP switch. After the test stops, query the test result (total judgment).

```
RES?
```

You can save the test result.

```
RES:AUTO:SAVE 1
```

Query the saved result.

```
RES:AUTO:HEAD? 1  
RES:AUTO:DATA? 1,0  
RES:AUTO:DATA? 1,1
```

Meter Mode Measurement

For a current measurement, query the measured value using the MEAS/READ command after setup.

```
FUNC "CURR"  
CURR:NETW "A";MODE RMS  
CURR:RANG:SEL AUTO  
MEAS:CURR:LEAK?  
MEAS:CURR:LEAK:MAX?
```

For a voltage measurement, query the measured value using the MEAS/READ command after setup.

```
FUNC "VOLT"  
VOLT:MODE RMS  
MEAS:VOLT:AB?  
MEAS:VOLT:AB:MAX?
```



Maintenance

This chapter covers daily maintenance such as measurement check, how to set the system clock, how to manage periodic calibration, and how to replace the fuse and battery.

Test Lead Check

Test leads are consumables. Periodically check for tears or breaks in the covering.



Tears or breaks in the covering can lead to electric shock or fire. If a tear or break is found, stop using it immediately.

To purchase accessories or options, contact your Kikusui agent or distributor.

Measurement Check

This function checks the current measurement circuit by running a small current between measurement terminals A and B. Because this test is performed by shorting two test leads, it also checks breaks in the test leads. Use this function as a preliminary inspection before using the TOS3200.

- 1 Attach an alligator clip to the test leads and connect them to the measurement terminals.**
- 2 Short the two test leads.**

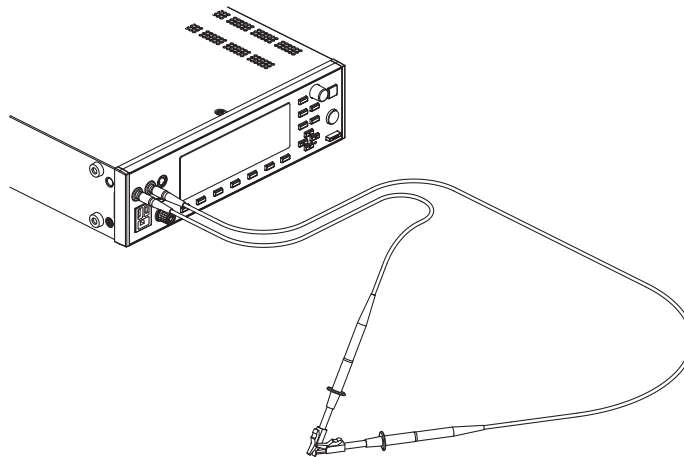
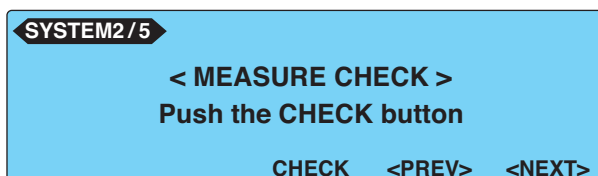
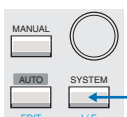

Fig. 9-1 Measurement check connection

- 3 Press the SYSTEM key to display SYSTEM1/5, and press the <NEXT> (F5) key to display SYSTEM2/5.**



- 4 Press the CHECK (F3) key.**

If the result of the measurement check is OK

The message "Check OK!" will appear. Press the MANUAL or AUTO key and set the test conditions to be executed.

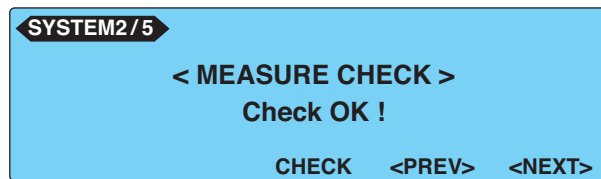

If the result of the measurement check is NG

The messages "MEASURE PROTECTION" and "Check NG!" will appear, and the TOS3200 will enter the protection status. Press the STOP switch to release the protection status, and return to step 3.

If the result is NG even when you perform the measurement check again, check whether the probe is broken. If the probe is not broken, the TOS3200 needs to be repaired. For repairs, contact your Kikusui agent or distributor.

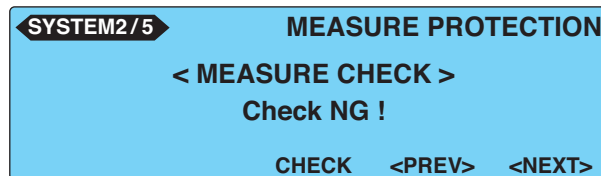

Time Settings and Calibration Management

The TOS3200 manages the calibration date using the internal system clock. If the preset calibration date is due, the message "CAL DATE EXPIRED" will appear on the screen when the power is turned on.

CAL DATE EXPIRED

Time information will be added to the stored data when you store the test data. If the system clock is not correct, synchronize it to the present time.

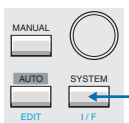

1 Press the **SYSTEM** key to display **SYSTEM1/5**.

2 Press the **<NEXT> (F5)** key four times to display **SYSTEM5/5**.

Use the function key or arrow keys to move the underscore to the item you want to change, and use the rotary knob to set the value.

```
SYSTEM5/5
TIME ADJUST :2006/10/18 16:26
CAL. DATE   :2006/10/07
ALARM       :2007/10/18
CAL.PROTECT :ON
ADJUST      ALARM <PREV>
```

The factory default settings are shown below.

TIME ADJUST (system clock):	Standard Japanese time at factory shipment.
CAL. DATE (calibration date):	Calibration date at factory shipment.
ALARM (calibration due date):	One year after CAL. DATE.
CAL. PROTECT (calibration due protection):	OFF (disable protection).

TIME ADJUST (system clock)

Set the present time in the following format: year/month/day hour:minute. The time that appears is the time when SYSTEM5/5 is displayed.

NOTE

Enter the present time, and press the ADJUST (F1) key to apply the entered time.

CAL. DATE (calibration date)

The date is set at the factory or by an authorized service center of Kikusui when calibration is performed. The date is set in the following format: year/month/day. (The user cannot set this date).

ALARM (calibration due date)

Set the calibration due date in the following format: year/month/day.

CAL. PROTECT (calibration due protection)

Sets the action taken when the calibration date expires.

If CAL. PROTECT is turned ON, the TOS3200 will display the blinking message “CAL DATE EXPIRED” to notify that the calibration date is due. You cannot use the TOS3200 in this condition.

Press the STOP switch to display SYSTEM5/5, and turn CAL. PROTECT off to continue using the TOS3200.

If the calibration date is due and CAL. PROTECT is turned off, the message “CAL DATE EXPIRED” will appear at power-on. You can continue using the TOS3200 by pressing the STOP switch.

Calibration



The TOS3200 is shipped after carrying out appropriate calibrations. We recommend periodic calibration to maintain the performance over an extended period.

To achieve periodic calibration, set an appropriate calibration due date (ALARM). For calibration, contact your Kikusui agent or distributor.

Replacing the Fuse

A protection fuse is inserted in the power line to the EUT. Normally, the protection function is activated if 1500 VA or 15.75 A is exceeded, and the power line to the EUT will be cut off. Therefore, this fuse will not blow with normal operation. However, if this fuse blows due to errors in the wiring or aging, it can be replaced.



Possible electric shock.

- Remove the power cord from the AC inlet for the EUT before replacing the fuse.
- Use a fuse of shape, rating, and characteristics that conform to the TOS3200. Using a fuse of a different rating or shorting the fuse holder is dangerous.

- 1** Remove the fuse holder on the rear panel by pushing the fuse holder and turning it counterclockwise using a flat-blade screwdriver
- 2** Replace with an appropriate fuse.
- 3** Attach the fuse holder by pressing the fuse holder and turning it to the right.

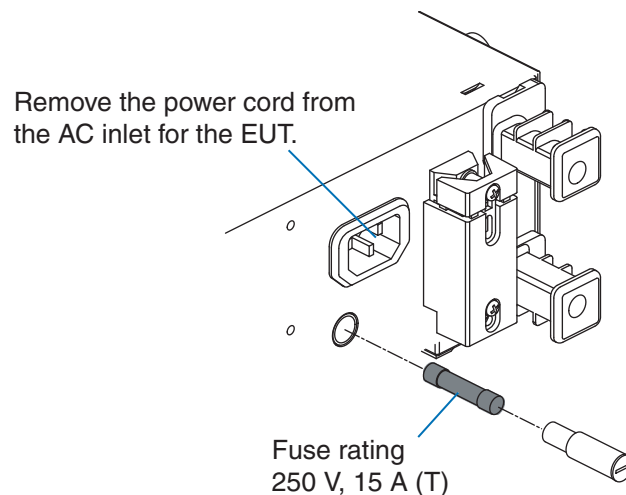

Fig. 9-2 Fuse replacement

Replacing the Backup Battery

The TOS3200 uses a lithium battery for memory backup.

If the battery power falls low, you will not be able to store measurement conditions and other settings. (The battery life varies depending on the usage environment.) We recommend that you change it once every three years along with the internal inspection and cleaning.

The cover must be opened to replace the backup battery. For replacement, contact your Kikusui agent or distributor.

This product comes with an installed CR Coin Lithium Battery which contains Perchlorate Material. Disposal of this battery may be regulated due to environmental considerations.

See www.dtsc.ca.gov/hazardouswaste/perchlorate



Specifications

This chapter gives the specifications and external dimensions.

Unless specified otherwise, the specifications are for the following settings and conditions.

- The warm-up time is 30 minutes.
- rdng: Indicates the read value.
- EUT: Denotes the equipment under test.

Measurement Items, Measurement Mode, and Measurement Network

Measurement item	TC		TC measurement
	Measurement method		Uses a measurement network representing the human body impedance, measures the voltage drop across the reference resistance, and calculates the TC.
	PROBE setting	ENCPE	Measurement terminal A: Measurement terminal (for connecting to the EUT enclosure) Measurement terminal B: Open
		ENCENC	Measurement terminal A and B: Measurement terminals (for connecting to the EUT enclosure)
		ENCLIV, ENCNEU	Measurement terminal A: Measurement terminal (for connecting to the EUT enclosure) Measurement terminal B: Open
	PCC		Protective conductor current measurement
	Measurement method		Measures the voltage drop across a reference resistance that is inserted in the middle of the protective earth wire and measure the PCC.
METER		Measures the current flowing through measurement terminals A and B or the applied voltage (cannot be measured simultaneously).	
Measurement method	Current measurement	Uses a measurement network representing the human body impedance, measures the voltage drop across the reference resistance, and calculates the current flowing through terminals A and B.	
	Voltage measurement	Measures the voltage applied between measurement terminals A and B.	
Measurement mode (MODE)	DC		Measures only the DC component by eliminating the AC component.
	RMS		Measures the true rms value.
	PEAK		Measures the waveform peak value.
Measurement network (NTWK) See p. 176	Network A (IEC 60990 compliant)		Basic measurement element: $(1.5 \text{ k}\Omega // 0.22 \text{ }\mu\text{F}) + 500 \text{ }\Omega$
	Network B (IEC 60990 compliant)		Basic measurement element: $(1.5 \text{ k}\Omega // 0.22 \text{ }\mu\text{F}) + 500 \text{ }\Omega // (10 \text{ k}\Omega + 22 \text{ nF})$
	Network B1 (IEC 60990 compliant)		
	Network C (IEC 60990 compliant)		Basic measurement element: $(1.5 \text{ k}\Omega // 0.22 \text{ }\mu\text{F}) + 500 \text{ }\Omega // (10 \text{ k}\Omega + (20 \text{ k}\Omega + 6.2 \text{ nF}) // 9.1 \text{ nF})$
	Network D		Basic measurement element: $1 \text{ k}\Omega$
	Network E		Basic measurement element: $1 \text{ k}\Omega // (10 \text{ k}\Omega + 11.225 \text{ nF} + 579 \text{ }\Omega)$
	Network F		Basic measurement element: $1.5 \text{ k}\Omega // 0.15 \text{ }\mu\text{F}$
	Network G		Basic measurement element: $2 \text{ k}\Omega$
Network constant tolerance		Resistor: $\pm 0.1 \%$, capacitor $0.15 \text{ }\mu\text{F}$: $\pm 2 \%$, others: $\pm 1 \%$	

Current Measurement Section*1

Display/ resolution i: measurement current	$i < 1 \text{ mA}$	$\square\square\square \text{ }\mu\text{A} / 1 \text{ }\mu\text{A}$
	$1 \text{ mA} \leq i < 10 \text{ mA}$	$\square.\square\square \text{ mA} / 0.01 \text{ mA}$
	$10 \text{ mA} \leq i < 100 \text{ mA}$	$\square\square.\square \text{ mA} / 0.1 \text{ mA}$

Measurement range	RANGE1	PCC		DC, RMS: 30 μ A to 600 μ A, PEAK: 50 μ A to 850 μ A
		Network A, B, B1, and C		
		Network D and E		DC, RMS: 30 μ A to 300 μ A, PEAK: 50 μ A to 424 μ A
		Network F		DC, RMS: 30 μ A to 200 μ A, PEAK: 50 μ A to 282 μ A
		Network G		DC, RMS: 30 μ A to 150 μ A, PEAK: 50 μ A to 212 μ A
	RANGE2	PCC		DC, RMS: 500 μ A to 6.00 mA, PEAK: 700 μ A to 8.50 mA
		Network A, B, B1, and C		
		Network D and E		DC, RMS: 250 μ A to 3.00 mA, PEAK: 350 μ A to 4.24 mA
		Network F		DC, RMS: 166 μ A to 2.00 mA, PEAK: 233 μ A to 2.82 mA
		Network G		DC, RMS: 125 μ A to 1.50 mA, PEAK: 175 μ A to 2.12 mA
	RANGE3	PCC		DC, RMS: 5.00 mA to 30.0 mA, PEAK: 7.00 mA to 90.0 mA
		Network A, B, B1, and C		
		Network D and E		DC, RMS: 2.50 mA to 30.0 mA, PEAK: 3.50 mA to 45.0 mA
		Network F		DC, RMS: 1.66 mA to 20.0 mA, PEAK: 2.33 mA to 30.0 mA
		Network G		DC, RMS: 1.25 mA to 15.0 mA, PEAK: 1.75 mA to 22.5 mA
	Range switching		AUTO or FIX selectable. If the measured value exceeds the measurement range of each range, the measured value will blink to warn the user.	
			AUTO	Automatically selects the range according to the measured value.
		FIX	Automatically sets the range according to the upper reference setting in TC and PCC measurements. Fixed to an arbitrary range in METER measurement.	
Measurement accuracy ^{*2}	RANGE1	DC		\pm (5.0 % of rdng + 20 μ A)
		RMS ^{*3}	15 Hz \leq f \leq 10 kHz	\pm (2.0 % of rdng + 8 μ A)
			10 kHz < f \leq 1 MHz	\pm (5.0 % of rdng + 10 μ A)
		PEAK	15 Hz \leq f \leq 1 kHz	\pm (5.0 % of rdng + 10 μ A)
	1 kHz < f \leq 10 kHz		\pm (5.0 % of rdng + 10 μ A)	
	RANGE2	DC		\pm (5.0 % of rdng + 50 μ A)
		RMS ^{*3}	15 Hz \leq f \leq 10 kHz	\pm (2.0 % of rdng + 20 μ A)
			10 kHz < f \leq 1 MHz	\pm (5.0 % of rdng + 20 μ A)
		PEAK	15 Hz \leq f \leq 1 kHz	\pm (2.0 % of rdng + 50 μ A)
	1 kHz < f \leq 10 kHz		\pm (5.0 % of rdng + 50 μ A)	
	RANGE3	DC		\pm (5.0 % of rdng + 0.5 mA)
		RMS ^{*3}	15 Hz \leq f \leq 10 kHz	\pm (2.0 % of rdng + 0.2 mA)
			10 kHz < f \leq 1 MHz	\pm (5.0 % of rdng + 0.2 mA)
PEAK		15 Hz \leq f \leq 1 kHz	\pm (2.0 % of rdng + 0.5 mA)	
	1 kHz < f \leq 10 kHz	\pm (5.0 % of rdng + 0.5 mA)		
Input resistance		1 M Ω \pm 1 %		
Input capacitance		< 200 pF		
Common mode rejection ratio		\leq 10 kHz: 60 dB or more. 10 kHz to 1 MHz: 40 dB or more		

*1 The current measurement may not be stable due to effects such as the power line waveform, and the wiring between the TOS3200 and EUT particularly if the measurement mode is set to PEAK or the measurement network is set to A.

*2 Based on the accuracy of the built-in voltmeter, each value is converted as a current value which is measured by the Network A, B, B1, C and the PCC measurement.

For the other Network's, each value of the current should be read as follow;

·Network D, E ----- \pm (\square % of rdng + \blacksquare A) *the value for " \blacksquare " shall be 1/2 of the specified value.

·Network F ----- \pm (\square % of rdng + \blacksquare A) *the value for " \blacksquare " shall be 1/3 of the specified value.

·Network G ----- \pm (\square % of rdng + \blacksquare A) *the value for " \blacksquare " shall be 1/4 of the specified value.

*3 The accuracy of DC measurement in the RMS mode is the same as the DC mode.

Judgment Function

Pass/fail judgment		Judgment with respect to the upper and lower current reference		
Judgment method		Window comparator		
Judgment action		Judgment starts after the test wait time elapses. The buzzer volume can be set in the range of 0 (off) to 10 separately for PASS and FAIL. The buzzer is valid only for the total judgment result during a program test.		
Selectable range of LOWER/UPPER	UPPER FAIL	Judgment method	Indicates U-FAIL judgment if a current greater than or equal to the upper reference is detected.	
		Indication	Shows U-FAIL on the display.	
		Buzzer	On	
		SIGNAL I/O	Outputs a U-FAIL signal.	
	LOWER FAIL	Judgment method	Indicates L-FAIL judgment after the timer value elapses if a current less than or equal to the lower reference is detected.	
		Indication	Shows L-FAIL on the display.	
		Buzzer	On	
		SIGNAL I/O	Outputs an L-FAIL signal.	
	PASS	Judgment method	Indicates PASS judgment after the timer value elapses if the test is not a failure.	
		Indication	Shows PASS on the display.	
		Buzzer	On	
		SIGNAL I/O	Outputs a PASS signal.	
	PASS HOLD		The time to hold the PASS judgment can be set to a value between 0.2 s and 10.0 s or HOLD (buzzer is fixed to 0.2 s).	
	Selectable range of LOWER/UPPER	RANGE1	PCC	DC, RMS: 30 μ A to 600 μ A, PEAK: 50 μ A to 850 μ A
			Network A, B, B1, and C	
			Network D and E	DC, RMS: 30 μ A to 300 μ A, PEAK: 50 μ A to 424 μ A
Network F			DC, RMS: 30 μ A to 200 μ A, PEAK: 50 μ A to 282 μ A	
Network G			DC, RMS: 30 μ A to 150 μ A, PEAK: 50 μ A to 212 μ A	
RANGE2		PCC	DC, RMS: 601 μ A to 6.00 mA, PEAK: 851 μ A to 8.50 mA	
		Network A, B, B1, and C		
		Network D and E	DC, RMS: 301 μ A to 3.00 mA, PEAK: 425 μ A to 4.24 mA	
		Network F	DC, RMS: 201 μ A to 2.00 mA, PEAK: 283 μ A to 2.82 mA	
		Network G	DC, RMS: 151 μ A to 1.50 mA, PEAK: 213 μ A to 2.12 mA	
RANGE3		PCC	DC, RMS: 6.01 mA to 30.0 mA, PEAK: 8.51 mA to 90.0 mA	
		Network A, B, B1, and C		
		Network D and E	DC, RMS: 3.01 mA to 30.0 mA, PEAK: 4.25 mA to 45.0 mA	
		Network F	DC, RMS: 2.01 mA to 20.0 mA, PEAK: 2.83 mA to 30.0 mA	
		Network G	DC, RMS: 1.51 mA to 15.0 mA, PEAK: 2.13 mA to 22.5 mA	
Judgment accuracy		Conforms to the measurement accuracy. Read rdng as UPPER setting in the measurement accuracy.		

Voltage Measurement Between A and B

Measurement range	DC	10.00 V to 300.0 V
	RMS	10.00 V to 300.0 V
	PEAK	15.00 V to 430.0 V
Input impedance		Approx. 40 M Ω
Accuracy* ¹		$\pm(3\%$ of rdng + 2 V) The measurement range is fixed to AUTO.
SELV detection		The DANGER lamp will illuminate if the specified SELV is exceeded.
	Selectable range	10 V to 99 V. 1 V steps. Off function available

*1. If the voltage is measured with terminals A and B open, the measurement will be prone to the effects of induced voltage.

Timer, Test Function, and Memory

Timer	Test wait time (WAIT)	Selectable range	0 s to 999 s. Set the time until the test actually starts after the test is started.
		Accuracy	$\pm(100\text{ ppm of setting} + 20\text{ ms})$
	Test time (TIMER)	Selectable range	1 s to 999 s. Timer off function available
		Accuracy	$\pm(100\text{ ppm of setting} + 20\text{ ms})$
Test function	AUTO		Automatically executes the test conditions of up to 100 steps.
	MANU		Separately executes the TCC, PCC, and METER measurements.
Memory	Test conditions	AUTO	Up to 100 test sets containing test conditions up to 100 steps (total number of steps: 500). You can set whether or not to supply power to the EUT during the interval time by using LINE BRK (AUTO)* ¹
		MANU	Stores up to 100 sets of test conditions.
	Test results		Select whether to save the test result while delivering the judgment result at the end of the test.
	AUTO		Stores the test results of up to 50 programs.
	MANU		Stores the test results of up to 50 tests.

*1. The TOS3200 may not be able to supply power depending on the settings.

Other Functions

System clock		Records the calibration date and test execution date/time.
	Recordable date/time	Up to year 2099
	Calibration due date setting	Calibration due date can be set. Displays a warning at power-on if the time limit expires.
	CAL. PROTECT ON	Displays a warning and switches to protection status at power-on if the time limit expires.
	CAL. PROTECT OFF	Displays a warning at power-on if the time limit expires.
Measured value conversion (CONV)		Converts the measured current to a value at the preset supply voltage. Invalid for METER measurements.
	Selectable range	80.0 V to 300.0 V. Off function available
MEASURE MODE		The measured value during the measurement period can be selected as follows:
	NORM	Displays the measured value during the measurement period.
	MAX	Displays the maximum value during the measurement period.
Power supply normal/reverse phase selection (POL)		EUT power setting: Normal phase (NORM) or reverse phase (REVS).
Single fault condition selection (COND)		EUT power status setting: Normal (NORM), neutral power line disconnection (FLTLN), or protective earthing conductor disconnection (FLTEA).
Earthing check		Valid only for TC measurement between the enclosure and power line. Measures the current flowing through terminals and performs an earthing check. Generates CONTACT FAIL if the EUT enclosure is grounded.
MEASURE CHECK		Checks the measurement function between measurement terminals A and B of the TOS3200 and switches to protection status if there is a problem. The check is performed by shorting between terminals A and B.
Protection action		Switches to protection status, stops the power supply to the EUT, and opens measurement terminals A and B under the following conditions.
	RELAY SHORT PROTECTION	If an error is detected in the relay operation.
	CALIBRATION DATA PROTECTION	If an error is found in the calibration data.
	OVER LOAD PROTECTION	If the current supplied to the EUT exceeds 15.75 A or if the power exceeds 1500 VA.
	MEASURE PROTECTION	If a failure is detected in the measurement check.
	BACKUP PROTECTION	If an error is found in the backup data.
	OVER RANGE PROTECTION	If the maximum value of the measurement range is exceeded.
	CAL PROTECTION	If the calibration time limit elapses.
	REMOTE PROTECTION	If the REMOTE connector of the front panel is connected or removed or if the ENABLE signal of the SIGNAL I/O connector changes.
Supply voltage measurement AC LINE (EUT)	Measurement range	80.0 V to 250.0 V
	Resolution	0.1 V
	Accuracy	±(3 % of rdng + 1 V)
Supply current measurement AC LINE (EUT)	Measurement range	0.1 A to 15.00 A
	Resolution	0.01 A
	Accuracy	±(5 % of rdng + 30 mA)
Power measurement (Effective power)	Measurement range	10 W to 1500 W
	Accuracy*1	±(5 % of rdng + 8 W)

*1. Supply voltage 80 V or more. Load power factor 1.

Interface

RS232C		D-sub 9-pin connector on the rear panel (conforms to EIA-232-D)			
Data rate		9600 / 19200 / 38400			
GPIB		Complies with IEEE Std.488-1978. SH1, AH1, T6, TE0, L4, LE0, SR1, PP0, DC1, DT0, C0, and E1			
USB		USB Specification 2.0			
REMOTE		6-pin MINIDIN connector on the rear panel Remotely control start/stop by connecting the optional HP21-TOS test probe			
SIGNAL I/O		D-sub 25-pin connector on the rear panel			
1	PM0	I	LSB	LSD MSD	2-digit BCD low-active input Signal input pins for selecting the panel memory or program
2	PM1	I			
3	PM2	I			
4	PM3	I			
5	PM4	I			
6	PM5	I			
7	PM6	I			
8	PM7	I	MSB		
9	STB	I	Panel memory or program signal input terminal		
10	MANU/AUTO	I	Selects single test or program test. (high: single test, low: program test)		
11	STEP_END	O	Output at the end of each step during a program test.		
12	CYCLE_END	O	Output at the end of the last step during a program test.		
13	COM	–	Circuit common		
14	LINE_ON	O	On while power is supplied from AC LINE OUT to the EUT.		
15	TEST	O	On while the test is in progress (excluding the test wait time and interval period).		
16	PASS	O	On for at least 0.2 s (PASS HOLD time) when judgment is PASS. (On continuously if the PASS HOLD time is set to HOLD.)		
17	U-FAIL	O	Continuously on if the judgment is U-FAIL or CONTACT FAIL.		
18	L-FAIL	O	Continuously on if the judgment is L-FAIL or CONTACT FAIL.		
19	READ	O	On during the READY status.		
20	PROTECTION	O	On when a protection is activated.		
21	START	I	Start signal input pin		
22	STOP	I	Stop signal input pin		
23	ENABLE	I	Enable signal input pin of the start signal.		
24	+24V	O	+24-V internal power supply output terminal (maximum output current: 100 mA)		
25	COM	–	Circuit common		
Input specifications	High-level input voltage	11 V to 15 V		Low active control for all input signals. The input pins are pulled up to +12 V by a resistor.	
	Low-level input voltage	0 V to 4 V			
	Low-level input current	-5 mA maximum			
	Input time width	5 ms minimum			
Output specifications	Output type	Open collector output (4.5 Vdc to 30 Vdc).			
	Output withstand voltage	30 Vdc			
	Output saturation voltage	Approx. 1.1 V (25 °C)			
	Maximum output current	400 mA (total)			

General

Display		240 x 64 dot LCD	
Backup battery life		3 years or longer (at 25 °C)	
Measurement terminal	Rated voltage	Between terminals A and B.	250 V
		Between the terminal and chassis	250 V
	Rated current		100 mA
	Measurement category		CAT II
	Active terminal display		Displays the active terminals for the measurement using LED lamps.
Environment	Installation location		Indoors, up to 2000 m
	Spec assured range	Temperature	5 °C to 35 °C (+41 °F to +95 °F)
		Humidity	20 %rh to 80 %rh (no condensation)
	Operating range	Temperature	0 °C to 40 °C (+32°F to +104 °F)
		Humidity	20 %rh to 80 %rh (no condensation)
	Storage range	Temperature	-20 °C to 70 °C (-4 °F to +158 °F)
Humidity		0 to 90 %rh (no condensation)	
Power supply	Nominal input rating		100 Vac to 240 Vac, 50/60 Hz
	Input voltage range (allowable voltage range)		85 Vac to 250 Vac
	Power consumption		70 VA maximum
AC LINE (for the EUT)	Nominal input rating		100 Vac to 240 Vac, 50/60 Hz
	Input voltage range (allowable voltage range)		85 Vac to 250 Vac
	Rated output current		1500 VA (the front panel outlet and the AC LINE OUT terminal block on the rear panel cannot be used simultaneously.)
	Rated operating current		15 A (overcurrent protection: approx. 15.75 A)
	Inrush current		70 Apeak maximum (within 20 ms)
Insulation resistance (between AC LINE and chassis and between measurement terminals and chassis)			30 MΩ or more (500 Vdc)
Withstand voltage (between the AC LINE and chassis)			1390 Vac for 2 seconds, 20 mA or less
Earth continuity			25 Aac/0.1 Ω or less
Safety ^{*1}			Complies with the requirements of the following directives and standards. Low Voltage Directive 2006/95/EC EN 61010-1 Class I Pollution degree 2
Electromagnetic Compatibility (EMC) ^{*1, *2}			Complies with the requirements of the following directives and standards. EMC Directive 2004/108/EC EN 61326-1 EN 61000-3-2 EN 61000-3-3 Applicable condition All of the wires and wires connected to the TOS3200 are less than 3 m in length. Using the accessory test leads.
Outline drawing			See "Outline Drawing".
Weight			Approx. 5 kg (Approx. 11.02 lbs)
Accessories	Test lead (TL21-TOS)		1 set (red and black with alligator clip)
	Flat probe (FP01-TOS)		1 set
	Spare fuse		1 pc.
	Operation manual		1 pc.
	Circuit principle diagram label		1 pc.
	Power cord		2 pcs.

*1. Not applicable to custom order models.

*2. Applies only to models that have CE marking on the panel.

Outline Drawing

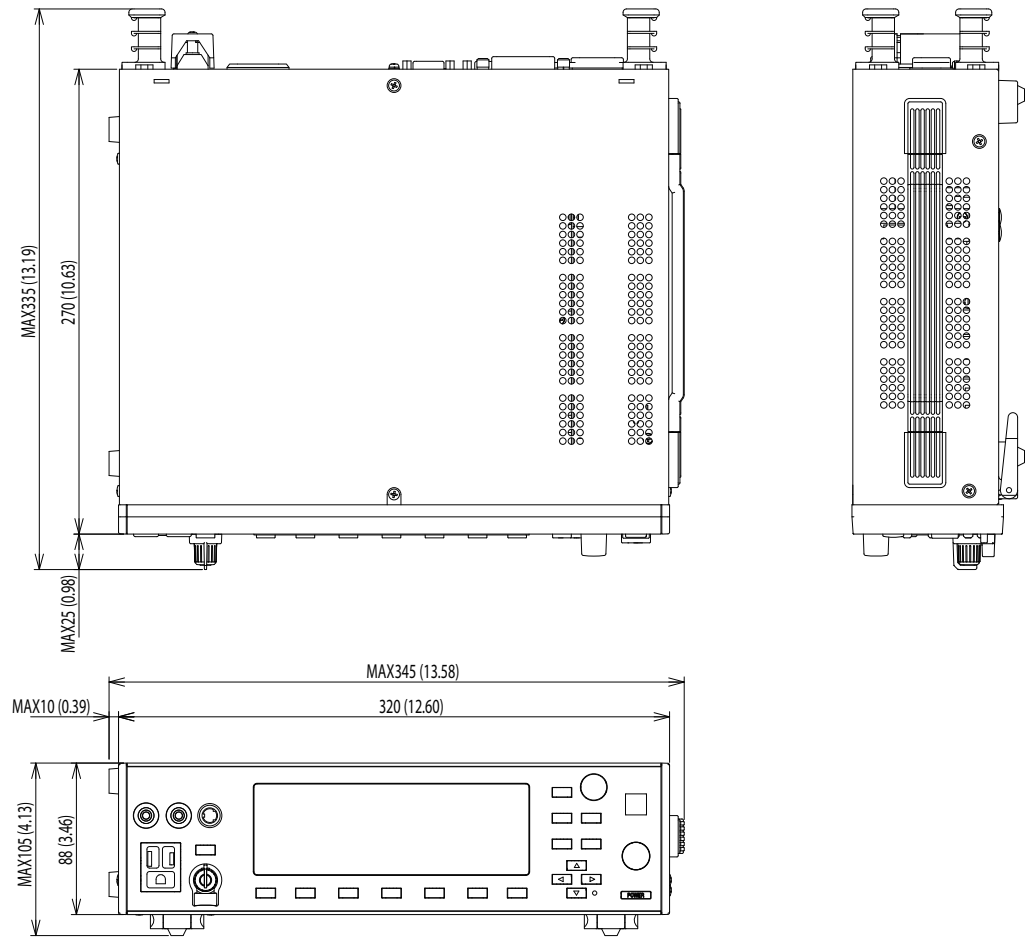

Unit: mm (inch)

Fig. 10-1 TOS3200 outline drawing

Measurement Network (NTWK)

Network A

Comply with IEC60990 fig.3 U1 measurement

Harmonized standard:
IEC61010 etc.

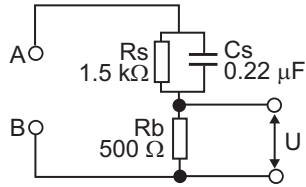

Network D

Applicable standard:

Electrical Appliance and Material Safety Law

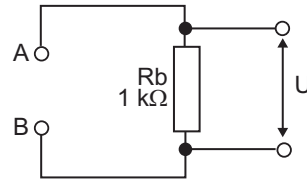

Network B

Comply with IEC60990 fig.4 U2 measurement

Harmonized standard:
IEC60950
IEC60335
IEC60065 U2
IEC50598
IEC61010 etc.

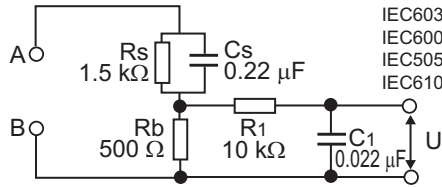

Network E

Applicable standard:

Electrical Appliance and Material Safety Law

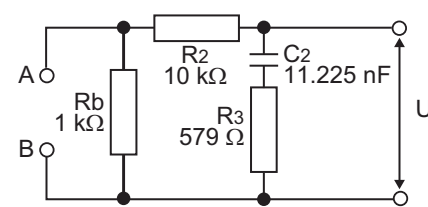

Network B1

Comply with IEC60990 fig.4 U1 measurement

Harmonized standard:
IEC60065 U1 etc.

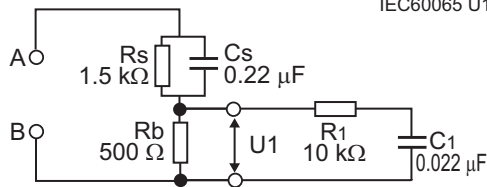

Network F

Applicable standard:

IEC61029 etc.

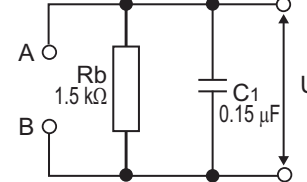

Network C

Comply with IEC60990 fig.5 U3 measurement

Harmonized standard:
IEC60598 etc.

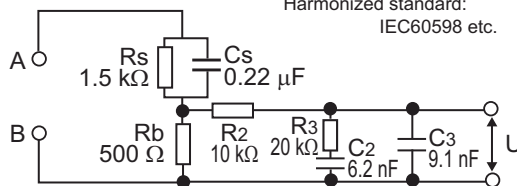

Network G

Applicable standard:

IEC60745 etc.

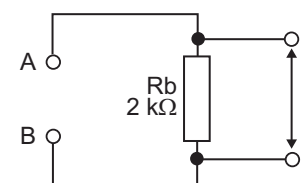

U, U1: Measured voltage between the measurement network reference points

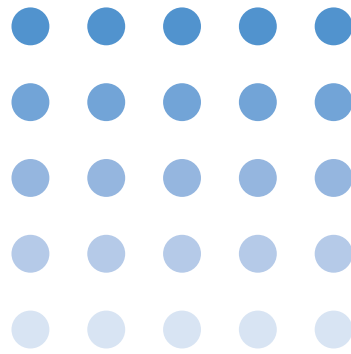

Appendix

- A Glossary
- B Four Principal Tests for Evaluating the Safety of Electrical and Electronic Products
- C A List of Messages
- D A List of Errors
- E Processing Time of Main Commands
- F A List of Default Settings
- G System Settings
- H Protection Function
- I Troubleshooting



Glossary

The terms used in the description of the electrical safety tests is explained below. For a specific definition of each term, refer to the relevant safety standard.

The definitions of the terms indicated here are basically excerpts from the IEC 61010-1 2nd Edition. Excerpts from other standards are indicated in parentheses.

General terms concerning safety

Hazard	Potential source of harm.
Hazardous Live	Capable of rendering an electric shock or electric burn in normal condition or single fault condition.
Accessible (of a part)	Able to be touched with a standard test finger or test pin.
Basic Insulation	Insulation, the failure of which could cause a risk of electric shock.
Supplementary Insulation	Independent insulation applied in addition to basic insulation in order to provide protection against electric shock in the event of a failure of basic insulation.
Double Insulation	Insulation comprising both basic insulation and supplementary insulation.
Reinforced Insulation	Insulation which provides protection against electric shock not less than that provided by double insulation.
Safety extra low voltage (SELV)	Voltage across two locations that are safe to touch under normal or single fault condition.
Clearance	Shortest distance in air between two conductive parts
Creepage Distance	Shortest distance along the surface of the insulating material between two conductive parts.
Enclosure	Part providing protection of equipment against certain external influence and, in any direction, protection against direct contact.
Type Test	Test of one or more samples of equipment (or parts of equipment) made to a particular design, to show that the design and construction meet one or more requirements of the standard.
Routine Test	Test to which each individual device (equipment) is subjected during or after manufacture to ascertain whether it conforms to certain criteria.
Mains	Low-voltage electricity supply system to which the equipment concerned is designed to be connected for the purpose of powering the equipment.
Mains Circuit (Primary Circuit)	Circuit which is intended to be conductively connected to the mains for the purpose of powering the equipment.

Terms concerning the equipment classes and conditions

Class 0 Equipment	Equipment where protection against electric shock is achieved only by basic insulation.
Class 0I Equipment	Equipment in which protection against electric shock is achieved by using basic insulation and a connection to an external protective earthing system. Equipment that cannot be connected to the fixed mains socket with an earthing terminal using a mains power cord that contains a protective earthing conductor. (JIS C 1004-96)
Class I Equipment	Equipment in which protection against electric shock is achieved by using basic insulation and also providing a means of connection to the protective earthing conductor wiring those parts that are otherwise capable of assuming hazardous voltages if the basic insulation fails.
Class II Equipment	Equipment in which protection against electric shock does not rely on basic insulation only, but in which additional safety precautions, such as double insulation or reinforced insulation are provided, there being no reliance on protective earthing.
Class III Equipment	Equipment in which protection against electric shock relies upon supply from SELV circuits and which hazardous voltages are not generated.
Normal Condition	Condition in which all means for protection against hazards are intact.
Single Fault Condition	Condition in which one means for protection against hazard is defective or one fault is present which could cause a hazard.

Terms concerning withstanding voltage and insulation resistance tests

Voltage Test, Dielectric Strength Test, Hipot Test	These terms are all equivalents of the withstanding voltage test. Dielectric strength test is commonly used in the safety standards. Various names are used on the products of equipment manufacturers.
--	---

Terms concerning earth continuity test

Protective Conductor Terminal	Terminal which is bonded to conductive parts of an equipment for safety purposes and is intended to be connected to an external protective earthing system.
Protective Bonding	Electrical connection of accessible conductive parts or protective screening to provide electrical continuity to the means of connection of an external protective conductor.

Terms concerning leakage current test

Limited Current Circuit	A circuit which is so designed and protected that, under both normal operating conditions and single fault conditions, the current which can be drawn is not hazardous. (IEC 60950-1)
Touch Current	Electrical current through a human body when it touches one or more accessible parts. Current that is measured using a body impedance network (body model) that matches the body responses.
Protective Conductor Current	Current flowing through the protective earthing conductor under normal operating conditions.
Body Impedance Network, Measurement Network	Circuit network (body model) representing the human body impedance that is used in the measurement of the TC. There are differences in the body response types and safety standards. However, it is usually defined using resistors and capacitors.
Body Responses	Body responses when a hazardous current flows. There are four types of responses: perception, reaction, let-go, and electric burn. (IEC 60990)

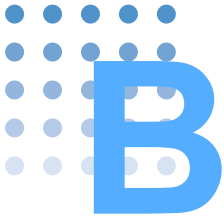

Four Principal Tests for Evaluating the Safety of Electrical and Electronic Products

Electrical products consists of many parts. Mostly, they are composed of electric parts that conduct electricity (conductors) and those that block electricity (insulators). If the insulator between parts that are accessible by humans and parts that are hazardous is defective, electric shock may occur if a human being touches the electric equipment. If the defective insulating part heats up, it may cause a fire. To prevent such accidents, evaluating the safety of electric equipment is extremely important. The typical tests are withstanding voltage test, insulation resistance test, leakage current test, and earth continuity test.

- Withstanding voltage and insulation resistance tests

These tests check whether the insulation performance of insulation section (solid insulation, clearance, etc.) between hazardous section and accessible section are sufficient.

- Leakage current test

This test measures the amount of current that flows assuming the case in which a human actually touches the electric equipment.

- Earth continuity test

This test checks whether the protective bonding is achieved by low resistance for equipment designed to use protective earthing for securing safety.

These four tests are mandatory type tests that must be executed under the safety standards such as IEC and UL as well as the Electrical Appliance and Material Safety Law. The withstanding voltage and earth continuity tests that are performed between the primary circuit (parts connected to the commercial power line that may become an immediate threat) and accessible locations are routine tests that must be performed on all products on a regular basis.

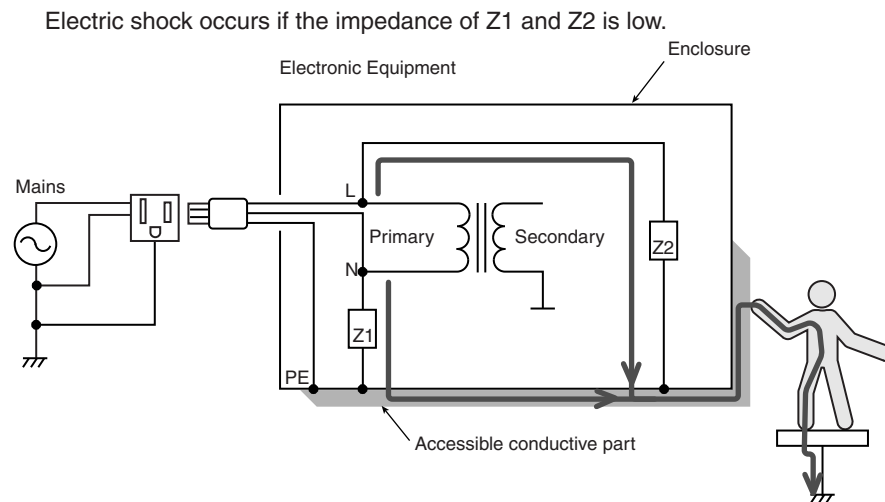

Fig. B-1 Safety evaluation test

Withstanding Voltage Test

The withstanding voltage test evaluates whether the electric insulation section of an electric equipment or parts have sufficient dielectric strength for the working voltage. It is also called dielectric withstand test or hipot test.

In this test, a voltage stress that is much higher than the voltage that is normally applied to the insulation section for a specific time to see whether a dielectric breakdown occurs. If a current flowing through the insulation section exceeds the limit during the test period, it is assumed that a dielectric breakdown occurred. If a dielectric breakdown does not occur, the insulator is assumed to have sufficient dielectric strength.

Measurement principle of the withstanding voltage test

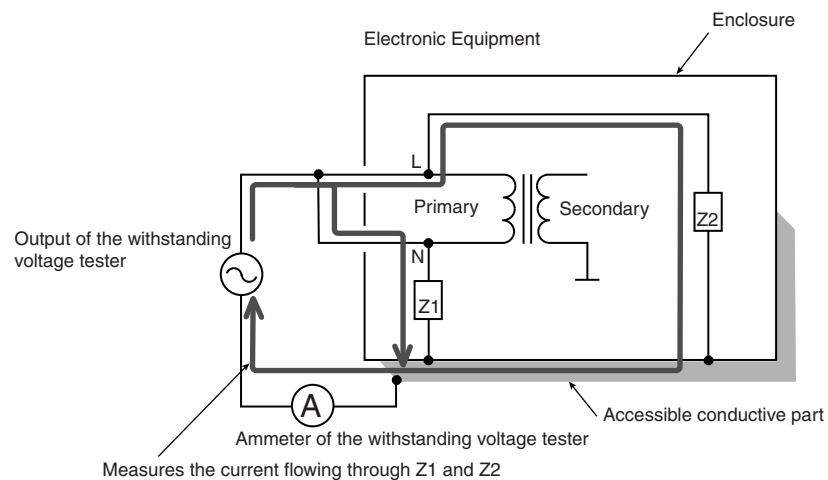

Fig. B-2 Withstanding voltage test

AC test and DC test

For the test between the primary circuit and an accessible section as shown in Fig. B-2, an AC voltage is normally applied. If a filter for eliminating the electromagnetic interference is present in the location corresponding to Z1 or Z2 and its capacitive component is large, the distinction between the current flowing through the filter and the current used to assume a dielectric breakdown will be difficult. In this case, it is recommended that the test be performed using a DC voltage equal to the peak value of the specific AC voltage.

Insulation Resistance Test

This test is the same as the withstanding voltage test in that it is mandatory to prevent electric shock and fire accidents from using the equipment and that it checks the functionality or performance of the insulator. The withstanding voltage test detects insulation defects by checking whether dielectric breakdown occurs. The insulation resistance test detects insulation defects by measuring the resistance.

After absorbing the moisture of the equipment (sometimes this is not done), a specific DC voltage that is 5 to 10 times higher than the normal voltage is applied, and the resistance is measured from the amount of current that flows. If the insulation resistance is sufficient, the equipment meets the requirements for preventing electric shock and fire accidents.

Measurement principle of the insulation resistance test

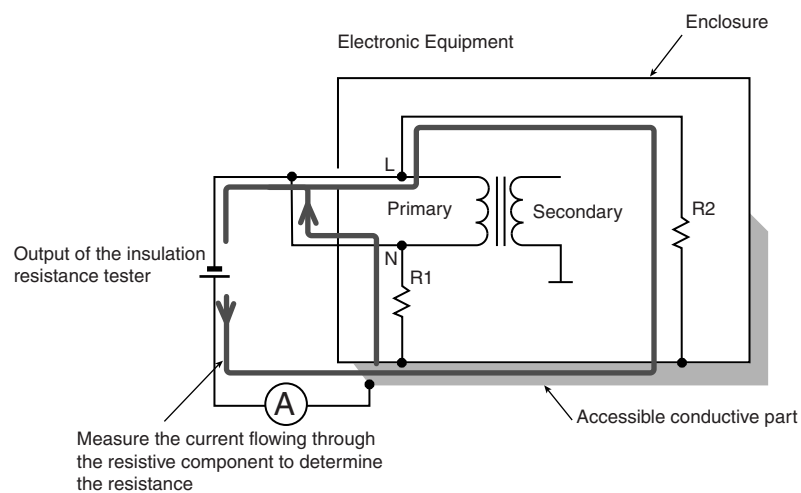

Fig. B-3 Insulation resistance test

Why DC voltage is used to perform the insulation resistance test

The insulation resistance test measures the resistive component of the insulator. The capacitive component is ignored. The equipment is only safe if at least a given insulation resistance (a value specified by a standard) is maintained. The insulation resistance test is performed to check this resistance. If the insulation resistance test is performed using an AC voltage, we end up measuring the impedance of the capacitive component and prevents us from obtaining the required insulation resistance. This is the reason why the insulation resistance test is performed using a DC voltage.

Earth Continuity Test

This test verifies the integrity (continuity) of the protective bonding of the equipment (Class I equipment) designed to secure safety through the basic insulation and protective earthing. It is also called earth (ground) bonding test.

In this test, a current in the range of 10 A to 60 A is applied for 60 seconds to few minutes. The resistance is measured by measuring the voltage. The test current is determined by the rating of the distribution system (such as 1.5 or 2 times the distribution system). Many standards define the resistance limit to less than or equal to 0.1Ω (some standards define the limit by the voltage drop) and the open-circuit voltage (no-load voltage) to less than or equal to 6 V or 12 V.

If the continuity of the protective bonding is confirmed, we can conclude that the equipment has the requirements for preventing electric shock even if the insulation between the primary circuit and the accessible conductive section fails and a fault current flows through the distribution system.

Measurement principle of the earth continuity test

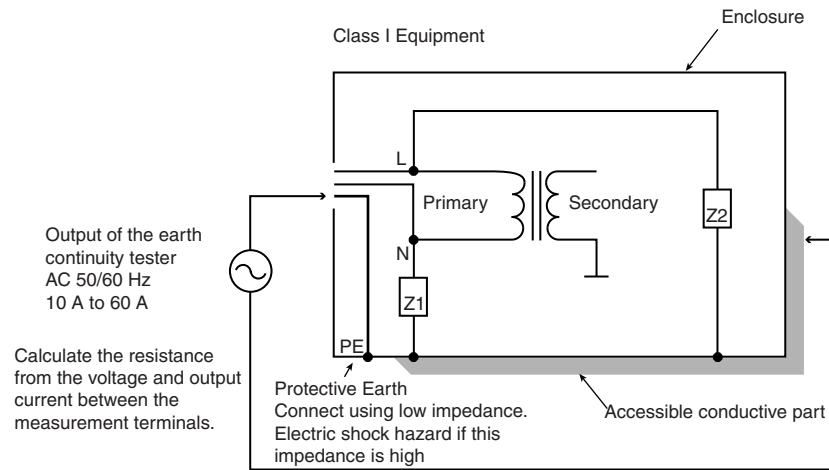

Fig. B-4 Earth continuity test

Leakage Current Test

The term *Touch Current* and *Protective Conductor Current* are defined in the latest international standard, IEC 60990. These terms were previously referred to as *Leakage Current*.

- Touch Current (TC)
Current that flows when a human body touches the equipment. If the measured TC does not exceed the value hazardous to a human body as defined by a safety standard or the like, the equipment meets the requirements for preventing electric shock.
- Protective Conductor Current (PCC)
Current that flows through the protective conductor of equipment that is furnished with normal protective bonding. The measurement of the PCC also serves the purpose of checking the compatibility with the distribution system of the equipment.

Differences from the withstanding voltage and insulation resistance tests

The withstanding voltage and insulation resistance tests measure the current flowing through the insulator of the EUT. The TC test measures the current flowing through a body impedance network, and the PCC test measures the current flowing through the protective conductor. The term *leakage current* applies to all these cases. However, the term *leakage current test* generally refers to tests that measure the TC or PCC.

Measurement principle of the leakage current test

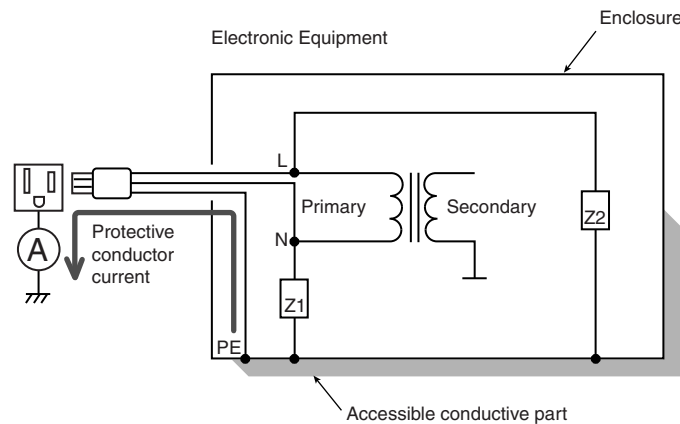

Fig. B-5 Leakage current test 1
Typical example of PCC measurement

In this test, power is fed to the EUT, and the current flowing through the protective conductor is measured under normal operation.

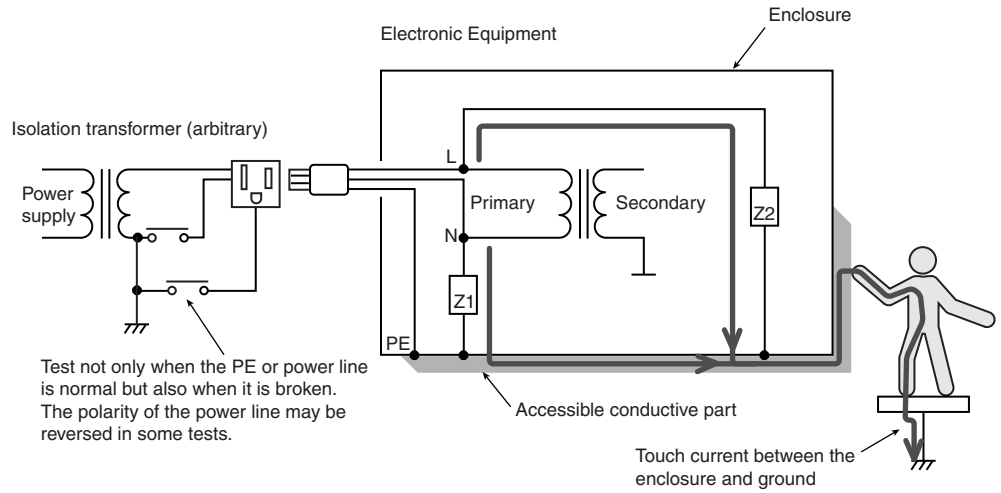

Fig. A-1 Leakage current test 2
Typical example of TC measurement

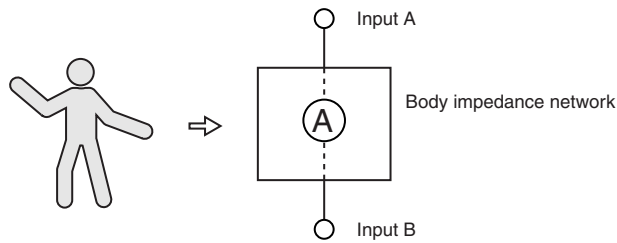

Fig. B-6 Body impedance network

A body impedance network is connected in place of an actual human body, and the current flowing through the network is measured. In some cases, the TC between the enclosure and the power line or that between the enclosure and another enclosure is also measured in addition to the TC between the enclosure and ground.

Reference

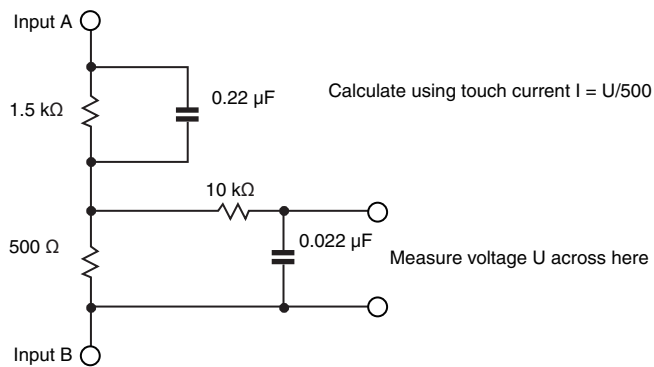
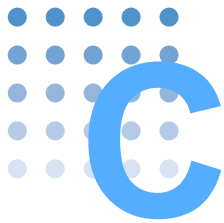

Fig. B-7 Example of a body impedance network



A List of Messages

SCPI command: Command name in the short form.

Affected: Yes for commands that are affected by *RST and *RCL.

R/W: Query command (R)/set command (W).

*: 1, 2, and 3 indicate SCPI standard command, command in review, and KIKUSUI original command, respectively.

PROGRAM subsystem

SCPI Command		Setting		Default	Response	Affected	Description	R/W	*
Program header	Parameter		Unit						
PROGRAM									3
:ADD	NR1	1 to 100 ^{*1}					Sets the step count.	W	3
:COUN					NR1		Queries the number of steps that has been secured.	R	3
:FREE					NR1		Queries the number of steps that can be set.	R	3
:MODE	char	RMS DC PEAK		RMS	char		Sets the current measurement mode of the selected program.	R/W	3
:RANG:SEL	char	AUTO FIX		AUTO	char		Sets the measurement range of the selected program.	R/W	3
:DEL							Deletes all the secured steps.	W	3
:EXEC					char		Queries the execution status of the test.	R	3
					NR3		Queries the elapsed time.		
					NR3		Queries the remaining time.		
					NR1		Queries the program number.		
					NR1		Queries the step number.		
:FAB	bool			OFF	NR1		Whether to continue the test after a failure judgment.	R/W	3
:NAME	NR1	-1 to 99		-1	NR1		Selects the program number.	R/W	3
:NETW	string	A B B 1 C D E F G		A	string		Sets the measurement circuit of the selected program.	R/W	3
STEP:EDIT									
:LINE	NR1	0 to 99					Specifies the step number to be set.	W	3
	char	TC PCC		TC	char		Sets the operation mode. ^{*2}		
	char	ENCPE ENCENC ENCLIV ENCNEU NA		ENCPE	char		Sets the measurement terminal destination. ^{*2}		
	char	NORM REV NA		NORM	char		Sets the power line polarity. ^{*2}		
	char	NORM FLTNEU FLTPE NA		NORM	char		Sets the single fault mode. ^{*2}		
	numeric	1 to 99, 9.9E37	S	1	NR1		Sets the interval. ^{*2} 9.9E37 is hold.		
:PAR	NR1	0 to 99					Specifies the step number to be set.	W	3
	numeric	^{*3}	A	30 μ	NR3		Sets the lower reference. ^{*4}		
	bool			OFF	NR1		Turns on/off the lower reference judgment. ^{*4}		
	numeric	^{*3}	A	15 m	NR3		Sets the upper reference. ^{*4}		
	bool			ON	NR1		Turns on/off the upper reference judgment. ^{*4}		
	numeric	1 to 999	S	1	NR1		Sets the test time. ^{*4}		
	bool			ON	NR1		Turns on/off the test time. ^{*4}		
	numeric	1 to 999	S	1	NR1		Sets the test wait time. ^{*4}		
bool			OFF	NR1		Turns on/off the test wait time. ^{*4}			
:TITL	string	12 characters		--UNTITLED--	string		Sets the program name.	R/W	3

*1. The total number of steps of all programs is 500.

*2. Sets the step details of the selected program.

*3. Varies depending on the current measurement mode and the measurement network settings.

*4. Sets the step parameters of the selected program.

READ / MEASure subsystem

SCPI Command		Setting		Default	Response	Affected	Description	R/W	*
Program header	Parameter		Unit						
READ[:SCAL] MEAS[:SCAL]									
:CURR									
	:LEAK				NR3		Queries the measured current.	R	3
	:MAX				NR3		Queries the maximum measured current.	R	3
	:LINE				NR3		Query the EUT current.	R	3
:VOLT									
	:AB				NR3		Queries the measured voltage.	R	3
	:MAX				NR3		Queries the maximum measured voltage.	R	3
	:LINE				NR3		Query the EUT voltage.	R	3
	:UX				NR3		Query the measured voltage between the measurement network reference points.	R	3
	:MAX				NR3		Queries the maximum measured voltage between the reference points.	R	3
	:POW:LINE				NR3		Query the EUT power.	R	3

RESult subsystem

SCPI Command		Setting		Default	Response	Affected	Description	R/W	*
Program header	Parameter		Unit						
RES									
	[:IMM]				char		Queries the judgment result of the test.	R	3
					NR3		Queries the measured current.	R	3
:MAN :AUTO *1									
:HEAD		NR1	1 to 50				Specifies the memory number.	R	3
					string		Memory name or program name*2		
					NR1		Program number.*2		
					NR1		Total number of steps.*2		
					char		Measurement network.*2		
					char		Measurement mode.*2		
					char		Measurement range.*2		
					char		Normal current measurement or maximum current hold.*2		
					char		Program judgment.*2		
					*3		Test start date/time.*2		
				*3		Test end date/time.*2			
:DATA		NR1	1 to 50				Specifies the memory number.	R	3
		NR1*4	0 to 99				Specifies the step number.		
					NR1		Step number.*5		
					char		Measurement mode.*5		
					char		Connection destination of the measurement terminal.*5		
					char		Polarity.*5		
					char		Single fault mode.*5		
					NR3		Test time.*5		
					NR3		Measured current.*5		
					char		Judgment (step).*5		
				*3		Test start date/time.*5			
				*3		Test end date/time.*5			
:DEL	NR1	1 to 50					Deletes the contents of the specified memory number.	W	3
:ALL							Deletes all memory contents.	W	3
:SAVE	NR1	1 to 50					Saves the test result to the specified memory number.	W	3

- *1. Specify MAN to save and query the manual test. Specify AUTO to save and query that auto test.
 *2. Queries the header information of the specified memory number.
 *3. Response format: YYYY/MM/DD hh:mm:ss
 *4. AUTO only.
 *5. Queries the test data information of the specified memory number and step (auto test only).

[SENSe] subsystem

SCPI Command		Setting		Default	Response	Affected	Description	R/W	*
Program header	Parameter		Unit						
[SENS:]									
CURR					string		Queries the current setting.	R	1
:MAX:CLE							Clears the maximum measured current.	W	3
:MODE	char	RMS DC PEAK		RMS	char	Yes	Set the current measurement mode.	R/W	3
:NETW	string	A B B1 C D E F G			string	Yes	Sets the measurement network.	R/W	3
:RANG:SEL	char	AUTO LOW MED HIGH		AUTO	char		Sets the measurement range.	R/W	3
VOLT					string		Queries the voltage setting.	R	1
:MAX:CLE							Clears the maximum measured voltage.	W	3
:MODE	char	RMS DC PEAK		RMS	char	Yes	Set the voltage measurement mode.	R/W	3
FUNC[:ON]	string	CURR PCC TC VOLT AUTO		TC	string	Yes	Sets the operation mode.	R/W	1
TC PCC*1					string		Queries the setting.	R	3
:COND	char	NORM FLTNEU FLTPE*2		NORM	char	Yes	Sets the single fault mode.	R/W	3
:EXEC					char		Queries the execution status of the test.	R	3
					NR3		Queries the elapsed time.		
					NR3		Queries the remaining time.		
					NR1		Queries the program number.		
					NR1		Queries the step number.		
:LIM									
:LOW									
[:LEV]	numeric	*3	A	30 μ	NR3	Yes	Sets the lower reference.	R/W	3
:STATE	bool			OFF	NR1	Yes	Turns on/off the lower reference judgment.	R/W	3
:UPP									
[:LEV]	numeric	*3	A	30 m	NR3	Yes	Sets the upper reference.	R/W	3
:STATE	bool			ON	NR1	Yes	Turns on/off the upper reference judgment.	R/W	3
:MODE	char	RMS DC PEAK		RMS	char	Yes	Set the current measurement mode.	R/W	3
:NETW (TC only)	string	A B B1 C D E F G		A	string	Yes	Sets the measurement network.	R/W	3
:POL	char	NORM REV		NORM	char	Yes	Sets the power line polarity.	R/W	3
:PROB (TC only)	char	ENCPE ENCENC ENCLIV ENCNEU		ENCPE	char	Yes	Sets the connection destination of measurement terminals A and B.	R/W	3
:RANG:SEL	char	AUTO FIX		AUTO	char		Sets the measurement range.	R/W	3
:TIM									
[:TIME]	numeric	1 to 999	S	10	NR3	Yes	Sets the test time.	R/W	3
:STAT	bool			OFF	NR1	Yes	Turns on/off the test time.	R/W	3
:WAIT									
[:TIME]	numeric	1 to 999	S	1	NR3	Yes	Sets the test wait time.	R/W	3
:STAT	bool			OFF	NR1	Yes	Turns on/off the test wait time.	R/W	3

- *1. Specify TC for touch current measurement and PCC for PCC measurement.
- *2. FLTPE available only for TC.
- *3. Varies depending on the current measurement mode and the measurement network settings.

STATUS subsystem

SCPI Command		Setting		Default	Response	Affected	Description	R/W	*
Program header	Parameter		Unit						
STAT									
:OPER									
	[:EVEN]				NR1		Queries the event register. ^{*1}	R	1
	:COND				NR1		Queries the register status. ^{*1}	R	1
	:ENAB	NRf	0 to 32767		NR1		Enable. ^{*1}	R/W	1
	:NTR	NRf	0 to 32767		NR1		Negative transition. ^{*1}	R/W	1
	:PTR	NRf	0 to 32767		NR1		Positive transition. ^{*1}	R/W	1
	:PRES						Initializes the filter register.	W	1
:QUES									
	[:EVEN]				NR1		Queries the event register. ^{*2}	R	1
	:COND				NR1		Queries the register status. ^{*2}	R	1
	:ENAB	NRf	0 to 32767		NR1		Enable. ^{*2}	R/W	1
	:NTR	NRf	0 to 32767		NR1		Positive transition. ^{*2}	R/W	1
	:PTR	NRf	0 to 32767		NR1		Negative transition. ^{*2}	R/W	1

*1. OPERation status register.

*2. QUESTionable status register.

SYSTEM subsystem

SCPI Command		Setting		Default	Response	Affected	Description	R/W	*	
Program header	Parameter		Unit							
SYST										
:BEEP:VOL										
	:FAIL	numeric	0 to 10		3	NR3	Sets the volume of the buzzer that sounds when the judgment is FAIL.	R/W	3	
	:PASS	numeric	0 to 10		3	NR3	Sets the volume of the buzzer that sounds when the judgment is PASS.	R/W	3	
:CONF										
	:CONV	numeric	0, 80.0 to 300.0	V	0	NR3	Sets the supply voltage used to convert to current. Specify zero when not converting to current.	R/W	3	
	:LBR	bool			ON	NR1	Sets whether or not to shut off the power supply to the EUT during the interval time.	R/W	3	
	:MMOD	char	NORM MAX		NORM	char	Yes	Sets whether to hold the maximum measured current.	R/W	3
	:PHOL	numeric	0.2 to 10.0, 9.9E37	S	2	NR3	Sets the time to hold the PASS setting. 9.9E37 is hold.	R/W	3	
	:SELV	numeric	0, 10 to 99	V	0	NR3	Sets the safety extra low voltage (SELV). Specify zero to turn the SELV function off.	R/W	3	
	:TRAC	bool			OFF	NR1	Turns on/off the communication error trace function.	R/W	3	
	:DATE	NR1	2002 to 2099			NR1	Sets the year.	R/W	1	
		NR1	1 to 12			NR1	Sets the month.			
		NR1	1 to 31			NR1	Sets the day.			
	:ERR[:NEXT]						Queries the error and event information.	R	1	
	:KLOCK	bool			OFF	NR1	Turns on/off the panel operation lock.	R/W	1	
	:LOC						Sets to local mode (RS232C and USB only).	W	2	
	:OPT					char	Queries the options.	R	3	
	:PROT:CLE						Releases the protection status.	W		
	:REM						Enables remote mode and locks all key and switches besides the LOCAL key and STOP switch (RS232C and USB only).	W	2	
	:RWL						Enables remote mode and locks all key and switches besides STOP switch (RS232C and USB only).	W	2	
	:TIME	NR1	0 to 23			NR1	Sets the hour.	R/W	1	
		NR1	0 to 59			NR1	Sets the minute.			
		NR1	0 to 59			NR1	Sets the second.			
	:VERS					1999.0	Queries the SCPI specification version with which the TOS3200 complies.	R	1	

TRIGGER subsystem

SCPI Command		Setting		Default	Response	Affected	Description	R/W	*
Program header	Parameter		Unit						
ABOR							Aborts the test.	W	1
INIT[:IMM]									
	[:SEQ[1]]						Starts the test (trigger function).	W	1
	:NAME	char	TEST					W	1

SCPI Command		Setting		Default	Response	Affected	Description	R/W	*
Program header	Parameter		Unit						
TRIG									
[:SEQ[1]] [:TEST]1									
:SOUR	char	IMM BUS		IMM	char	Yes	Sets the trigger source.	R/W	1
:HREL							Releases the in-progress status of the interval time.	W	3

Other subsystem

SCPI Command		Setting		Default	Response	Affected	Description	R/W	*
Program header	Parameter		Unit						
DISP									
:CONT	numeric	0 to 10		5	NR3		Sets the screen brightness.	R/W	1
:SIZE	char	NORM ENL		NORM	char		Switches the test-in-progress display.	R/W	3
:UXV	bool			OFF	NR1		Sets whether or not to display the voltage in expanded numeric display mode.	R/W	3
MEM									
:RCL	NR1	0 to 99					Recalls the panel memory.	W	3
:SAV	NR1	0 to 99					Saves to the panel memory.	W	3
:TITLE	NR1	0 to 99					Sets the panel memory number.	R/W	3
	string	12 characters					Sets the memory name.		
OUTP									
:LINE[:STATE]	bool			OFF	NR1	Yes	Turns on/off the EUT power line.	R/W	3

IEEE488.2 common commands

IEEE488.2 common command	Parameter	Description	R/W
*CLS		Clears all the event registers.	W
*ESE	NR1	Sets the event status enable register bits.	R/W
*ESR		Queries the event status register.	R
*IDN		Queries the identification string (manufacturer information).	R
*OPC		Causes the device to generate the operation complete message in the event status register when all pending selected device operations have been finished.	R/W
*OPT		Queries the installed options.	R
*RCL	NR1	Recalls the contents saved to the memory.	W
*RST		Performs a device reset. Configures the device to a known condition independent from the usage history of the device.	W
*SAV	NR1	Saves the present settings to the memory.	W
*SRE	NR1	Sets the service request enable register.	R/W
*STB		Queries the contents of the status byte register and the master summary status message.	R
*TRG		Trigger command.	W
*TST		Executes a self-test.	R
*WAI		Prevents the device from executing subsequent commands or queries until all operations in standby are complete.	W

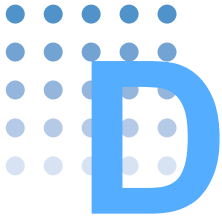

A List of Errors

Command errors

An error in the range [-199, -100] indicates that an IEEE 488.2 syntax error has been detected by the instrument's parser. The occurrence of any error in this class shall cause the command error bit (bit 5) in the event status register to be set.

Error code	Error message description	
-100	Command error	Command error. A generic syntax error.
-101	Invalid character	Invalid character is present. A data element different from those that are allowed was encountered.
-102	Syntax error	Syntax error. An unrecognized syntax was encountered in the command string.
-103	Invalid separator	An invalid separator exists in the command string.
-104	Data type error	The parser recognized a data element different than one allowed.
-105	GET not allowed	A Group Execute Trigger was received within a program message.
-108	Parameter not allowed	More parameters were received than expected for the header.
-109	Missing parameter	Fewer parameters were received than required for the header.
-110	Command header error	An error was detected in the header.
-120	Numeric data error	Generated when parsing a data element which appears to be numeric, including the nondecimal numeric types.
-130	Suffix error	Generated when parsing a suffix.
-131	Invalid suffix	The suffix does not follow the syntax, or the suffix is inappropriate for the TOS3200.
-134	Suffix too long	The suffix of the numeric element is too long.
-138	Suffix not allowed	A suffix was encountered after a numeric element which does not allow suffixes.
-140	Character data error	Generated when parsing a character data element.
-141	Invalid character data	–
-144	Character data too Long	Characters in the character data element are too long.
-148	Character data not allowed	–
-150	String data error	Generated when parsing a string data element.
-160	Block data error	Generated when parsing a block data element.
-170	Expression error	Generated when parsing an expression data element.
-180	Macro error	–

Execution errors

An error in the range [-299, -200] indicates that an error has been detected by the instrument's execution control block. The occurrence of any error in this class shall cause the execution error bit (bit 4) in the event status register to be set.

Error code		Error message description
-200	Execution error (generic)	A generic error for the TOS3200.
-203	Command protected	Password protected program or query command cannot be executed.
-210	Trigger error	–
-211	Trigger ignored	A trigger was received but discarded.
-213	Init ignored	Measurement initiate operation was ignored because measurement is in progress.
-214	Trigger deadlock	Dead lock occurred because a query was received before the software trigger.
-220	Parameter error	Invalid parameter.
-221	Settings conflict	Received a command that cannot be executed in the present condition of the TOS3200.
-222	Data out of range	Parameter out of range.
-223	Too much data	Too many parameters.
-224	Illegal parameter value	Received an invalid parameter data.
-230	Data corrupt or stale	Received a data query before the measurement was completed.
-241	Hardware missing	Cannot be executed because the optional hardware is not installed.

Device-specific errors

Error code		Error message description
-330	Self-test failed	–
-360	Communication error	–
-361	Parity error in program message	The parity bit is not correct.
-362	Framing error in program message	The stop bit cannot be detected.
-363	Input buffer overrun	–
-365	Time out error	–

Query errors

An error in the range [-499, -400] indicates that the output queue control of the instrument has detected a problem with the message exchange protocol described in IEEE 488.2, chapter 6. The occurrence of any error in this class shall cause the query error bit (bit 2) in the event status register to be set.

Error code		Error message description
-400	Query error (generic)	A generic error for the TOS3200.
-410	Query INTERRUPTED	Received a new command before the response to the previous query was read.
-420	Query UNTERMINATED	The controller attempted to read the response after the TOS3200 received an unsupported query or has not received a query. The -100 "Command error" and this error is stored in the error queue. The controller will time out.
-430	Query DEADLOCKED	The error queue, input buffer, and output buffer are full when sending large binary data as a response, and the transmission timing is off.
-440	Query UNTERMINATED after indefinite response	Received a separate query in semicolon-delimited format after a query that returns a response in an indefinite form. (Example) *IDN? ; SYST : ERR?

Operation complete event errors

An error in the range [-899, -800] is used when the TOS wants to report an IEEE488.2 operation complete event. This event occurs when the instrument's synchronization protocol, having been enabled by an *OPC command, completes all selected pending operations. This event also sets the operation complete bit (bit 0) of the standard event status register.

Error code		Error message description
-800	Operation complete	–

Errors specific to the TOS3200

Error code		Error message description
201	Operation denied while TEST is running	Operation denied because the test is in progress.
202	Operation denied due to Empty PROGRAM	Operation denied because the program is not set.
203	Operation denied due to PROTECTED state	Operation is denied because the protection status is activated.
901	Relay malfunctioning	Relay operation error.
902	Calibration data broken	Calibration data error.



Processing Time of Main Commands

The time until the next command is accepted.

The processing times indicated here are typical values. They are not warranted. The processing time varies depending on the setup and measurement conditions. It does not include the response time of the hardware.

Command	GPIB*1 processing time (ms)	USB processing time (ms)	RS232C processing time (ms)		Description
			19200	38400	
*CLS	12	11	14	13	Clears the register.
TC:NETW "B"	17	15	81	69	Sets the measurement network.
MEAS:CURRE:LEAK?	17	41	33	32	Queries the measured current.
STAT:OPER:COND?	36	37	69	57	Queries the register status.
RES?	17	14	33	32	Queries the test judgment result.

*1. Using USB-GPIB by National Instruments.

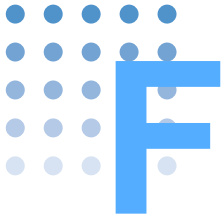

A List of Default Settings

Initializing the TOS3200

While holding down the SHIFT key, turn on the POWER switch. The TOS3200 displays the firmware version followed by "INITIALIZING!" and starts to initialize.

If you initialize the TOS3200, various settings such as the test conditions and the saved data will be set to the default values indicated below.

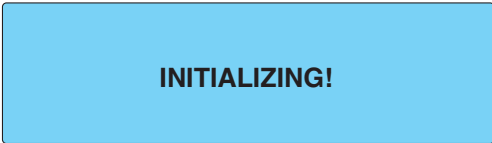

Default values

Item		Command	Setting after initialization	Setting after sending the command	
				*RST	*RCL
Operation mode		FUNC	TC	←	Depends on the memory contents.
TC measurement conditions (TC)	PROBE	TC:PROB	ENCPE	←	Depends on the memory contents.
	POL	TC:POL	NORM		
	COND	TC:COND	NORM		
	LOWER	TC:LIM:LOW	30 μ A		
	LOWER ON/OFF	TC:LIM:LOW:STAT	OFF		
	UPPER	TC:LIM:UPP	30 mA		
	UPPER ON/OFF	TC:LIM:UPP:STAT	ON		
	TIMER	TC:TIM	10 s		
	TIMER ON/OFF	TC:TIM:STAT	OFF		
	WAIT	TC:WAIT	1 s		
	WAIT ON/OFF	TC:WAIT:STAT	OFF		
	NTWK	TC:NETW	A		
	MODE	TC:MODE	RMS		
	RANGE	TC:RANG:SEL	AUTO		
PCC measurement conditions (PCC)	POL	PCC:POL	NORM	←	Depends on the memory contents.
	COND	PCC:COND	NORM		
	LOWER	PCC:LIM:LOW	30 μ A		
	LOWER ON/OFF	PCC:LIM:LOW:STAT	OFF		
	UPPER	PCC:LIM:UPP	30 mA		
	UPPER ON/OFF	PCC:LIM:UPP:STAT	ON		
	TIMER	PCC:TIM	10 s		
	TIMER ON/OFF	PCC:TIM:STAT	OFF		
	WAIT	PCC:WAIT	1 s		
	WAIT ON/OFF	PCC:WAIT:STAT	OFF		
	MODE	PCC:MODE	RMS		
	RANGE	PCC:RANGE:SEL	AUTO		

Item		Command	Setting after initialization	Setting after sending the command	
				*RST	*RCL
Meter mode measurement conditions (METER)	NTWK	CURR:NETW	A	←	Depends on the memory contents.
	MODE	CURR:MODE	RMS		
		VOLT:MODE	RMS		
RANGE	CURR:RANG:SEL	AUTO			
System settings (SYSTEM)	MEAS MODE	SYST:CONF:MMOD	NORM	No change	←
	PASS HOLD	SYST:CONF:PHOL	2.0 s		
	CONV	SYST:CONF:CONV	OFF		
	SELV	SYST:CONF:SELV	OFF		
	BUS VOL (PASS)	SYST:BEEP:VOL:PASS	3		
	BUS VOL(FAIL)	SYST:BEEP:VOL:FAIL	3		
	CONTRAST	DISP:CONT	5		
	LINE BRK (AUTO)	SYST:CONF:LBR	ON		
	TIME ADJUST	SYST:DATE / SYST:TIME	No change ^{*1}		
	CAL. DATE	–			
	ALARM	–			
	CAL. PROTECT	–	ON		
Interface settings (INTERFACE)	I/F SELECT	–	GPIB	No change	←
	GPIB ADDRESS	–	3		
	BAUDRATE	–	19200		
	DATA BITS	–	8		
	X-FLOW	–	ON		
	STOP BITS	–	1		
	TALK MODE	–	OFF		
	ERR TRACE	SYST:ERR:TRAC	OFF		
Individual test data	–	No saved data	No change	←	
Program test data	–	No saved data			
Panel memory	–	See .			
Sequence program	–	No registered steps			
Trigger source (during remote control)	TRIG:SOUR	IMM	←	←	
Sets the program number (during remote control)	PROG:NAME	-1 ^{*2}	←	←	
Power supply line	OUTP:LINE	OFF	←	←	
Display during testing	DISP:SIZE	NORM	No change	←	
Voltage display in expanded display mode	DISP:UXV	OFF	No change	←	

*1. The factory default settings are shown below.

TIME ADJUST: Standard Japanese time at factory shipment.

CAL. DATE: Calibration date at factory shipment.

ALARM: One year after CAL. DATE.

*2. Aborts the program operation.

Default Values of the Panel Memory

There are a total of 100 panel memories. By factory default, memory numbers 00 to 50 contain preset test conditions of TC measurement conforming to various safety standards. These memory numbers can be overwritten as with 51 to 99.

The contents of the panel memory will be reset to default values if the TOS3200 is initialized.

Default values of memory numbers 00 to 50

The default values for items other than those indicated in this table are set to the value of item B in below table.

No.	Memory name	NTWK	PROBE	POL	COND	MODE	UPPER	Notes
-----	-------------	------	-------	-----	------	------	-------	-------

IEC 60990 Methods of measurement of TC and PCC

00	IEC60990(1)	B	ENCPE	NORM	NORM	RMS	0.5 mA	Response limit
01	IEC60990(2)	C					10 mA	Let-go limit
02	IEC60990(3)	A					30.0 mA	Electric burn limit

IEC 60950-1 Information technology equipment - Safety - Part 1: General requirements

03	IEC60950(1)	B	ENCPE	NORM	NORM	RMS	0.25 mA	All equipment
04	IEC60950(2)		REVS					
05	IEC60950(3)		ENCNEU	-	-		0.5 mA	Class 0I equipment, hand-held equipment
06	IEC60950(4)		ENCLIV					
07	IEC60950(5)		ENCNEU				0.75 mA	Class I equipment, hand-held equipment
08	IEC60950(6)		ENCLIV					
09	IEC60950(7)		ENCNEU				1 mA	Class 0I equipment, other equipment
10	IEC60950(8)		ENCLIV					
11	IEC60950(9)		ENCNEU				3.5 mA	Class I equipment, other equipment
12	IEC60950(10)		ENCLIV					

IEC 60335-1 Household and similar electrical appliances - Safety - Part 1: General requirements

13	IEC60335(1)	B	ENCLIV	-	-	RMS	0.5 mA	Class 0 and 0I equipment
14	IEC60335(2)		ENCNEU					
15	IEC60335(3)		ENCLIV				0.75 mA	Class I equipment, hand-held equipment
16	IEC60335(4)		ENCNEU					
17	IEC60335(5)		ENCLIV				3.5 mA	Class I equipment, motor equipment
18	IEC60335(6)		ENCNEU					
19	IEC60335(7)		ENCLIV				0.25 mA	Class II equipment
20	IEC60335(8)		ENCNEU					

IEC 60065 Audio, video and similar electronic apparatus - Safety requirements

21	IEC60065(1)	B	EncEnc	NORM	NORM	PEAK	0.7 mA	
22	IEC60065(2)		ENCLIV	-	-			
23	IEC60065(3)		ENCNEU					
24	IEC60065(4)	B1*1	EncEnc	NORM	NORM	70 mA	100 kHz or higher in frequency (electrical burn)	
25	IEC60065(5)		ENCLIV	-	-			
26	IEC60065(6)		ENCNEU					
27	IEC60065(7)		EncEnc	NORM	NORM	DC	2 mA	
28	IEC60065(8)		ENCLIV	-	-			
29	IEC60065(9)		ENCNEU					

No.	Memory name	NTWK	PROBE	POL	COND	MODE	UPPER	Notes
-----	-------------	------	-------	-----	------	------	-------	-------

IEC 60745-1 Hand-held motor-operated electric tools - Safety - Part 1: General requirements

30	IEC60745(1)	G	ENCLIV	-	-	RMS	0.5 mA	Class 0I equipment
31	IEC60745(2)		ENCNEU					
32	IEC60745(3)		ENCLIV				0.75 mA	Class I instrument
33	IEC60745(4)		ENCNEU					
34	IEC60745(5)		ENCLIV				0.25 mA	Class II equipment
35	IEC60745(6)		ENCNEU					

IEC 60598-1 Luminaries - Part 1: General requirements and tests

36	IEC60598(1)	B	ENCLIV	-	-	RMS	0.5 mA	Class 0 and II equipment
37	IEC60598(2)		ENCNEU					
38	IEC60598(3)	C	ENCLIV				1 mA	Class I equipment and mobile luminaire
39	IEC60598(4)		ENCNEU					

IEC 61010-1 Safety requirements for electrical equipment for measurement, control, and laboratory use - Part 1: General requirements

40	IEC61010(1)	B	ENCPE	NORM	NORM	RMS	0.5 mA	
41	IEC61010(2)				FLTNEU		3.5 mA	
42	IEC61010(3)				FLTPE		3.5 mA	

Electrical Appliance and Material Safety Law

43	PSE(1)	D	ENCPE	NORM	NORM	RMS	1 mA	
44	PSE(2)	E						

IEC 61029-1 Safety of transportable motor-operated electric tools - Part 1: General requirements

45	IEC61029(1)	F	ENCLIV	-	-	RMS	0.5 mA	Class 0I equipment
46	IEC61029(2)		ENCNEU					
47	IEC61029(3)		ENCLIV				0.75 mA	Class I instrument
48	IEC61029(4)		ENCNEU					
49	IEC61029(5)		ENCLIV				0.25 mA	Class II equipment
50	IEC61029(6)		ENCNEU					

*1. The "A" has been contained to preset for the product equipped with the firmware version of 1.0x.

Default values of memory numbers 51 to 99

Item A	Setting
Operation mode	TC
NTWK	A
PROBE	ENCPE
POL	NORM
COND	NORM
MODE	RMS
UPPER	30 mA

Item B	Setting
UPPER ON/OFF	ON
LOWER	30 μ A
LOWER ON/OFF	OFF
TIMER	10 s
TIMER ON/OFF	OFF
WAIT	1 s
WAIT ON/OFF	OFF
RANGE	AUTO



System Settings

The system settings consist of the following five screens.

SYSTEM1/5	General settings of the TOS3200
SYSTEM2/5	Measurement check
SYSTEM3/5	Management of the single test result data
SYSTEM4/5	Management of the program test result data
SYSTEM5/5	Time settings and calibration management

You can enter the system setup screen from the 1/2 screen of each operation mode.

To exit from the system setup screen, press the MANUAL or AUTO key to return to the screen of the original operation mode.

Setup Items of SYSTEM1/5





Press the SYSTEM key to display SYSTEM1/5.

On SYSTEM1/5, set the items indicated in the following.

SYSTEM1/5					
1	MEAS MODE	: NORM	BUZ VOL (PASS)	: 3	5
2	PASS HOLD	: 2.0s	BUZ VOL (FAIL)	: 3	6
3	CONV	: OFF	CONTRAST	: 5	7
4	SELV	: OFF	LINE BRK(AUTO)	: ON	8
	MEAS	PASS	CONV	SELV	<NEXT>
					9

Item	Description	Panel operation
1	MEAS MODE	Sets whether to hold the maximum value of the measured values.
	NORM	Normal measurement (not hold the maximum value)
	MAX	Hold the maximum value. Displays the maximum value during the measurement period.
		Rotary knob
2	PASS HOLD	Sets the time to hold the PASS judgment.
	Time	Selectable range: 0.2 s to 10.0 s
	HOLD	Hold until the STOP switch is pressed.
		Rotary knob
3	CONV	Displays the converted measured current based on the specified line voltage. Available in the TC measurement or PCC Measurement Mode.
	Voltage	Selectable range: 80.0 V to 300.0 V
	OFF	Disable the conversion display.
		Rotary knob

Item	Description	Panel operation
4 SELV	Sets the safety extra low voltage (SELV). If the voltage between measurement terminals A and B exceeds the SELV, the DANGER lamp will illuminate. Available in the Meter Mode.	F4 key
	Voltage Selectable range: 10 V to 99 V OFF Disable the SELV check function.	Rotary knob
5 BUZ VOL (PASS)* ¹	Sets the buzzer volume for PASS judgments.	SHIFT+F1 key (Rotary knob)
	Level Selectable range: 0 to 10	
6 BUZ VOL (FAIL)* ¹	Sets the buzzer volume for U-FAIL and L-FAIL judgments and CONTACT FAIL	SHIFT+F2 key (Rotary knob)
	Level Selectable range: 0 to 10	
7 CONTRAST	Sets the screen brightness. You can also use the  (SHIFT+▲) or  (SHIFT+▼) key.	SHIFT+F3 key (Rotary knob)
	Level Selectable range: 0 to 10	
8 LINE BRK (AUTO)	Sets whether or not to supply power to the EUT during program test interval time.	SHIFT+F4 key (rotary knob)
	ON Does not supply power to the EUT during the interval time OFF Supplies power to the EUT during the interval time* ²	
9 <NEXT>	Displays SYSTEM2/5.	F5 key

*1 You can hear the buzzer volume by pressing the BUZ CHK (SHIFT+F5) key when BUZ VOL (PASS) or BUZ VOL (FAIL) is selected.

*2 Even if you set LINE BRK (AUTO) to OFF, the TOS3200 may not supply power to the EUT depending on the step combination.

Setup Items of SYSTEM2/5

See p. 162

On SYSTEM1/5, press the <NEXT> (F5) key to display SYSTEM2/5.

You can execute a measurement check on SYSTEM2/5. The measurement check verifies the operation of the current measurement circuit of the TOS3200. For a description of the measurement check execution, see "Measurement Check".

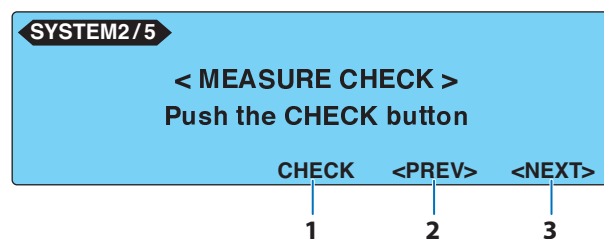

Item	Description	Panel operation
1 CHECK	Executes the measurement check.	F3 key
2 <PREV>	Displays SYSTEM1/5	F4 key
3 <NEXT>	Displays SYSTEM3/5.	F5 key

Setup Items of SYSTEM3/5

On SYSTEM2/5, press the <NEXT> (F5) key to display SYSTEM3/5.
 You can display or delete the stored single test data on SYSTEM3/5.

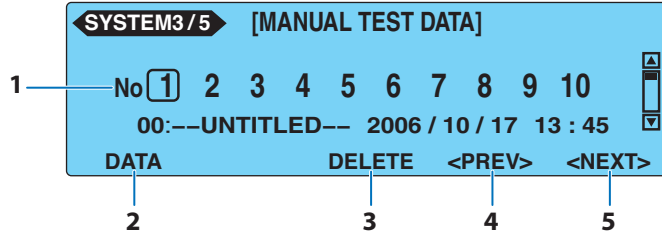

Item	Description	Panel operation
1 No	Specifies the memory number (1 to 50) at which the single test data is stored. If you specify a memory number for the stored data, the saved information will be displayed below the memory number.	◀, ▶, ▲, or ▼ key
2 DATA	Displays the contents of the specified test data. LIST Returns to the single test data list (SYSTEM3/5).	F1 key F1 key
3 DELETE	Deletes the contents of the specified test data. Displayed only when a memory number containing test data is specified.	F3 key
4 <PREV>	Displays SYSTEM2/5.	F4 key
5 <NEXT>	Displays SYSTEM4/5.	F5 key

Setup Items of SYSTEM4/5

On SYSTEM3/5, press the <NEXT> (F5) key to display SYSTEM4/5.
 You can display or delete the stored program test data on SYSTEM4/5.

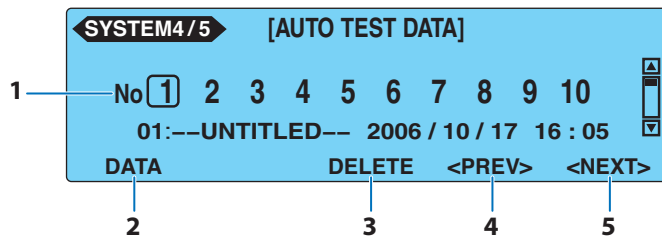

Item	Description	Panel operation
1 No	Specifies the memory number (1 to 50) at which the program test data is stored. If you specify a memory number for the stored data, the saved information will be displayed below the memory number.	◀, ▶, ▲, or ▼ key
2 DATA	Displays the contents of the specified test data. LIST Returns to the program test data list (SYSTEM4/5).	F1 key F1 key

Item	Description	Panel operation
3 DELETE	Deletes the contents of the specified test data. Displayed only when a memory number containing test data is specified.	F3 key
4 <PREV>	Displays SYSTEM3/5.	F4 key
5 <NEXT>	Displays SYSTEM5/5.	F5 key

Setup Items of SYSTEM5/5

On SYSTEM4/5, press the <NEXT> (F5) key to display SYSTEM5/5.

On SYSTEM5/5, set the items indicated in below.

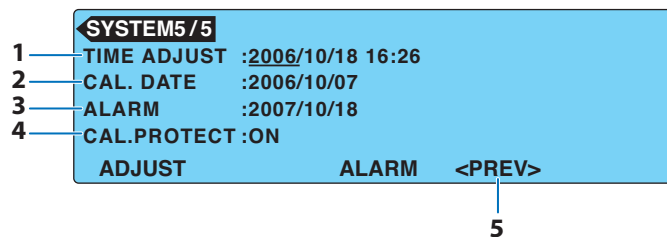

Item	Description	Panel operation
1 TIME ADJUST	Sets the system clock. Enter the present time, and press the ADJUST (F1) key to apply the entered time.	F1 key
	Time Sets the present time. Year/month/day hour:minute	Rotary knob
2 CAL. DATE	Set to the date when calibration service was performed. (You cannot set this date.) Year/month/day	
3 ALARM	Sets the calibration time limit.	F3 key
	Time Sets the next calibration date. Year/month/day	Rotary knob
4 CAL. PROTECT	Sets the action taken when the calibration time limit expires.	
	ON The message "CAL PROTECTION" will blink when the power is turned on if the calibration date is due. You will not be able to use the TOS3200 if "CAL PROTECTION" is displayed. Press the STOP switch to display SYSTEM5/5, and turn CAL. PROTECT off to continue using the TOS3200.	SHIFT+F4 key
OFF The message "CAL DATE EXPIRED" will appear when the power is turned on if the calibration date is due. Press the STOP switch to continue using the TOS3200.		
5 <PREV>	Displays SYSTEM4/5.	F4 key

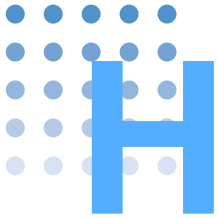

Protection Function

If one or more events occur on the eight items indicated in , the protection circuit will be activated. This is called the protection status, and you cannot use the TOS3200 in this state.

In the protection status, a blinking message will appear on the screen. Release the protection status according to the instructions given in . If the TOS3200 enters the protection status due to multiple events, the protection message of the highest precedence will be displayed.

Order of precedence	Blinking message	Description	Remedy
1	RELAY SHORT PROTECTION	Relay operation error. The operation error may be due to noise.	You can release the protection by pressing the STOP switch. However, if this protection occurs often, the TOS3200 needs to be repaired.
2	CALIBRATION DATA PROTECTION	Error in the calibration data.	This protection cannot be released. The TOS3200 needs to be repaired.
3	OVER LOAD PROTECTION	A current greater than or equal to 15.75 A flowed through the power line to the EUT, or the power is exceeding 1500 VA. The power consumption by the connected EUT is too large, or the EUT power line is shorted.	Disconnect the EUT, and press the STOP switch to release the protection.
4	MEASURE PROTECTION	The result of the measurement check (SYSTEM 2/5) is in error.	If you perform the check again and there is no error, you can continue to use the TOS3200. If the error persists, check that the probe is not broken. If the probe is not broken, the TOS3200 needs to be repaired.
5	BACKUP PROTECTION	Backup error data error.	You can release the protection by pressing the STOP switch. However, some settings may be reset to their default values.
6	OVER RANGE PROTECTION	The measurement range is exceeded.	Press the STOP switch to release the protection.
7	CAL PROTECTION	The calibration data specified by SYSTEM5/5 > ALARM has been surpassed. This protection will occur if SYSTEM5/5 > CAL. PROTECT is set to ON.	Set CAL. PROTECT to OFF and press the STOP switch to release the protection.
8	REMOTE PROTECTION	The enable signal of the SIGNAL I/O connector or that of the REMOTE connector changed.	Press the STOP switch to release the protection.

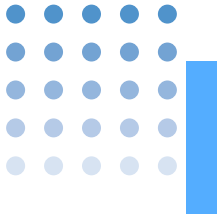

Troubleshooting

This section introduces troubleshooting measures. Typical symptoms are listed. Check whether any of the symptoms below apply to your case. In some cases, the problem can be solved quite easily.

 p. 196

If none of the items apply to your case, we recommend that you initialize the TOS3200 to factory default settings. If the remedy does not solve the problem, contact your Kikusui agent or distributor.

The power does not turn on.

Symptom	Check and Remedy	 Page
The TOS3200 does not operate when the POWER switch is turned on.	<ul style="list-style-type: none"> Is the power cord is connected? Is the power cord connected to the AC inlet for the TOS3200 and not the AC inlet for the EUT? 	27
Power is not supplied to the EUT even if the LINE ON key is pressed.	Is the power input fuse for the EUT blown?	166
	Is power being supplied to the AC inlet for the EUT?	28

The panel does not work properly.

Symptom	Check and Remedy	 Page
It is difficult to view the screen.	Is the screen contrast set low?	36
The test does not start even if the START switch is pressed.	Is a probe connected to the REMOTE connector? Only the START switch of the probe is valid if the probe is connected.	49
	Is a stop signal being applied to the SIGNAL I/O connector? The START switch on the panel is invalid if you are controlling the TOS3200 through the SIGNAL I/O connector.	99
	Is the message "PROTECTION" blinking on the screen? The TOS3200 is in the protection status. See "Protection Function".	204
	Is the EUT power line turned on? Press the LINE ON key to turn the line off.	44
	You cannot start the test from the TC2/2 or PCC2/2 screen.	65
	You cannot start the test while the panel memory is being accessed or while a sequence program is being edited.	34 78
	Is the message "UP<=LOW" shown at the upper right of the screen? Settings in which the lower reference is greater than the upper reference are invalid.	-
Panel key operations are not accepted.	Is the message "KEY LOCK" shown at the lower right of the screen? Release the key lock.	36
	Is the RMT LED illuminated? The TOS3200 is operating via the RS232C, GPIB, or USB interface. To control the TOS3200 from the panel, press the LOCAL key to enable local mode.	-
The TOS3200 does not switch to local mode even when I press the LOCAL key.	Was a local lockout (LLO) command sent via the communication interface? Use a communication command to clear the LLO command.	149

Unable to make correct measurements.

Symptom	Check and Remedy	 Page
The measured values are not correct.	<ul style="list-style-type: none"> Is the test lead connected to the correct terminal? Connect a test lead to the measurement terminal for which the LED is illuminated. 	45
	<ul style="list-style-type: none"> Is the measurement network that you are using correct? Use the measurement network required by the standard to make the measurement. 	–
	<ul style="list-style-type: none"> Is the CONV function turned on? Turn CONV off to determine the measured values at the power voltage supplied to the EUT. 	61
	<ul style="list-style-type: none"> Is WAIT turned OFF? If you do not measure the EUT data at startup, turn WAIT on and set an appropriate time. 	51
	<ul style="list-style-type: none"> If the power cord of the EUT is a two-prong cord with a ground wire, is the ground line connected to a ground terminal? 	42
	<ul style="list-style-type: none"> Is the EUT connected to both the plug on the front panel and the terminal block on the rear panel? 	–
The measured values are not updated.	<ul style="list-style-type: none"> Is the TOS3200 set to hold the measured value? If MEAS MODE is set to MAX in Meter Mode, press the MAXCLR (F4) key to clear the held, measured value. 	72
Unable to save the test data when the judgment is PASS.	<ul style="list-style-type: none"> Is the PASS hold time too short? 	60
The test does not stop.	<ul style="list-style-type: none"> Is the timer turned off? The specified test time is not enabled. Turn the timer on. 	–
The program test does not stop.	<ul style="list-style-type: none"> Is there a step in which the timer is turned off? The program will advance to the next step only if U-FAIL or CONTACT FAIL occurs for steps whose timer is turned off. Turn the timer on. 	–
The test does not stop even if the judgment is FAIL in the middle of a program test.	<ul style="list-style-type: none"> Is ABORT turned off? Turn ABORT on if you want to stop the test on a FAIL judgment at the step level. 	82
The time when the test data was saved is not correct.	<ul style="list-style-type: none"> Is the system clock correct? Set the system clock to the present time. 	164

Unable to control the TOS3200 remotely through the RS232C.

Symptom	Check and Remedy	 Page
Unable to control the TOS3200 from the PC.	<ul style="list-style-type: none"> Is the talk mode turned on? Turn talk mode off to control the TOS3200 from a PC. 	106
	<ul style="list-style-type: none"> Are you using a cross cable? 	104

INDEX

A	
ABORT	92
AC LINE OUT	42
accessories	24
AUTO1/2	78
AUTO2/2	82
B	
BACKUP PROTECTION	204
body impedance network	185
boolean data	112
BUZ VOL	61, 87, 201
C	
CAL DATE EXPIRED	164
CAL PROTECTION	204
CALIBRATION DATA PROTECTION	204
calibration time limit	164
CAT II	5
character data	112
character string data	112
Check	162
Command	
description	114
hierarchy	110
processing time	195
syntax	110
unit	113
Common commands	112, 115
CONDition register	150
CONV	61, 87, 200
Converted Display of the Measured Current	61, 87
D	
data, deletion of	68, 94
E	
Earth Continuity Test	183
Earthing check	53
ENABLE register	150
EUT, checking the operation of	44
EVENT register	150
event status register	153
F	
firmware version	2, 29
Flat Probe	48
FP01-TOS	48
Fuse	166
G	
GPIO Interface	107
H	
HP21-TOS	49
I	
I/O library	103
IEEE Std 488.2	102
initialization	196
Insulation Resistance Test	182
interface	102
interval	77, 89
J	
judgment	50
Judgment for each step	92
K	
KEY LOCK	36
KI-VISA	103
L	
Leakage Current Test	184
L-FAIL	50
LINE BRK (AUTO)	88, 201
LINE ON key	44
List of Default Settings	196
List of Errors	192
Lithium battery for backup	166
M	
MEAS MODE	60, 86, 200
MEASURE CHECK	201
MEASURE PROTECTION	204
measurement category II	5
Measurement Check	162, 201
measurement network	176
Messages	110
List	186
meter mode measurement screen 1/2	72
meter mode measurement screen 2/2	73
METER1/2	72
METER2/2	73
multi outlet	21, 43
N	
NRf	113
NTWK	176
Numeric	113
O	
OPERation status register	154
options	20
OT01-TOS	43
outline drawing	175, 176
OVER LOAD PROTECTION	204
OVER RANGE PROTECTION	204
P	
palm	48
Panel memory	38, 198
parameter	112

PASS	50
PASS HOLD	60, 86, 200
PCC measurement screen 1/2	56
PCC measurement screen 2/2	59
PCC1/2	56
PCC2/2	59
POWER	29
power cord	27
power, turning on	29
Program edit screen 2/2	82
program test screen 1/2	78
PROTECTION	204
protection status	204
protective conductor current	184

Q

query	111
QUEStionable status register	156

R

rack mount adapter	20
RELAY SHORT PROTECTION	204
Remote control	
List of Errors	192
remote interface	102
REMOTE PROTECTION	204
RS232C Interface	104
RS232C protocol	106

S

safety extra low voltage	73, 201
SCPI	102, 110
screen brightness	36
SELV	73, 201
sequence program	76
SIGNAL I/O connector	96
single test	37
Stand	26
Starting the Test	62, 88
status byte register	152
Status Register	150
Step	76
Default values	78
Deleting	79
insertion	78, 79
Stopping the Test	66, 91
system clock	164, 203
system setup screen	200
SYSTEM1/5	200
SYSTEM2/5	201
SYSTEM3/5	202
SYSTEM4/5	202
SYSTEM5/5	203

T

talk mode	106
TC measurement screen 1/2	52
TC measurement screen 2/2	55
TC1/2	52
TC2/2	55
terminator	112
test leads	45, 71
Test Probe	20, 49
test results, display of	68, 94

test results, storage of	67, 93
Test Wait Time	51
TL21-TOS	45, 71
total judgment	92
touch current	184
transition filter	150
troubleshooting	205
Tutorial	158

U

U-FAIL	50
USB Interface	109

V

version	2
VISA library	103

W

warm-up time	168
Withstanding Voltage Test	181