



close up of nanocalorimeter chips on TO-5 header

1 INTRODUCTION	2
1.1 About this Application Note	2
1.2 Short description	2
2 BACKGROUND INFORMATION	3
2.1 Introduction	3
2.2 Technology	3
2.3 (Ultra)-Fast Scanning Calorimetry	5
2.4 Ultra-fast Scanning Calorimetry	5
3 TECHNICAL DATA	6
3.1 Specials	6
3.2 Specifications	7
4 OVERVIEW OF THE DEVICES	9
4.1 General overview	9
4.2 XEN-TCG3880: the old, non-dedicated device	10
4.3 XEN-39393 + XEN-39394: Ultra fast calorimeter chips	11
4.4 XEN-39390: Smaller-area calorimeter chip	12
4.5 XEN-39391: Medium-area calorimeter chips	12
4.6 XEN-39392 + XEN-39399: Larger-area calorimeter chips	13
4.7 XEN-39397 + XEN-39398: Large-area calorimeter chips	14
4.8 XEN-39395	14
5 HOUSINGS AND PINNING	16
5.1 Housings	16
5.2 Pinning	17

1 Introduction

1.1 About this Application Note

This Application Note is intended to help the users of Thin Film Calorimeter chips for use in gases and interface electronics with the set-up and execution of their experiments. It will give some theoretical background information, practical guidelines, specific applications and references to the work of other users.

The Application Note is by no means exhaustive. This means, that if you miss something and have questions, or if you have useful information or interesting applications that you want to share, we highly appreciate your contribution to improving this note.

1.2 Short description

Introduction

There are two types of nanocalorimeter chips available from RS Product Solutions, those based on thicker monocrystalline silicon membranes and those based on thin silicon-nitride membranes.

The first types have low thermal isolation, but are very robust, they are well suited for use in liquid and slow applications (XEN-LCM2506, XEN-LCMquad, XEN-NCM9924). They are described in the "Nano cals" document.

The types based on SiN membranes of about 1 μm thickness are described in this document. They are fragile but very well isolated and fast, and therefore more suited for application in gaseous environments and for fast measurements, such as Fast Scanning Calorimetry. All the chips described in this document have outside dimensions of 3.33 \times 2.50 mm, and are 0.3 mm thick, with the exception of the XEN-39397, which is 5.0 \times 3.3 mm large.

Below we will first give some background information on the thin film calorimeter chips and Fast Scanning Calorimetry. Then we will give technical data on the various devices available, and give photos and some details on the devices.

2 Background information

2.1 Introduction

The science of calorimetry is more than 200 years old. Since then, many calorimetric instruments have been devised and refined. In the last decades, improving technology has been enabling, but also demanding, that calorimetry becomes smaller, faster, more accurate. For the analysis of very thin films and particles, measured in micrometers and even nanometers, weighed in micrograms or nanograms, even the most refined DSC instruments simply are not adequate anymore. The same holds for the high-speed calorimetric analysis. The speed of production processes is ever increasing to reduce costs. The speed of calorimetric analysis has to keep up, and where DSC rate of heating and cooling is measured in K/min, some applications really require speeds expressed in kK/sec.

The silicon technology used to make computer chips also makes it possible to make different chips, which will actually work as calorimeters, measuring nanogram samples at speeds up to 1 MK/s. The secret is to make everything small, especially the heated volumes. This makes it easier to examine minute samples, and to heat and cool at incredible rates.

2.2 Technology

While a lot of work has been done on chip calorimeters with mono-crystalline silicon membranes (technological cross-section shown in Fig. 2.1a), more work has been done on chip calorimeters with dielectric membranes. Here, a membrane based on a low-stress silicon-nitride layer is preferred, because of the excellent mechanical properties of such a layer and its relatively low thermal conductivity. Usually, this silicon-rich SiN layer is best characterized by its refractive index, which is towards 2.2, and a stoichiometric ratio of Si versus N of 0.9 approximately, where 0.75 is the normal ratio. For convenience, this layer is designated as SiN. The technology of such a device is shown in Fig. 2.1b. The low thermal conductivity of the SiN, together with its smaller thickness, makes that the membrane thermal resistance between the middle and the silicon frame is now routinely of the order of 5-50 kK/W in vacuum, compared to a few hundred K/W for the mono-Si closed membranes. This enables us to detect much smaller heat effects.

However, in order not to spoil the high thermal resistance, thermopiles are usually less sensitive in these devices at 1-5 mV/K. So, the overall sensitivity in air is then of the order of 10-100 V/W, about one order of magnitude higher than for silicon-membrane chips.

Thin-film membrane chips have also been tried out in liquid applications, but for this other designs are required, they are not discussed here. For dry applications, the thin dielectric membranes are especially suitable. There are many dry applications, for chemical sensing, for measurement of the thermal and thermoelectric properties of CMOS-process layers, for materials research and magnetic properties of thin films, and, for high-speed scanning calorimetric applications in general.

The design XI-200 / XEN-TCG3880, and to some extent its predecessor, XI-120 / XEN-TCG3575, have been widely used for calorimetry. These chips were designed for quite another application, the measurement of the thermal conductivity of a gas. Therefore, some features were optimized for this application, which has an adverse effect on the calorimetric performance. In particular, the heater is effectively formed by two strips of about $100 \times 5 \mu\text{m}$, separated $50 \mu\text{m}$, and the thermocouple hot junctions are located some 50-100 μm away from the heater strips, see Figs. 2.2 & 2.3.

This leads to a much lower temperature at the hot junctions of the thermopile, compared to that of the heater, the difference can be many tens of percents. Therefore, in order to obtain proper results, extensive modeling has to be performed. Especially the group of Schick has done a lot of work in this area, see his website for many publications.

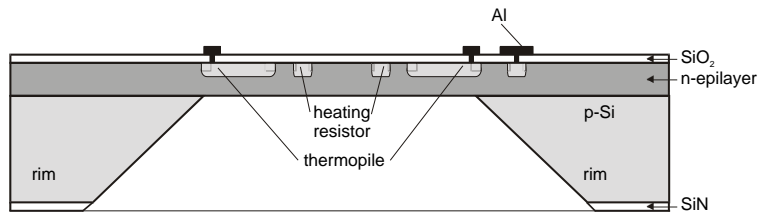

(a)

Figure 2.1 Some technologies to fabricate chip calorimeters:

a) mono-crystalline Si membrane ($2\frac{1}{2}$ - $40\ \mu\text{m}$ thick) with mono-Si heating resistors and mono-Si/Al thermopile;

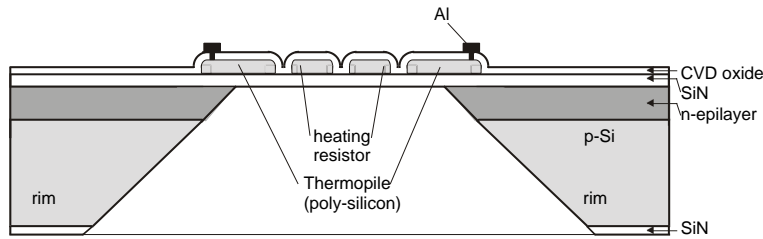

(b)

b) SiN membrane with poly-Si heater and thermopile;

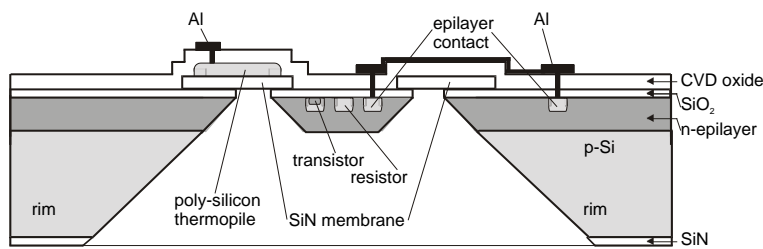

(c)

c) combined mono-Si/SiN membrane process [7], with poly-Si thermopiles and heaters, and heaters, diodes and transistors in the mono-Si island.

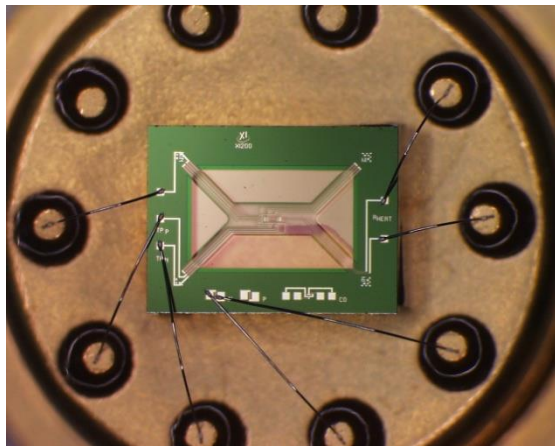

Figure 2.2 XI-200 chip on a TO-5 header, forming the XEN-TCG3880.

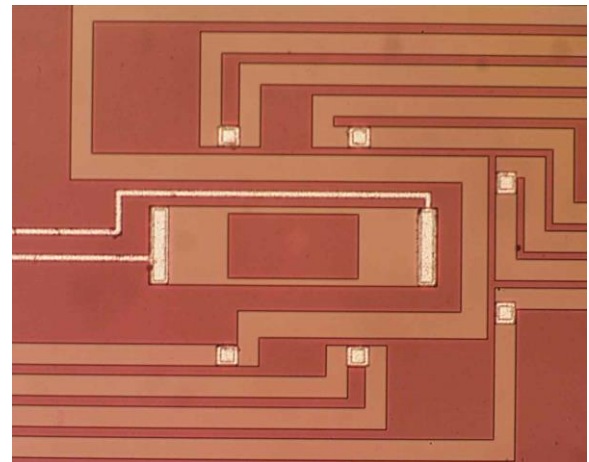

Figure 2.3 Close-up of the center of the XI-200 chip.

2.3 (Ultra)-Fast Scanning Calorimetry

As mentioned above, the silicon-nitride membrane chips, which are characterized by a high thermal resistance to the ambient, have a very small time constant. This makes these sensors particularly suited for measurements in gaseous environments on small samples with high temperature scanning rates. Temperature scan rates (cooling as well as heating) of more than 1 MK/sec have been obtained by Alexander Minakov of the group of Prof. Schick at Rostock University with the XEN-39273, see Fig. 2.4. Thus, in some milliseconds, a complete measurement is carried out. Here typical temperature ranges are from 4 K up to 450 K for the frame, while the membrane center, with the sample, can go up to 800 K for very short periods of time. The maximum temperature difference between frame and center of the membrane has to be limited, though, as the thermal expansion may cause mechanical problems. A difference of 500 K is usually the maximum that can be tolerated. Thus, the range of these sensors comes closer to that of basic calorimeter instruments.

2.4 Ultra-fast Scanning Calorimetry

At the University of Rostock, Alexander Minakov has performed some ultra-fast scanning calorimetry using the XEN-39273. The Fig.2.4 shows the very first experimental data.

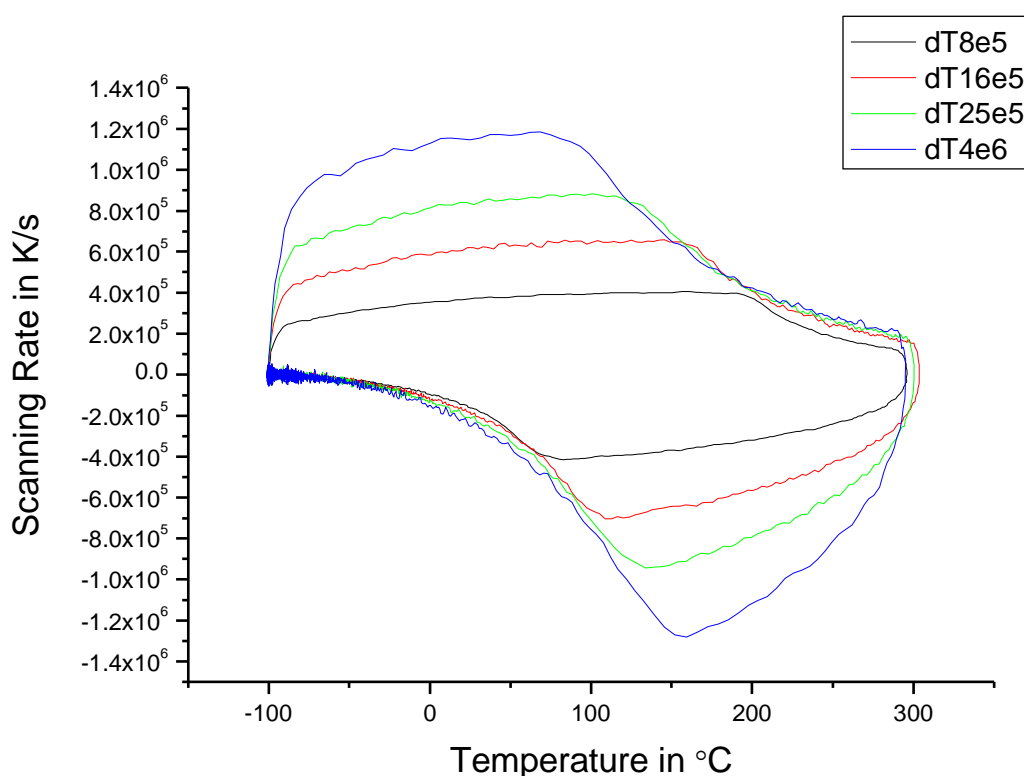

Figure 2.4 Critical rates (from 0.5 to 1 million K/s) at least suitable for thermal treatments. The measurements were performed in N_2 . The data are preliminary. The temperature scale will be corrected.

3 Technical data

3.1 Specials

The chips described here are used extensively for scientific experiments. Many of our customers have special wishes for special experiments. Many of these wishes can be discussed, and often solutions are found enabling novel experiments. If you have an idea please contact us.

But to give some examples, some specials are listed below.

- special housings, such as ceramic plates with holes to allow through-light, or ceramic plates for AFM. Ceramic Housings: series XEN-40000. See separate datasheet.
- non-magnetic housings such as LCC-20 non magnetic for magnetic experiments.
- special glues for extended temperature range or increased thermal conductivity.
- naked die for mounting on your own housing.
- TO-5 sockets with (or without) small PCB for easy and convenient connection.

Gas Nanocalorimeters **XEN-39390** series

3.2 Specifications

Table 3.1 Specifications (ambient temperature 22 °C, air, 1013 mbar).

Parameter	XEN-39393	XEN-39395	XEN-39390	XEN-39391	XEN-39392	unit	symbol	notes
	XEN-39394				XEN-39399			
Dimensions								
chip dimensions	→	→	3.3x2.5x0.	←	←	mm ²		
membrane size	→	→	0.9x0.9	←	←	mm ²		
membrane thickness	→	→	1	←	←	μm		
Output	22	75	55	46	40	V/W	S	
Time constant	1		2	4	4	ms	τ	
Cooling rate	1					MK/s	τ	
Effective Heat capacity	20		60	140	180	nJ/K	C (=τ/R _{th})	
P-P-noise equiv. Power	200		150	170	210	nW		1 kHz sampling
Thermopile								
resistance	7	32	30	30	29	kΩ	R _{tp}	
sensitivity*	0.35	2.0	2.0	2.0	2.0	mV/K	S _{tp}	at 273 K
temp coefficient	0.05	0.05	0.05	0.05	0.05	%/K		
Heater								
bias (inner) resistance	0.8	0.9	0.7	1.15	1.7	kΩ	R _{heat}	
guard resistance	-	-	1.2	1.75	2.3	kΩ	R _{guard}	
temperature coefficient	→	→	0.1	←	←	%/K		
Thermal resistance							R _{th} (=S/S _{tp})	
membrane + gas	66	38	28	29	20	kK/W		
temperature coefficient	-0.15	-0.15	-0.15	-0.15	-0.15	%/K		estimate
Maximum heating	2.5	2	5	6	8	V	U _{heat}	
Sensor ambient temp								
minimum	→	→	-40	←	←	°C		
maximum	→	→	85	←	←	°C		
Heater max temp								
long term (days)	→	→	250	←	←	°C		
short term (seconds)	→	→	500	←	←	°C		

Data in italics are estimated

- A preliminary approximation for the thermocouple sensitivity is 330 μV/K + 0.5×T μV/K (T in °C, -50 °C to +180 °C)

Gas Nanocalorimeters XEN-39390 series

Table 3.1 Specifications (ambient temperature 22 °C, in air at 1013 mbar).

Parameter	XEN-39397		XEN-39398		unit	symbol	notes
	typ	typ	typ	typ			
Dimensions							
chip dimensions	5.0×3.3×0.3	3.3×2.5×0.			mm ²		
membrane size	2.4×2.0	0.9×0.9			mm ²		
membrane thickness	1	1			μm		
Output	23	23			V/W	S	
Time constant	13	3			ms	τ	
Cooling rate					MK/s		
Effective Heat capacity	4000	250			nJ/K	$C (=τ/R_{th})$	
P-P-noise equiv. Power					nW		1 kHz sampling
Thermopile							
resistance	83	23			kΩ	R_{tp}	
sensitivity*	7.0	2.0			mV/K	S_{tp}	at 273 K
temp coefficient	0.05	0.05			%/K		
Heater							
bias (inner) resistance	4	3			kΩ	R_{heat}	
guard resistance	-	3.6			kΩ	R_{guard}	
temperature coefficient	0.1	0.1			%/K		
Thermal resistance						$R_{th} (=S/S_{tp})$	
membrane + gas	3.3	11			kK/W		
temperature coefficient	-0.15	-0.15			%/K		estimate
Maximum heating voltage	16	8			V	U_{heat}	
Sensor ambient temp							
minimum	-40	-40			°C		
maximum	85	85			°C		
Heater max temp							
long term (days)	250	250			°C		
short term (seconds)	500	500			°C		

Data in italics are estimated

- A preliminary approximation for the thermocouple sensitivity is $330 \mu\text{V/K} + 0.5 \times T \mu\text{V/K}$ (T in °C, -50 °C to +180 °C)

4 Overview of the devices

4.1 General overview

The use of Fast Scanning Calorimeter chips from Xensor Integration started with Prof. Schick's group from the University of Rostock in fast calorimetry experiments with heating and cooling rates in excess of 10 kK/s. using the XEN-TCG3880 on a TO-5 header. After this, new devices have been developed for the FSC application, enabling more accurate temperature measurement than the XEN-TCG3880 allows. Table 4.1 gives an overview of the currently available devices, some of the older devices, if not replaced by a new device, may still be available until sold out.

Table 4.1 Calorimeter chips with different hot spot areas.

Present Device	Replaces	Hot Spot ($\mu\text{m}\times\mu\text{m}$)	Thermopile sensitivity (mV/K) estimated value at 300 K
	XEN-TCG3880	50 \times 100	2.0
	XEN-39269	14 \times 14	1.3
	XEN-39276 @	46 \times 46	1.3
XEN-39390	XEN-39270, XEN-39320	30 \times 30	2.0
	XEN-39277 @	62 \times 62	2.0
XEN-39391	XEN-39271	60 \times 60	2.0
	XEN-39278 @	92 \times 92	2.0
XEN-39392	XEN-39272	100 \times 100	2.0
XEN-39399©	XEN-39279 @	100 \times 100	2.0
XEN-39393	XEN-39292	8 \times 14	0.35
XEN-39394		8 \times 10	0.35
XEN-39395	XI-240, XEN-39295	60 \times 70	2.0
XEN-39397	XEN-39347	1000 \times 1000	7.0
XEN-39398©		250 \times 250	2.0

@ with aluminum-coated hot spot

© with polysilicon-coated hot spot

4.2 XEN-TCG3880: the old, non-dedicated device

For Fast Scanning Calorimetry, in which heating rates and cooling rates are not measured in Kelvin/minute, but in kiloKelvin/second or even faster, you want to have as little mass to heat and (more difficult) to cool, thin membranes therefore. The XEN-TCG3880 has been used extensively by Schick et al from the University of Rostock in fast calorimetry experiments with heating and cooling rates in excess of 10 kK/s.

This chip is from the old generation, not designed for calorimetry and difficult to obtain quantitative data with. For comparison with previous experiments it can be useful, but the new line of chips listed below is recommended.

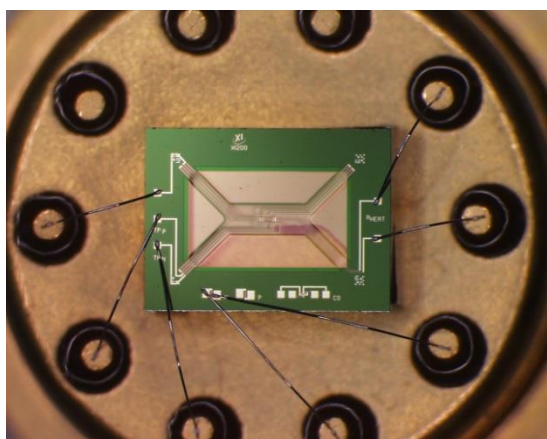

Figure 4.1 XI-200 chip on a TO-5 header, forming the XEN-TCG3880.

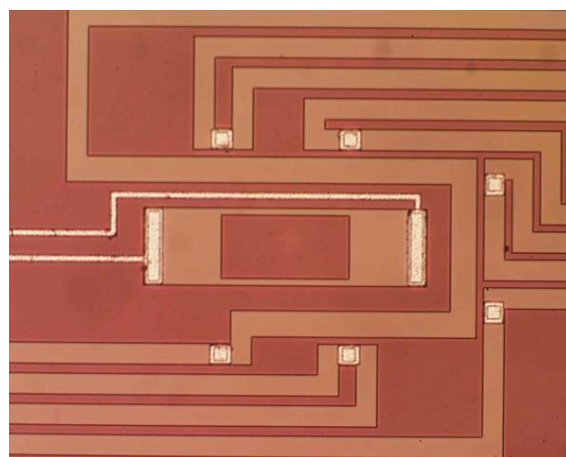

Figure 4.2 Close-up of center of XI-200 chip, showing the central heater and the hot junctions (6× Al dot) of the p-n poly-Si thermopile.

4.3 XEN-39393 + XEN-39394: Ultra fast calorimeter chips

These are two chips designed for speed. The hot spot area is only $14 \times 8 \mu\text{m}$ and $10 \times 8 \mu\text{m}$ large, the thermopile consists of only 1 polysilicon p-n couple. With a time constant in air of about 1 ms, the maximum cooling and heating rate is of the order of 1 MK/s .

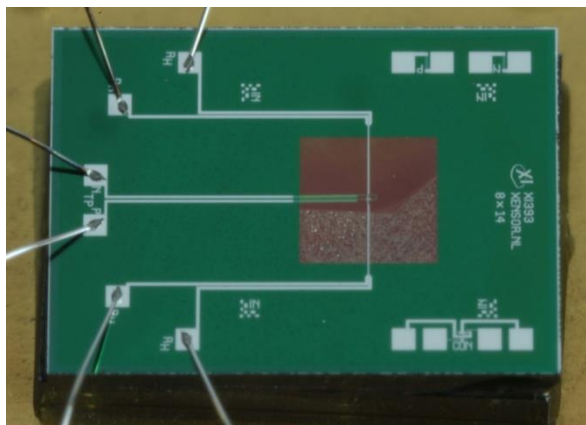

Figure 4.3 XEN-39393 chip, 3.3x2.5 mm.

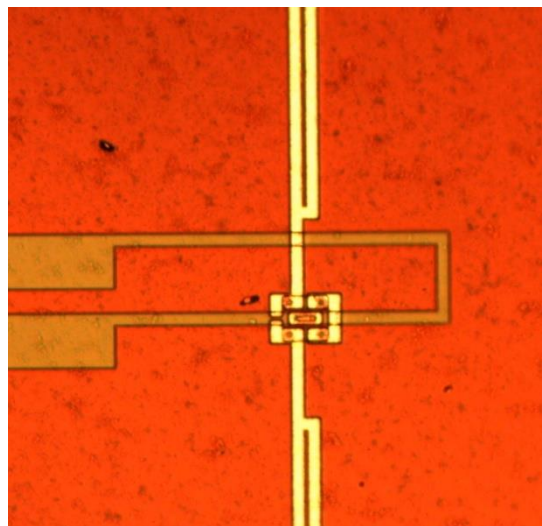

Figure 4.4 Close up of center of XEN-39393 chip.

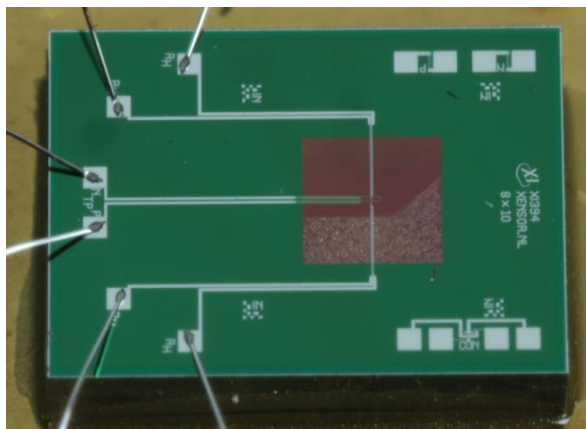

Figure 4.5 XEN-39394 chip, 3.3x2.5 mm.

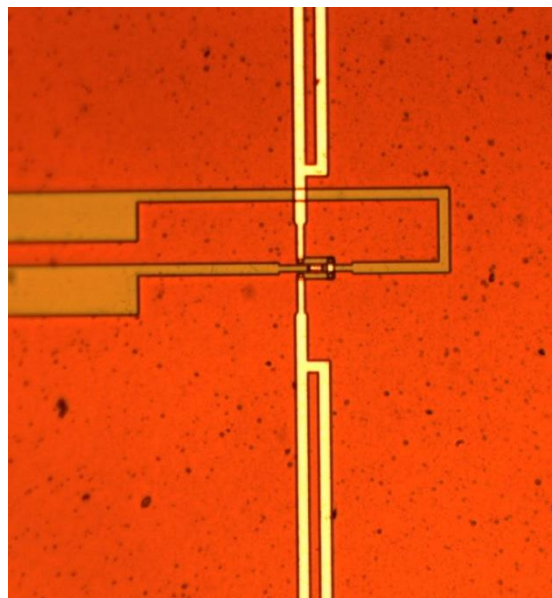

Figure 4.6 Close up of center of XEN-39394 chip.

4.4 XEN-39390: Smaller-area calorimeter chip

This is a smaller sized hot spot area nanocalorimeter chip, with a hot spot area of about $30 \times 30 \mu\text{m}$, featuring a 6-couple thermopile within two 4-wire heaters (bias and guard heater). It replaces the XEN-39270 and XEN-39320, which are virtually identical, but have a different pin-out on the TO-5 header.

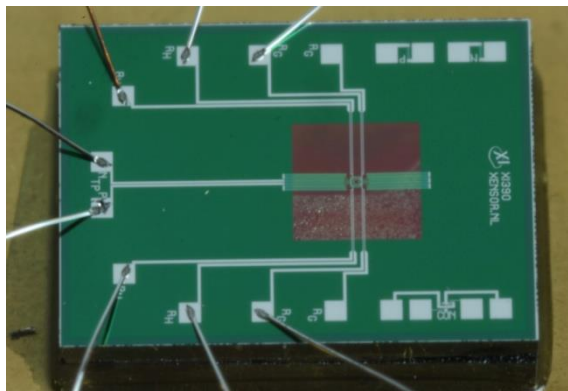

Figure 4.7 XEN-39390 chip, 3.3x2.5 mm.

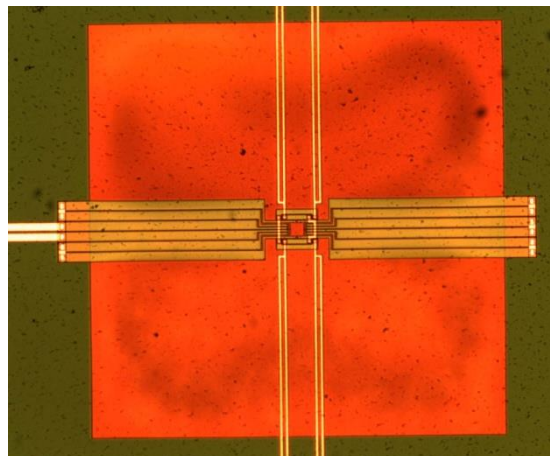

Figure 4.8 Close up of center of XEN-39390 chip.

4.5 XEN-39391: Medium-area calorimeter chips

This is a medium sized hot spot area nanocalorimeter chip, with a hot spot area of about $60 \times 60 \mu\text{m}$, featuring a 6-couple thermopile within two 4-wire heaters (bias and guard heater). It replaces the XEN-39271 and XEN-39321, which are virtually identical, but have a different pin-out on the TO-5 header.

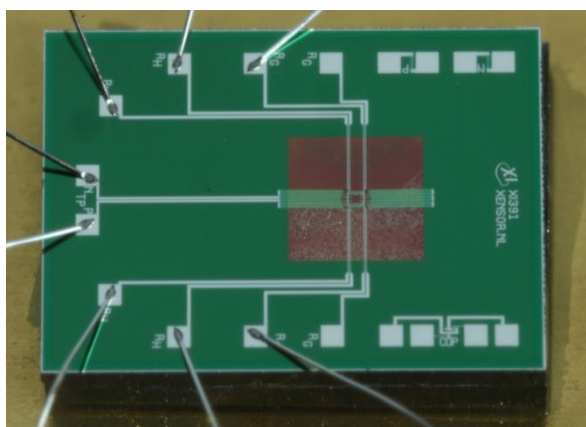

Figure 4.9 XEN-39391 chip, 3.3x2.5 mm.

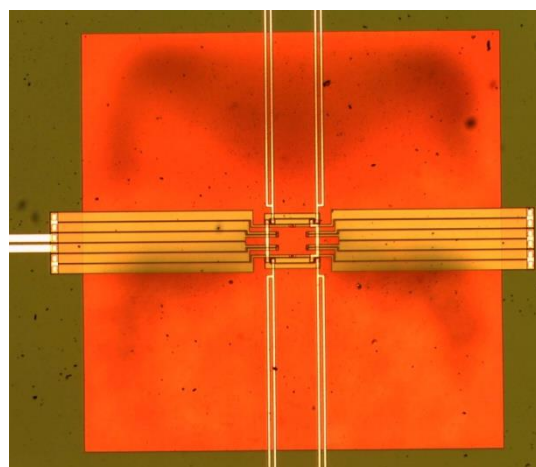

Figure 4.10 Close up of center of XEN-39391 chip.

4.6 XEN-39392 + XEN-39399: Larger-area calorimeter chips

These are larger sized hot spot area nanocalorimeter chips, with a hot spot area of about $100 \times 100 \mu\text{m}$, featuring a 6-couple thermopile within two 4-wire heaters (bias and guard heater). The XEN-39399 has a poly-silicon-covered hot spot area for improved temperature homogeneity, otherwise it is identical to the XEN-39392.

The XEN-39392 replaces the XEN-39272 and XEN-39322, which are virtually identical, but have a different pin-out on the TO-5 header. The XEN-39399 replaces the XEN-39279, where the aluminum coating on the hotplate has been replaced by a poly-coating, to reduce addenda and make the chip transparent for light, here too there is a different pin-out on the TO-5 header.

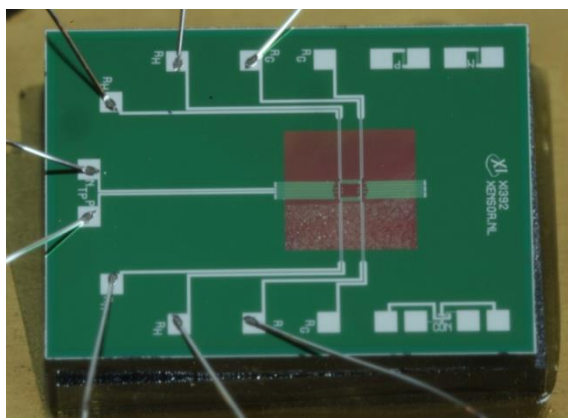

Figure 4.11 XEN-39392 chip, 3.3x2.5 mm.

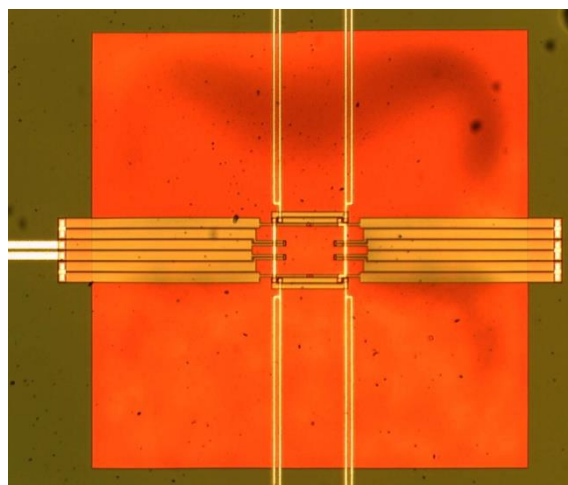

Figure 4.12 Close up of center of XEN-39392 chip.

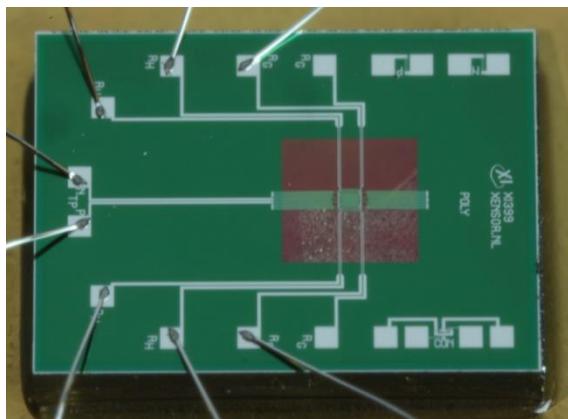

Figure 4.13 XEN-39399 chip, 3.3x2.5 mm.

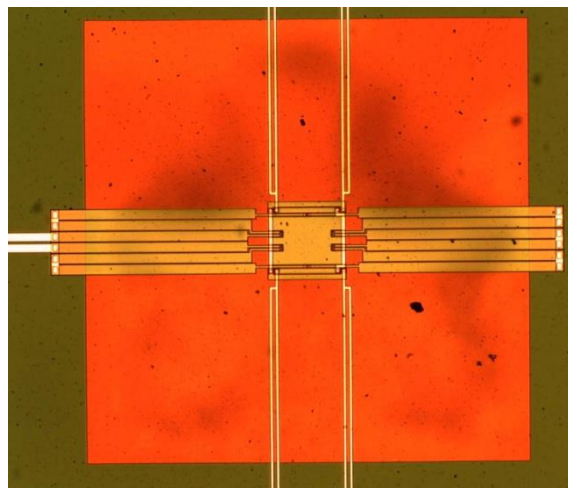

Figure 4.14 Close up of center of XEN-39399 chip, with poly silicon in the hot spot area.

4.7 XEN-39397 + XEN-39398: Large-area calorimeter chips

These are the largest sized hot spot area nanocalorimeter chips. The XEN-39398 has double, 4-wire heaters, with a hot spot area of about $250 \times 250 \mu\text{m}$, featuring a 6-couple thermopile within two 4-wire heaters (bias and guard heater). The hot spot is covered with polysilicon for improved temperature homogeneity.

The XEN-39397 has a single, 4-wire heater and a 20-couple thermopile, the hot spot area is aluminum-covered for improved temperature homogeneity.

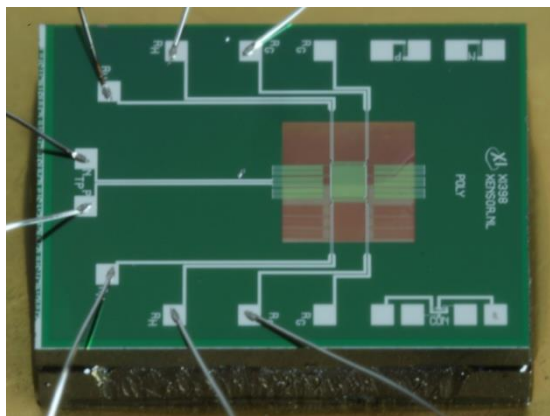

Figure 4.15 XEN-39398 chip, 3.3x2.5 mm.

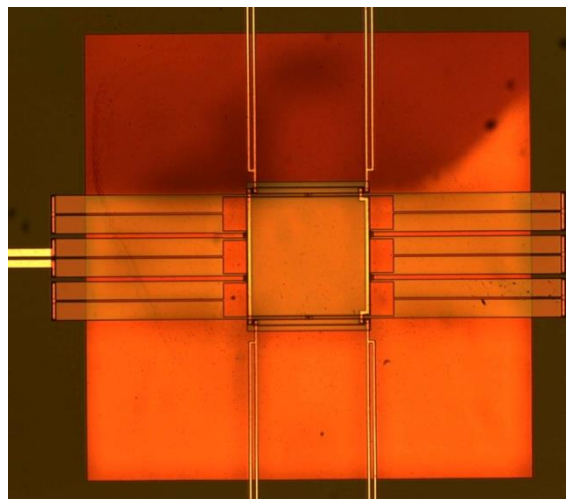

Figure 4.16 Close up of center of XEN-39398 chip.

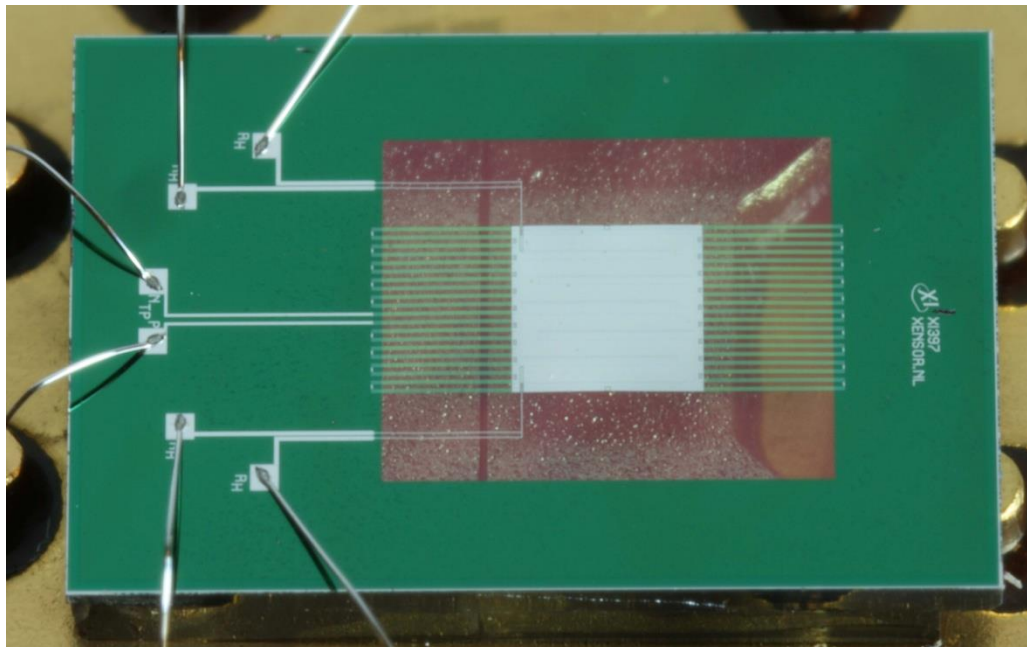

Figure 4.17 XEN-39397 chip, 5.0x3.3 mm.

4.8 XEN-39395

The XEN-39395 is the replacement of earlier designs, XI-240 and XEN-39295, with a 6-couple thermopile and a single heater, 4-wire from the frame of the chip onwards.

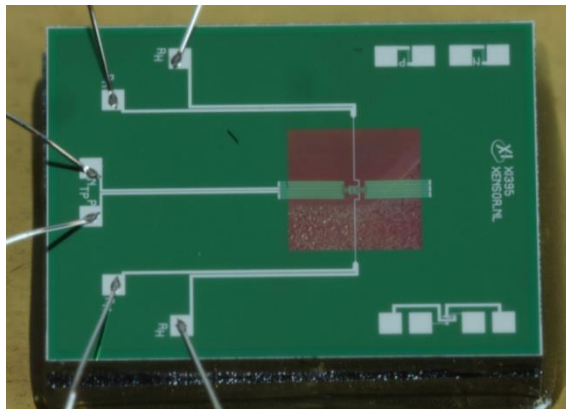

Figure 4.18 XEN-39395 chip, 3.3x2.5 mm.

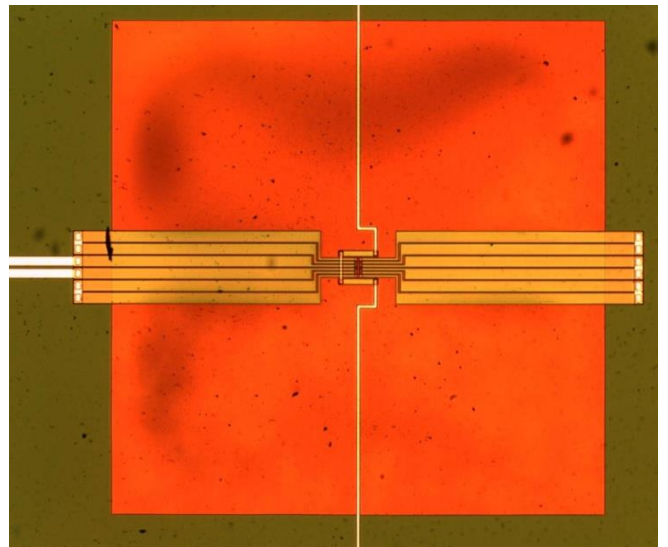

Figure 4.19 Close up of XEN-39395 chip.

5 Housings and pinning

5.1 Housings

XEN-39273 on TO-5 10 pin and XEN-39272 in LCC-20 non-magnetic

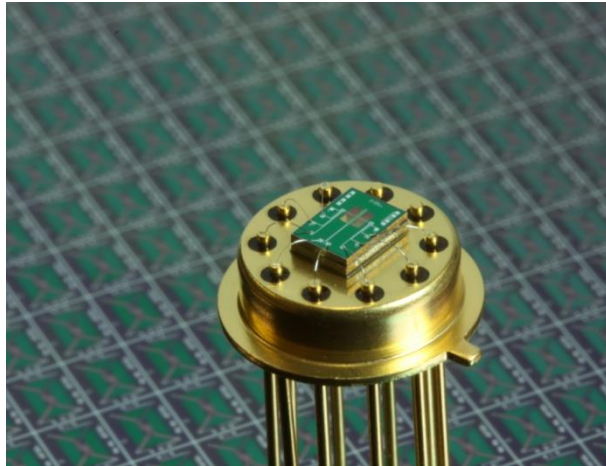

Figure 5.1 XEN-39.. on TO-5.

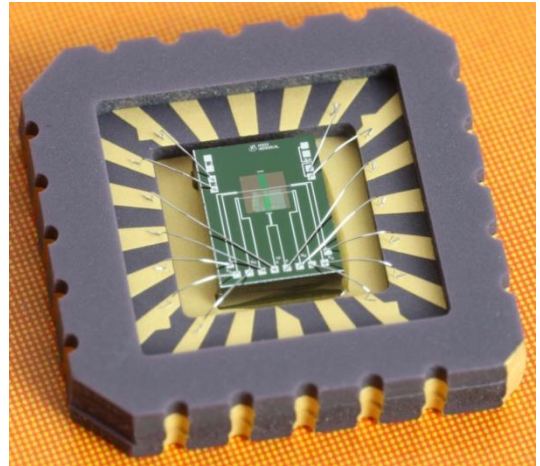

Figure 5.2 XEN-3939. in LCC-20 n.m.

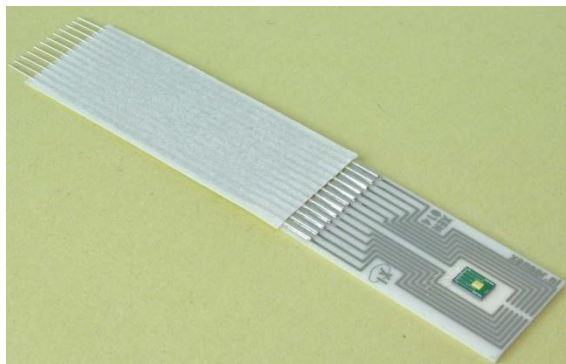

Figure 5.3: XEN-3939. on XEN-40014 ceramic (24x12 mm).

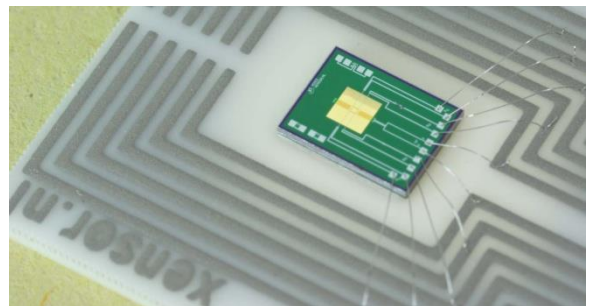
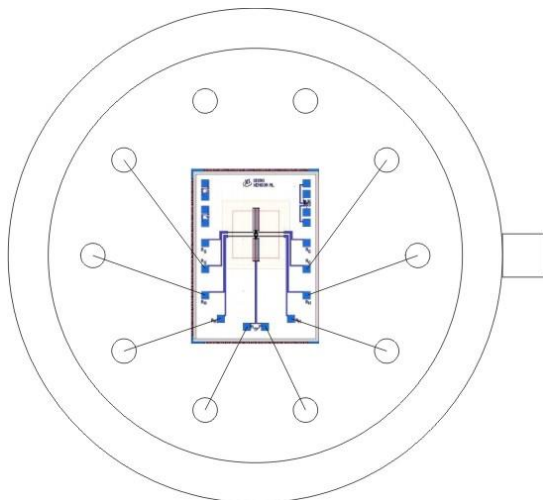

Figure 5.4: XEN-3939. on XEN-40014 ceramic (24x12 mm). detail

5.2 Pinning



- pin (counter clockwise)
- 1 R_{heat} (+)
 - 2 R_{guard} (+)
 - 3 nc
 - 4 nc
 - 5 R_{guard} (-)
 - 6 R_{heat} (-)
 - 7 R_{heat} (-)
 - 8 Out (-)
 - 9 Out (+)
 - 10 R_{heat} (+)

Figure 5.5 XEN-39390 8 wires on TO-5 10 pin.

Designs: XI-390 t/m XI-392 + XI-398 t/m XI-399.

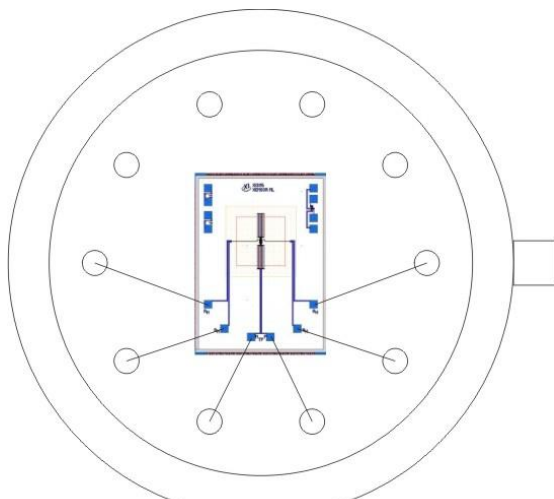

- pin (counter clockwise)
- 1 R_{heat} (+)
 - 2 nc
 - 3 nc
 - 4 nc
 - 5 nc
 - 6 R_{heat} (-)
 - 7 R_{heat} (-)
 - 8 Out (-)
 - 9 Out (+)
 - 10 R_{heat} (+)

Figure 5.6 XEN-39395 6 wires on TO-5 10 pin.

Designs: XI-393 t/m XI-395.

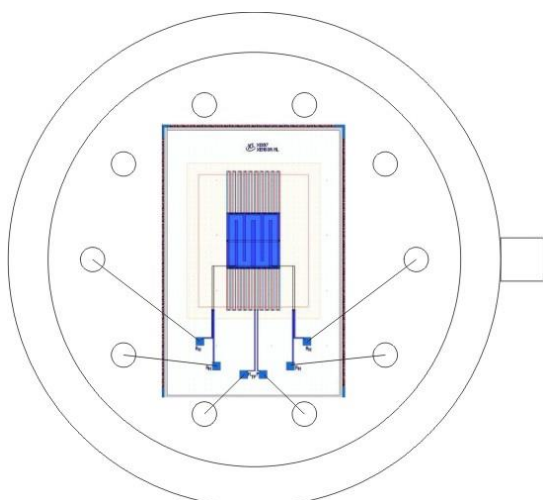

- pin (counter clockwise)
- 1 R_{heat} (+)
 - 2 nc
 - 3 nc
 - 4 nc
 - 5 nc
 - 6 R_{heat} (-)
 - 7 R_{heat} (-)
 - 8 Out (-)
 - 9 Out (+)
 - 10 R_{heat} (+)

Figure 5.7 XEN-39397 6 wires on TO-5 10 pin.

Designs: XI-397.

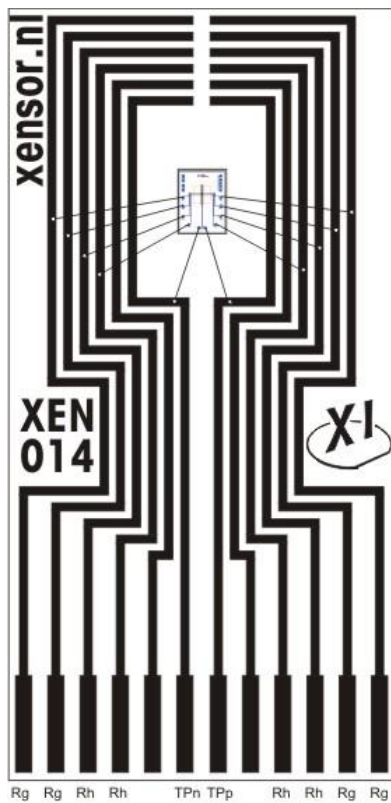

Figure 5.8 XEN-39390 on XEN-40014.

pin (left to right)

- 1 R_{guard} (-)
- 2 R_{guard} (-)
- 3 R_{heat} (-)
- 4 R_{heat} (-)
- 5 nc
- 6 Out (-)
- 7 Out (+)
- 8 nc
- 9 R_{heat} (+)
- 10 R_{heat} (+)
- 11 R_{guard} (+)
- 12 R_{guard} (+)

Designs: XI-390 t/m XI-392 + XI-398 t/m XI-399.

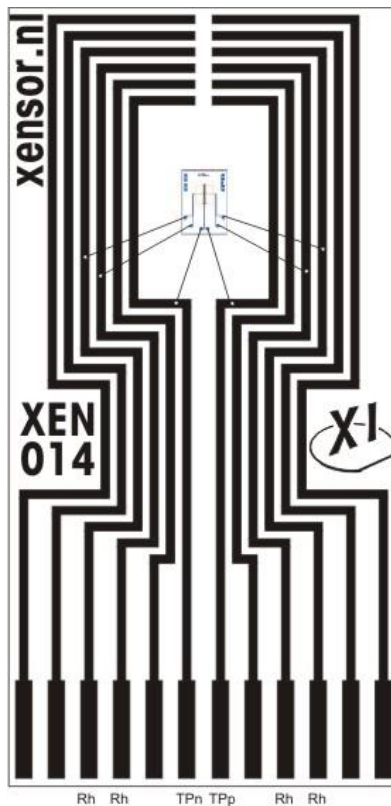
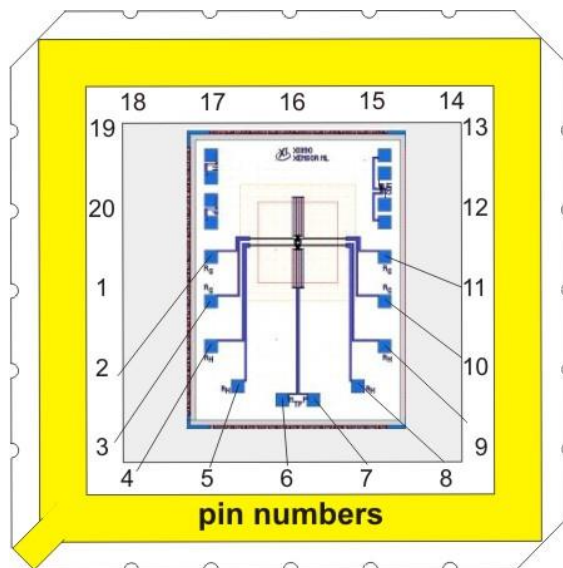

Figure 5.9 XEN-39395 on XEN-40014.

pin (left to right)

- 1 nc
- 2 nc
- 3 R_{heat} (-)
- 4 R_{heat} (-)
- 5 nc
- 6 Out (-)
- 7 Out (+)
- 8 nc
- 9 R_{heat} (+)
- 10 R_{heat} (+)
- 11 nc
- 12 nc

Designs: XI-393 t/m XI-395.



pin	
1	nc
2	R _{guard} (-)
3	R _{guard} (-)
4	R _{heat} (-)
5	R _{heat} (-)
6	Out (-)
7	Out (+)
8	R _{heat} (+)
9	R _{heat} (+)
10	R _{guard} (+)
11	R _{guard} (+)
12-20	nc

Figure 5.10 XEN-39390 on LCC-20nn.

Designs: XI-390 t/m XI-392 + XI-398 t/m XI-399

Conditions: Use of sensors for industrial applications is subjected to patent rights. RS Product Solutions assumes no liability arising from violation of these rights

Warranty: RS Product Solutions warrants its products against defects in materials and workmanship for 12 months from date of shipment. Products not subject to misuse will be replaced or repaired. The foregoing is in lieu of all other expressed or implied warranties. RS Product Solutions reserves the right to make changes to any product herein and assumes no liability arising out of the application or use of any product or circuit described or referenced herein.