



# Magnetic Float Type Level Switch (Horizontal Float Type)

Model : SFM/SHM



**SeoJin Instech Co., Ltd.**

[www.seojin.biz](http://www.seojin.biz)

# SFM (Reed Switch)

## Mini Magnetic Float Type Level Switch

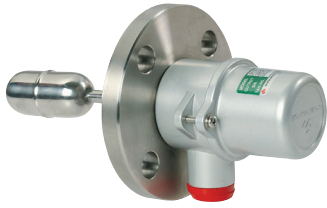

Hydraulic Equipment.  
Lubricating Oil and Coolant Tanks

### Introduction

SFM series float type liquid level switch made by Seojin Instech is intended for mounting on the sidewall of a tank.

This product is sturdy, switching action is definite, and it is easy to be installed and maintained.

### Features

- Small size
- Simple installation
- Wide adaptability
- Can be activated at the boundary of two liquids (SFM-16)

### Principle

When the float is tilted upward by the rising liquid level, the magnet attached to the end of the body actuates the reed switch.

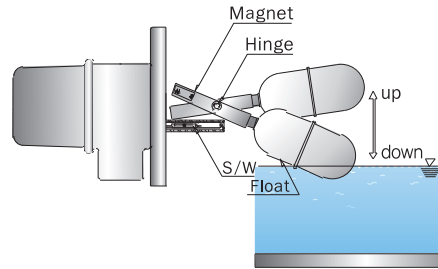

### Specifications

Type	SFM-11	SFM-12	SFM-13	SFM-14	SFM-16
Switch Rating	300V AC/350V DC, 0.5A / 50W,70VA				
Operating Temperature	10 ~ +120°C				10 ~ +80°C
Operating Pressure	5kgf/cm <sup>2</sup>		5kgf/cm <sup>2</sup>	5kgf/cm <sup>2</sup>	
Switch	Reed Switch				
Output	1SPST	1SPDT	1SPST		
S.G	0.7				
Actuation Angle	9 ~ +23°	±23°	9° ~ +23°		
Mounting Standard	JIS 5K 40A FF		PT 1½"	JIS 5K 40A FF	
Material	Sensing part	304SS / 316LSS			304SS / NBR Float
	Housing part	ADC (IP65)			

### Dimensions

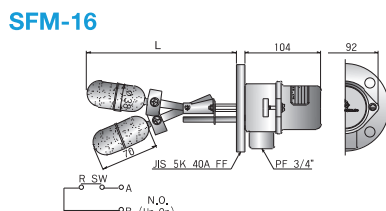
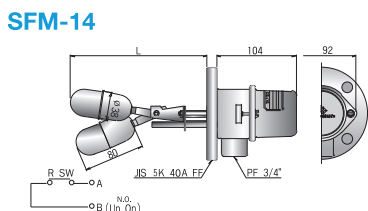
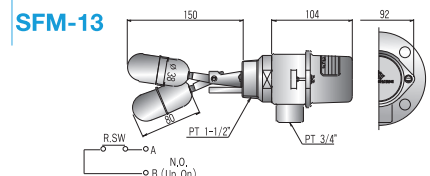
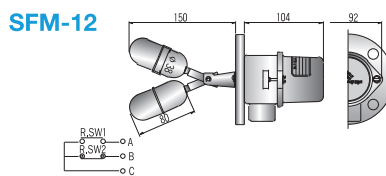
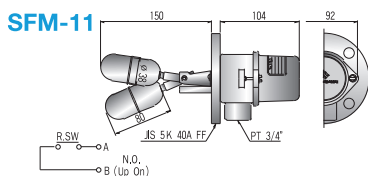

※1 ※1. SFM-16 can be activated at the boundary of two liquids

## Ordering Information

### ■ Mini Magnetic Float Type Level Switch (Reed Switch Type)

SFM - 11 A 1 A 1

#### CONDUIT CONNECTION

- 1 = PF 3/4" (Std.)
- 2 = PT 3/4"
- 3 = PF 1/2"
- 4 = PT 1/2"
- 5 = NPT1/2"
- 6 = NPT3/4"
- OP = etc.

#### MOUNTING SIZE

- A = JIS 5K 40A Flange (SFM 11, 12, 14, 16, Std.)
- B = PT 1 1/2" (SFM-13 Std.)
- C = JIS 10K 40A Flange
- OP=etc.

#### MEASURING PART LENGTH

- 1 = 150 mm : SFM - 11, 12 (Std.)
- 2 = 150 mm : SFM - 13 (Std.)
- 3 = 151~ 300 mm (Max.) : SFM - 14, 16

#### WET PART MATERIAL

- A = 304SS (Std.)
- B = 316LSS

#### FUNCTION

- 11 = 1 SPST (Std.)
- 12 = 1 SPDT (Std.)
- 13 = 1 SPST (Std.)
- 14 = 1 SPST Extension type ( Max. 300 mm)
- 16 = 1 SPST Boundary detection type ( Max. 300mm)

## Table for Chamber Selection

### Float Opening

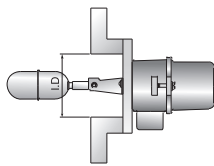

Float (Min. I.D)  
 SFM - 11, 12, 13, 16 : 41mm  
 SFM - 14 : 44mm

### Nozzle Length

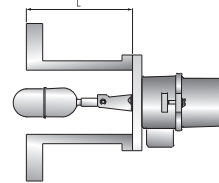

From float to tank (Max. Distance : L)  
 SFM - 11, 12, 13, 16 : 160 mm  
 SFM - 14 : 60 mm + "A"  
 "A" Value means a distance of extended part

### Pipe Opening

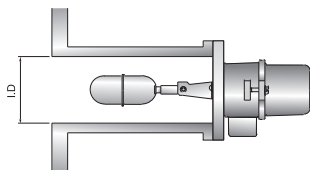

Pipe (Min. I.D)  
 SFM - 11, 13, 14 : 120mm  
 SFM - 12, 16 : 130mm

### Orientation

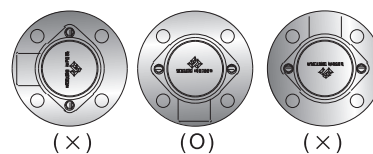

Opening for electrical conduit should face down

# SHM-100 (Micro Switch)

## Horizontal Magnetic Float Type Level Switch

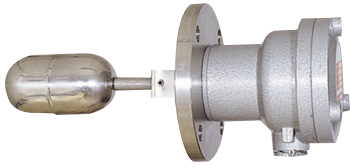

**Hydraulic Equipment.  
Lubricating Oils and Coolant Tanks.**

### Introduction

SHM series float type liquid level switch made by Seojin Instech is intended for mounting on the sidewall of a tank. This product is sturdy, switching action is definite, and it is easy to be installed and maintained.

### Principle

When the float is tilted upward by the rising liquid level, the magnet attached to the end of the body actuates the micro-switch.

### Features

- Various models to choose
- Excellent adaptability
- Selectable float chamber
- Simple installation
- Explosion proof available (Ex d IIC T6, IP65)

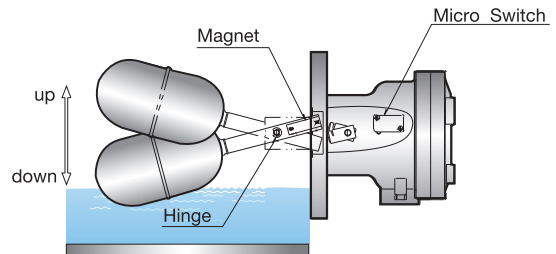

### Specifications

Type		SHM - 100	SHM - 100E	SHM - 100T
Switch Rating			250V AC, 10A	
Switch			Micro Switch	
Process Temperature	Sensing Part	-25 ~ +120°C	-20 ~ 60°C	-25 ~ +230°C
	Housing Part	-25 ~ +120°C	-20 ~ 60°C	-25 ~ +120°C
Operating Pressure		10kgf/cm <sup>2</sup> (Max.)		
Output		1SPDT		
Specific Gravity		0.7(Min.)		
Actuation Angle		±15°		
Mounting Standard		JIS 5K 65A FF		
Material	Sensing Part	304SS / 316LSS		
	Housing Part	ADC	Cast Aluminum	
Enclosure Class		Weather proof	Explosion proof (Ex d IIC T6 / IP65)	Weather proof

### Dimensions

SHM-100 (Std.)

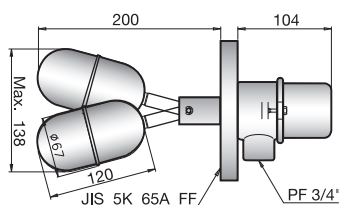

SHM-100E (Std.)

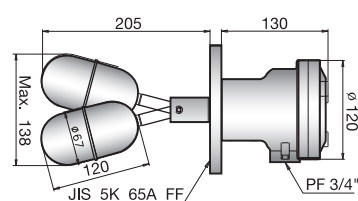

## Table for Chamber Selection

A	B	C	D

## Ordering Information

### Horizontal Mini Magnet Type Float Level Switch

SHM-100 A 1 A 1 A 1

#### CONDUIT CONNECTION

- 1 = PF 3/4" (Std.)
- 2 = PT 3/4"
- 3 = PF 1/2"
- 4 = PT 1/2"
- 5 = NPT1/2"
- 6 = NPT3/4"
- OP=etc.

#### ENCLOSURE

- A = Weather proof (Std.)
- B = Explosion proof (Ex d IIC T6 / IP65)

#### MEASURING PART LENGTH

- 1 = 200 mm (Std.)
- 2 = 201 ~ 300 mm
- 3 = 301 ~ 400 mm (Max.)

#### MOUNTING SIZE

- A = JIS 5K 65A Flange (Std.)
- B = JIS 10K 65A Flange
- OP = etc.

#### PROCESS TEMPERATURE

- 1 = -20 ~ + 120°C (Std.)
- 2 = -20 ~ + 230°C

#### WET PART MATERIAL

- A = 304SS (Std.)
- B = 316LSS

### Chamber

SHM -100CH A 1 # # # #

#### CHAMBER SCH# (Pressure Rate)

#### CHAMBER PARTS MATERIAL

- 1 = Carbon Steel (A105)
- 2 = 304SS
- 3 = 316LSS
- OP = etc.

#### TYPE OF CHAMBER

- A = Top Bottom (Socket Weld type)
- B = Side Bottom (Socket Weld type)
- C = Side Side (1) (Flange type)
- D = Side Side (2) (Flange type)
- OP = etc.

When placing an order, selected ordering number should be indicated on the purchase order sheet.

## Precaution

- Avoid dropping or shocking the Level Switches (Fig. 1)
- Do not install the switches near a drain outlet or a feed-water inlet to avoid malfunction due to chattering (Fig. 2)
- Installation near a strong magnetic field should be avoided to prevent malfunction (Fig. 3)
- This type of Level Switch should not be used for liquids containing iron particles or other strongly magnetic material. The Switches must be cleaned frequently if the liquid has high viscosity or contains floating material (Fig. 4)

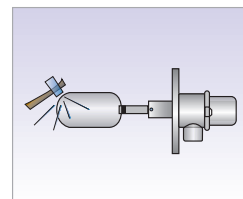

(fig. 1)

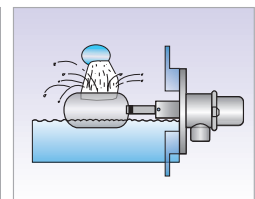

(fig. 2)

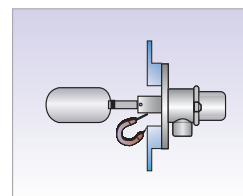

(fig. 3)

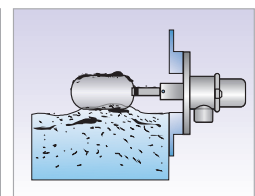

(fig. 4)

# SHM-2000

## Vertical Magnetic Float Type Level Switch



### Features

- Liquid level control for high temperature and/or high pressure systems.(350°C 100 bar)
- For control of levels in turbine service tanks of electric power plants.
- For control of boiler feed-water and other pressure vessels.
- For control of levels in oil tanks and petrochemical processing plants.
- A variety of mounting chambers are available.
- Simple installation.
- Selectable of installation chambers.

### Introduction

The float and body of this model rotates around a single point to induce a vertical linear displacement to a mechanism to actuate a heatproof micro-switch.

### Principle

The range of linear core movement is determined by selecting the rotating angle of the float and lengths, L1 and L2, to actuate the micro-switch, which controls the power to pump or drain equipment.

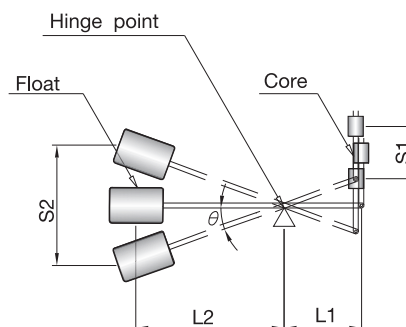

### Specifications

SHM-2000 Type		Std.	Explosion Proof
Contact Capacity		125V AC, 15A / 250V AC, 5A	
Switch		Heat-proof Micro Switch	
Process Temperature	Sensing Part	-25 ~ +350°C (Max.)	
	Housing Part	-25 ~ 120°C	-20 ~ 60°C
Operating Pressure		10kgf/cm <sup>2</sup> (Max.)	
Output		1SPDT, 1DPDT	
Specific Gravity		0.6(Min.)	
Actuation Angle		±6°	
Mounting Standard		JIS 10K 80A FF (Std.), Option for other	
Material	Sensing Part	304SS / 316LSS	
	Body Part	304SS / 316SS / Carbon Steel	
	Housing Part	ADC, Cast Aluminum	
Enclosure Class		Weather proof	Explosion proof (Ex d IIC T6, IP65)

## Dimensions

**A1A1A1**

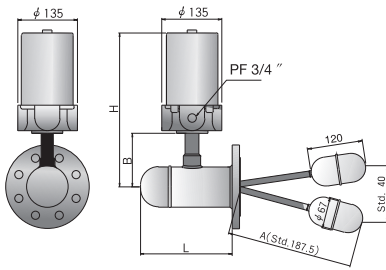

**A3A1A1**

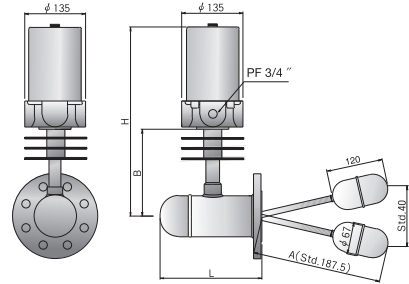

**A1A1B1**

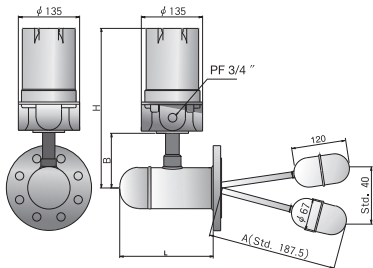

**A3A1B1**

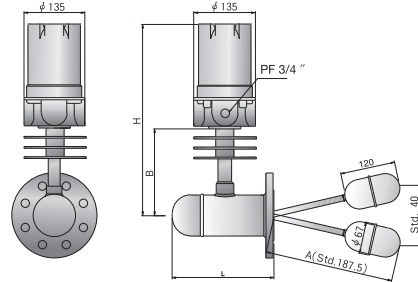

## Table for Chamber Selection

A	B	C	D

## Installation Requirement

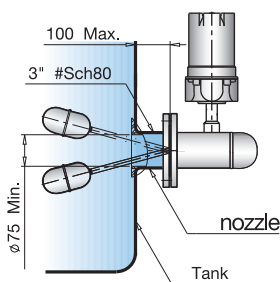

When using a nozzle

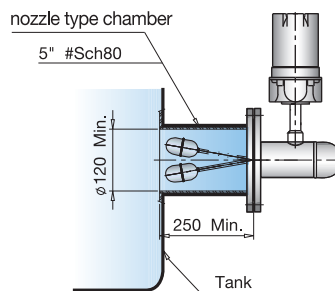

When using a chamber

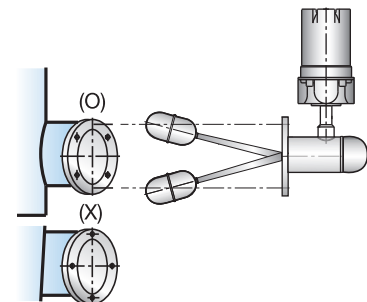

The centerline of bolt holes should line up with the vertical centerline of the flange.

## Ordering Information

### Vertical Magnetic Float Type Level Switch

SHM-2000 A 1 A 1 A 1

#### CONDUIT CONNECTION

- 1 = PF 3/4" (Std.)
- 2 = PT 3/4"
- 3 = PF 1/2"
- 4 = PT 1/2"
- 5 = NPT1/2"
- 6 = NPT3/4"
- OP=etc

#### ENCLOSURE

- A = Weather proof (C.S Cover Std.)
- B = Explosion proof (Ex d IIC T6 / IP65)

#### OUTPUT

- 1 = 1 SPDT
- 2 = 1 DPDT

#### MOUNTING SIZE

- A = JIS 10K 80A FF Flange(Std.)
- B = JIS 10K 100A FF Flange
- C = ANSI 3" 150lb RF Flange
- D = ANSI 4" 150lb RF Flange
- E = JIS & ANSI 5" (Chamber type only)
- OP = etc.

#### PROCESS TEMPERATURE

- 1 = -25 ~ +150°C
- 2 = -25 ~ +230°C
- 3 = -25 ~ +350°C

#### WET PART MATERIAL

- A = 304SS
- B = 316LSS
- C = Carbon Steel
- OP = etc.

### CHAMBER

SHM-2000CH A 1 ###

CHAMBER SCH# (STD. 5"/125A)  
(Pressure Rate)

#### CHAMBER PARTS MATERIAL

- 1 = Carbon Steel
- 2 = 304SS
- 3 = 316LSS
- OP = etc.

#### TYPE OF CHAMBER

- A = Top Bottom (Socket weld type)
- B = Side Bottom (Socket weld type)
- C = Side Side(1) (Flange type)
- D = Side Side(2) (Flange type)
- OP = etc.

■ When placing an order, selected ordering number should be indicated on the purchase order sheet.

 **SeoJin Instech Co., Ltd.**

14, Dunchon-daero 457beon-gil, Junwon-gu  
Seongnam-si, Gyeonggi-do, Korea[Zip.13218]

☎ +82-31-627-9000 📠 +82-31-624-5345

<http://www.seojin.biz>

2018 Edition Rev.0 (printed by Daoom)

■ Specifications subject to change without notice