

Remote Drum Level Indicator (RDLI) & Switch (RDLS) Series

Model : SDG-3000/SDS-3000

SDG-3000/SDS-3000

Remote Drum Level Indicator & Switch (RDLI / RDLS Series)



Introduction

Steam/water interfaces in the various high pressure and high temperature steam drums operated in electricity-generating power plants, glass, cement, petrochemical, steel, and paper making plants require close monitoring and controlling for safe, efficient and reliable operation. Since most of these steam drums normally operate at very high pressure and temperatures, any malfunction of the level measuring and controlling instruments must be prevented so that serious interruptions and costly damages to the process or equipment can be precluded.

In spite of the importance of close monitoring and controlling of the drum levels, industries in the past have relied on such devices as glass and float-type level switches. But they often malfunctioned, and required service or replacement interrupting the normal operation and processes. Based on many years of experience as the leading supplier of level and flow sensing instruments and in-company technological innovation, SEOJIN INSTECH has succeeded in developing this electrode-type steam drum interface monitoring system that operates reliably in the extremely high pressure and temperature environment of up to 300bar and 560°C.

Capabilities

- Measures the steam/water interface level
- No moving part
- Maximum operating temperature : 560°C
- Maximum operating pressure : 300Bar (4350psi)
- On-site and remote indication and alarm
- Indication and alarm for accumulation of extraneous matters
- Individual indication of damaged (leaky) electrodes
- Indication of disconnected wire
- Output signals compatible with power plant requirements
- CPU-based control functions
- Availability of optional modules to accommodate particular needs :
 - PCB design in time of a power failure
 - Number of control signals can be increased to 5 relays per board
 - Number of electrodes can be chosen 8, 12 and 16 for continuous level
- Choice of High-Pressure or Low-Pressure electrodes depending on local needs
- Availability of High-Pressure or Low-Pressure water columns
- Simple installation and set-up, and easy maintenance
- Six thousands of similar electrodes are already in use worldwide.

System Components

- Electrodes : selectable between 8, 12 and 16
 - High temperature/pressure (SHE-56) : 560°C/300Bar
 - Low temperature/pressure (SLE-26) : 260°C/50Bar
- Local display and alarm control units (SDG-3000 for continuous systems and SDS-3000 for switching system)
- Remote display units (SRD-32 / Installation in the CCR / Panel mount type)
- Water columns
 - For high temperature/pressure up to 560°C/300Bar : HPC-3056
 - For low temperature/pressure up to 260°C/ 50 Bar : LPC-2137
- Connecting cables for high temperature applications

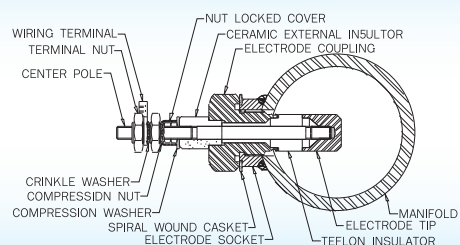

* Modern boilers provide clean dry steam.

Incorrect water level in the drum must be detected :

Too high level can lead to turbine blade erosion by wet steam, and too low level can cause explosion due to the boiler tube overheating. Therefore, indication of water level in steam generating plant and drum level indication in the control room are required law by in every country.

Operating Principle

Two columns of off-set electrodes are installed along the opposing sides of a water column, which is usually installed to the boiler such that one half of the electrodes are above the normal water level.

The water column is connected between steam and water pipes which are attached to the boiler. If desired, the water column may be isolated from the boiler by valves so that installation of electrodes or maintenance work can be performed without shutting down the operation.

Electrodes from each side of the two columns are connected to one electronics unit by separate cables. Two conductors are connected to each electrode, one for signal drive and the other for return signal. A low-frequency square wave is used to drive the electrodes through drive resistors. Input board, each powered by its own power supply measure the signal from each electrode and feed alternate segments of the display.

This arrangement assures redundancy against failure in any part of the system. Depending on 5 relay installed can be used to operate trips, audible, visual or other alarm indications.

Each relay can be set to operate at any water level. For example, alarm could be set to give outputs on high-high, high, low and low-low levels, with trips on the high-high and low-low levels.

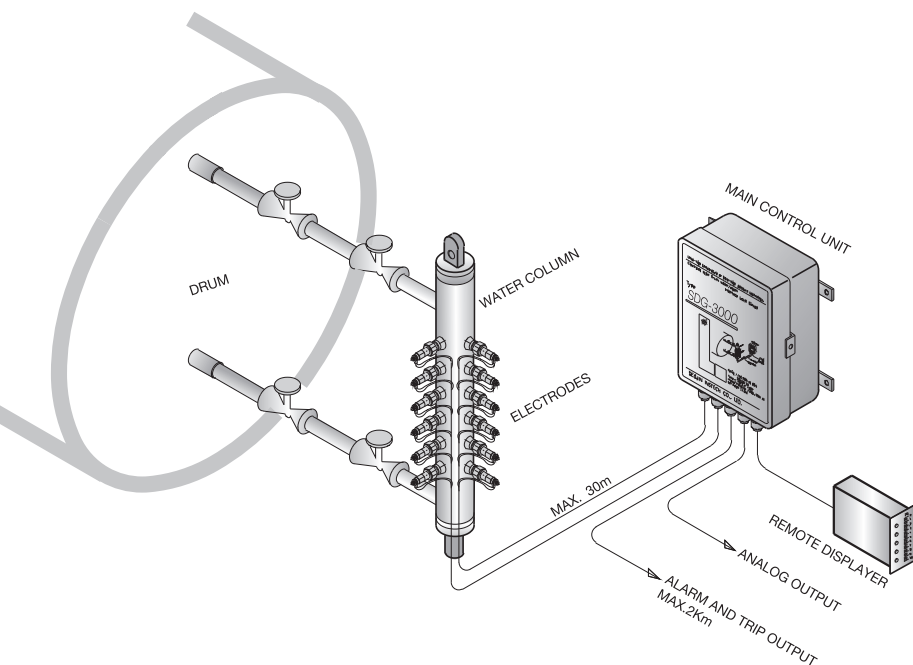

The electronics unit performs a resistance measurement between the insulated tip of each electrode and the wall of the water column. The resistance measured in water is significantly less than that measured in steam. The presence or absence of water is determined at each point, and the level of water is indicated.

If no signal is returned, or a very low amplitude signal is returned, it is an indication of either a short circuit or a broken wire. Thus, faulty conditions are also indicated on the display.

The levels indicated in the control room can also be duplicated on remote display units. All other functions, including fault indications, of the main display unit are duplicated on up to six remote display units.

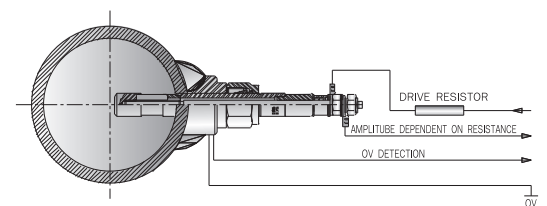

Water columns are designed and fabricated to the same level of reliability as that has been built into the electrodes and the rest of the system.

For example, the columns are designed to withstand 150% of the rated high pressure of 300 bar, and their hydraulic integrity are tested through approved NDT methods and Hydrostatic tests. In addition, all materials and fittings used are selected to comply with ASME Boiler and Pressure Vessel and ASME B31.1 Power Piping Codes. CMTR/WPS/PQR documentation will be provided to the customer if requested.

SEOJIN INSTECH is a member of ASME, Korea Electric Power Institute Code (KEPIC), and is a registered organization for fabrication of Q-Class equipment for nuclear and fossil electric power plants, and is also recognized as an Outstanding Venture Company by Korea Electric Power Company (KEPCO).

Electrode Status	Received (at 300 °C) (Resistance - KΩ / Dielectric - μS / cm)	
Steam		High Resistance
Water		Low Resistance
Fault		Very Low Resistance

SDG - 3000

Remote Drum Level Indicator (RDLI)

Outstanding Features

- Can issue and display alarms for a broken wire, leaky electrode or material build-up on electrodes.
- Uses Micro processor based CPU.
- Output signals are compatible with the various controller such as PLC's
- Relay output : Dry contact relay for control, alarm lamps and local buzzers. (5 SPDT)
- Dual alarm and display system : 2 rows × 16 LED(10×10mm Red/Green bar graph)
0 ~ 100% indicating FND Digital meter.

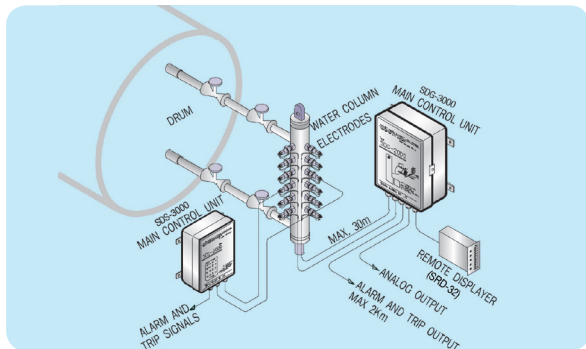

For ultimate protection SDG-3000 and SDS-3000 can be combined in a single water column.



System Specifications

▶ Control Unit (MODEL: SDG-3000)

- Power : 100 ~ 240VAC free voltage. 50/60Hz. Max. 20W
*Switching Mode Power Supply(SMPS) on the main board.
- Ambient Temperature : -20°C ~ 70°C (-4°F ~ 158°F)
- Water/steam interface conductivity :
0.6~1.6μS/cm depending on purity.
- Number of electrodes : 8, 10 and 16 pieces.
- Electrode cable length : 10, 20, and 30m.
- Local displays :
* Level indication : 10 × 10mm. 2 rows × 16 Red/Green LED Bar graph, and 20mm(H) × 3 Digit FND digital meter for % indication.
* Status : Steam = Red LED ON
Water = Green LED ON
Leaky electrode, Separated wire, Impure material = Alternate red & green LED blinking
Abnormal operation = Fault LED ON
- Output
Analog output : 4 ~ 20mA / 0 ~ 20mA. 600Ω
or 20 ~ 4mA / 20 ~ 0mA (Isolation loop power supply type)
Relay output : 5 SPDT relays on main board.
Contact rating : 250V.5A.1500VA
- Enclosure : Mild steel with Epoxy coated Case. 4 point wall mount. (Optional : Stainless steel 304ss, 316ss with Epoxy coated)
Size : 386(H) × 270(W) × 105(D)mm
Protection Grade : IP65. Weather & dust proof.
Net weight : 5.6kg(13.67lb)

▶ Remote Display Unit (MODEL: SRD-32)

- Power Supply : Loop power is supplied by Control unit SDG-3000
Local power : 20 ~ 36VDC. 240mA.
- Extension units : Max. of 6 if power is locally supplied.
(1 if power is use control unit loop power)
- Remote display : 5 × 10mm. 16 × 2rows (Red/Green LED Bar graph) & 12mm(H) × 3 Digit FND digital meter for % indication.
- Remote indication : Fault display for impurity, broken wire, & leaky electrode
- Enclosure : Panel mount type 144(H) × 72(W) × 167(D)mm
Panel cutout : 137(H) × 67(W)mm

▶ Water Columns(Chamber) - With Protection Cover

Applicable Design and Material Codes :
ASME 31.1 Power Piping Code

■ For high temperature / pressure applications (MODEL : HPC-3056)

- Material : 2" Sch.160 A106B/316SS
- Application pressure limit : 300 Bar(303kg/cm²/4350psi)
- Design pressure : 450 Bar(459kg/cm²/6525psi)
- Temperature : 560°C(1040°F)
- Electrode : SHE-56

■ For Low temperature / pressure applications (MODEL : LPC-2137)

- Material : 2" Sch.80 A106B/316SS
- Application pressure limit : 50 Bar(51kg/cm²/725psi)
- Design pressure : 100 Bar(102kg/cm²/1450psi)
- Temperature : 260°C(500°F)
- Electrode : SLE-26



Electrode for high temperature and pressure SHE-56



Electrode for low temperature and pressure SLE-26

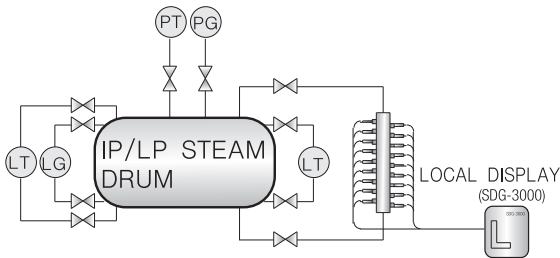
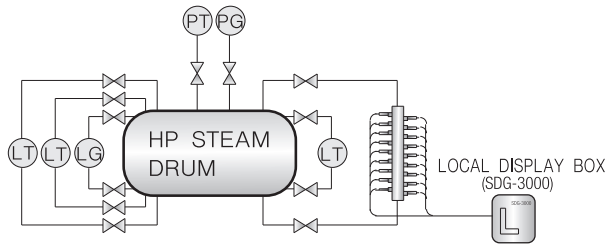

Reduction of Density Error

(Preparation for installation of a water column)

The water column and the connecting pipes generally are well insulated, but the insulation is not sufficient to keep the water in the water column as hot as that inside the drum. Density of the cooler water in the water column is denser than that in the drum, and therefore the water level in the water column is lower than that inside the drum. This phenomenon, known as the Density Error, could induce as much as 150mm of measurement error in some cases.

However, the error can be limited to about 20mm by deliberately exposing a part of the hot leg pipe close to the water column as illustrated in the figure.

The steam inside the exposed portion of the pipe cools and condenses, releasing the latent heat of condensation to the water. This results in raising the temperature of water in the water column appreciably higher compared to the water without the exposed section, thereby reducing the density error.

For this method to be effective the connecting pipes must be installed with proper inclinations and insulated as shown in the figure. In cases where the height of the water column exceeds 1m, water column itself may have to be thermally insulated.

Electrodes

(SDG-3000 for Level Indicating and SDS-3000 for Switching)

Model SLE-26 for Low Temperature and Pressure Applications

- Pressure : 50 bar(51kg/cm²/725psi)
- Temperature : 260°C(500°F)
- Insulator material : PTFE
- Electrode material : 316SS and special alloy
- Fittings : Screw mount. M18×1.5 / Metal gasket.
- Design and test pressure : 100 Bar(102kg/cm², 1450psi)
- Water column used : LPC-2137

Model SHE-56 for High Temperature and Pressure Applications

- Pressure : 300 Bar(306kg/cm², 4350psi)
- Temperature : 560°C(1040°F)
- Insulator material : High purity alumina ceramic
- Electrode material : 316SS and special alloy(Kovar)
- Fittings : 22mm A/F nut. 3/4"x20 UNEF Ferrule type mechanical seal
- Design and test pressure : 450 Bar(459kg/cm², 6525psi)
- Water column used : HPC-3056

Application Examples

(A Fossil power plant & a Combined-Cycle power plant)

Steam/water interface gauging system for high pressure drum

- Level Transmitter - 3sets
- Level Gauge - 1 set
- Level Switch - 2 sets
- RDLI(SDG-3000) - 1 set

Steam/water interface gauging system for intermediate and low pressure drum

- Level Transmitter - 2sets
- Level Gauge - 1 set
- RDLI(SDG-3000) - 1 set

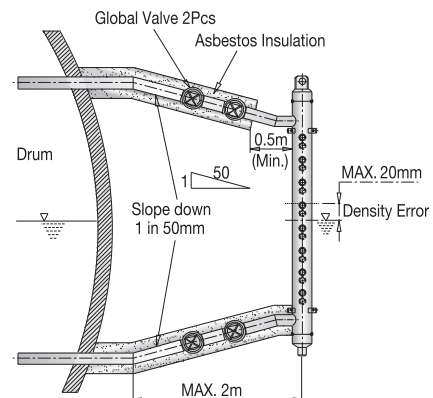

Ordering Information

Remote Drum Level Indicator (RDLI)

SDG-3000

A

1

A

1

A

0

A

1

DRAIN VALVE

1 = None
2 = Yes (Separate order / Valve spec.)

STANCHION & SUNSHADE

A = None
B = Stanchion only (In-door type)
C = Sunshade type Stanchion

REMOTE DISPLAY UNIT (SRD-64N)

0 = None
1 = 1 Set (General)
2~6 = 2 ~ 6 Set

ELECTRODES SPECIAL CABLE

A = 10m (Std)
B = 20m
C = 30m Max.

WATER COLUMN TYPE

1 = HPC-3056 A106B
2 = HPC-3056 316ss
3 = LPC-2137 A106B
4 = LPC-2137 316ss
(With electrodes protection cover / 316ss)

ELECTRODES QUANTITY

A = 8 pieces
B = 12 pieces
C = 16 pieces (General)

ELECTRODES TYPE

1 = SHE-56 : High temp. & High pressure type
2 = SLE-26 : Low temp. & Low pressure type

LOCAL PANEL TYPE

A = Mild steel with Epoxy coated enclosure
B = 304ss with Epoxy coated enclosure
C = 316ss with Epoxy coated enclosure

■ When placing an order, selected ordering number should be indicated on the purchase order sheet.

SDS - 3000

Remote Drum Level Switch (RDLS)

Outstanding Features

- Can issue and display alarms for a broken wire, leaky electrode or material build-up on electrodes.
- Uses Micro processor based CPU
- Output signals are compatible with the various controllers such as PLC's :
 - Switching Mode Power Supply(SMPS) on the main board.
 - Relay output : Dry contact relay(3 DPDT)
- Various combination of electrodes :
 - 1 Electrode (1 DPDT On/Off type)
 - 2 Electrodes(2 DPDT H/L On/Off type)

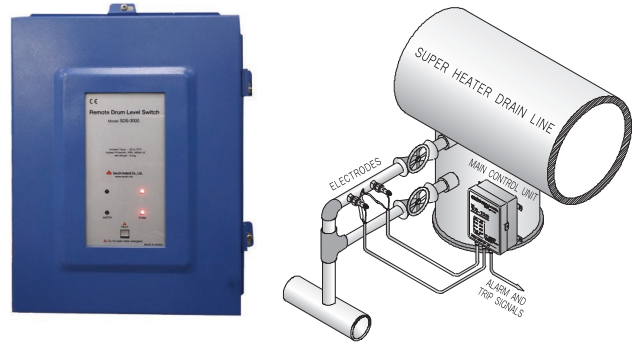

■ When used as Steam Normal - High level alarm

- Prevention of turbine moisture absorption
- Steam drain line adjustment
- Protection of boiler high water level
- Motor coil cooler
- Continously can monitor Power problem.
Power loss or the failure of a power supply are indicated by the LED and cause the fault relays to be de-energized.

System Specifications

► Control Unit (MODEL: SDS-3000)

- Power : 100 ~ 240VAC Free voltage. 50/60Hz. 10VA Max. 15W
Switching Mode Power Supply(SMPS) on the main board.
- Ambient Temperature and humidity :
-20°C ~ 70°C (-4°F ~ 158°F) / 100%RH
- Water/steam interface conductivity : 0.6 ~ 1.6μS/cm
depending on purity
- Number of electrode : 1 ~ 2 pieces
- Electrode cable length : 10m(Std), 20m, 30m Max.
- Local displays :
Level indication
Steam status = Red LED
Water status = Green LED
Abnormal operation = Fault LED
(Power Fault)

- Output : Relay output :
Steam/Water Status relay : 2C DPDT
Abnormal alarm fault relay : 1C DPDT
Maximum contact voltage : 250VAC, 30VDC
Maximum contact current : 5A
- Enclosure :
Mild steel with Epoxy coated case. 4 point wall mount.
Size : 388(H)×270(W)×105(D)mm
Protection Grade : IP65. Weather & dust proof.
Net weight : 5.6Kg

Remote Drum Level Switch (RDLS)

Application Examples

(Fossil Power and Combined-Cycle Power Plants)

► 1 Superheater, 2 Drain Line (Steam / Water Detection)

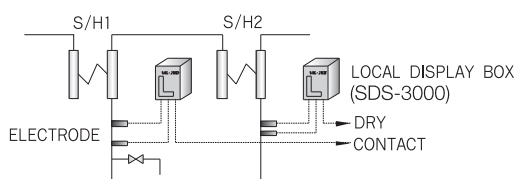

► 1 Reheater , 2 Drain Line (Steam / Water Detection)

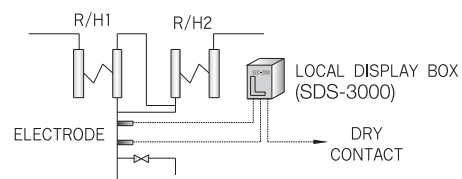

► **High Pressure chamber**
(MODEL : SM-3056)

- With Electrodes Protection Cover
- Style : Side Arm(Vertical) and In Line(Horizontal)
- Material : 2" Sch.160 A106B / 316ss
- Pressure : 300 bar(303Kg/cm²/4350psi)
- Temperature : 560°C(1040°F)
- Electrode : SHE-56

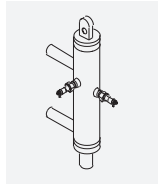

► **Low Pressure chamber**
(MODEL : SLC-1234)

- With Electrodes Protection Cover
- Style : Side Arm(Vertical) and in Line(Horizontal)
- Material : 2" Sch.80 A106B / 316ss
- Design pressure : 50 Bar (725psi)
- Temperature : 260°C(500°F)
- Electrode : SLE-26

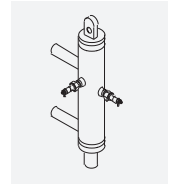

Ordering Information

■ **Remote Drum Level Switch (RDLS)**

SDS-3000 A 1 1 H 1 A 1 A

LOCAL PANEL TYPE

- A = Mild steel with Epoxy coated enclosure
- B = 304ss with Epoxy coated enclosure
- C = 316ss with Epoxy coated enclosure

ELECTRODES TYPE

- 1 = SHE-56 : High Temp. & High Pressure type
- 2 = SLE-26 : Low Temp. & Low Pressure type

ELECTRODES QUANTITY

1 ~ 2 PCS

ELECTRODES CHAMBER TYPE

- H = Chamber Type SM-3056
- L = Chamber Type SM-1234

CHAMBER MATERIAL

- 1 = A106 Carbon Steel
- 2 = A335 P11
- 3 = A335 P12
- 4 = A335 P22
- 5 = A335 P91
- 6 = A312 TP304
- 7 = A312 TP316

ELECTRODE SPECIAL CABLE

- A = 10m(Std)
- B = 20m
- C = 30m(Max.)

STANCHION & SUNSHADE

- 1 = None
- 2 = Stanchion only(In-door type)
- 3 = Sunshade type Stanchion

DRAIN VALVE

- A = None
- B = Yes(Separate order / Valve spec.)

■ When placing an order, selected ordering number should be indicated on the purchase order sheet.



14, Dunchon-daero 457beon-gil, Junwon-gu Seongnam-si, Gyeonggi-do, Korea[Zip.13218]

+82-31-627-9000 +82-31-624-5345

http://www.seojin.biz

2018 Edition Rev.0 (printed by Daoom)

■ Specifications subject to change without notice