

UMG 511

Class A power quality analyser



Communication

- Profibus (DP/V0)
- Modbus (RTU, TCP, Gateway)
- TCP/IP
- BACnet (optional)
- HTTP (configurable homepage)
- FTP (file transfer)
- TFTP
- NTP (time synchronisation)
- SMTP (email function)
- DHCP
- SNMP

Interfaces

- Ethernet
- Profibus / RS485 (DSUB-9)

Accuracy of measurement

- Energy: Class 0.2S (... / 5 A)
- Current: 0.2 %
- Voltage: 0.1 %

Power quality acc. Class A

- Harmonics up to the 63rd harmonic
- Flicker measurement
- Short-term interruptions (> 20 ms)
- Transient recorder (> 50 µs)
- Starting currents (> 10 ms)
- Unbalance
- Half wave RMS recordings (up to 4.5 min.)

Networks

- IT, TN, TT networks
- 3 and 4-phase networks

Measured data memory

- 256 MByte Flash

Programming language

- Graphical programming
- Jasic®
- PLC functionality

8 digital inputs

- Pulse input
- Logic input
- State monitoring
- HT / LT switching

5 digital outputs

- Pulse output kWh / kvarh
- Switch output
- Threshold value output
- Logic output

(expandable via external I/O modules)

Peak demand management (optional)

- Up to 64 switch-off stages

Network visualisation software

- Free GridVis®-Basic
- PQ Report Generator

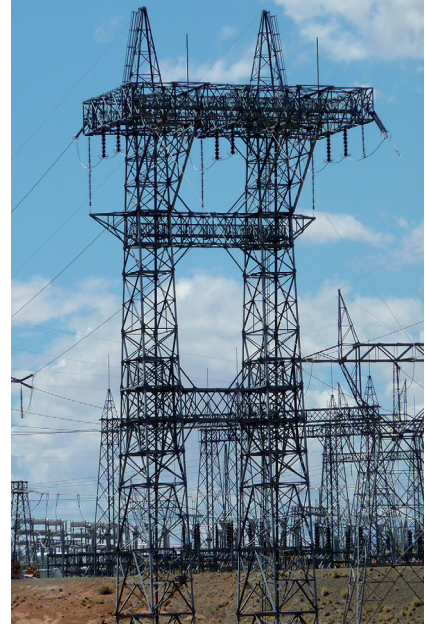

Areas of application



- Continuous monitoring of the power quality
- Harmonics analysis with power quality problems
- Checking the internal supply network according to EN 61000-4-7, EN 6100-4-15, EN 61000-4-30
- Fault analysis in case of problems with the energy supply
- Documentation of the power quality for customers and regulatory authorities
- Ethernet Gateway for subordinate measurement points
- Report generator for power quality standards: EN 50160, IEE519, ITIC ...
- Report generator for energy consumptions
- Energy Dashboard
- Remote monitoring of critical processes

Main features



Power quality

- Harmonics analysis up to the 63rd harmonic, even / odd (U, I, P, Q)
- Interharmonics (U, I)
- Distortion factor THD-U / THD-I / TDD
- Measurement of positive, negative and zero sequence component
- Unbalance
- Direction of rotation field
- Voltage crest factor
- Flicker measurement in accordance with DIN EN 61000-4-15
- Logging and storage of transients (> 50 μ s)
- Short-term interruptions (> 20 ms)
- Monitoring start-up processes

High quality measurement

- Constant true RMS measurement
- Measurement process in accordance with IEC 61000-4-30
- Certified accuracy of measurement according to class A
- Continuous sampling of the voltage and current measurement inputs at 20,000 Hz
- 400 measurement points per period
- Recording of over 2,000 measured values per measurement cycle
- Accuracy of active energy measurement: Class 0.2S
- Fast measurement even enables the logging of rapid transients from 50 μ s
- Logging of currents and voltages (15 – 440 Hz)

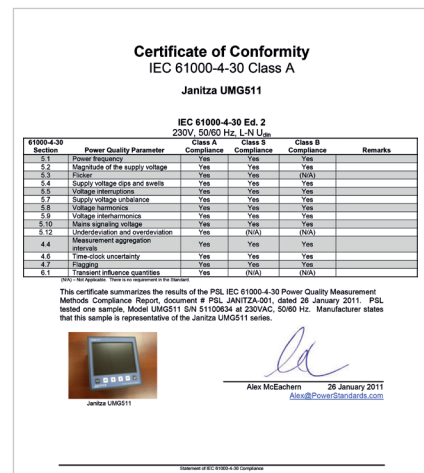

Fig.: UMG 511 Class A-certified



User-friendly, colour graphical display with intuitive user guidance

- High resolution colour graphical display 320 x 240, 256 colours, 6 buttons
- User-friendly, self-explanatory and intuitive operation
- Backlight for optimum reading, even in darker environments
- Illustration of measured values in numeric form, as a bar graph or line graph
- Clear and informative representation of online graphs and power quality events
- Multilingual: German, English, Russian, Spanish, Chinese, French, Japanese, Turkish ...

Various characteristics

- 4 voltage and 4 current measurement inputs, i.e. logging of N and / or PE possible
- 8 digital inputs, e.g. as data logger for S0 meter
- 5 digital outputs for alarm message or e.g. for connection to a BMS or PLC
- Free name assignment for the digital IOs, e.g. if used as data logger

Comprehensive communication and connection possibilities

- Modbus
- Profibus
- Ethernet (TCP/IP)
- Digital IOs
- BACnet (optional)
- Configurable Firewall



Modern communications architecture via Ethernet

- Simple integration in an Ethernet network
- Reliable and cost-optimised establishment of communication
- Ideal for Master-Slave structures
- High flexibility due to the use of open standards
- Integration in PLC systems and BMS through additional interfaces
- Various IP protocols: SNMP, ICMP (Ping), NTP, FTP ...

Transients (1..8)		
Phase	Reason	Date/Time
L1	delta	2011 Mar 16 15:33:07,122
L4	delta	2011 Mar 16 15:32:29,826
L3	delta	2011 Mar 16 15:32:29,819
L2	delta	2011 Mar 16 15:32:29,813
L2	delta	2011 Mar 16 15:32:29,806
L1	delta	2011 Mar 16 15:32:29,799
L4	delta	2011 Mar 16 15:32:29,793
L3	delta	2011 Mar 16 15:32:29,786

Fig.: Transients list

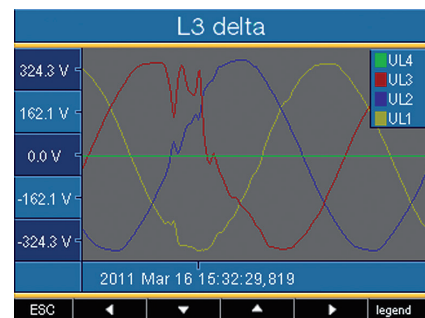

Fig.: Graphical representation of a transient



Measuring device homepage

- Web server on the measuring device, i.e. device's inbuilt homepage
- Function expansion possible through APPs
- Remote operation of the device display via the homepage
- Comprehensive measurement data incl. PQ (transients, events...)
- Online data directly available via the homepage, historic data optional via the APP measured value monitor, 51.00.245

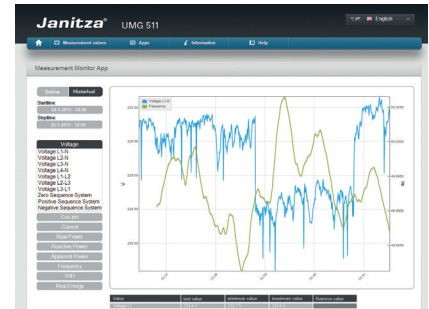

Fig.: Illustration of the historic data via the homepage



BACnet protocol for building communication

- Optimal interoperability between devices from various manufacturers
- Predefined BIBBs (BACnet Interoperability Building Block)
- BACnet is optionally available with UMG 511
- UMG 511 supports the device type B-SA with the BIBBs DS-RP-B and DS-WP-B
- Furthermore, the BIBBs DS-COV-B and DM-UTC-B are also supported

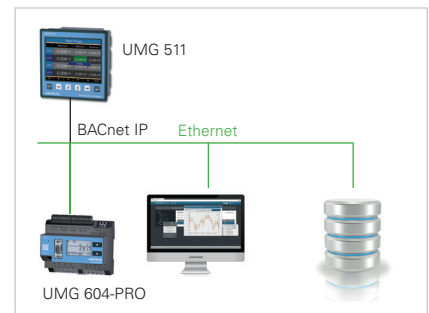

Fig.: BACnet topology



Modbus Gateway function

- Economical connection of subordinate measuring devices without Ethernet interface
- Integration of devices with Modbus-RTU interface possible (harmonisation of data format and function code necessary)
- Data can be scaled and described
- Minimised number of IP addresses required
- Tried and tested integrated solution without additional hardware



Programming / PLC functionality

- Further processing of the measurement data in the measuring device (local intelligence)
- Monitoring and alarm functions simple to program
- Sustainable functional expansions far beyond pure measurement
- Comprehensive programming options with
 - Jasic® source code programming
 - Graphical programming
- Complete APPs from the Janitza library



Large measurement data memory

- 256 MB data memory
- Memory range up to 2 years (configuration-dependent)
- Individually configurable recordings

- Recording averaging times can be freely selected
- PQ recordings template preconfigured for conventional standards (e.g. EN 50160)
- User-defined memory segmenting possible

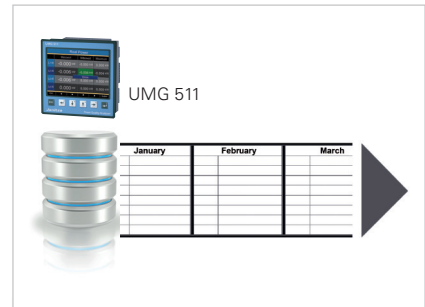

Fig.: Large measurement data memory



Powerful alarm management

- Information available immediately by email
- Inform maintenance personnel via the powerful device homepage
- Via digital outputs, Modbus addresses, GridVis® software
- Programming via Jasic® or graphical programming
- Further alarm management functions via GridVis®-Service alarm management

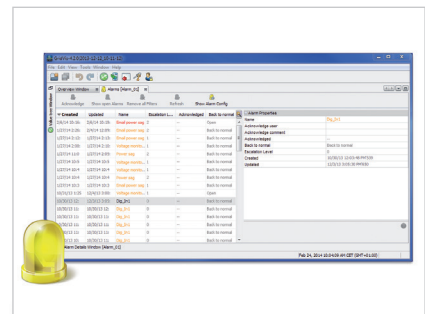

Fig.: GridVis® alarm management, alarm list (logbook)



Peak load representation and peak load management

- Illustration of the 3 highest monthly power peaks on the LCD display (P, Q, S)
- Rolling bar chart representation of the peak power values over 3 years on the LCD display (P, Q, S)
- Plain text representation on the LCD display (P)



Fig.: GridVis® load profile, asic instrument for EnMS



GridVis®-Basic power quality analysis software

- Multilingual
- Manual read-out of the measuring devices
- Manual report generation (power quality and energy consumption reports)
- Comprehensive PQ analysis with individual graphs
 - Online graphs
 - Historic graphs
 - Graph sets
- Integrated databases (Janitza DB, Derby DB)
- Graphical programming
- Topology views
- High memory range

Certified quality through independent institutes

- ISO 9001
- Energy management certified according to ISO 50001
- Class A certificate (IEC 61000-4-30)
- UL certificate
- EMC-tested product



Dimension diagrams

All dimensions in mm

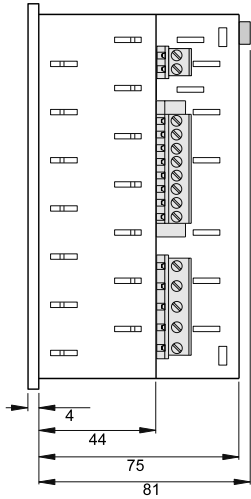

Side view

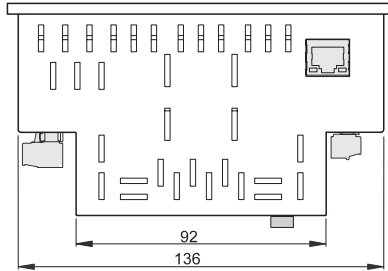

View from below

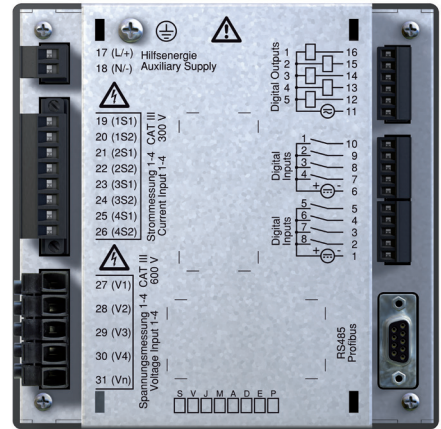

Rear view

Cut out: 138^{+0,8} x 138^{+0,8} mm



Typical connection

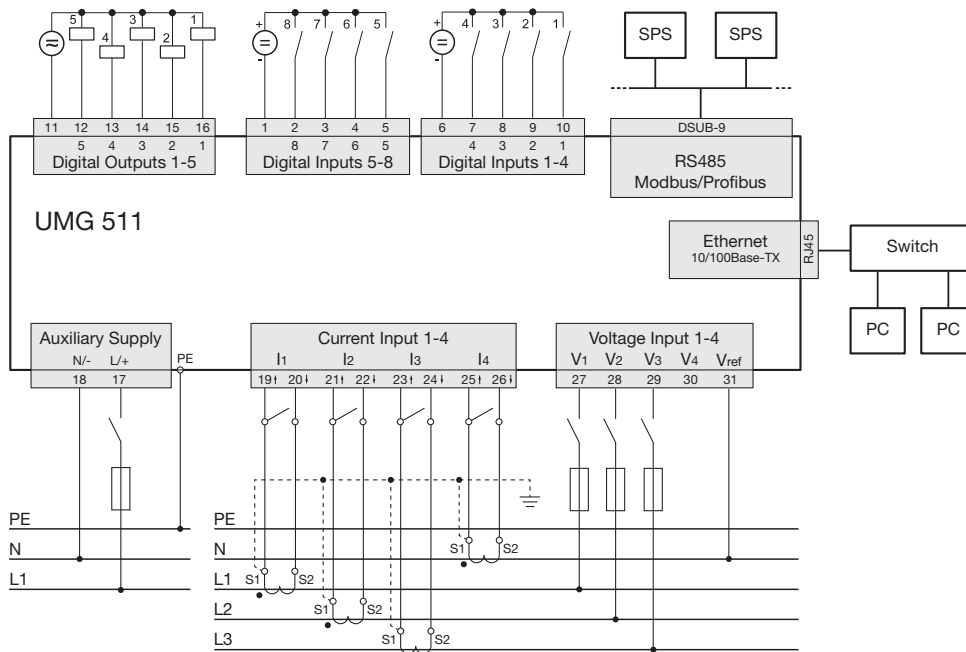



Device overview and technical data

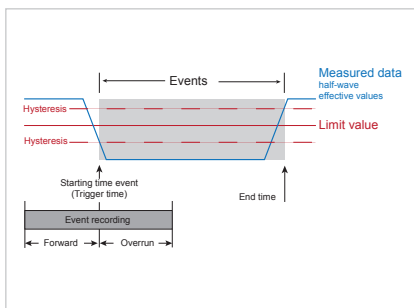

Fig.: The event record consists of a mean value, a minimum or maximum value, a start time and an end time.

	UMG 511	
Item number	52.19.001	52.19.002
Supply voltage AC	95 ... 240 V AC	44 ... 130 V AC
Supply voltage DC	80 ... 340 V DC	48 ... 180 V DC
Item number (UL)	52.19.011	52.19.012
Supply voltage AC	95 ... 240 V AC	44 ... 130 V AC
Supply voltage DC	80 ... 280 V DC	48 ... 180 V DC
Device options		
Emax function (peak demand management)	52.19.080	52.19.080
BACnet communication	52.19.081	52.19.081

General information	
Use in low, medium and high voltage networks	•
Accuracy voltage measurement	0.1 %
Accuracy current measurement	0.2 %
Accuracy active energy (kWh, .../5 A)	Class 0.2S
Number of measurement points per period	400
Seamless measurement	•
RMS - momentary value	
Current, voltage, frequency	•
Active, reactive and apparent power / total and per phase	•
Power factor / total and per phase	•
Energy measurement	
Active, reactive and apparent energy [L1, L2, L4, L3, Σ L1-L3, Σ L1-4]	•
Number of tariffs	8
Recording of the mean values	
Voltage, current / actual and maximum	•
Active, reactive and apparent power / actual and maximum	•
Frequency / actual and maximum	•
Demand calculation mode (bi-metallic function) / thermal	•
Other measurements	
Operating hours measurement	•
Clock	•
Weekly timer	Jasic®
Power quality measurements	
Harmonics per order / current and voltage	1st - 63rd
Harmonics per order / active and reactive power	1st - 63rd
Distortion factor THD-U in %	•
Distortion factor THD-I in %	•
Voltage unbalance	•
Current and voltage, positive, zero and negative sequence component	•
Flicker	•
Transients	> 50 μs
Error / event recorder function	•
Short-term interruptions	20 ms
Oscillogram function (wave form U and I)	•
Ripple voltage signal	•
Under and overvoltage recording	•
Measured data recording	
Memory (Flash)	256 MB
Average, minimum, maximum values	•
Measured data channels	8
Alarm messages	•
Time stamp	•
Time basis average value	freely user-defined
RMS averaging, arithmetic	•

Comment:
For detailed technical information please refer to the operation manual and the Modbus address list.

• = included - = not included

Displays and inputs / outputs	
LCD colour graphical display 320 x 240, 256 colours, 6 buttons	•
Language selection	•
Digital inputs	8
Digital outputs (as switch or pulse output)	5
Voltage and current inputs	each 4
Password protection	•
Peak load management (optionally 64 channels)	•
Communication	
Interfaces	
RS485: 9.6 – 921.6 kbps (DSUB-9 connector)	•
Profibus DP: Up to 12 Mbps (DSUB-9 connector)	•
Ethernet 10/100 Base-TX (RJ-45 socket)	•
Protocols	
Modbus RTU, Modbus TCP, Modbus RTU over Ethernet	•
Modbus Gateway for Master-Slave configuration	•
Profibus DP V0	•
HTTP (homepage configurable)	•
SMTP (email)	•
NTP (time synchronisation)	•
TFTP	•
FTP (file transfer)	•
SNMP	•
DHCP	•
TCP/IP	•
BACnet (optional)	•
ICMP (Ping)	•
Software GridVis®-Basic*1	
Online and historic graphs	•
Databases (Janitza DB, Derby DB); MySQL, MS SQL with higher GridVis® versions)	•
Manual reports (energy, power quality)	•
Graphical programming	•
Topology views	•
Manual read-out of the measuring devices	•
Graph sets	•
Programming / threshold values / alarm management	
Application programs freely programmable	7
Graphical programming	•
Programming via source code Jasic®	•
Technical data	
Type of measurement	Constant true RMS up to the 63rd harmonic
Nominal voltage, three-phase, 4-conductor (L-N, L-L)	417 / 720 V AC ²
Nominal voltage, three-phase, 3-conductor (L-L)	600 V AC
Measurement in quadrants	4
Networks	TN, TT, IT
Measurement in single-phase/multi-phase networks	1 ph, 2 ph, 3 ph, 4 ph and up to 4 times 1 ph
Measured voltage input	
Overvoltage category	600 V CAT III
Measured range, voltage L-N, AC (without potential transformer)	0 ³ ... 600 Vrms
Measured range, voltage L-L, AC (without potential transformer)	0 ³ ... 1000 Vrms
Resolution	0.01 V
Impedance	4 MOhm / phase
Frequency measuring range	15 ... 440 Hz
Power consumption	approx. 0.1 VA
Sampling frequency	20 kHz / phase
Measured current input	
Rated current	1 / 5 A
Resolution	0.01 mA
Measurement range	0.005 ... 8.5 Amps
Overvoltage category	300 V CAT III
Measurement surge voltage	4 kV
Power consumption	approx. 0.2 VA (Ri = 5 MOhm)
Overload for 1 sec.	120 A (sinusoidal)
Sampling frequency	20 kHz

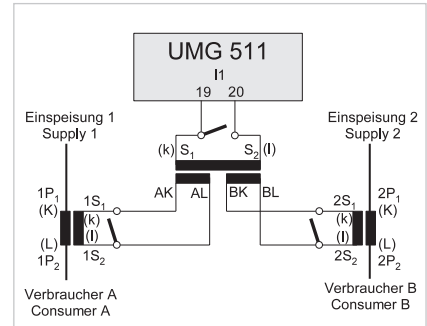

Fig.: Example, current measurement via a summation current transformer

Comment:
For detailed technical information please refer to the operation manual and the Modbus address list.

• = included - = not included

*1 Optional additional functions with the packages Grid-Vis®-Professional, GridVis®-Service and GridVis®-Ultimate.

*2 With UL variants: 347/600 V

*3 The UMG 511 can only ascertain measurement values when a measurement voltage higher than 10 Veff L-N or 18 Veff L-L is applied to at least one voltage measurement input

Digital inputs and outputs	
Number of digital inputs	8
Maximum counting frequency	20 Hz
Reaction time (Jasic® program)	200 ms
Input signal present	18 ... 28 V DC (typically 4 mA)
Input signal not present	0 ... 5 V DC, current < 0.5 mA
Number of digital outputs	5
Switching voltage	max. 60 V DC, 30 V AC
Switching current	max. 50 mA Eff AC / DC
Output of voltage dips	20 ms
Pulse output (energy pulse)	max. 20 Hz
Maximum cable length	up to 30 m unshielded, from 30 m shielded
Mechanical properties	
Weight	1080 g
Device dimensions in mm (H x W x D)	144 x 144 x approx. 81
Battery	Type CR1/2AA, 3 V, Li-Mn
Protection class per EN 60529	Front: IP40; Rear: IP20
Assembly per IEC EN 60999-1 / DIN EN 50022	Front panel installation
Connecting phase (U / I), Single core, multi-core, fine-stranded Terminal pins, core end sheath	0.2 to 2.5 mm² 0.25 to 2.5 mm²
Environmental conditions	
Temperature range	Operation: K55 (-10 ... +55 °C)
Relative humidity	Operation: 0 to 95 % RH
Operating height	0 ... 2,000 m above sea level
Degree of pollution	2
Installation position	user-defined
Electromagnetic compatibility	
Electromagnetic compatibility of electrical equipment	Directive 2004/108/EC
Electrical appliances for application within particular voltage limits	Directive 2006/95/EC
Equipment safety	
Safety requirements for electrical equipment for measurement, regulation, control and laboratory use – Part 1: General requirements	IEC/EN 61010-1
Part 2-030: Particular requirements for testing and measuring circuits	IEC/EN 61010-2-030
Noise immunity	
Class A: Industrial environment	IEC/EN 61326-1
Electrostatic discharge	IEC/EN 61000-4-2
Voltage dips	IEC/EN 61000-4-11
Emissions	
Class B: Residential environment	IEC/EN 61326-1
Radio disturbance voltage strength 30 – 1000 MHz	IEC/CISPR11/EN 55011
Radiated interference voltage 0.15 – 30 MHz	IEC/CISPR11/EN 55011
Safety	
Europe	CE labelling
USA and Canada	UL variants available
Firmware	
Firmware update	Update via GridVis® software. Firmware download (free of charge) from the website: http://www.janitza.com

Comment:
For detailed technical information please refer to the operation manual and the Modbus address list.

• = included - = not included

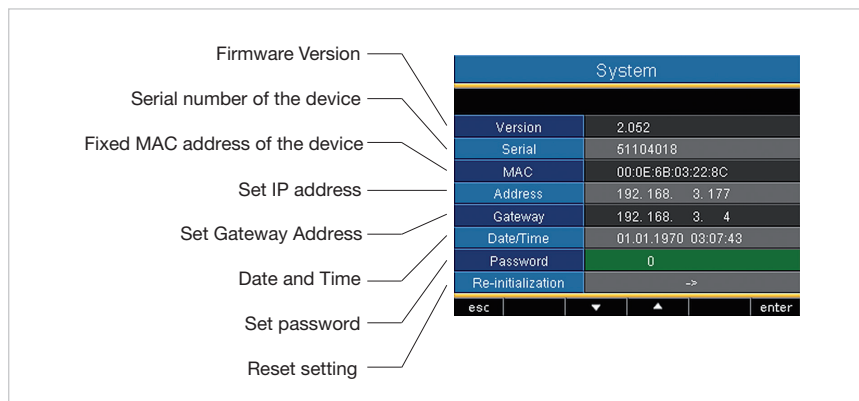
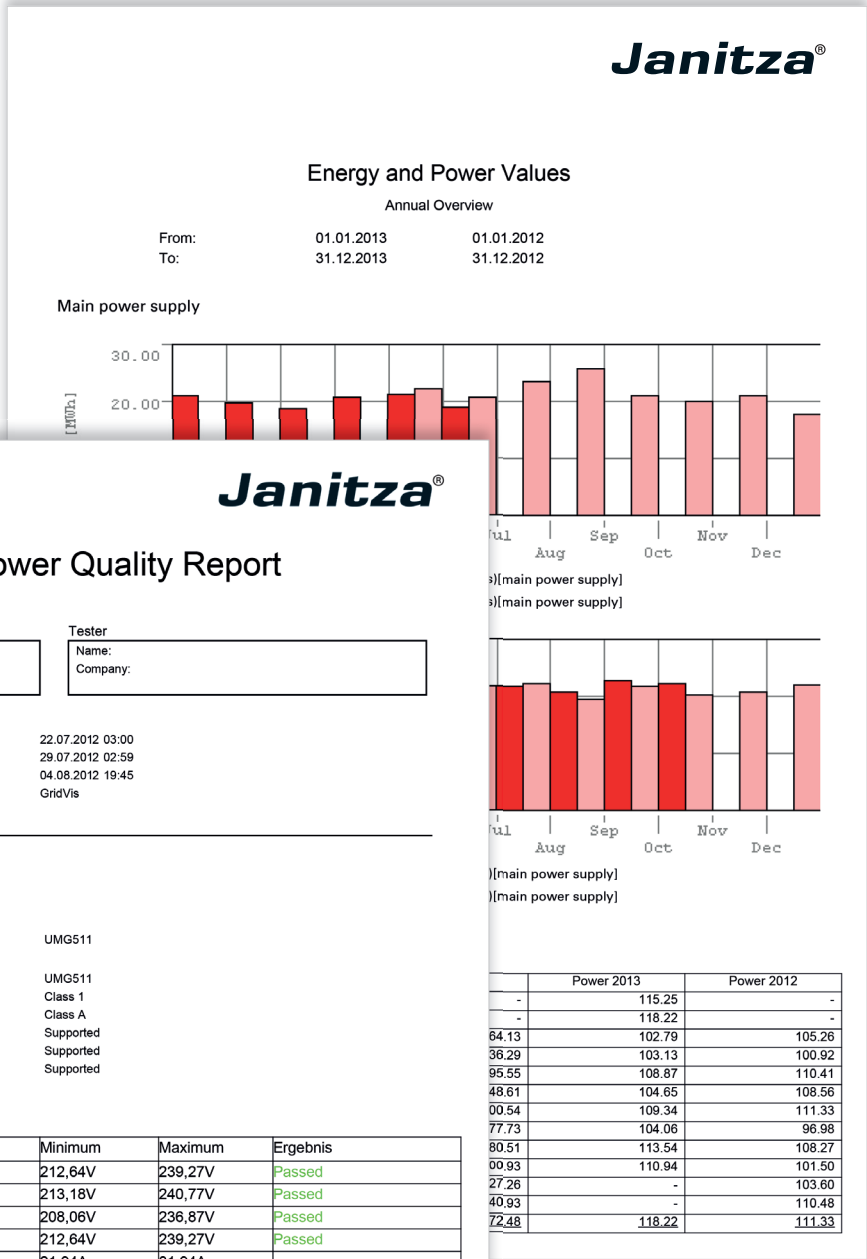

Fig.: User-friendly system of IP addresses, date, time and password



Janitza®

Enhanced Power Quality Report

Customer
 Name:
 Company:
 Location:

Tester
 Name:
 Company:

Start date: 22.07.2012 03:00
 End date: 29.07.2012 02:59
 Datum: 04.08.2012 19:45
 Software: GridVis

Measurement Point: UMG511
 UMG Serial Number:
 Device type: UMG511
 EN 61000-4-7 Class: Class 1
 EN 61000-4-30 Class: Class A
 Flicker: Supported
 Events: Supported
 Transients: Supported

	Minimum	Maximum	Ergebnis
Voltage effective L1, L2, L3	212,64V	239,27V	Passed
Voltage effective L1	213,18V	240,77V	Passed
Voltage effective L2	208,06V	236,87V	Passed
Voltage effective L3	212,64V	239,27V	Passed
Current effective L1, L2, L3	21,94A	81,94A	
THD U L1, L2, L3	1,51%	4,65%	Passed
THD U L1	1,56%	4,43%	Passed
THD U L2	1,65%	4,44%	Passed
THD U L3	1,51%	4,65%	Passed
THD I L1, L2, L3	5,32%	16,65%	
THD I L1	4,05%	16,28%	
THD I L2	4,04%	20,30%	
THD I L3	5,32%	16,65%	
Active Power Sum L1-L3	16,81kW	50,50kW	
Reactive Power Sum L1-L3	-2907,20var	9749,24var	
Apparent Power Sum L1-L3	17,16kVA	51,04kVA	
cos phi(math.) Sum L1-L3	0,96	1,00	
Frequency +-1%	49,83Hz	50,29Hz	Passed
Frequency -6%/+4%	49,83Hz	50,29Hz	Passed
Unbalance Voltage	0,08%	0,89%	Passed
Long term flicker L1(Limit: 1.0)	0,56	1,71	Failed

Enhanced Power Quality Report

Fig.: Automatically generated power quality and energy report