

# **PULSAFEEDER**<sup>®</sup> ENGINEERED PRODUCTS



**Max Flow:** to 3,200 LPH (845 GPH)



**Pressure:** 12 bar (175 PSI)



**Temperature:** 0-45°C (32-113°F)



**Accuracy:** +/- 2% of Set Point

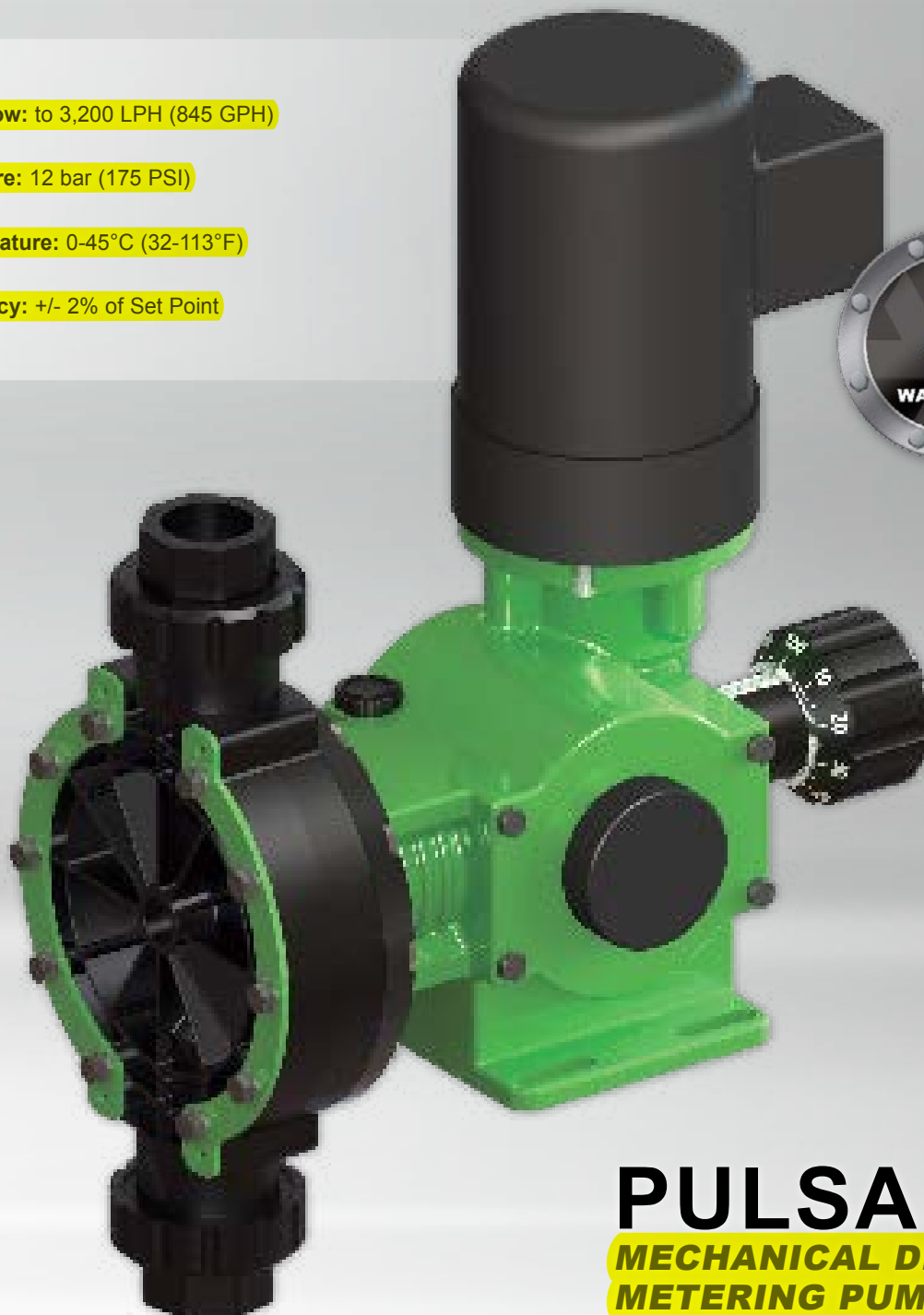

**PULSA GLM**<sup>®</sup>  
**MECHANICAL DIAPHRAGM  
METERING PUMP**

# MECHANICAL DIAPHRAGM METERING PUMP

## PULSAFEEDER EXPERTISE

For over 70 years, Pulsafeeder Inc., a unit of IDEX Corporation, has been a leader in diaphragm and dosing metering technologies. With experience in every kind of fluid handling project, our pumps are made to your specific application. Known for their rugged construction and dependable performance, our products are of the highest level of manufacturing excellence and quality control.

## PULSA GLM® SERIES PUMPS

Our Pulsa GLM® series is a mechanically actuated diaphragm metering pump. Designed to be reliable, robust, efficient, and compact, it features an industrial design to work in just about any application or environment. If you are looking for a high value chemical transfer or dosing metering pump with low cost of ownership, GLM is an outstanding choice. The latest pump series from Pulsafeeder can handle a wide range of flows, pressures and process chemicals.

## MATERIALS OF CONSTRUCTION

**Wet End Materials:** Polypropylene, PVDF, 316L Stainless Steel  
**Diaphragms:** Composite PTFE coated Buna and solid PTFE  
**Check Valves:** Ceramic or Stainless Steel  
**Housing:** Aluminum  
**Base:** Stainless Steel or coated Steel

**Head Adaptors:** Polypropylene or ETFE coated Cast Iron  
**Lubrication:** Oil bath  
**Hardware:** Stainless Steel  
**Coating:** Epoxy paint



## PRODUCT SPECIFICATIONS

- Max Flow:** to 3,200 LPH (845 GPH)
- Pressure:** 12 bar (175 PSI)
- Temperature:** 0-45°C (32-113°F)
- Accuracy:** +/- 2% of set point
- Min Flows:** 0.10 LPH (0.0264 GPH)
- Modular Connections:** tube, threaded, flanged
- Standard Viscosity:** to 1,000 CPS
- NEMA (EEMAC) 4X:** IP 56: outdoor rated (motor not included)
- Stroke Adjustment:** 0-100%, resolution 1.0%
- Ambient Temperature Range:** 0-45°C (32-113°F)
- Suction Lift:** 3m (10 ft.)
- NEMA 7 Class 1:** Div 1 Groups C&D
- Auto-locking Stroke Adjustment**
- Metric UOM First:** 0.4 bar (5 PSI)

## DIAPHRAGM TECHNOLOGY

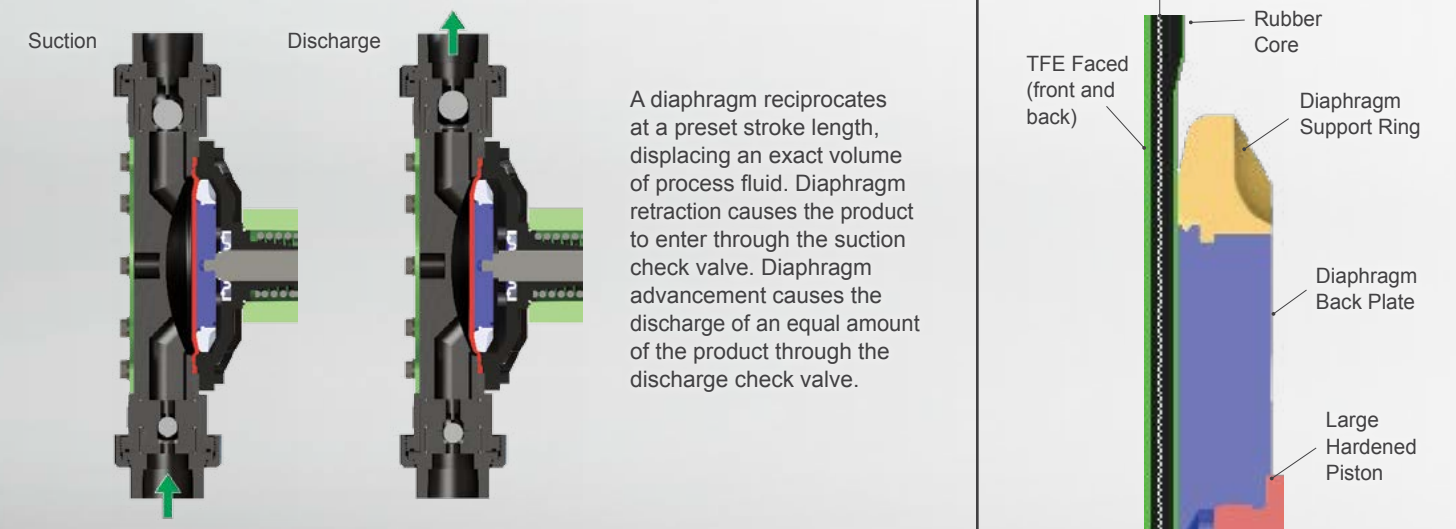

Design Feature	Customer Benefit	Savings
Robust design; > 20,000 hours of run life	Long pump life, low cost of ownership	\$\$\$\$\$
Auto Stroke lock and adjustment	Accurate chemical dosing	\$\$\$\$
Leak free wet end with secondary sealing	Safety, no clean up or environmental risks	\$\$\$\$
Toolless valve and connection options	Fast and easy installation and servicing	\$\$\$
Multiple KOPkit® service options	Proper level of maintenance with minimized cost	\$\$\$
Epoxy paint and ETFE coated heads	Chemical resistant and protected from the environment	\$\$\$
NEMA 4x, IP56 gearbox with upper bearing and seal	Sealed and protected from the environment	\$\$\$
Oil sight glass	Quick maintenance checks	\$\$
Never-seize coupling	Allows for quick and easy removal of motor	\$\$

## MARKETS & TYPICAL APPLICATIONS

### Markets

- Water Treatment
- Wastewater Treatment
- Cooling Towers Boilers
- Power Generation
- Chemical
- Petrochemical
- Food and Beverage
- Pharmaceutical
- Mining

### Typical Applications

- Acids
- Caustics
- Polymers
- Bleaches
- pH Control
- Solvents
- Dyes/Inks
- Catalysts
- Cleaning Agents

# PULSA GLM® — FEATURES & BENEFITS



## GEAR BOX

- Compact and lightweight - saves space and easy to handle
- Completely non-vented gearbox design prevents condensation and ingress of contaminants
- NEMA 4X, IP 56, NEMA 7
- Oversized bearings for long life and reliability
- Robust industrial hex-head SS hardware for proper torques and standardized fittings
- Shielded bearings for added protection



## MOUNTING FEET

- Flat and solid uniform mounting feet - extend outside of the gearbox for stability
- Oversized, slotted mounting holes to accommodate various fasteners
- Balanced center of gravity - pump with motor will not tip over prior to installation or maneuvering



## DRIVE

- Upper worm bearing (sealed) - extends gear and motor life, reduces noise, and maximizes pump efficiencies by ensuring full torque output
- Motor flange drain path redirects liquids away from seal and eliminates pooling/resting on seal or motor shaft connection
- Patent Pending non-metallic never-seize motor coupling prevents sticking or "welding" of worm shaft to motor shaft and allows for quieter long-term operation without coupling wear or knocking sounds
- **Highly efficient, heavy-duty drive train maximizes uptime and reduces total cost of ownership.**



## OIL LUBRICATION

- Oil bath for normal or explosion proof areas, lubricates all internal moving parts to extend pump life
- Easy and accessible oil fill location obstruction free and visible



## WET END & CONNECTIONS

- Standard materials: PVDF, PP, and 316L SS
- Stainless Steel hardware for added chemical resistance
- Modular connections (Tube, NPT, ISO/BSPT)
- Toolless valve removal for easy access and replacement
- 4 bolt tiebar (GLM®7)
- **Factory engineered options: flanged and 4 bolt tiebar plastic connections**



## LEAK FREE HEAD

- **Secure diaphragm sealing technology provides leak free service and chemical containment.**
- **Secondary O-ring seal offers worry free valve sealing and eliminates chemical spray.**
- Large valve "pocket" and interface distributes the loading so it is not affected by pipe stress
- Retention plates ensure pressure containment (hydrostatic and creep elimination), allows for proper head bolt torque without loosening over time
- Increased reagent head bolts (quantities 8-12) to ensure bolt torques are evenly distributed across the retention plates and reagent head to maximize diaphragm sealing.

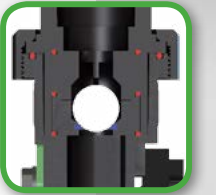

## DIAPHRAGM

- Flat mechanically actuated diaphragm delivers reliable pumping action and long life
- **Double sided PTFE coated composite diaphragms maximizes chemical resistance and diaphragm lubrication**
- Multiple diaphragm sealing beads prevents leakage in industrial applications
- Composite or Solid PTFE diaphragms offered

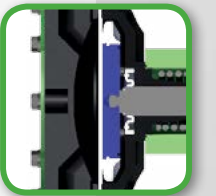

## CHECK VALVES

- Patent Pending spherical uniform velocity valving, limited turbulence, superior solids handling, and auto-flushing. Flow is routed evenly without cavitation concerns
- 3 piece self contained replacement assemblies
- O-ring valve seat (soft seat) for less noise and better solids/slurry handling



## STROKE CONTROL

- 10:1 turndown standard
- 0-100% stroke range (while on or off) - one complete revolution
- **Auto-lock stroke position, drift free - maintaining proper flow**
- **Large, easy to grip knob with intuitive pictures of user friendly instructions**



## SERVICING

- Toolless valve removal for simple servicing
- Multiple KOPkit® options for simple, extended and long-life servicing or prevention preferences
- Easy oil fill and drain
- Oil sight glass for fast inspection of oil and operation
- Ease of maintenance - common hardware, no special tools required
- Never-seize non-metallic motor coupling for fast disconnect



# PULSA GLM® — FLOW & PRESSURE RATING

## FLOW CURVES

Only 50Hz speeds and flows are shown

### DM1

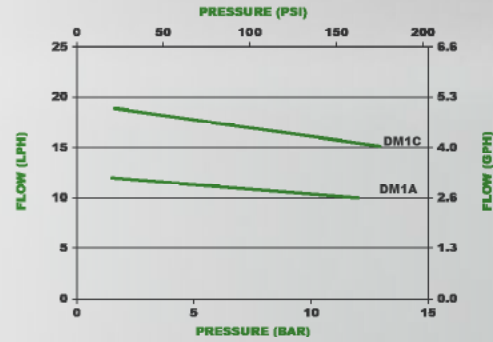

### DM2

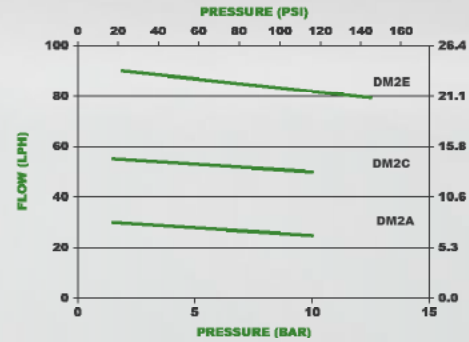

### DM3

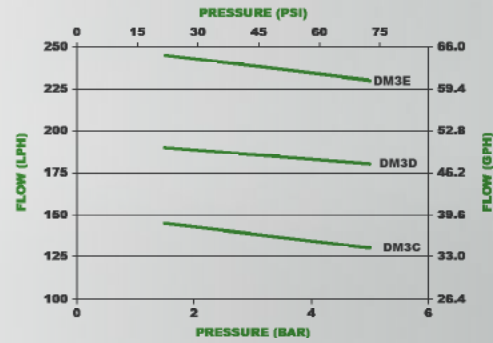

### DM4

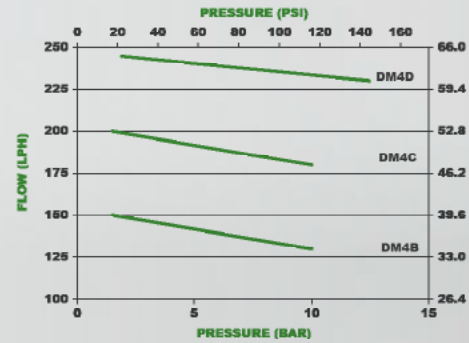

### DM5

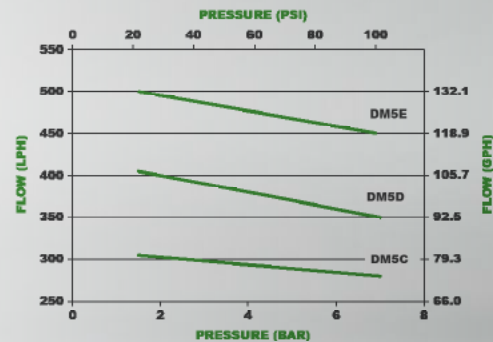

### DM6

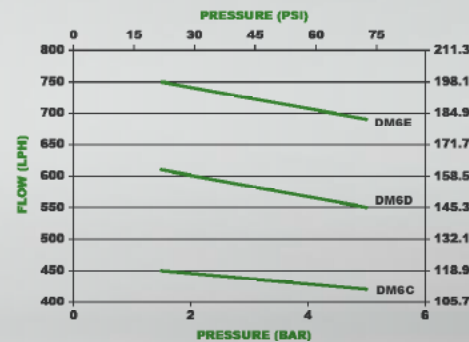

### DM7 SIMPLEX

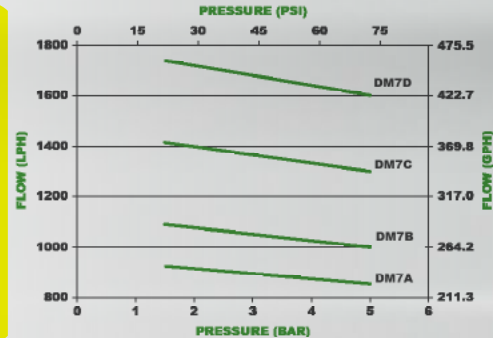

### DM7 DUPLEX

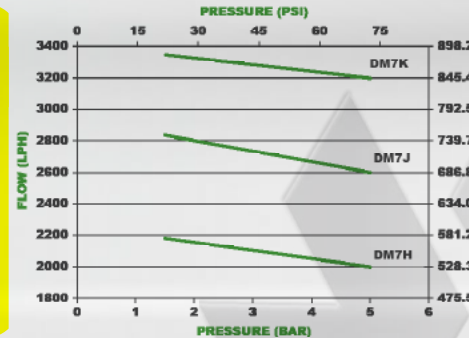

## GLM®1 - 6 PUMP COMPONENTS

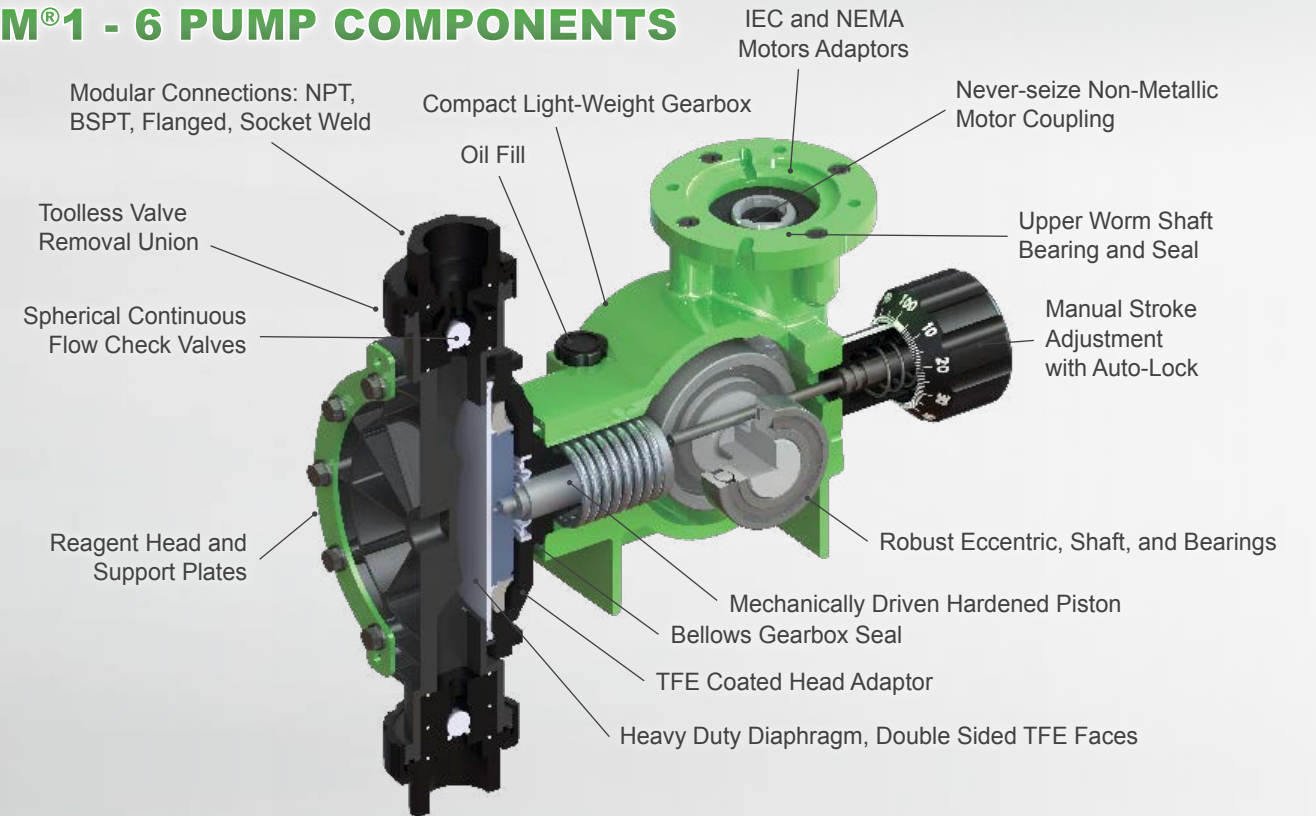

## GLM®7 PUMP COMPONENTS

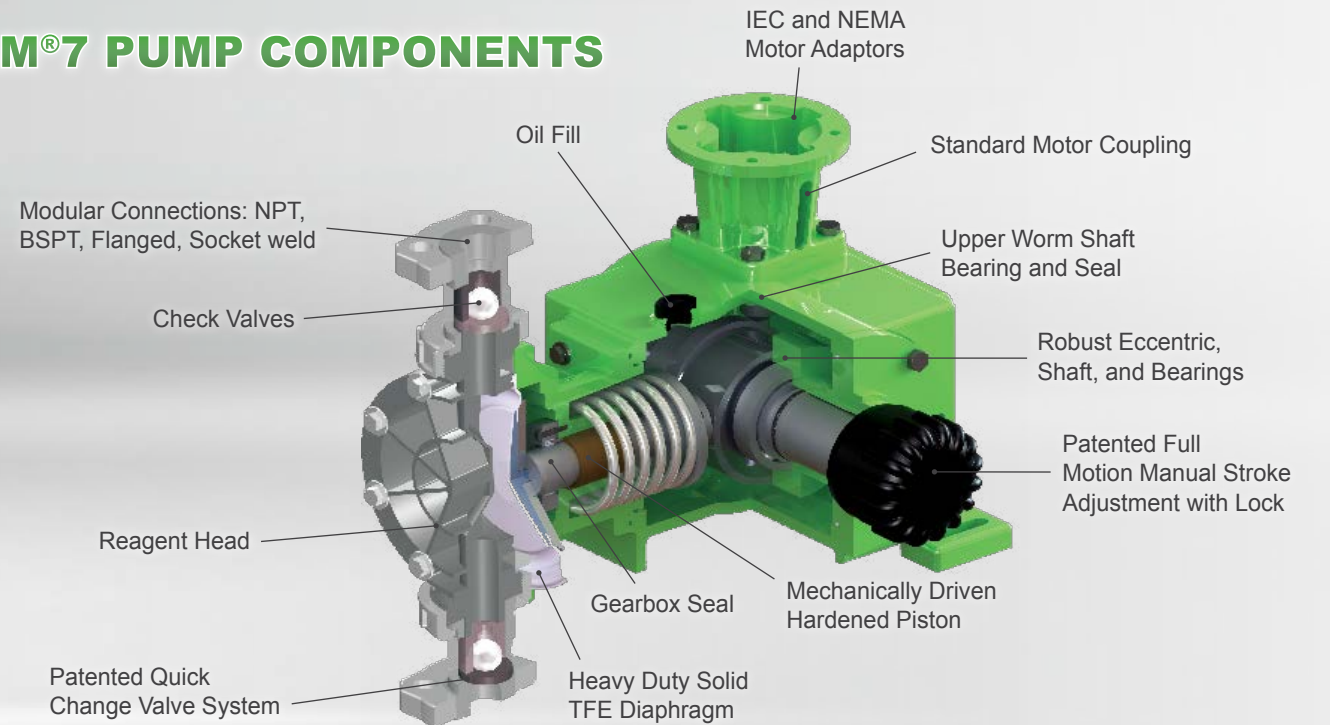

## MODEL TABLE — FLOW & PRESSURE RATINGS

GLM® DM MODEL	50Hz Flow* LPH	60Hz Flow* LPH	Pressure BAR	50Hz SPM @ 1400	60Hz SPM @ 1750	Minimum Motor KW (HP)
DM1A	10	12	12	70	88	0.25 (0.33)
DM1C	15	18		112	140	
DM2A	25	30	10	70	88	0.25 (0.33)
DM2C	50	60		112	140	
DM2E	80	n/a		187	n/a	
DM3C	130	156	5	112	140	0.25 (0.33)
DM3D	180	216		147	184	
DM3E	230	n/a		187	n/a	
DM4B	130	156	10	93	117	0.75 (1.0)
DM4C	180	216		112	140	
DM4D	230	276		147	184	
DM5C	280	336	7	112	140	0.75 (1.0)
DM5D	350	420		147	184	
DM5E	450	n/a		187	n/a	
DM6C	420	504	5	112	140	0.75 (1.0)
DM6D	550	660		147	184	
DM6E	690	n/a		187	n/a	
DM7A	850	1020	5	95	114	1.1 (1.5)
DM7B	1000	1200		111	134	
DM7C	1300	1500		141	176	
DM7D	1600	1900		175	219	
DM7J	2600	3000		141	176	
DM7K	3200	3800		175	219	1.5 (2.0)

\*Flow and pressure ratings based on water-like viscosity.

## PUMP CONFIGURATION STRING

Pump Selection	Code	Description	DM_ _ _ _
PUMP MODEL Positions 1-4	See Model Table	See Model Table for all Pumps	
MOTOR SELECTION Position 5	3	3PH 220/380V IEC Frame, TEFC [50/60Hz]	
	Y	NO MOTOR - IEC Frame (IEC 71 for DM1-6, IEC90 for DM7)	
WET END MATERIALS Position 6	A	316SS Liquid End (See Materials Table)	
	F	PVDF Liquid End (See Materials Table)	
	P	PP Liquid End (See Materials Table)	
CONNECTIONS Position 7	B	BSPT - Not Available on DM7	
	P	NPT with ANSI/DIN Flange Ring (DM7 Only)	
	T	3/8" x 1/2" Tubing Connection (DM1 & DM2 Only)	

## KOPKIT® (KEEP ON PUMPING KIT) CONFIGURATION STRING

	Code	Choice and Description	KD_ _
PUMP SIZE	1	For All DM1 Models	
	2	For All DM2 Models	
	3	For All DM3 Models	
	4	For All DM4 Models	
	5	For All DM5 Models	
	6	For All DM6 Models	
	7	For All DM7 Models	
WET END MATERIAL	A	316SS Liquid End (See Materials Table)	
	F	PVDF Liquid End (See Materials Table)	
	P	PP Liquid End (See Materials Table)	

## WET END MATERIALS

Wet End	Model	Head	Guide	Seat	Valve Cap	Balls	O-rings	O-ringSeat
PP	DM1 - 6	PP	PVDF	PVDF	PP	Ceramic	Viton®	Viton®
	DM7		PP	PP				
SS	DM1 - 7	SS	SS	SS	SS	SS	TFE	N/A

\* Viton® is a registered trademark of DuPont Performance Elastomers.

## DIMENSIONAL DRAWINGS

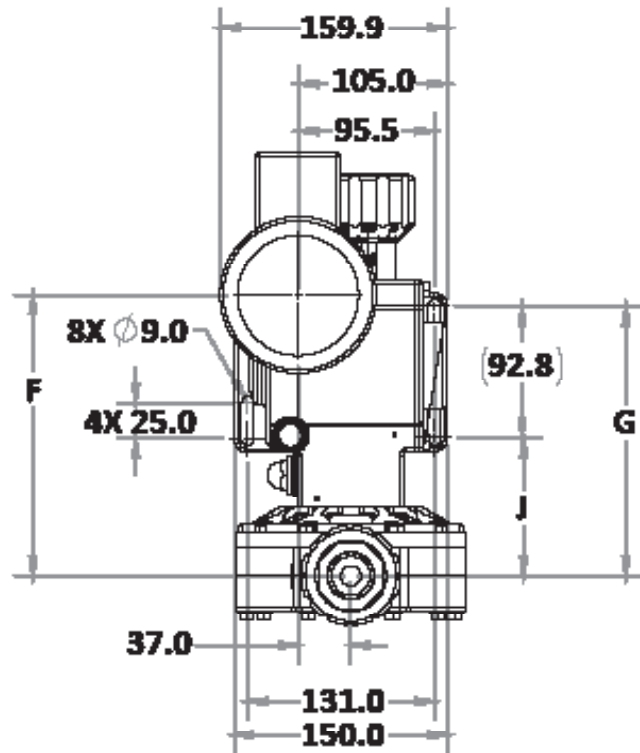

## DIMENSIONAL DRAWINGS DM7 SIMPLEX

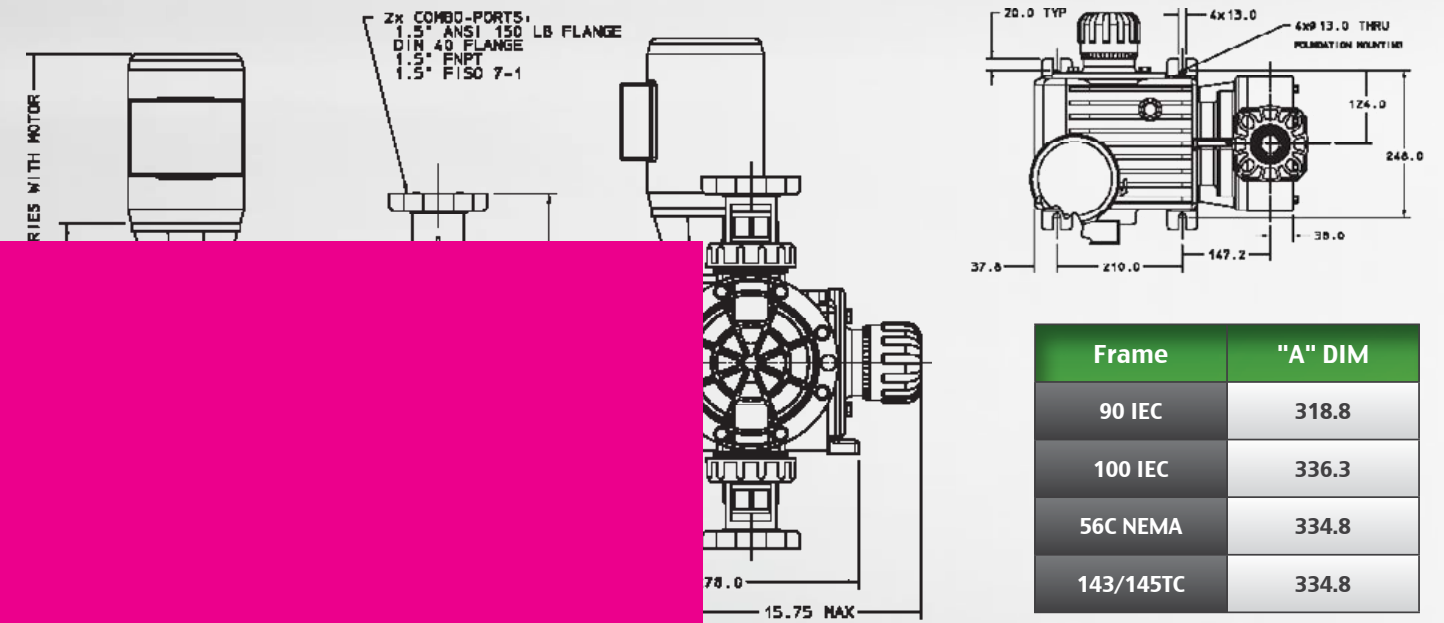

Frame	"A" DIM
90 IEC	318.8
100 IEC	336.3
56C NEMA	334.8
143/145TC	334.8

All Dimension in millimeters

This page is not final. Working on making lines thicker and changing all fonts. This spread will be sent separately in a couple days but wanted to get translation started. Ask Jill with any questions.

Model	DM1	DM2	DM3	DM4	DM5	DM6
A	371	371	426	426	461	461
B	220	220	330	330	400	400
C	31	31	86	86	121	121
D	273	273	283	283	287	287
E	312	312	332	332	343	343
F	187	187	197	197	201	201
G	180	180	190	190	194	194
H	150	150	173	173	187	187
I	87	87	97	97	101	101

All Dimension in millimeters

## DM7 DUPLEX

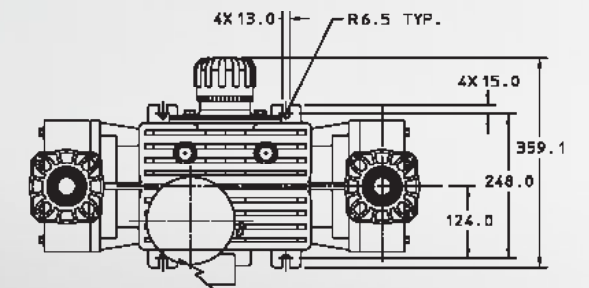

Frame	"A" DIM
90 IEC	318.8
100 IEC	336.3
56C NEMA	334.8
143/145TC	334.8

All Dimension in millimeters

All measurements are for reference only. Subject to change.



# PARTS, KITS, & ACCESSORIES



**Spare Parts** related to your pump are available. If you need to replace a diaphragm, hose or tube, reagent head, or a valve assembly, we have it.



**Pulsation Dampeners** improve pump efficiency by removing pulsations and smoothing pipe flows.



**Pressure Relief Valves** prevent an over pressurization situation from damaging your pump or system.



**Containment Bins** help to prevent and maintain chemical leakage and harmful exposure while servicing your pumping system.



**PULSALube** is the only oil Pulsafeeder recommends for use in our pumps. PULSALube is a superior blend of oils designed to provide optimal lubrication and extend equipment life. It maintains your pump warranty.



**We offer KOPkit®** (Keep on Pumping kits) designed to guard against unnecessary downtime and assure the highest level of efficient and uninterrupted service from your GLM® pump. In the event of a breakdown, one kit will put you back in business fast!

Should we have Michelle change this since this is going to be saved as English version?

