

Isolated Organ & Tissue Systems

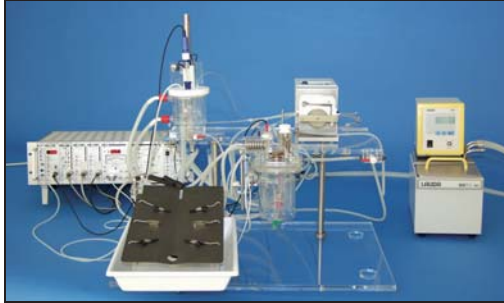

Isolated Heart Size 5, see page K4



Isolated Perfused Lung Size 2, see page K7

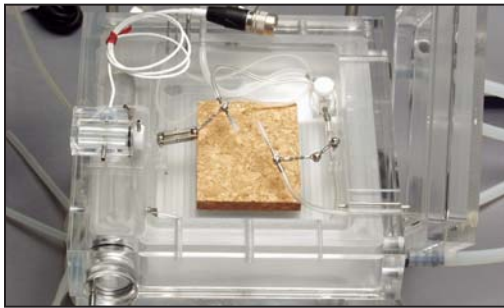

Perfusion System PS-1, see page K8



Schuler Tissue Bath System, see page K12

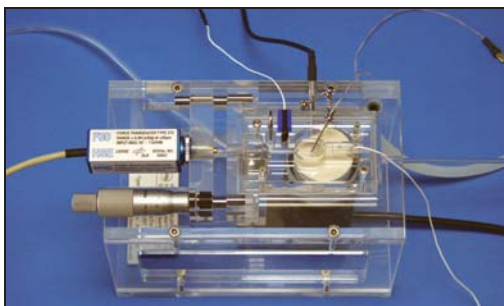

Steiert Organ Bath System, see page K14

- **Isolated Organ and Tissue System Overview**.....see page K2 - K3
- **Isolated Heart Systems**.....see pages K4 - K5
- **Lung Slice Chamber**.....see page K6
- **Isolated Perfused Lung Systems**.....see pages K7 - K8
- **Perfusion System, PS-1**.....see page K8
- **Perfusion System for Isolated Pig Liver or Kidney**.....see page K9
- **NEW Isolated Perfused Rat Mesenteric Bed**.....see page K9
- **Perfusion Bath for Tubular Organs PBTO**.....see page K10
- **Perfusion Bath for Ileum Peristaltic Reflex Studies**.....see page K10
- **Universal Perfusion System, UP-100**.....see page K11
- **Universal Servo Controlled Perfusion System**.....see page K12
- **Schuler Organ Bath System**.....see page K12
- **Graz Tissue Bath System**.....see page K13
- **Mayflower Tissue Bath System**.....see page K13
- **Steiert Organ Bath System**.....see page K14
- **Coleman Superfusion Bath**.....see page K14
- **Superfusion Cascade Bath Type 816**.....see page K15
- **Marsh Ganglion Bath**.....see page K15
- **Universal Perfusion Solution Monitor**.....see page K16
- **Calibration Weights**.....see page K16
- **Glass Reservoirs**.....see page K17
- **Oxygenators**.....see page K18
- **Balloons, Kits, and Accessories for LVP**.....see pages K19 - K21
- **Stimulating and MAP Electrodes**.....see pages K22 - K23
- **Tissue Clips**.....see pages K24 - K25
- **Mini Ball Joint Holders**.....see page K26
- **NEW Thermocirculators**.....see page K27
- **Software for Isolated Heart and Issue**.....see pages K28 - K31
- **Harvard Ltd. Perfusion Systems**.....see pages K32 - K38
- **Harvard Ltd. Tissue Bath Sets**.....see pages K39 - K40

Perfusion & Tissue Bath Systems Overview

Systems Overview

HSE-HA Physiology systems are comprehensive and complete packages for whole animal physiology, isolated and in situ organ and tissue perfusion and tissue bath studies. These systems are used for a wide variety of applications including traditional and safety pharmacology, DMPK, toxicology, respiratory, cardiology, molecular biology and physiology. Each system is modular by design and configured to meet the specific study requirements. The modular design also means that you only need to purchase the components required. Whether you require integration with existing equipment, system upgrades or a complete turnkey package, HSE-HA Physiology systems offer the tools to make your research productive and successful.

We offer the most extensive line of physiological monitoring equipment available anywhere including amplifiers, electrodes, transducers and electrochemical sensors. Parameters include force, displacement, pressure (single ended or differential; cm

H₂O to mmHg), fluid and air flow, ECG (single lead to 12 lead systems), MAP (single or multi focal), EEG, EMG, and continuous side stream perfusate analysis of traditional "blood gas" parameters and electrolytes. Software programmable and traditional stimulators are available to complement our line of amplifiers, electrodes and transducers.

A family of HSE-DAQ system specific software packages (BDAS, ACAD, HAEMODYN, ISOHEART, PULMODYN, PENNOCK) is available to record your primary signals, compute derived parameters, annotate the data set and quickly and easily export focused data sets for analysis. Software modules for advanced analysis, strip chart style printing, automation and control are also available. Packages are delivered pre-configured and ready to run right out of the box; tailored to meet your system configuration and data analysis needs.



PS-1, see page K8

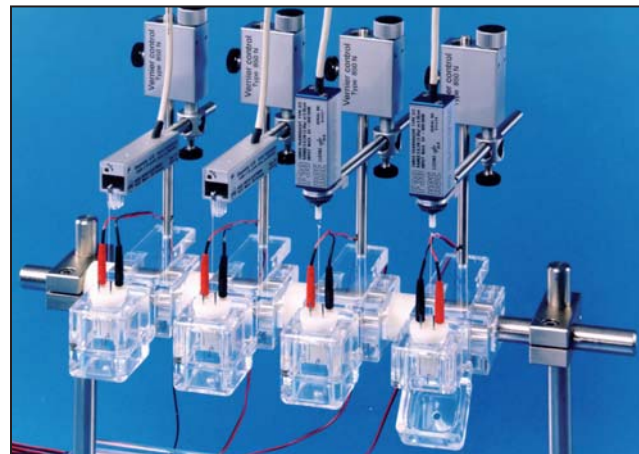

Coleman Superfusion Bath, see page K14

Organ Perfusion

Systems are available for both in-situ and ex-vivo organ perfusion and include setups for heart, lung, kidney, liver, intestine and mesentery. Most include the ability to perfuse under constant flow or constant pressure with a simple turn of a knob. Parameter and system specific electrodes and transducers extend the versatility and functionality of each system.

Tissue Superfusion

When compounds are in short supply due either to high cost or low yield, superfusion systems offer an alternative to typical immersion type tissue studies.

Tissue Bath Systems

We offer an unparalleled line of tissue bath systems. Our line of tissue bath systems includes both horizontal as well as traditional vertical tissue bath systems. Horizontal systems are available for rings and strips as well as cardiac preparations (e.g. papillary muscle and purkinje fiber) and include appropriate tissue supports and platinum plate field stimulation electrodes (when required). Vertical tissue bath systems from a simple Graz setup to a fully automated Schuler tissue bath setup complete the line. Computer controlled automation of tissue pretension, stimulation and flushing requires the use of the HSE-DAQ ACAD software package

Specialty Perfusion Systems and Accessories

Other unique perfusion systems and accessories include: 1) perfusion systems for tubular organs (ileum, blood vessel, vas deferens...), 2) protease based cell extraction, 3) feedback-controlled constant flow or constant pressure equipment, 4) continuous flow through side stream perfusate monitoring, and the innovative Oxystat cellular oxygen consumption monitoring system.

For more information on Perfusion & Tissue Bath Systems, see our website at www.harvardapparatus.com

Perfusion & Tissue Bath Systems Overview

Systems Overview

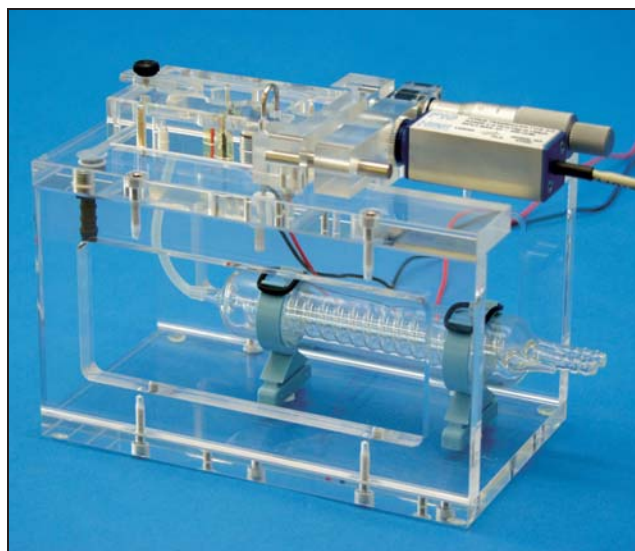

Mayflower Tissue Bath System, see page K13

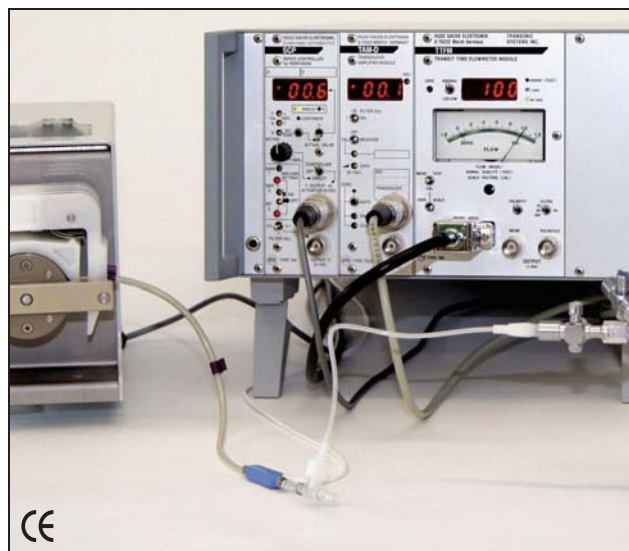

Universal Servo Controlled Perfusion System, see page K12

Isolated Heart Systems

- Isolated Heart for Small Rodents for Murine, Rat and Guinea Pig, IH-SR
- Isolated Heart for Rat, Guinea Pig and Rabbit, Size 5, IH-5
- Isolated Heart for Rodents based on UP-100
- Isolated Heart for Small Pigs, Size 9, IH-9

Isolated Lung Systems

- Lung Slices Chamber
- Isolated Perfused Lung for Mouse, Size 1, IL-1
- Isolated Perfused Lung for Rat and Guinea Pig, Size 2, IL-2
- Isolated Perfused Lung for Rabbit, Size 4, IL-4

Other Isolated Organ/Tissue Systems

- Perfusion System, PS-1 for liver, kidney, etc.
- Perfusion System for Isolated Pig Liver or Kidney
- Isolated Perfused Rat Mesenteric Bed
- Perfusion Bath for Tubular Organs PBTO – Horizontal Tissue Bath for Intestine, Blood Vessel, Trachea Intra- and Extra-luminal or Vas Deferens perfusion
- Perfusion Bath for Ileum Peristaltic Reflex Studies IPR – Horizontal Tissue Bath for Ileum Peristaltic Reflex Studies

Universal Perfusion Systems

- Universal Perfusion System, UP-100 – turnkey system for perfusion isolated organs in-situ or ex-vivo
- Universal Servo Controlled Perfusion System (constant flow or pressure) – Combines perfusion control with a measurement system to maintain either constant perfusion pressure or flow

Tissue Systems

- Schuler Organ Bath System – Vertical Tissue Bath for Strips or Rings
- Graz Tissue Bath System – Vertical Tissue Bath for Strips or Rings
- Mayflower Tissue Bath System – Horizontal Tissue Bath for Strips or Rings
- Steiert Organ Bath System – Horizontal Tissue Bath for Intracellular Recordings on Papillary Muscle or Purkinje Fiber
- Coleman Superfusion Bath – Vertical Tissue Bath used for testing expensive compounds or compounds in limited supply
- Superfusion Cascade Bath Type 816/1 – Vertical Tissue Bath used for testing the effects of released metabolites or mediators on the subsequent tissue preparations in the cascade
- Marsh Ganglion Bath – to test the action of drugs on the synaptic transmission or nerve conduction in preparations like the vagus nerve or the cervical ganglion

Additional Systems

- Universal Perfusion Solution Monitor – Side stream perfusate monitoring system that continuously measures the three most important parameters in the Perfusate: pO_2 , pCO_2 , and pH
- Oxystat - Unique system for monitoring oxygen consumption from cellular suspensions. To prevent the creation of an hypoxic environment during oxygen consumption which can potentially confound the results, oxygen tension is monitored, consumption measured as fresh oxygenated media is exchanged in the chamber, see page M17

Isolated Heart Systems

Isolated Heart For Small Rodents, IH-SR (Murine, Rat and Guinea Pig)

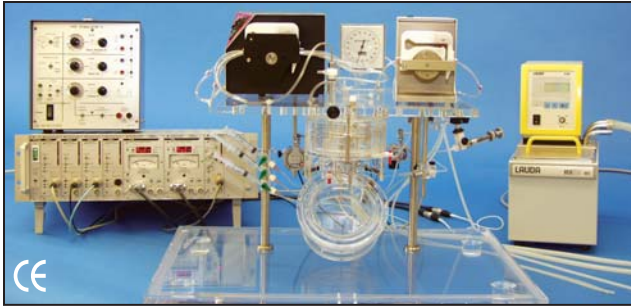

- Constant pressure or constant flow perfusion of isolated rodent hearts with the same apparatus
- Compact unit improved for low volume and high temperature stability
- High perfusion pressure possible (up to 300 mmHg)
- Continuous measurement of heart mechanics and bioelectrical signals
- Langendorff or Working Heart Configurations - Easy to Upgrade
- The special flow resistance and compliance chamber closely mimics the in-vivo afterload
- Applications:
 - Testing inotropic and vasoactive substances
 - Testing cardiac rhythm (chronotropic and arrhythmogenic effects)
 - Assessment of the refractory period
 - Cardiovascular screening of transgenic mice

The IH-SR apparatus has been designed for experiments on the isolated heart of small rodents like rats or guinea pigs, and especially mice. Available in two versions: LH = Langendorff Heart and WH = Working Heart. Both versions allow easy conversion between constant pressure and constant flow conditions. The WH version of the apparatus allows isolated heart experiments in both LH or WH mode. Mode changeover is performed through a few simple manipulations; no additional conversion of the apparatus required. The precision design simplifies system use and minimizes user error.

In LH mode, the coronary vessels are perfused by retrograde flow through the aorta. Under constant pressure conditions, coronary flow can be measured with a flow probe while in constant flow experiments, the perfusion pressure can be measured with a pressure transducer.

Measurement of isovolumetric left ventricular pressure (IVP) (balloon method) is facilitated by custom IVP balloon catheters.

In WH mode the left atrium is cannulated and the heart performs pressure-volume work. Atrial preload is set by a simple fluid column height adjustment. Measurable parameters in WH mode include perfusion pressure, aortic flow, total cardiac output from left atrial flow, atrial preload pressure, IVP pressure via aortic cannulation or ventricular cannulation.

Parameters that can be monitored in either LH or WH modes include ECG, and Monophasic Action Potential. Traditional blood gas measurements (pO_2 , pCO_2 and pH) as well as ion concentrations can also be monitored by pulmonary artery cannulation in rats and guinea pigs but is not available for mice.

Isolated Heart Size 5, IH-5 (Rat, Guinea Pig and Rabbit)



- High perfusion pressure (up to 300 mmHg); easy and fast changes of the perfusion pressure (within seconds)
- Continuous measurement of heart mechanics (contractility, segment lengths), bioelectrical signals (ECG, MAP) and perfusate characteristics (pCO_2 , pO_2 , pH)
- The system can easily be modified to a working heart system, the special flow resistance and compliance chamber mimics closely the in-vivo afterload
- Multiple monophasic action potentials (MAP) and simultaneous multi-lead ECG recording from Isolated Perfused Rabbit heart
- Extended system for hemodynamic and electrophysiology studies
- Applications:
 - Dispersion of ventricular repolarization

The Isolated Heart Size 5, IH-5, apparatus permits the use of hearts of small animals (rodents) as well as larger animals like rabbits. The flow limitation is about 500 ml/min. The perfusate is oxygenated in a 6 liter water jacketed reservoir with multiple ports for recirculation of the perfusate.

The system can be used for work in any one of three methods. The basic system is the retrograde perfusion mode (Langendorff). By setting a defined threshold pressure at the flow resistance, the system works under constant pressure; by increasing the threshold pressure to a super-maximal pressure (300 mmHg) the system works under constant flow. A working heart system can be arranged by using the Left Atrium Cannulating Option. The complete system is mounted on a compact acrylic stand.

The system can also be used to simultaneously record all hemodynamic parameters as well as 8 MAP-potentials and a 12-lead ECG. For this purpose, the IH-5 unit is additionally equipped with a circular holder for 8 MAP-electrodes and with an ECG multi-electrode insert in the heart chamber.

Perfusion System UP-100 for Isolated Rodent Heart



- For isolated mouse, rat, guinea-pig or very small rabbit heart perfusion according to Langendorff
- Constant flow or constant pressure perfusion using the same equipment
- Easy and compact
- Application
 - If isolated heart is only used occasionally
 - For student lab
- Only retrograde perfusion

For the perfusion of the isolated heart according to Langendorff, the universal perfusion system UP-100 can be equipped with a jacketed heart chamber and the additional measurement system for isovolumetric IVP using a latex balloon with spindle syringe for diastolic pressure adjustment. The setup represents a compact unit. It can be used for constant pressure or constant flow perfusion of isolated hearts of mice, guinea pigs, rats and small rabbits as long as the coronary flow is below 100 ml/min. The heart is connected via the aortic cannula to the heat exchanger which acts also as bubble trap. The equipment for measurement of coronary flow or for electrogram can also be adapted. If perfusate containing albumin or erythrocytes is used, the oxygenation can be optimized with the additional oxygenator.

For all Isolated Heart Systems, the Monitoring System is setup using the PLUGSYS Amplifier System, see pages I28 - I58.

The ISOHEART Software is applicable for Data Acquisition, see page K28.

HSE-HA Isolated Perfused Heart Size 9 for Small Pigs

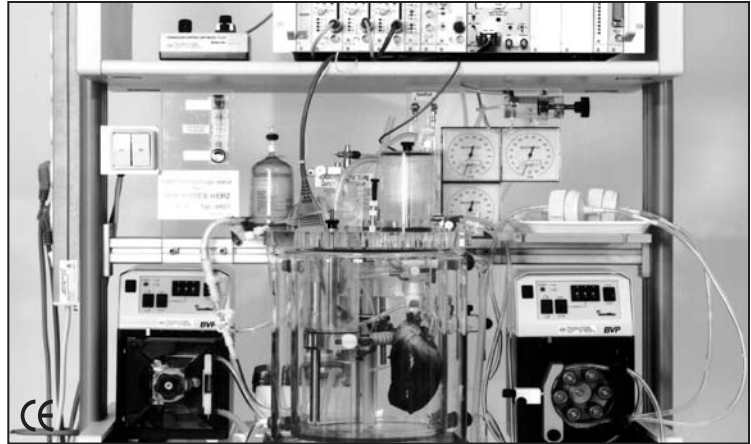

*The Isolated Heart Size 9 has been developed to perform experiments with hearts from small pigs with a body weight up to about 10 kg (heart weight 40 g). The system can be operated in any one of the three methods (Constant Pressure **CP**, Constant Flow **CF**, Working Heart **WH**). The perfusion flow is limited to 500 ml/min for retrograde perfusion and the aortic flow to 1.5 l/min for a working heart system. The system allows standard haemodynamic as well as ischemia-reperfusion studies using saline or erythrocytes containing perfusion solutions. The complete apparatus is mounted on a trolley. It consists of the jacketed heart chamber, its cover with the connections to the heart, pumps, thermostatic circulator and measuring system.*

Special Version:

For heart transplantation and cardioplegia studies, the apparatus is equipped with a special option. With this option the heart can be perfused from a second perfusion circuit in retrograde mode using a different perfusion solution (e.g., perfluorocarbon emulsion). Cardioplegia solutions can be injected or infused through a dedicated port.

- Isolated perfused small pig heart (heart weight up to 40 g) in retrograde perfusion
- Working heart mode, the special flow resistance and compliance chamber mimics closely the in-vivo afterload
- Compact, easy to use
- Special version for cardioplegia studies in heart transplant studies
- Applications:
 - Studies of recovery in heart transplantation
 - Studies of cardioplegia techniques and solutions
 - Evaluation of pacemaker

The main part of the apparatus is the cover of the heart chamber. The aortic block is mounted on this cover. In the working heart version the preload reservoir is mounted on the cover and consequently located into the heart chamber. The large heart chamber serves as perfusate reservoir. The chamber can be moved down during the preparation with a lift-system. The way of functioning is identical to the isolated heart system size 5, see page K4.

Saline perfusion solutions are oxygenated by bubbling in the chamber using a frit. If erythrocytes-containing perfusates are used, a membrane oxygenator as used in the heart-lung machine is necessary.

The measured signals as well as the computed parameters in the different modes are the same for the Isolated Heart Setup Size 9 as for the setup IH-SR 5. The size of the flowprobes must be adapted to the corresponding diameters.

Isolated Lung Slices System

HSE-HA Isolated Lung Slices Chamber

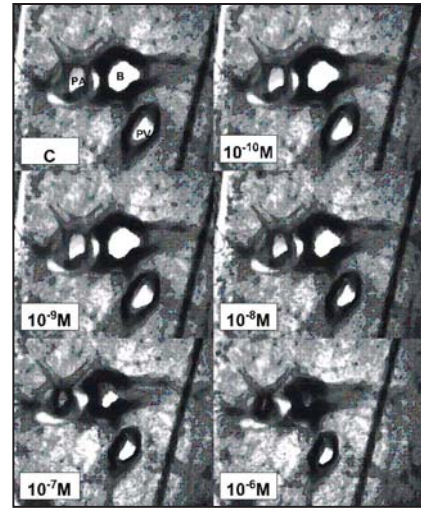
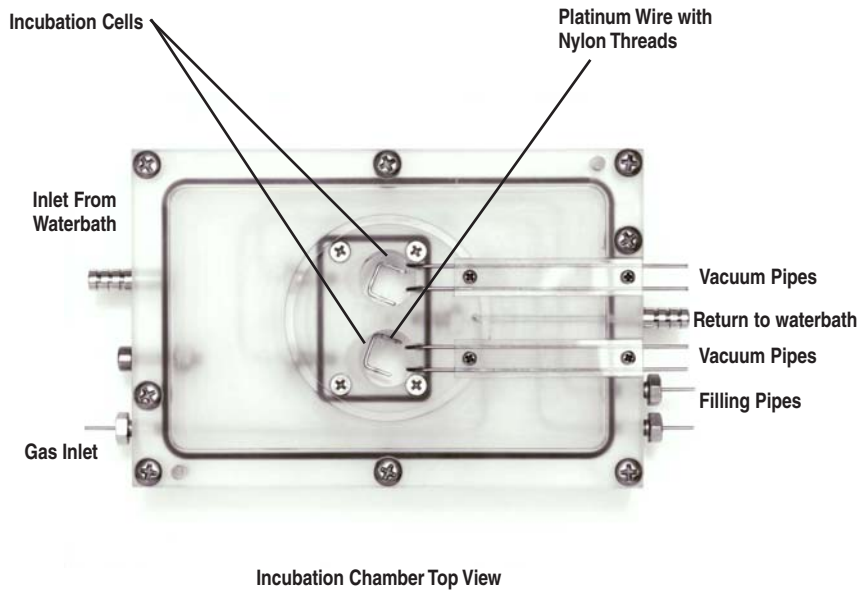

Figure 1. Exposure of a PCLS to increasing concentrations of endothelin-1. Shown is one lung slice containing a small airway (B), a pulmonary artery (PA) and a pulmonary vein (PV). The slice was imaged before (C) and after exposure to increasing concentrations of endothelin-1, ranging from 10^{-10} M to 10^{-6} M.

- Assessment of lung functions under cell culture conditions
- From any species (murine, rat, human)
- Study of airways of different sizes
- Allows to quantify responsiveness of simple airways and simple vessels
- Analyzing ciliary beating frequency

Lung Functions under the Microscope

Precision-cut lung slices (PCLS) offer a novel and unique way to assess lung functions under cell culture conditions. They can be prepared from nearly any species including murine, rat and human lungs. The method allows the study of the response of airways of different size (down to the terminal bronchioles) and to relate these changes in lung functions to gene expression and mediator release. Slices are viable for at least three days. They can be placed under an inverted microscope, where digital image techniques allow to quantify not only the responsiveness of single airways, but also of single vessels. In addition, it is possible to analyze the ciliary beating frequency. More than 20 slices can be obtained from one lung, thus this method is very economical in terms of experimental costs and animal use. Tissue cores are prepared from the lungs filled with agarose solution, after cooling to 4°C. From the cores, slices ($220 \pm 20\mu\text{m}$) are cut using a Krumdieck tissue slicer

The incubation chamber was developed to allow incubation and observation of slices by an inverted microscope. The chamber is made of Polycarbonate. It is connected to a water bath to maintain constant temperature conditions. Two incubation cells are positioned in the center of the chamber. The bottom of the cells is sealed by glass, the cover is made of acrylic glass. The slices are fixed in the incubation cells by positioning them under nylon strings fixed to a bent platinum wire. The incubation cells can be filled with buffer, medium or drug

solutions through the filling pipe. Buffer solution can be removed from the cells over a vacuum pipe. In addition, it is possible to gas the incubation cells in order to use bicarbonate buffered media.

The incubation chamber is placed on the stage of an inverted microscope and warmed to 37°C. The slices are screened for airways and transferred to the incubation chamber. Lung slices are selected for study using predefined criteria (Martin et al. 1996). Airways and vessels are focused, and finally the images are analyzed by image analysis software (e.g., Optimas or Metamorph).

Example of an Application

As an example Figure 1 shows exposure of a slice to increasing concentrations of endothelin-1. Shown is a lung slice containing an airway (B), a pulmonary artery (PA) and a pulmonary vein (PV). The pulmonary artery and the airway contracted almost completely, while the pulmonary vein area decreased to only 50% of its initial area. These responses are now easily quantified by digital imaging technique.

It is a distinct advantage of this technique that in many ways precision-cut slices can be treated like a cell culture. Thus, the slices can be incubated under various conditions and gene as well as protein expression or mediator release be determined. In contrast to cell culture models, in slices the anatomical structure of the lung is largely maintained, so that the functional consequences of gene expression and mediator release can be evaluated.

Catalog No.	\$	Product
BS4 73-2370		Lung Slices Chamber
BS4 73-0125		Thermostatic Circulator E 103, 230V AC, see page K27
Accessories		
BS4 73-2802		Thermostatic Circulator E 103, 115V AC, see page K27
BS4 73-0113		Roller Pump Reglo Analogue ISM 827, 4 Channels, 0.002 to 30 ml/min

Isolated Perfused Lung for Mouse Size 1, IL-1

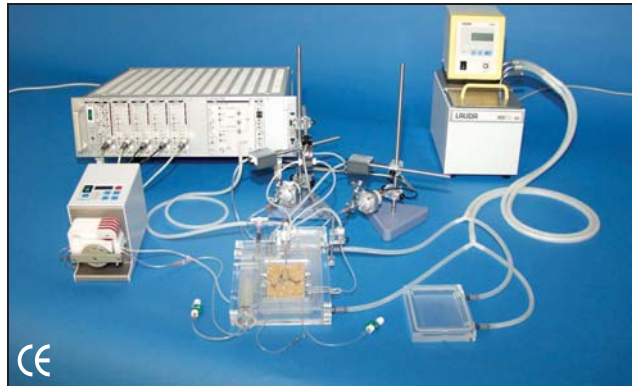

- Investigation of ventilation and perfusion in the isolated mouse lung
- Non-damaging in-situ preparation
- Negative-pressure ventilation similar to in-vivo condition
- Regular induction of deep inspiration (sigh, augmented breath)
- Pneumotachometer and air humidifier with small dead volume
- Continuous measurement of respiratory mechanics (tidal volume, airway resistance, dynamic compliance) and perfusate characteristics (pressure, lung vascular resistance, pO_2 , pH)

Most of the studies with isolated perfused lungs have been performed with lungs obtained from rats, guinea pigs, rabbits or dogs. The interaction of the immune system with the lung is currently an area of great interest. The mouse is the best characterized rodent species with respect to its immune system. Immunologic probes such as antibodies and cytokines are more widely available for mice versus other species. To facilitate studies on the interaction of the lung and the immune system, an apparatus for perfusing and ventilating mouse lungs has been developed. This apparatus is also suitable for studying the respiratory system of knock-out mice.

Ventilation

The lung is placed in the artificial thoracic chamber and ventilated at negative pressure. It is connected through the tracheal cannula to the pneumotachometer for measurement of respiratory flow. The respiration rate, the inspiratory and the end-expiratory pressure can be adjusted by separate controls (Positive ventilation using a regular Minivent ventilator is also possible).

Perfusion

The pulmonary artery is cannulated to provide perfusion. The perfusate is passed by means of a roller pump at constant flow through the heat exchanger, through a bubble trap to the pulmonary artery and finally into the lung vascular bed. The perfusate outflow is usually provided by cannulating the left atrium of the heart.

*Monitoring System is setup using the PLUGSYS Amplifier System, see pages 128 - 158.
Evaluation of respiratory mechanics using PULMODYN software.*

Isolated Perfused Lung for Rat/Guinea Pig Size 2, IL-2

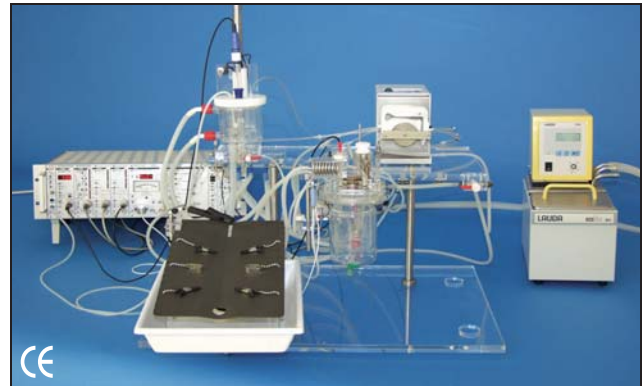

- Optimized in-situ preparation
- Negative-pressure ventilation to mimic more closely the in-vivo situation
- Regular induction of hyperinflation of the lung (sigh, augmented breath)
- Several perfusion modes using buffer solution or blood are available:
 - Constant flow perfusion
 - Constant pressure perfusion
 - Dual perfusion system(constant flow or constant pressure can be selected)
- Continuous measurement of lung mechanics (tidal volume, resistance, compliance), and perfusate characteristics (pressure, flow, pO_2 , pCO_2 , pH)
- Continuous measurement of lung weight (Edema)

Ventilation

The lung is placed in the artificial thoracic chamber and ventilated at negative pressure, it is connected via the tracheal cannula to the pneumotachometer for measurement of respiratory flow. The humidified ventilation medium (air or gas mixture) is constantly flowing past the distal end of the pneumotachometer.

Perfusion

Lungs can be perfused by either constant flow or constant pressure. Although constant flow perfusion may mimic the in vivo situation more closely, it has the disadvantage that hydrostatic edema becomes inevitable during vasoconstriction. Constant pressure perfusion permits higher perfusate flow rates since vasoconstriction decreases perfusate flow and hydrostatic edema is less likely to occur.

Can be configured in one of three different perfusion modes:

1. Constant Flow Perfusion
2. Constant Pressure Perfusion
3. Dual System to Switch from Constant Flow to Constant Pressure and Vice Versa

Lung Weight Changes

Continuous measurement of weight changes of the lung is required for monitoring edema formation. This is possible during negative pressure ventilation inside the thoracic chamber by using the HSE-Edema balance LS 30 (weight transducer) (BS4 73-0593), range ± 30 g, displacement 2 $\mu\text{m}/\text{gram}$. Weight changes induced by raising or lowering the perfusion pressure can be used to assess vascular permeability by determining the filtration coefficient.

Isolated Lung and Other Organ Systems

HSE-HA Isolated Perfused Rabbit Lung Size 4

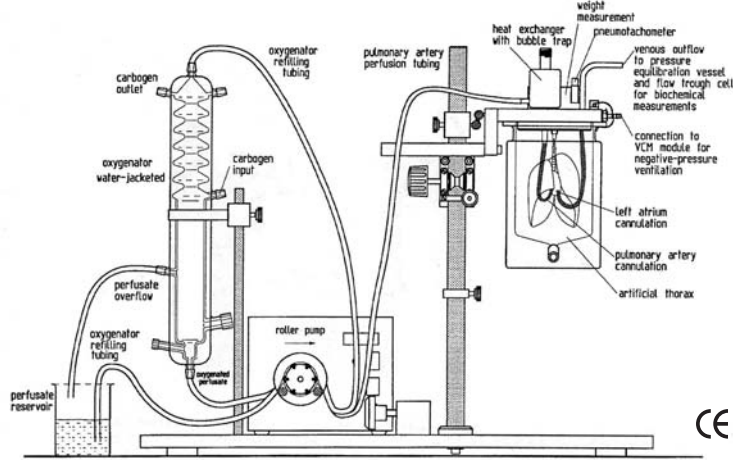

Front view of apparatus in normal working position, with artificial thoracic chamber (water-jacketed glass chamber) positioned underneath cover, which is now in horizontal position

- Investigation of ventilation and perfusion in the isolated rabbit lung
- Optimized in-situ preparation
- Negative-pressure ventilation to mimic closely the in-vivo situation
- Regular induction of hyperinflation of the lung (sigh)
- Perfusion under constant flow condition using buffer solution or blood
- Continuous measurement of lung mechanics (tidal volume, resistance, compliance), and perfusate characteristics (pressure, $p\text{CO}_2$, $p\text{O}_2$, pH)
- Continuous measurement of lung weight changes (Edema)

Ventilation

When the lung is placed in the artificial thoracic chamber and ventilated at negative pressure, the ventilation head is removed and replaced by the pneumotachometer for the measurement of respiratory flow. The ventilation medium (air or gas mixture) is constantly flowing past the distal end of the pneumotachometer. The breathing frequency can be varied between 30 and 60 breaths/min. In addition, the inspiratory time as a percentage of each breath, can be set between 10 and 90% in 10% steps. The end-inspiratory, end-expiratory, and deep breath (hyperinflationary) negative pressure can be set individually. A deep breath is usually induced every 5 to 20 min.

Constant Flow Perfusion

The constant flow rate of perfusate into the pulmonary artery is determined by a roller pump. The perfusate is stored in a water-jacketed container to maintain constant temperature. Aeration is provided to keep the pH constant. A

heat exchanger and a bubble trap are placed next to the pulmonary artery connection for exact adjustment of the perfusate temperature just before the thorax chamber and to prevent air bubbles entering the lung.

Different perfusates can be provided in turn by transferring the suction tube from one reservoir to another; there is no need for prior aeration or temperature control. The use of oxygen-sensitive test substances raises few problems since the contact time with the high oxygen concentration is minimized. It is also possible to vary the gas mixture rapidly during the study.

A Constant Pressure Perfusion System is optionally available. Please call for details.

Lung Mechanics

The pressure inside the thoracic chamber is measured with a MPX pressure transducer. Air flow is determined with the pneumotachometer connected to a Validyne differential pressure transducer DP 45-14. The volume is derived from the air flow by integration. The calculation of pulmonary compliance and resistance needs a computer controlled data acquisition system (HSE-HA Pulmodyn).

Perfusion System, PS-1



- Complete perfusion system ready for use for liver, kidney, etc.
- Compact arrangement
- Organ is in warm and moist environment during perfusion
- Optimized temperature control of perfusate and organ
- Perfusion can be performed at constant pressure or constant flow without involving any modification of apparatus
- Perfusion pressure can be set up to 300 mmHg by means of rotary control
- Perfusion flow range up to approximately 60 ml/min

The PS-1 system is an optimized version of the UP-100 when only ex vivo perfusion using a moist chamber is required. The organ is located in a moist chamber during perfusion, a warm and moist atmosphere. The moist chamber can be equipped with bubble traps and flow probes directly at the entry of the organ. Perfusion is possible either under constant pressure or under constant flow conditions.

Additional items are available to suit the scope of the intended experiments. These items include:

- Air vessel for reducing the pulsation produced by the roller pump
- Pressure measuring system for evaluating the exact perfusion pressure
- Flow measuring system for evaluating the flow during experiments under constant pressure conditions
- Measuring system for continually evaluating the partial oxygen pressure in the perfusate, for determining oxygen consumption

Applications for ex vivo perfusion using a moist chamber of liver, kidney, mesenteric bed...

- Test of vasodilative drugs
- Studying metabolic processes
- Neural vascular tone
- Organ preservation for transplant

Other Organ/Tissue Systems

NEW HSE-HA Perfusion System for Isolated Pig Liver or Pig Kidney

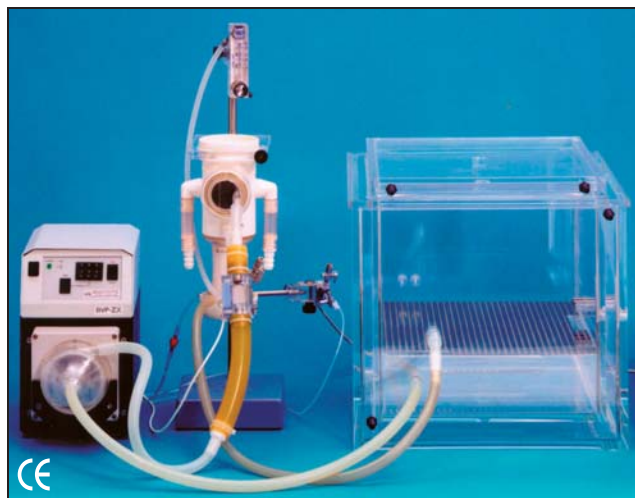

- For use in physiological or pharmacological research for the perfusion of a pig liver or kidney with blood or erythrocyte containing perfusate

Basic System

The pig liver to be perfused is placed in a moist, thermostated chamber and perfused with blood through the portal vein under constant-flow conditions.

A centrifugal pump with a gentle action on blood is employed to reduce hemolysis; it is controlled by an electronic controller (SCP) so that the apparatus can be operated under constant-flow conditions. The system can also operate under constant-pressure conditions. Flow control requires that the flow is measured by means of a flow probe (16N) and a flowmeter (TTFM). The pressure should also be measured to monitor the experiment. This requires a pressure transducer (P75) and a bridge amplifier (TAM). A suitable oxygenator is employed for oxygenating and warming the blood; it can be of a type used in human medicine, e.g. Terumo Capiox SX10®.

Components required

The following items are required for operating the apparatus:

- Thermostated moist chamber Type 869/2
- Circulating thermostat of approx. 3 liter capacity, distilled water and an anti-algal agent, e.g. Thermoklar
- Pump with electrical control. For blood we recommend a Pump Drive BVP-ZX with centrifugal pump head, see the Pump Section A
- Servo Controller for Perfusion (SCP) Type 704, see page K12
- Flowmeter (TTFM) with flow probe (16N), see pages J6 and J7
- Recommended: pressure transducer (P75), see page J3 and bridge amplifier (TAM-D), Section I of this Catalog
- Oxygenator with heat exchanger, e.g. Terumo Capiox SX10®
- Source of Carbogen for aeration. Central supply or Carbogen cylinder with pressure reducing valve

Additional monitoring equipment can be added to the system as required to create a custom, application specific, turn key system for your unique research needs.

上海达域仪器有限公司 电话: 021-56479651 网址: www.dayulab.com 邮箱: Sales@dayulab.com
U.S. Toll Free: (800) 272-2775 • Fax: (508) 429-5732 • Online: www.harvardapparatus.com

NEW Isolated Perfused Rat Mesenteric Bed

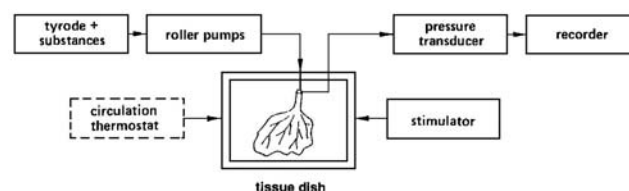
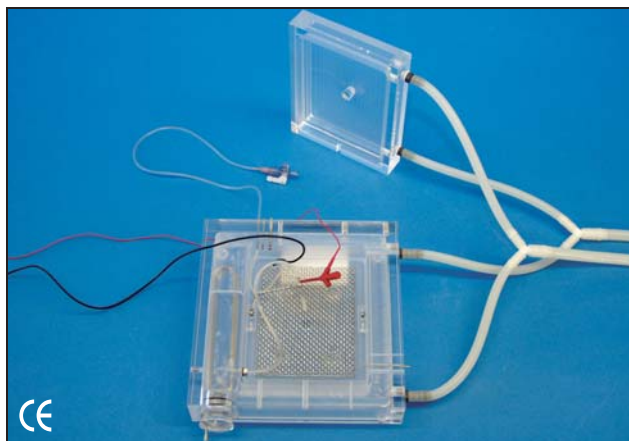

- For investigating the tone of small blood vessels under the effect of vasoactive substances
- Compact arrangement
- Organ is in warm and moist environment during perfusion
- Electrical field stimulation capabilities

The rat hind leg and the rabbit ear are conventional preparations for investigating the tone of blood vessels under the effect of vasoactive substances in the peripheral vascular bed, either at constant perfusion pressure or at constant flow. Both set-ups suffer from the disadvantage that the measurement is affected by early edema formation. In the rat, the mesenteric

circulation receives approximately 20% of the cardiac output; its regulation may therefore contribute significantly to the systemic blood pressure and circulating blood volume. The presence of arterioles, i.e. the most important vessels in the regulation of vascular resistance, renders the mesenteric bed an important preparation for the study of vascular physiology, pathophysiology and pharmacology.

The organ bath for the rat mesenteric bed consists of a moist chamber with cover, both water jacketed. The mesenteric tissue is placed into the moist chamber on a stainless steel mesh which also acts as anode during electrical stimulation. The superior mesenteric artery is cannulated (steel cannula) and perfused at constant flow (e.g. 5 ml/min) through a roller pump via a heat exchanger included in the moist chamber. The test drug is introduced through a separate roller pump or a syringe pump directly before the vascular bed preparation. The perfusion pressure is measured in a branch before the stainless steel cannula.

For electrical stimulation, the Mesenteric Bed is placed on a stainless steel grid and a metal clip is attached to the aorta section near the steel cannula.

References:

- 1) Cusma-Pelógia, N. et al.: Endothelium Inactivation in In Vitro Perfused Vascular Beds - Comparison of Methods. *J. Pharmacol and Toxicol. Methods* 29, 157-163 (1993)
- 2) Potenza, M.A. et al.: Vasodilation induced by Capsaicin in Rat Mesenteric Vessels is probably independent of Nitric Oxide Synthesis. *Pharm. Res.* 30, 253 (1994)

Other Organ/Tissue Systems

HSE-HA Perfusion Bath for Tubular Organs (PBT0)

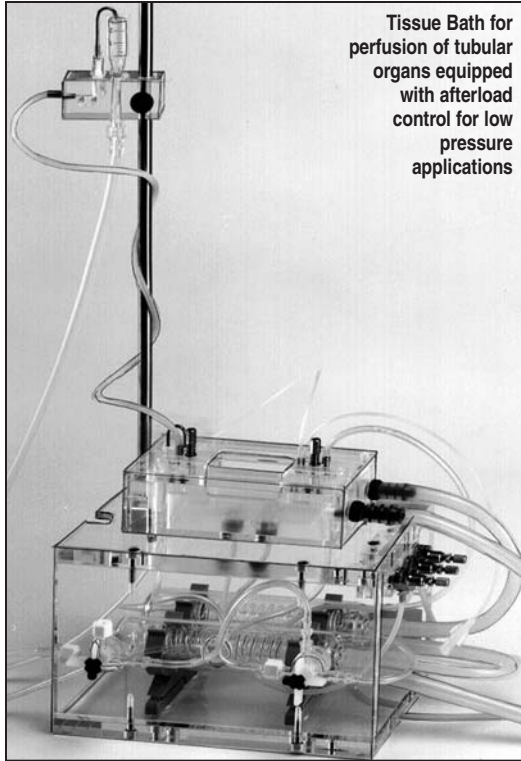

Tissue Bath for perfusion of tubular organs equipped with afterload control for low pressure applications

Tissue Bath Type 813/6 Perfusion of Tubular Organs

- Perfusion of tubular organs (trachea, blood vessels, intestines)
- Individual solutions for intraluminal perfusions and extraluminal superfusion
- Controlled perfusion pressure

This Tissue Bath has been designed for the studying of perfused tubular organs such as trachea, blood vessels, intestines and vas deferens. Individual solutions can be used for intraluminal perfusion and extraluminal superfusion. Two roller pumps are needed, one for intraluminal

constant flow perfusion and the second for extraluminal superfusion. The effective intraluminal perfusion is generated by an adjustable afterload control system. A differential pressure transducer is used to measure the intraluminal pressure difference at the proximal and distal end of the organ. The tissue bath is a water-jacketed Plexiglas bath. The holder for the cannulae can be removed from the main bath during the cannulation of the segment of tubular organs. Four different sizes of cannulae are available. The cannulae are fixed on sliding holders to optimize the distance between the cannulae to adapt to the individual length of the organ avoiding any slackness of the tissue. There are two afterload control systems available. One for low pressure applications (0 to 20 mmHg) and the second for high pressure applications (10 to 300 mmHg). The unit is supplied with four different interchangeable adapters for use with vessels or organs with the following diameters: 1.5, 2.5, 3 and 4 mm. For smaller vessels customized stainless steel cannulae can be made on request. For micro-vessels, glass capillary pipettes pulled to the required diameter can be connected to the adapter cannulae using a silicone tube collar. Maximum vessel length is 50 mm.

上海达域仪器有限公司 电话: 021-56479651 网址: www.dayulab.com 邮箱: Sales@dayulab.com

HSE-HA Perfusion Bath for Ileum Peristaltic Reflex Studies (IPR)

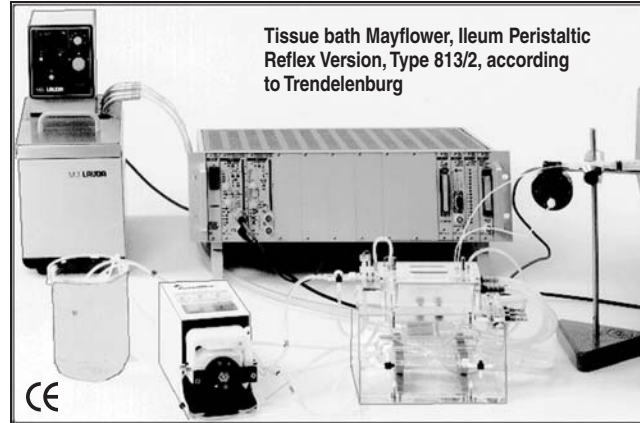

Tissue bath Mayflower, Ileum Peristaltic Reflex Version, Type 813/2, according to Trendelenburg

Tissue Bath for Perfusing Ileum

- Basic test in gastro-intestinal research
- Peristaltic reflex in guinea pig ileum
- For studying emptying phase of peristaltic reflex

This tissue bath has been designed for studying the peristaltic reflex in the guinea-pig ileum. The circular muscle contraction which propels the contents of the ileum from aboral to anal direction is induced by the increase of the intraluminal pressure up to a threshold point.

The tissue bath is a water-jacketed Plexiglas bath. The holder for the cannulae can be removed from the main bath during the preparation. A 4 to 5 cm long segment of ileum, where the mesenteric has been removed and which has been flushed is cannulated in the oral and aboral ends and tided. Three different sizes of cannulae are available. The cannulae are fixed on sliding holders to optimize the distance between the cannulae and adapt to the individual length of the ileum avoiding any slackness of the tissue. The inflow is controlled by means of a peristaltic pump with a flowrate of about 0.5 ml/min. The direction of the perfusion flow must meet the physiological way. The outflow can be switched using a stopcock from a level equivalent to the level of the bath to a level of about 3 cm above the level of the fluid in the bath. The peristaltic reflex is induced by changing the position of the outflow stopcock. When it is in position 'peristalsis', the pressure increases slowly resulting in a distention of the ileum until the pressure threshold level is reached. At this time the emptying phase is started as a visible contraction of the circular muscle moving from the oral to the aboral side.

The intraluminal pressure is recorded from the oral side by a pressure transducer and the appropriated amplifier and recorder. The pressure transducer must be sensitive enough to reproduce the small threshold point of 1 to 2 cmH₂O

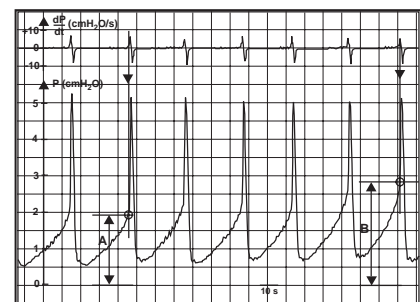

HSE-HA Universal Perfusion System UNIPER UP-100

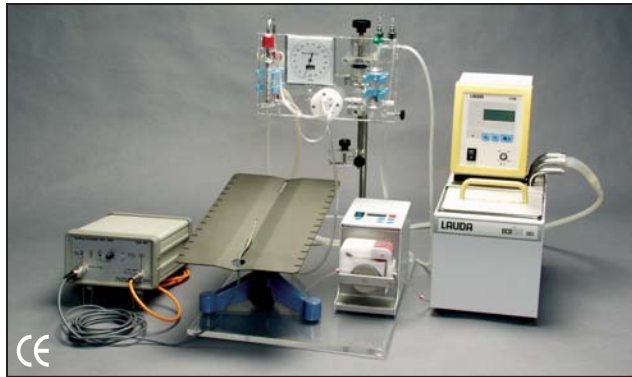

- Turnkey system for perfusing isolated organs in-situ or ex-vivo
- Ideal for perfusing isolated organs such as:
 - Liver
 - Heart
 - Kidney
 - Mesenteric bed
 - Rabbit Ear
 - Rat hind limb
- Perfusion can be performed at constant pressure or constant flow without involving any modification of apparatus
- Ideal replacement for perfusion system with hydrostatic pressure generation, low perfusate volume in use, perfusion pressure up to 300 mmHg possible
- Can be equipped with oxygenator for optimal aeration of perfusate containing albumin or erythrocytes

The UP-100 is a multi purpose perfusion system best utilized when different types of organs must be perfused either in situ or ex vivo. The modular design of this system allows easy adaptation to different applications using additions or extensions to the base unit.

Applications for in situ perfusion of

hind limb, hindquarter mesenteric bed, liver, kidney:

- Blood vessel tone in peripheral vascular bed
- Balance tests by muscle work (glucose / lactate / pyruvate, high energy phosphates / orthophosphate, etc.)
- Test of vasodilative drugs in occlusive diseases of legs
- Test of muscle relaxants (end-plate pharmacology)

Applications for ex-vivo perfusion using a moist chamber of liver, kidney, mesenteric bed:

- Test of vasodilative drugs
- Studying metabolic processes
- Neural vascular tone
- Organ preservation for transplant

Applications for perfusion of isolated mouse, rat, guinea-pig or very small rabbit heart

Perfusion according to Langendorff. Constant flow or constant pressure perfusion are available using the same equipment. (See pg. K5)

- If isolated heart is only used occasionally and basic parameters are needed
- For student lab

If only perfusion ex-vivo using moist chamber is required, we recommend the use of the PS-1 System, see page K8.

System Extensions for Perfusion in Vitro

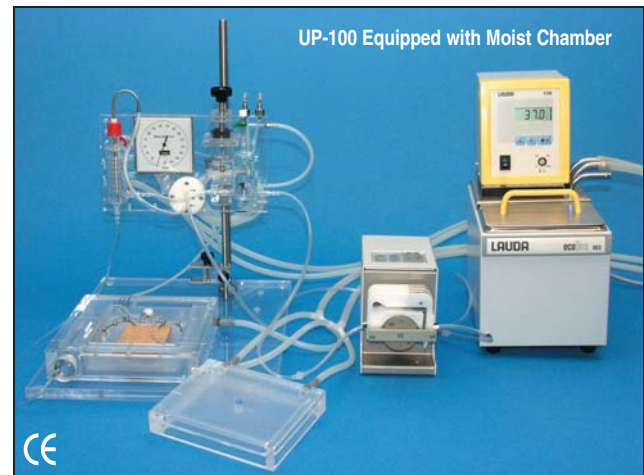

Internal organs (kidney, liver, mesenteric bed) must obviously be kept under optimal physiological conditions, moist and at defined temperature during perfusion. This requires a suitable chamber with the necessary tubing connections for cannulating the organ. Chamber and cover of the moist chamber are both jacketed and are thermostated by passing warm water through them. The interior of the chamber measures 105 x 65 x 16 mm. Using a spacer ring the clear height of the interior can be increased to 34 mm. At the bottom of the interior is a removable cork plate; this is used to carry the tissue which is secured with needles inserted in the cork. Several tubes and apertures in the chamber wall are used for cannulating the tissue and for connecting any measuring instruments required (pressure, flow, electrochemical parameters, etc.). The interior has threaded holes at the sides for fixing mini ball clamps (option) (e.g., for supporting connecting cannulae).

System Extensions for Perfusion in Situ

For perfusion in situ of organs such as liver, kidney, or for perfusion of regional vascular systems like hindquarter, an operating table can be placed on the main Plexiglas plate below the UP-100 mounting platform. Therefore the connection line between organ and heat exchanger can be maintained short to reduce the cooling down of the perfusate.

System Extensions for Perfusion of mouse, rat, guinea-pig or very small rabbit heart

For the perfusion of the isolated heart according to Langendorff, the universal perfusion system UP-100 can be equipped with a jacketed heart chamber and the additional measurement system for isovolumetric IVP using a latex balloon with spindle syringe for diastolic pressure adjustment. The setup represents a compact unit. It can be used for constant pressure or constant flow perfusion of isolated hearts of mice, guinea pigs, rats and small rabbits as long as the coronary flow is below 100 ml/min. The heart is connected via the aortic cannula to the heat exchanger which acts also as bubble trap. The equipment for measurement of coronary flow or for electrogram can also be adapted. If perfusate containing albumin or erythrocytes is used, the oxygenation can be optimized with the additional oxygenator.

Universal Perfusion Tissue Bath Systems

Universal Servo Controlled Perfusion System



- Perfusion possible with very small perfusate quantity
- Accurate control of perfusion pressure or flow
- Compact arrangement of perfusion circuit
- Flexible perfusion circuit setup adjusts to suit individual perfusion conditions

The Universal Servo Controlled Perfusion System is used for the perfusion of organs and tissues using a peristaltic pump. It is a conventional PID controller which operates to maintain either a constant perfusion pressure or a constant perfusion flow.

The following additional items are required to complete the system:

- Measuring system, either for perfusion pressure or for perfusion flow
- Analog pump capable of external control and providing the appropriate pumping rate

The pressure or flow measuring system evaluates the perfusion pressure or perfusion flow (= actual value). This value is fed in to the "actual value" analog input of the SCP PLUGSYS module. The SCP has a provision for setting the required perfusion pressure or perfusion flow which represents the setpoint. From the actual value and the setpoint value, the SCP module produces a control voltage for the pump so that the required perfusion pressure or perfusion flow is produced.

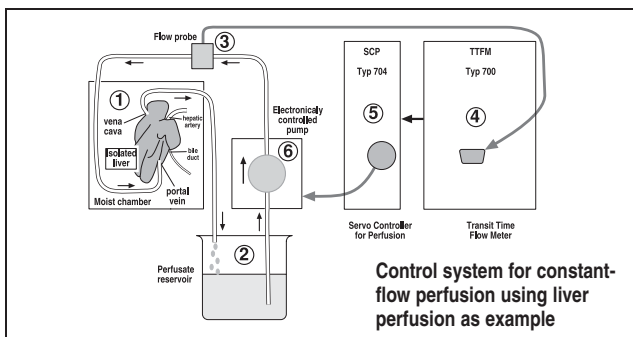
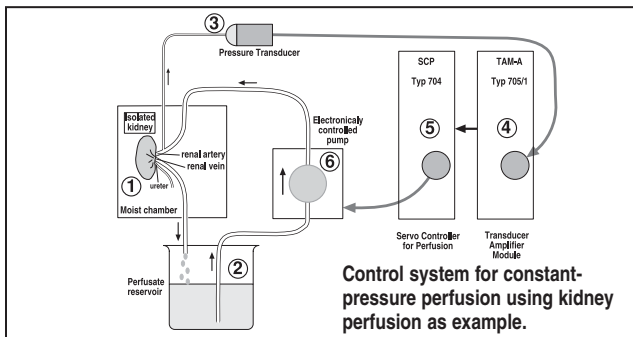

Schuler Tissue Bath System



- 4-channel tissue bath
- 5, 10, 20 and 50 ml tissue vessels available
- Multiple choice of tissue holder to adapt to any application
- Applications:
 - Smooth muscles
 - Heart muscles
 - Skeletal muscles
 - Rings, strips
- Software for Data Acquisition and Control

The Schuler tissue bath system is our most advanced and feature rich tissue bath system used for the study of force or displacement from a wide variety of tissue preparations such as: atria, papillary muscle (without potential recording), and skeletal and smooth muscle (intestine, bladder, uterus).

Isolated intact blood vessels and nerve-muscle preparation experiments are also possible but require the use of special holders. The rigid construction and ergonomic design of the Schuler Organ Bath allows for rapid tissue mounting and adjustment to minimize tissue drying and hypoxia. Tissue bath volumes of 5, 10, 20 and 50 ml are available along with bath and tissue specific holders. Tissue supports are available for rings, strips and specialty applications, with or without platinum plate field stimulation electrodes and include an integrated oxygenating frit at the back of the holder to minimize disruption of force and displacement due to bath oxygenation. A selection of force and displacement transducers is available which are mounted to Vernier positioners.

The HSE-DAQ Software Package ACAD, see page K31, is used to record and export force and displacement measurements. Optional software and hardware modules are available for computer controlled field stimulation, tissue pretension using electronically controlled Vernier positioners and tissue bath flushing.

Systems are available as individual components or complete Turn-key solutions. Accessories include, tissue preparation dishes, buffer reservoirs, wide range of tissue supports, transducers (force and displacement) amplifiers, multi-channel stand alone or programmable stimulators, thermocirculator and all required tubing and connectors.

Graz Tissue Bath System



- Designed for vascular rings but suitable for most standard pharmacological experiments
- Permits experiments both on smooth muscle, cardiac (atria), or skeletal muscles preparations
- Clear, 4-channel arrangement
- Rigid construction
- Contractions can be measured isometrically or isotonicly
- Interchangeable tissue vessels: 2, 5, 10 or 20 ml
- Experiments with minimum test substance quantities are possible using small tissue vessels
- Adaptable to different tissue preparations by suitable form of tissue supports
- Tissue holders with integral field stimulating electrode available
- Simple to operate, easy to clean

The Graz Organ Bath can be used for many standard pharmacological experiments. This apparatus was developed for experiments on small isolated vascular rings (1 to 2 mm dia.) with special attention to a low incubation volume of the medium. The smallest tissue vessel available has a volume of 2 ml. The muscle contractions produced in these experiments can be measured either as forces (isometrically) or as displacements (isotonicly).

The organ bath is also available in variable versions. Larger tissue vessels of 5, 10 or 20 ml are available for larger vessels and other muscle preparations. These baths can also be used for experiments on papillary muscle or isolated atria (e.g. guinea-pig), with provision for electrical stimulation.

The F-30 isometric transducer that we recommend (See page I4) can easily be replaced by different transducers without any modification of the apparatus.

The main consideration in designing the bath has been a simple and clear arrangement, without neglecting the necessary stability. A rigid construction is an essential requirement for measuring small contraction forces. A rigid Plexiglas baseplate carries 4 vertical rods on which the individual components are mounted. Tissue vessels and suitable holders are available in 4 different sizes. The perfusion solution is aerated by glass frits fused into the vessel bottom. A needle valves is provided for each tissue vessel to permit accurate adjustment of the gas flow.

Mayflower Tissue Bath System

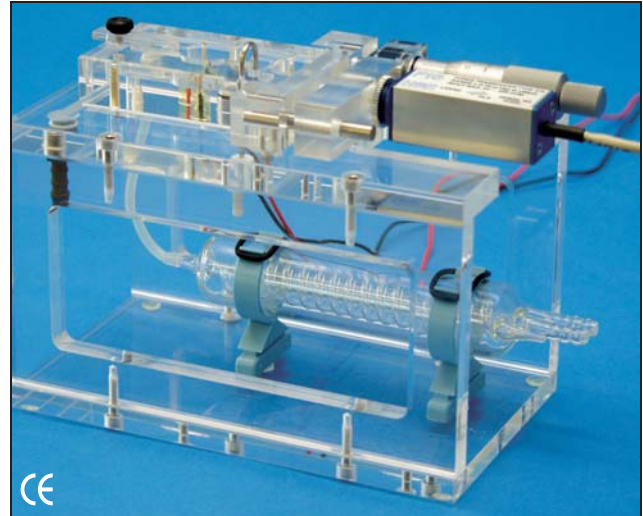

- Horizontal tissue bath for contraction measurements using a force transducer
- Can be used as a flow-through or closed-loop system
- Possibility of electrical stimulation
- Exchangeable holders depending on tissue used (for vascular or tracheal rings, for strips)

The Mayflower tissue bath is a horizontal tissue chamber with an integral contraction force measurement. It is completely open at the top and has a small bath volume of 3 - 5 ml. The compact and modular construction provides ideal conditions for investigations on small muscle preparations (urethra, papillary muscle, cavernous body), vascular rings, or tracheal rings.

The basic equipment consists of:

- Acrylate support with a movable mounting platform for pre-load adjustment through a micrometer screw. This platform acts as holder for the force transducer HSE-HA F-30 or F-10, see page I4. The acrylate support also includes a glass heat exchanger for the pre-heating of the perfusate solution.
- The tissue chamber carved out of a rectangular acrylate block and placed on the support stand. This chamber normally includes the tissue holder, the connections for electrical stimulation electrodes, a frit for aeration and a draw-off tube with height adjustment to set the bath volume.
- A multi-channel roller pump for the perfusate circuit permits operation as recirculating or as flow-through system.
- A thermocirculator for keeping the perfusate solution at constant temperature.

The modular concept of this apparatus offers a wide range of different arrangements to meet individual requirements regarding bath geometry, tissue holders and stimulation electrodes. The horizontal arrangement of the tissue and the open top provide ideal conditions during preparation and experiment. The tissue bath is available as a complete set-up for 1 up to 8 channels. Two connection sockets for the stimulation electrodes are located on either side of the tissue chamber. Different types of electrodes are available. The solution flows in from a roller pump, the outflow is under suction by the same pump.

Tissue Bath Systems

Steiert Tissue Bath System

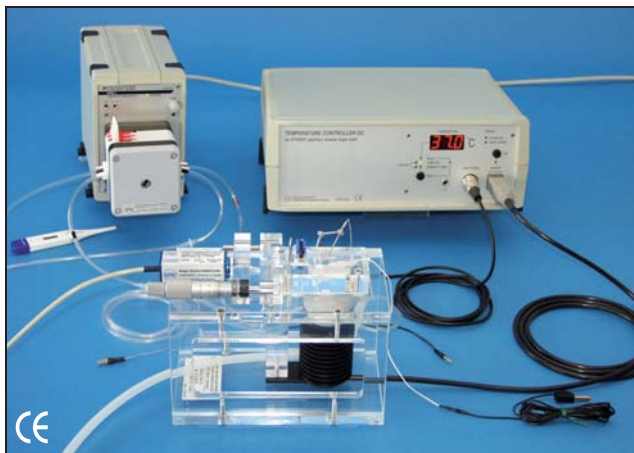

- Compact and easy to use setup for electrophysiology studies on heart muscle
- Suitable for papillary muscle and Purkinje Fibre
- Recording of intracellular action potential and force development
- Mini coaxial electrode for electrical stimulation

The Steiert Tissue bath system is a horizontal system specifically designed for studies of cardiac tissue preparations such as papillary muscle and Purkinje fibers. The unique design allows the user to record both intracellular action potentials and contractile force from the same tissue preparation. Set-ups are available as the core system only or complete Turn-key solutions. The core system includes the tissue bath, pump and DC controlled perfusate warming. The tissue bath has ports for fluid inlet and outlet (adjustable height sipper tube), isometric force transducer mounting with micrometer control to maintain and monitor tissue tension and a direct contact coaxial stimulation electrode. Silicone grease is used to seal the opening through which the tissue support extends from the tissue preparation to the force transducer.

The low volume bath design features an adjustable height sipper tube to adjust and set the bath volume. Other available accessories include amplifiers (bridge amp transducer and Microelectrode Amplifier with matching headstage amplifier), recording electrodes, tissue preparation dish, anti-vibration tables, microscopes, micro-manipulators and many other options. The Microelectrode Amplifier Module includes a separate headstage amplifier used to record intracellular potentials. The headstage amp is easily mounted on a micro-manipulator and the open bath design facilitates electrode placement.

Coleman Superfusion Bath



- Applications:
 - Evaluation of the potency of labile substances
 - Determining the rates of onset and offset of drug action
 - Evaluation of spasmogenic and spasmolytic agents
- Compact, allows the study of up to four tissue preparations in parallel
- Rapid removal of potentially toxic metabolites
- Obviates the necessity of repeated washing procedures
- Rates of onset and offset of drug action are easily measured

In the Coleman Superfusion Bath, the tissue is located in a horizontally split chamber. The lower part of the chamber can be swung away to simplify access to the preparation. The lower end of the tissue is held by a stainless steel hook. The thread attached to the top of the tissue passes through an opening at the top of the chamber for direct to the force transducer. The superfusion solution is fed by a multi-channel roller pump through a stainless steel cannula to the thread and it runs down the thread and superfuses the tissue. Two separate solution paths are available for superfusion with and without test substance. Two platinum wires are placed parallel to the tissue to form the stimulation field. The solution running down provides electrical contact between the electrodes and the tissue. The superfusion vessels are made from an acrylate block and do not require thermostating owing to the low thermal conductivity of the material used.

The superfusion chambers are mounted on a horizontal support rod according to the number of channels required. A stand for 4-position superfusion system is available. The superfusate is thermostated immediately before entering the chamber by a two line heat exchanger supplied from a water thermostat. The heat exchanger is made of a tubing coil that can be easily replaced. A collecting trough is located underneath the superfusion chambers for collecting of the used solution; alternatively the superfusate can be collected from the chamber outlet for recirculation.

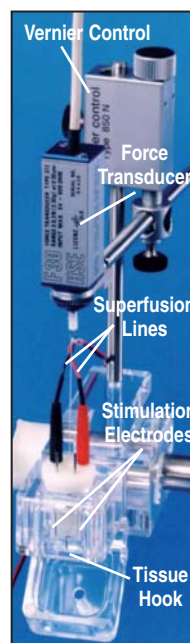

The Superfusion Cascade Bath

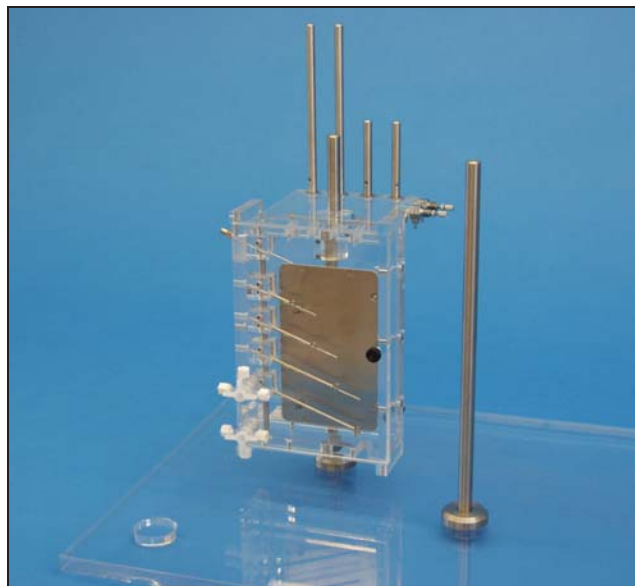

- Applications:
 - Evaluation of metabolites or mediators released on subsequent tissues in the fluid cascade
 - Detection of substances affecting the smooth musculature (prostaglandins, bradykinin, angiotension II...)
- Suitable for colon, bladder, ileum, duodenum, aortic strips...
- Low volume superfusion is useful when only small quantities of drugs are available
- No contact with glass, surface-active substances cannot be absorbed on the glass surface and contaminate results

The Superfusion Cascade Bath permits testing of extremely small quantities of pharmaceuticals. Any metabolites or mediators released are passed to the subsequent test preparation and can become effective there. It is possible to test up to four preparations (muscle strips or isolated tissues). The preparations are contained in a thermostated chamber. A roller pump produces a small flow of solution (1 - 10 ml/min) which is warmed by a heat exchanger then drips on to the uppermost test preparation. There is a provision for switching between two different solutions. The effluve of each preparation passes in the form of a cascade onto the subsequent preparation. Any muscle contractions produced are measured by force transducers (isometric contraction measurement) or displacement transducers (isotonic contraction measurement).

The Superfusion Cascade Bath, as modified by SCHULER, consists of a moist acrylate chamber which is thermostated by radiant heat from a thermostated metal plate. Temperature control is provided by a thermostatic circulator. The four tissues are arranged in cascade so that each tissue receives its superfusion solution from the previous tissue through a small tube. These stainless steel tubes carry a ring to which the tissues are attached. Part of the tube is in the form of an open channel. The tubes can be moved in height (vertically) and also horizontally, ensuring optimum adjustment to suit the suspended tissues and allows superfusion free from any interruption. Mounting the tissues is simplified by the removable front panel of the chamber.

HSE-HA Marsh Ganglion Bath

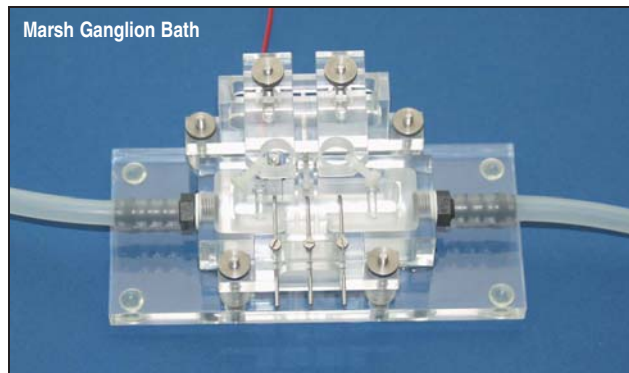

- For studying:
 - Synaptic transmission
 - Nerve conduction
- Applications include:
 - Vagus nerve
 - Cervical ganglion

The HSE-HA Marsh Ganglion Bath is intended to test the action of drugs on the synaptic transmission or nerve conduction in the vagus nerve or the cervical ganglion. The bath is an open-top Perspex bath which is divided into three chambers by

two sliding separators. Each of these separators consists of a lower and an upper part with a cutout to allow the nerve to pass through. The chambers are sealed against each other with Silicone paste. The first chamber contains two platinum electrodes for stimulation. In the second chamber the solution is fed in close to the bottom of the chamber and drawn off at the surface. The Marsh Ganglion Bath includes the necessary components to produce two plastic recording electrodes to interconnect the recording chamber and electrode with the PHDA headstage amplifier. The prepared electrodes can be used for up to two weeks (with proper storage) to record extracellular potentials from the nerve preparation.

In addition a stimulator, electronic equipment and an amplifier with high-impedance input and a peak height detector (PLUGSYS module PHDA) is required

Typical Setup of Marsh Ganglion Bath

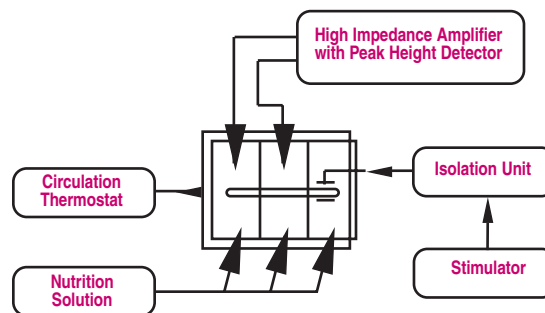

For Stimulators, see Section I of this Catalog.

Universal Perfusion Solution Monitor (pO₂, pCO₂, pH)

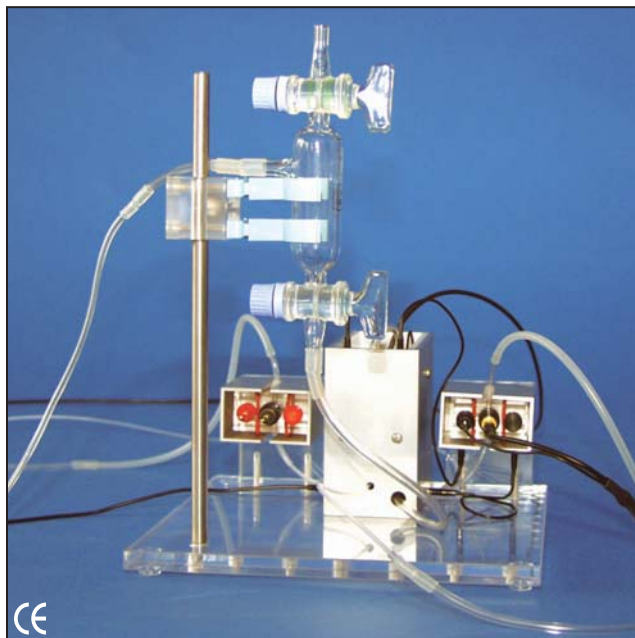

CE

- Compact arrangement, ready to use
- Monitors key parameters in perfusate:
 - pO₂
 - pCO₂
 - pH
- Flow-trough sensors

For studies involving isolated or in situ perfused organs (heart, lung, liver, kidney) it is often important to continuously monitor pO₂, pCO₂ and/or pH of the perfusate. Which parameter is measured depends on the organ used and on the type of experiment conducted.

The universal perfusion solution monitor permits precise continuous or discontinuous measurement in liquid media of these three key parameters pO₂, pCO₂ and pH. The electrodes are all side stream flow-through electrodes and require a pulsation-free roller pump to deliver constant flow of perfusate through the electrode at flow rates in the range from 0.5 to 2 ml/min. The solution is split in parallel and pulled through each of the electrodes simultaneously. Therefore the total minute volume is a function of the flow rate and the number of electrodes used.

The pH sensor requires an external reference electrode (both the pO₂ and pCO₂ contain internal reference electrodes). For pH measurements one of two external reference electrodes are available; either the solid state leak free reference system or a KCl bridge (wet cell) reference system. The solid state leak free reference system is used whenever the perfusate must be recirculated or is required for further analysis. For applications using perfusate containing proteins like albumin it may be necessary to use the KCl bridge reference system for long term signal stability. Because of the high impedance of these sensors, screening or shielding of the measuring circuit is required to guard against electrostatic discharges and other electrical disturbances. The shielding cases also provide a convenient point of attachment to the multi-electrode mounting plate. The electrical signal produced by the electrodes is amplified by one of three PLUGSYS modules OPPM, pHMM or EMM for the O₂, pH and CO₂ electrodes respectively. See pages I46 and I47.

Force Calibration Weights



These NEWTON style calibration weights are precision weights use to calibrate force transducers. The weights are made from polished brass and have an integral hook. They are supplied in a wooden storage case. They are calibrated in Newtons at the standard acceleration of gravity $g_n = 9.80665 \text{ m/s}^2$. Nine weights are supplied. Class of accuracy M1.

Specifications

Newtons	Gram-Force	Newtons	Gram-Force
0.01 N	1	0.2 N	20
0.02 N (2 supplied)	2	0.5 N	50
0.05 N	5	1.0 N	100
0.1 N (2 supplied)	10		

Catalog No.	\$	Product
BS4 73-2634		Force Calibration Weights

Gram Calibration Weights



These gram calibration weights are precision weights use to calibrate preload on force transducers. The weights are made from polished brass. They are supplied in a wooden storage case with a pair of handling forceps and a cleaning brush. Nine weights are supplied. The 0.1, 0.2 and 0.5 gram size weights are flat metal pieces. The larger size weights have an integral hook. Class of accuracy M1 after OIML*.

Specifications

Weight	Tolerance ± mg	Weight	Tolerance ± mg
0.1 g	0.5 mg	2 g (2 supplied)	1.2 mg
0.2 g (2 supplied)	0.6 mg	5 g	1.5 mg
0.5 g	0.8 mg	10 g	2.0 mg
1 g	1.0 mg		

Catalog No.	\$	Product
BS4 73-2635		Gram Calibration Weights

*Note: Organisation Internationale Metrologie Légale

Glass Reservoirs

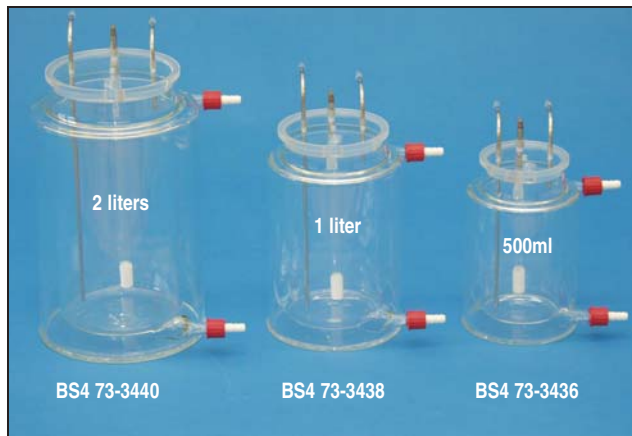

These Glass Reservoirs are for use with a pump. They are heated by a water thermocirculator. To connect to the thermocirculator 5mm ID tubing is necessary. For aeration of perfusate a large gas frit is included. The pump is connected to the left stainless steel suction tube via a LUER connector and tubing. A return flow can be connected to the right (short) stainless steel tube via a LUER connector. Pictured tubing connections are included with each reservoir. Tubing sets must be purchased separately. See below.

Catalog No.	\$	Product
BS4 73-3440		2 Liter Reservoir Jacketed for Buffer Solution with Frit, with connections for outlet of perfusate, inlet for reperfusion and aeration with frit
BS4 73-3438		1 Liter Reservoir Jacketed for Buffer Solution with Frit, with connections for outlet of perfusate, inlet for reperfusion and aeration with frit
BS4 73-3436		0.5 Liter Reservoir Jacketed for Buffer Solution with Frit, with connections for outlet of perfusate, inlet for reperfusion and aeration with frit

Tubing Sets



Catalog No.	\$	Product
BS4 73-3455		Tube Set for Jacketed Buffer Reservoir consisting of: 2 T-pieces, 3m Silicone tubing 9/6mm OD/ID for the thermostating circuit; 3m Tygon tubing 3.2/4.8 mm OD/ID for buffer supply; 1.5m Silicone tubing for aeration supply; 3 male Luer fitting for 3.0mm tubing
BS4 73-3456		Tube Set for Jacketed Buffer Reservoir with Fluid Line Shutoff Valves consisting of: 2 T-pieces, 3m Silicone tubing 9/6 mm OD/ID, 2 shutoff inline coupling for the thermostating circuit; 3m Tygon tubing 3.2/4.8 mm OD/ID or buffer supply; 1.5m Silicone tubing for aeration supply; 3 male Luer fitting for 3.0mm tubing

Reservoirs with Bottom Drain

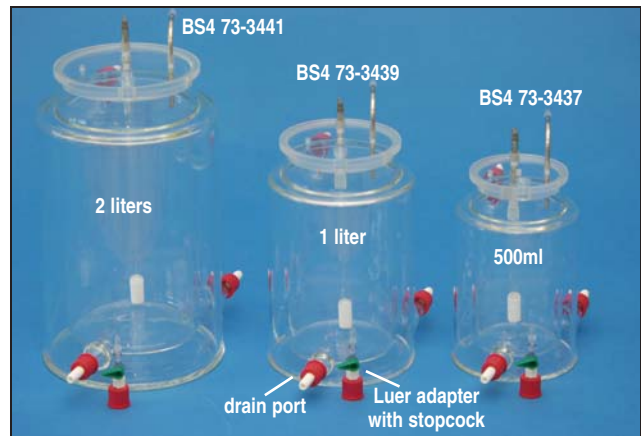

These Glass Reservoirs have a bottom drain. They are for gravity supply systems or for use with a pump. The Reservoirs are heated by a water thermocirculator. For aeration of perfusate they are supplied with a large gas frit. The outlet is the drain port at the bottom. It can be directly connected to a 5mm ID tubing or via a LUER adapter to the stopcock. A return flow can be connected to the right (short) stainless steel tube via a LUER connector. Pictured tubing connections are included with each reservoir. Tubing sets must be purchased separately.

Catalog No.	\$	Product
BS4 73-3441		2 Liter Reservoir Jacketed for Buffer Solution with Frit and Bottom Drain, with connections for outlet of perfusate, inlet for reperfusion and aeration with frit, designed for gravity supply
BS4 73-3439		1 Liter Reservoir Jacketed for Buffer Solution with Frit and Bottom Drain, with connections for outlet of perfusate, inlet for reperfusion and aeration with frit, designed for gravity supply
BS4 73-3437		0.5 Liter Reservoir Jacketed for Buffer Solution with Frit and Bottom Drain, with connections for outlet of perfusate, inlet for reperfusion and aeration with frit, designed for gravity supply
BS4 73-3566		Repl. Frit for 2.0 Liter Glass Reservoirs Reservoirs and Reservoirs with Bottom Drain
BS4 73-3565		Repl. Frit for 1.0 Liter Glass Reservoirs Reservoirs and Reservoirs with Bottom Drain
BS4 73-3564		Repl. Frit for 0.5 Liter Glass Reservoirs and Reservoirs with Bottom Drain
BS4 73-3562		Fluid Outlet with Stopcock for Jacket Reservoir with Bottom Drain

Oxygenators

Fiber (Membrane) Oxygenator



- Hollow Fiber Oxygenator
- Hemophan® Membrane Material
- 18 ml Total Priming Volume
- 0.22 m² Active Oxygenating Surface Area
- Can Be Used 3 to 10 Times
- Available in individual units (Catalog Number: BS4 73-0103)
- Available in packages of 5 (Catalog Number: BS4 73-0104)

Alternative oxygenator to glass frit oxygenating bubblers or glass bulb oxygenators. The membrane oxygenator is used for blood, blood doped perfusate, or when using perfusate that contains protein to prevent foaming.

Specifications

Membrane:	
Material	Hemophan®
Effective Surface Area	0.22 m ²
Wall thickness	6.5 µm
ID	200 µm
Effective Fiber Length	185 mm
Sterilization	Gamma Irradiation
Priming Volume	18 ml
Oxygenator Materials:	
Housing	Acrylonitrile-Butadiene-Styrene (ABS)
Bloodports	Polycarbonate
Potting	Polyurethane
Spacer Filaments	Polyester
Oxygenator:	
Maximum Recommended TMP	500 mmHg
Dimensions	215 x 35 mm
Weight (grams)	ca. 62

Catalog No.	\$	Product
BS4 73-0103		Fiber (Membrane) Oxygenator, pkg. of 1
BS4 73-0104		Fiber (Membrane) Oxygenator, pkg. of 5
BS4 73-3056		Mounting Kit ¹
BS4 73-2945		Gas & Perfusate Connector Set

¹ -Oxygenator mounting kits also require a system specific Oxygenator Holder except when used with the PS-1 system. The different holders available are listed in Table listed to the right.

Oxygenator Holders



Oxygenator Holder for UP100 or IH-SR System (A)

- Holds Fiber Oxygenator (BS4 73-0103 / BS4 73-0104)
- Holds Glass Bulb Oxygenator (BS4 59-7930)
- 13 mm OD Maximum for Mounting Rod (rod not included)

Oxygenator Holder for UP100D System (B)

- Holds Fiber Oxygenator (BS4 73-0103 / BS4 73-0104)
- Holds Glass Bulb Oxygenator (BS4 59-7930)
- Includes 1 Needle Valve for gas regulation
- 20 mm OD Maximum for Mounting Rod (rod not included)

Stand Alone Oxygenator Holder (C)

- Holds Fiber Oxygenator (BS4 73-0103 / BS4 73-0104)
- Holds Glass Bulb Oxygenator (BS4 59-7930)
- Includes 1 Needle Valve for gas regulation
- 13 mm OD Maximum for Mounting Rod (rod not included)

Oxygenator Holders

Holder for:	Catalog No.	# of Needle Valves Included	Maximum Diameter for Rod Mount
(A) UP100 & IH-SR \$	BS4 73-3061	0	13 mm
(B) UP100D \$	BS4 73-3057	1	20 mm
(C) Stand Alone \$	BS4 73-3058	1	13 mm

Kit for Mounting an Oxygenator to any Oxygenator Holder

- 2 Ring Clamps to Hold Oxygenator
- Tubing Adapters for Oxygenator
- Silicone & Tygon Tubing

Catalog No.	\$	Product
BS4 73-3056		Kit for Mounting Fiber Oxygenator to any Oxygenator Holder
BS4 73-3063		Kit for Mounting Glass Bulb Oxygenator to any Oxygenator Holder

Latex Ballons for Isovolumetric Contractile Force



Latex Balloons are used for measuring isovolumetric contractile forces in the left ventricle of isolated perfused hearts. These latex balloons are available in several different sizes to be used with hearts from rats up to pigs. Review the table to select the right size balloon for your application. These latex balloons are not suitable for mice hearts due to the rigidity of the latex material. A technique using cling-film allows you to create small balloons which can be used for such small hearts. If you are working with mice, please order the Mouse Ventricular Balloon Kit BS4 73-2787. These Latex Balloons are sold in packages of 10 balloons. There are also convenient sample kits available that contain a selection of various sized balloons. Stainless steel catheters and Syringes are also available, see right column.

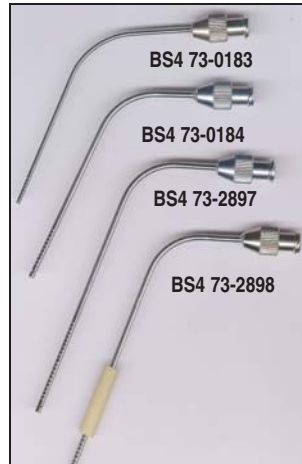

Mouse Ventricular Balloon Kit



- Simple Means to Produce Balloons for LVP Measurement in Isolated Mice Heart
- Easy to use

Latex Balloons are traditionally used for measuring isovolumetric contrac-

tile forces in the left ventricle of isolated perfused hearts. Latex balloons are not suitable for mice hearts due to the rigidity of the latex material. A technique using cling-film allows you to create small balloons which can be used for such small hearts. All the components to make these balloons are included in a convenient kit.

This kit for Mouse Ventricular Balloons includes the tools and procedure to assemble balloons for isovolumetric left ventricular pressure measurement in the isolated perfused mouse heart. The kit consists of a stand with two holders and crocodile clamps, hex screwdriver modified for balloon forming, syringe, scissor, cling wrap and PE tubing.

Table for Selecting Balloon Size*

Species	Body Weight (kg)	Size No.	Latex Balloons, pkg. 10		
			Volume**	Sizes: D x L mm	Catalog No.
Mouse & Small Rat	0.02 to 0.1	Mouse Ventricular Balloons see BS4 73-2787 Kit on K21			No Balloon Available
Rat	0.1 to 0.2	3	0.03 ml	3 x 7	BS4 73-3478
Guinea Pig	0.3 to 0.4	4	0.06 ml	4 x 8	BS4 73-3479
		5	0.1 ml	5 x 9	BS4 73-3480
		6	0.2 ml	6 x 10	BS4 73-3481
Rabbit	1.0	7	0.3 ml	7 x 11	BS4 73-3482
		8	0.4 ml	8 x 12	BS4 73-3483
		9	0.5 ml	9 x 13	BS4 73-3484
Cat	1.7	10	0.7 ml	10 x 14	BS4 73-3485
		12	1.3 ml	12 x 17	BS4 73-3486
		13	1.6 ml	13 x 18	BS4 73-3487
		14	1.9 ml	14 x 19	BS4 73-3488
		15	2.4 ml	15 x 20	BS4 73-3489
		16	3.0 ml	16 x 22	BS4 73-3490
Dog	3.5 to 4.0	17	3.5 ml	17.2 x 23	BS4 73-3491
		18	4.0 ml	18 x 24	BS4 73-3492
		19	5.0 ml	19 x 25	BS4 73-3493
		24	10 ml	24 x 32	BS4 73-3494
		30	20 ml	30 x 40	BS4 73-3495

* Balloon Sample Kits are available, see below.

** Volume unloaded.

Catalog No.	\$	Product
BS4 73-2787		Mouse Ventricular Balloon Assembly Kit
BS4 73-0183		Stainless Steel Catheter 1464 LL2 (0.01 kg) for Balloon Size 3 or 4
BS4 73-0184		Stainless Steel Catheter 1464 LL3 (0.01 kg) for Balloon Size 5 to 10
BS4 73-2897		Stainless Steel Catheter 1464 LL4 (0.01 kg), for Balloon Size 12 to 18
BS4 73-2898		Stainless Steel Catheter 1464 LL5 (0.01 kg), for Balloon Size 19 to 30
BS4 72-1863		1 cc Threaded Syringe
BS4 72-1864		2.5 cc Threaded Syringe
BS4 73-3341		Balloon Sample Kit, 2 each of Sizes 3 through 10, pkg. 16 Balloons
BS4 73-3342		Rat/Guinea Pig Balloon Sample Kit, 5 each of Sizes 3 through 6, pkg. 20 Balloons
BS4 73-3343		Rabbit Balloon Sample Kit, 5 each of Sizes 7 through 10, pkg. 20 Balloons
BS4 73-0143		Mini Balloon Kit for Mouse Heart, see page K20
BS4 73-0331		Universal Mini Balloon Kit for LVP on Isolated Mouse Hearts
BS4 73-3560		Universal Balloon Kit for Rat/Guinea Pig Heart
BS4 73-2813		Balloon Kit for Rat / Guinea Pig Hearts to IH-SR
BS4 73-0197		Balloon Kit for Rat / Guinea Pig Hearts
BS4 73-0323		Balloon Kit for Rabbit Hearts
BS4 73-0327		Balloon Kit for Pig Hearts
BS4 73-0329		Balloon Kit for Small Pig Hearts

LVP Balloon Kits

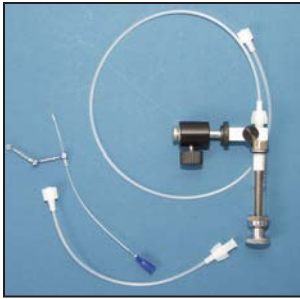

IH-SR Mini Balloon Kit for Mice Hearts

This kit includes 10 PE catheters for connecting the balloon to the pressure transducer, Luer stub cannula OD 0.6mm, holder with ball joints for fixation of the balloon in the left ventricle, spindle syringe for sensitive filling of balloons.

Catalog No.	\$	Product
BS4 73-0143		IH-SR Mini Balloon Kit for Mice Heart



IH-SR Balloon Kit For Rat/Guinea Pig Hearts

This kit includes ball-joint holder, steel catheter 1464 LL2-IHSR, 10 balloons No. 5 (0.1 ml), spindle syringe for sensitive filling of balloons to adjust preload (balloon pressure), blunt Luer cannula, holder with ball joints for spindle syringe.

Catalog No.	\$	Product
BS4 73-2813		Balloon Kit for Rat / Guinea Pig Hearts to IH-SR



J-Holder LVP Kit for IH-SR in Working Heart Mode

This special holder was designed to maintain the small PE-catheter forced through the left ventricle apex for LVP measurement in the isolated working mouse heart. In combination with the mini ball joint holders a precise fixation without stress load from the PE-catheter on the heart is possible.

This kit includes a J-holder for PE-catheters, Luer adapter, 2 mini ball joints, 1 ball with thread and 10 PE-catheters l = 15 cm.

Catalog No.	\$	Product
BS4 73-0179		J-Holder for LVP Catheter for Isolated Working Mouse Heart, Including Cannula
BS4 73-0167		LVP Kit for IH-SR WH



Universal Mini Balloon Kit for LVP on Isolated Mice Hearts

This kit includes a PE catheter for connecting the balloon to the pressure transducer, cannula, T-piece, holder for balloon catheter with 2 mini ball joint holders, plexiglass block clamp and bar with ball, and spindle syringe.

Catalog No.	\$	Product
BS4 73-0331		Universal Mini Balloon Kit for LVP on Isolated Mice Hearts

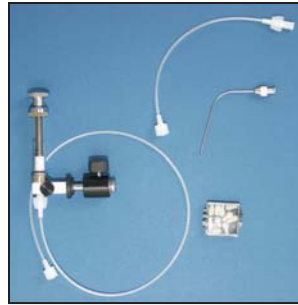

Universal Balloon Kit V.1 For Rat/Guinea Pig Hearts

This kit includes a steel catheter 1464 LL2, 10 balloons No. 4 (0.06 ml), spindle syringe for sensitive filling of balloons to adjust preload (balloon pressure), including holder with ball joints for spindle syringe.

Catalog No.	\$	Product
BS4 73-0197		Universal Balloon Kit V.1 for Rat/Guinea Pig Hearts



Universal Balloon Kit V.2 for Rat/Guinea Pig Hearts

This kit includes a ball-joint holder, LL2-IHSR, 10 balloons No. 5 (0.1 ml), blunt Luer cannula, plexiglass block clamp and bar with ball, spindle syringe with LECTROCATH catheter for sensitive filling of balloons to adjust end diastolic preload (balloon pressure), including holder with ball joints for spindle syringe.

Catalog No.	\$	Product
BS4 73-3560		Universal Balloon Kit V.2 for Rat/Guinea Pig Hearts

Balloon Kit for Rabbit Hearts

This kit includes a steel catheter 1464 LL4, 5 balloons No. 12 and 5 balloons No. 13, spindle syringe for sensitive filling of balloons to adjust preload (balloon pressure), including holder with ball joints.

Catalog No.	\$	Product
BS4 73-0323		Balloon Kit for Rabbit Hearts

Balloon Kit for Pig Hearts

This kit includes a steel catheter 1464 LL5, 10 balloons Nr. 18 (3.5 ml), (BS4 73-0329), or No. 24 (9.6 ml) (BS4 73-0327), spindle syringe for sensitive filling of the balloon to adjust preload (balloon pressure), including holder with ball joints.

Catalog No.	\$	Product
BS4 73-0329		Balloon Kit for Small Pig Hearts
BS4 73-0327		Balloon Kit for Pig Hearts

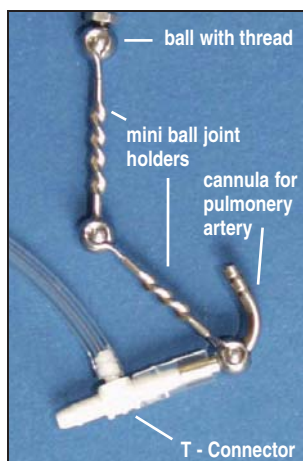

Ball Joint Holder and Cannulating System for Pulmonary Artery

This special holder was designed to cannulate the pulmonary artery on isolated perfused heart. In combination with the mini ball joint holders a precise fixation without stress load from the cannula on the heart and vessel is possible. It is used for collecting the effluente of the heart for measuring gas concentrations or metabolism analysis. It allows also to measure coronary flow

on a working heart by connecting the appropriate flow sensor.

Catalog No.	\$	Product
-------------	----	---------

BS4 73-2934		Ball Joints and Cannulating System for Pulmonary Artery on Rat / Guinea Pig Hearts to IH-SR
-------------	--	---

BS4 73-0206		Universal Ball Joints and Cannulating System for Pulmonary Artery on Rat / Guinea Pig Hearts
-------------	--	--



Aortic Cannulae to IH-SR System

These special cannulae were designed for cannulating isolated heart to mount on the IH-SR System, see page K4.

Catalog No.	\$	Product
-------------	----	---------

BS4 73-2816		Aortic Cannula to IH-SR, OD 1.0 mm
-------------	--	------------------------------------

BS4 73-2857		Aortic Cannula to IH-SR, OD 1.3 mm
-------------	--	------------------------------------

BS4 73-2858		Aortic Cannula to IH-SR, OD 1.5 mm
-------------	--	------------------------------------

BS4 73-2859		Aortic Cannula to IH-SR, OD 1.8 mm
-------------	--	------------------------------------

BS4 73-2860		Aortic Cannula to IH-SR, OD 2.0 mm
-------------	--	------------------------------------

BS4 73-2814		Aortic Cannula to IH-SR, OD 2.3 mm
-------------	--	------------------------------------

BS4 73-2861		Aortic Cannula to IH-SR, OD 2.5 mm
-------------	--	------------------------------------

BS4 73-2862		Aortic Cannula to IH-SR, OD 3.0 mm
-------------	--	------------------------------------

Aortic Cannulae to IH-5 System

These special cannulae were designed for cannulating isolated heart to mount on the IH-5 System, see page K4.

Catalog No.	\$	Product
-------------	----	---------

BS4 73-3065		Aortic Cannula to IH-5, OD 2.0 mm
-------------	--	-----------------------------------

BS4 73-3089		Aortic Cannula to IH-5, OD 2.5 mm
-------------	--	-----------------------------------

BS4 73-2876		Aortic Cannula to IH-5, OD 3.0 mm
-------------	--	-----------------------------------

BS4 73-2877		Aortic Cannula to IH-5, OD 3.5 mm
-------------	--	-----------------------------------

BS4 73-2878		Aortic Cannula to IH-5, OD 4.0 mm
-------------	--	-----------------------------------

BS4 73-2879		Aortic Cannula to IH-5, OD 5.0 mm
-------------	--	-----------------------------------

BS4 73-2880		Aortic Cannula to IH-5, OD 6.0 mm
-------------	--	-----------------------------------



Cannulae for Isolated Liver or Kidney perfusion

These special cannulae were designed for non traumatic cannulation of an isolated perfused liver or kidney. The cannulae are equipped with a basket like tip to avoid any occlusion of the vessel during preparation and experiment. The cannulae are available at different sizes depending on the species and with or without side port for pressure measurement.

The cannulae are also available as cannulating system to the moist chamber and for the PS-1 System, see page K8.

These cannulae can also be combined with Mini Ball Joint Holders to built universal perfusion cannulating systems.

Catalog No.	\$	Product
-------------	----	---------

BS4 73-3308		In Situ Cannula with Basket OD 1.0 mm
-------------	--	---------------------------------------

BS4 73-3310		In Situ Cannula with Basket OD 1.3 mm
-------------	--	---------------------------------------

BS4 73-3312		In Situ Cannula with Basket OD 2.0 mm
-------------	--	---------------------------------------

BS4 73-3314		In Situ Cannula with Basket OD 2.3 mm
-------------	--	---------------------------------------

BS4 73-3309		In Situ Cannula with Basket and Side Port OD 1.0 mm
-------------	--	---

BS4 73-3311		In Situ Cannula with Basket and Side Port OD 1.3 mm
-------------	--	---

BS4 73-3313		In Situ Cannula with Basket and Side Port OD 2.0 mm
-------------	--	---

BS4 73-3315		In Situ Cannula with Basket and Side Port OD 2.3 mm
-------------	--	---

BS4 73-2946		Ex Vivo Cannula with Basket OD 1.0 mm and Holder to Moist Chamber
-------------	--	---

BS4 73-0729		Ex Vivo Cannula with Basket OD 1.3 mm and Holder to Moist Chamber
-------------	--	---

BS4 73-2947		Ex Vivo Cannula with Basket and Side Port OD 1.0 mm and Holder to Moist Chamber
-------------	--	---

BS4 73-2777		Ex Vivo Cannula with Basket and Side Port OD 1.3 mm and Holder to Moist Chamber
-------------	--	---

BS4 73-2778		Ex Vivo Cannula with Basket and Side Port OD 2.3 mm and Holder to Moist Chamber
-------------	--	---

Aortic Cannulae for UP100 Langendorff System

Catalog No.	\$	Product
-------------	----	---------

BS4 73-0112		Set of 4 Aortic Metal Cannula with Luer Taper, 2.0, 2.5, 3.0, and 4.0 mm OD
-------------	--	---

BS4 73-2798		1.0 mm OD Aortic Metal Cannula with Luer Taper
-------------	--	--

BS4 73-2800		1.3 mm OD Aortic Metal Cannula with Luer Taper
-------------	--	--

BS4 73-2867		1.5 mm OD Aortic Metal Cannula with Luer Taper
-------------	--	--

BS4 73-3337		1.8 mm OD Aortic Metal Cannula with Luer Taper
-------------	--	--

BS4 73-2868		2.0 mm OD Aortic Metal Cannula with Luer Taper
-------------	--	--

BS4 73-2869		2.3 mm OD Aortic Metal Cannula with Luer Taper
-------------	--	--

BS4 73-2870		2.5 mm OD Aortic Metal Cannula with Luer Taper
-------------	--	--

BS4 73-2871		3.0 mm OD Aortic Metal Cannula with Luer Taper
-------------	--	--

BS4 73-2872		4.0 mm OD Aortic Metal Cannula with Luer Taper
-------------	--	--

Mini-Coaxial Stimulation Electrode

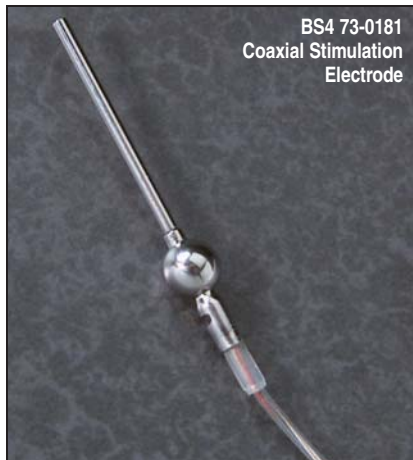

This stimulation electrode is used for electrical stimulation of small heart or tissues. Through the coaxial construction the other electrode at zero potential acts as a screen so that stray fields are reduced and interference to recordings is limited (ECG, MAP). In combination with the mini ball joint holders a precise fixation on the myocard is possible.

Specifications

Outside Diameter	1.3 mm
Length of Cylinder	20 mm
Cable Length	35 mm ending on 4 mm MC Banana Plugs, 2-core screened cable

Catalog No.	\$	Model
BS4 73-0160		Small Stimulation Electrode Set, Includes BS4 73-0181 & BS4 73-0182
BS4 73-0181		Mini Coaxial Stimulation Electrode with modified Lemos connector
BS4 73-0182		Adapter Cable - modified Lemos connector to 4 mm Banana Plugs

Coaxial Stimulation Electrode

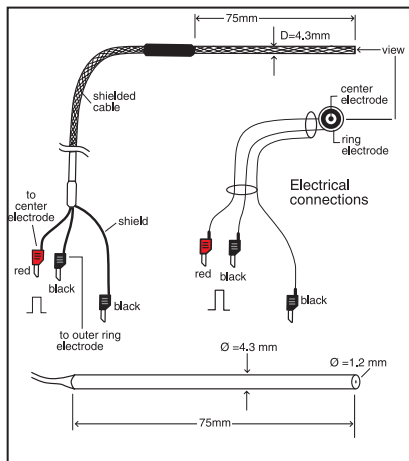

- For electrical stimulation of the isolated perfused heart
- Reduced stray fields for more accurate recordings

This stimulation electrode is used for electrical stimulation of hearts. Through the coaxial construction the other electrode at zero potential acts as a screen so that stray fields are reduced and interference to recordings is limited (ECG, MAP). In combination with the special holder a precise fixation on the myocard is possible. A special holder for easy positioning of the electrode on the heart surface is available as an accessory.

Specifications

Outside Diameter	4.3 mm
Length of Cylinder	75 mm
Cable Length	120 mm ending on 4 mm MC Banana Plugs, 2-core screened cable
Weight	40 g, without holder

Catalog No.	\$	Product
BS4 73-0219		Coaxial Stimulation Electrode
BS4 73-0220		Holder with Ball Joint for Stimulation Electrode

Mini ECG Electrode for Isolated Hearts

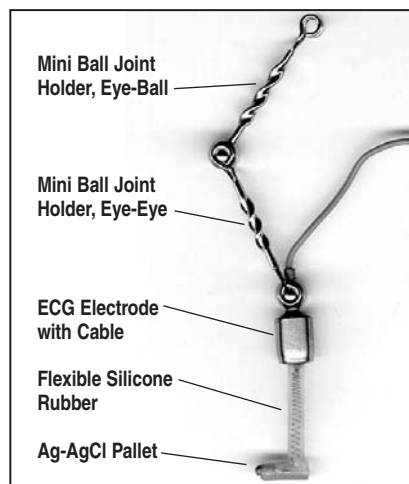

This special Monopolar ECG electrode was designed to get the ECG from the surface of isolated hearts. The electrode can be used from the isolated mice heart up to the pig heart. In combination with the mini ball joint holders a precise fixation on the myocard is possible. Due to the flexible end these electrodes follow the beating heart. Connection: 4 mm banana connector, cable length 1 m.

Note: Two electrodes are necessary for measuring ECG.

Caalog. No.	\$	Model
BS4 73-0200		Monopolar ECG Electrode for Isolated Heart
BS4 73-0148		Cable with Banana Plugs for ECGA or BPA for Small Animals

ECG and MAP Electrodes

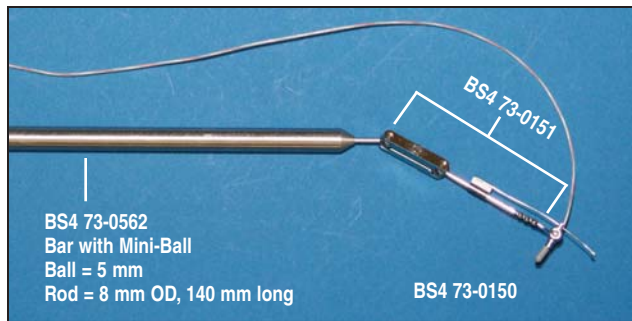

Mini MAP Electrode for Isolated Hearts

This special electrode was designed to get the MAP from the surface of isolated hearts. The technique used is described by Prof. Franz (Washington DC). The electrode can be used from the isolated mice heart up to the rabbit heart. This electrode has a recording electrode at its tip and an integral reference electrode which is side mounted. Both electrodes contact the cardiac surface through contact with tubular MAP sponge (not shown above). In combination with the mini ball joint holders a precise fixation on the myocardium is possible.

Catalog No.	\$	Model
BS4 73-0150		MAP-Tip Electrode, needs a Holder
BS4 73-2910		Sponges for MAP Epicardial Electrodes, pkg. of 12
BS4 73-0152		Connecting Cable for MAP Electrode on BPA
BS4 73-0151		Holder for MAP Electrode for IH-SR System
BS4 73-0556		Stand and Holder with Ball Joints for MAP Electrode

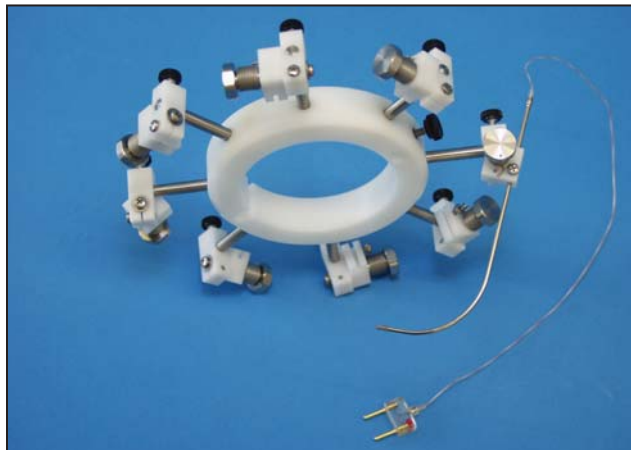

Multiple MAP Electrode Holder

This special Holder for up to 8 MAP-Electrodes has been designed. On this holder are located eight cantilever arms holding spring-loaded MAP-Electrodes. Each electrode can be positioned individually on the heart. The spring force can also be adjusted individually. The holder has all the features to be mounted on the IH-5, see page K4. The electrodes are connected to the input box of the MAPM Plugsys amplifier. The electrodes are purchased separately.

Catalog No.	\$	Model
BS4 73-0551		Circular Holder for 8 MAP-Electrodes to IH-5
BS4 73-0409		MAP Electrode
BS4 73-2910		Sponges for MAP Epicardial Electrodes, pkg. of 12

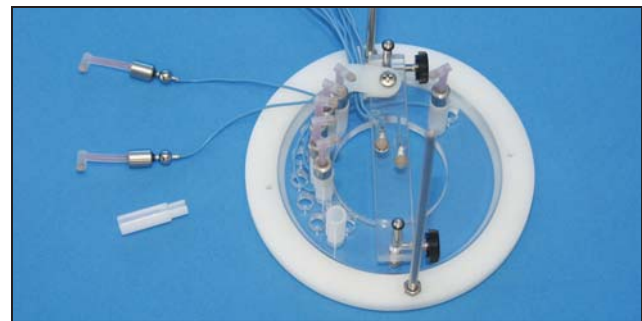

Multi-Lead ECG Recording

Mini ECG electrodes are mounted on an insert. The insert has been designed for multi-lead ECG recording on guinea-pig, rat and rabbit heart, it has all the features to be mounted on the IH-5, see page K4. The electrodes can individually be adjusted to be as near as possible to the heart surface. Depending on the number of electrodes installed it is possible to mimic an "EINTHOVEN" derivation as well as "WILSON" VI-V6 unipolar leads. The electrodes are connected to the input box of the EGM and WLA Plugsys amplifier

Catalog No.	\$	Model
BS4 73-0550		ECG Electrode Insert for 10-Lead ECG
BS4 73-0200		Monopolar ECG Electrode for Isolated Heart

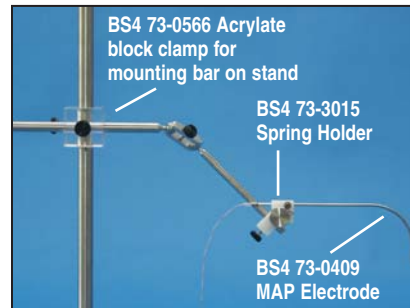

- Supplied with holder for In Situ applications
- Integrated reference electrode

Monophasic Action Potential (MAP) Tip Electrode

This Monophasic Action Potential Electrode is the same electrode as BS4 73-0150 (see above) except it is mounted in a stainless steel tube. It may be used with either the BS4 73-0551 Multiple MAP Recording Holder or the BS4 73-3015 Stand Alone Spring Holder. It requires MAP sponges in order to work properly. These must be purchased separately, BS4 73-2910.

The Spring Holder includes a 6mm diameter rod that measures 100mm in length, BS4 73-0562 Mounting Rod and a BS4 73-0564 Connector. A Mounting clamp must be purchased separately. We recommend the BS4 73-0566 Acrylate Clamp.

Catalog No.	\$	Product
BS4 73-0409		Monophasic Action Potential (MAP) Tip Electrode with Integrated Reference Electrode Mounted in Stainless Steel Tube
BS4 73-2910		Sponges for MAP Recording, pkg. of 12
BS4 73-3015		Spring Holder for BS4 73-0409 MAP Electrode for Lab Stand
BS4 73-3002		Spring Holder for BS4 73-0409 MAP Electrode with 6mm OD Rod, 60mm long for use with Micromanipulator

Tissue Clips and Hooks

Harvard Apparatus Tissue Clips

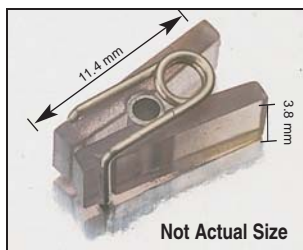

- For suspending biological preparations in tissue vessels
- Rapid sample attachment
- Even clamping pressure
- Lightweight; small size
- Extremely low drug absorption
- Easily cleaned

A pair of these tissue clips provides a quick and simple means of attaching small pieces of biological tissue for suspension in isolated tissue vessels. Preparations such as vascular smooth muscle, papillary muscle, skeletal muscle and intestinal sections are particularly well suited for this type of clip. The clip provides firm uniform pressure across the clamping region by means of a stainless steel spring.

Specifications

Overall Size	3.8 x 11.4 mm (0.150 x 0.450 in)
Clamping Pressure	No slip at 40 g min
Materials:	
Clip	Barex 210, Vistron Corp.
Axle/Spring	Stainless Steel tube
Weight	250 mg

Catalog No. \$ Product

BS4 56-5119 Harvard Apparatus Tissue Clips, pkg. of 2



Harvard Apparatus Heart Clips

These light, spring wire heart clips are used to attach a thread to a frog or mammalian heart. Both clips are made of stainless steel wire and ensure a firm grip.

Harvard Apparatus Heart Clips

Catalog No.	Description	Clip Length	Clip Spread Maximum
BS4 50-5909 \$	Frog Heart Clips	16 mm (0.6 in)	7 mm (1/4 in)
BS4 50-5917 \$	Mammalian Heart Clips	32 mm (1-1/4 in)	10 mm (0.4 in)

Supplied in packages of 5.

Thread Connection Clip

This clip permits simple attachment of the tension thread to the transducers. The special feature of the thread clip is that the length of the thread can easily be adjusted without having to undo or make a knot. This clip provides reliable and secure clamping even with fine threads. The Thread Connection Clip is constructed from stainless steel wire which is 0.5 mm in diameter. The over all length of the clip is 45 mm.



Catalog No. \$ Product

BS4 73-0572 Thread Connection Clip, pkg. of 1

Flat Serrated Hook Clip

This clip has flat serrated stainless steel hook jaws and side loops. The Flat Serrated Hook Clip is constructed from stainless steel wire which is 0.5mm in diameter. The overall length of the clip is 17 mm.

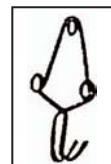

Catalog No. \$ Product

BS4 73-0573 Flat Serrated Hook Clip, pkg. of 1

Pointed Jaw Clip

This clip features pointed jaws and side loops for simple operation. The Pointed Jaw Clip is constructed from stainless steel wire which is 0.5mm in diameter. The overall length of the clip is 14 mm.

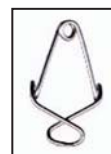

An Extra Fine Pointed Jaw Clip is also available. It is constructed from stainless steel wire which is 0.4mm in diameter. The overall length of the clip is 10 mm.

Catalog No. \$ Product

BS4 73-0574 Pointed Jaw Clip, pkg. of 1

BS4 73-3563 Extra Fine Pointed Jaw Clip, pkg. of 1

Long Flat Jaw Clip

This clip features long flat jaws and side loops for simple operation. The Long Flat Jaw Clip is constructed from stainless steel wire which is 0.5mm in diameter. The overall length of the clip is 18 mm. The jaw size is 0.5 x 5 mm.



Catalog No. \$ Product

BS4 73-0575 Long Flat Jaw Clip, pkg. of 1

Long Jaw Clip

This Long Jaw Clip has longer jaws. The jaw size is 0.7 x 5 mm. The Long Jaw Clip is constructed from stainless steel wire which is 0.5mm in diameter. The overall length of the clip is 18 mm.

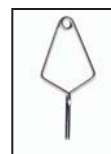

Catalog No. \$ Product

BS4 73-3340 Long Jaw Clip, pkg. of 1

Triangular Hooks

These Triangular Hooks are used to support tissue rings for cylindrical vessel segments and tracheal rings. All 3 sizes are constructed from stainless steel wire which is 0.3mm in diameter.

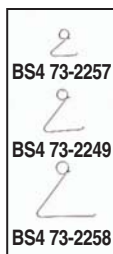
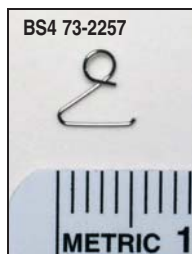

- Three sizes available for tissue rings
- Ideal for cylindrical vessel segments and tracheal rings
- Holder for vessel segments up to 8 mm (0.3 in) in length

Catalog No.	\$	Product
BS4 73-2257		Triangular Hook Size 0, Hook Width 5.0 mm, Height 5.4 mm, Loop Ø 2.0 mm, pkg. of 1
BS4 73-2249		Triangular Hook Size 1, Hook Width 8.0 mm, Height 9.0 mm, Loop Ø 2.5 mm, pkg. of 1
BS4 73-2258		Triangular Hook Size 2, Hook Width 12.0 mm, Height 11.0 mm, Loop Ø 3.0mm, pkg. of 1

Long Loop Clip

The Long Loop Clip is constructed from stainless steel wire which is 0.3 mm in diameter. It is similar to the BS4 73-3340, but is finer in dimensions. The overall length of the clip is 16 mm. The jaw diameter is 2 mm

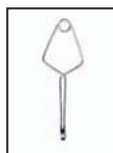

Catalog No.	\$	Product
BS4 73-0577		Long Loop Clip, pkg. of 1

Organ Hook

The Organ Hook Clip has a pointed hook that permits easy mounting of organs. It is constructed from stainless steel wire which is 0.5mm in diameter. The overall length of the hook is 7.5 mm.



Catalog No.	\$	Product
BS4 73-0578		Organ Hook, pkg. of 1

Serre Fine Tip Closing Clip

This Serre Fine Tip Closing Clip features tip closing jaws for securing tissues. It is constructed from stainless steel wire which is 0.5mm in diameter. The jaw measures 3mm. The overall length of the clip is 17 mm.



Catalog No.	\$	Product
BS4 73-3339		Serre Fine Tip Closing Clip, pkg. of 1

Holder for Vessel Segments

This triangular holder is used for holding vessel segments. One pair is required per vessel segment. It is constructed from stainless steel wire which is 0.3mm in diameter. The maximum vessel segment length is 8 mm (0.3 in)

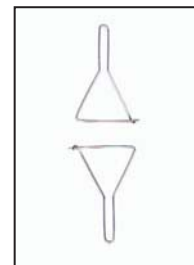
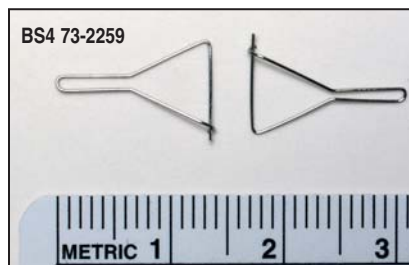

Catalog No.	\$	Product
BS4 73-2259		Holder for Vessel Segments, 1 pair

Holder for Vessel Segments, Twisted 90°

This triangular holder is used for holding vessel segments. One pair is required per vessel segment. The bottom triangle is twisted to hold the tissue at 90° from top holder. It is constructed from stainless steel wire which is 0.3mm in diameter. The maximum vessel segment length is 8 mm (0.3 in).

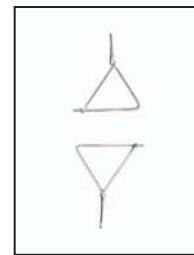
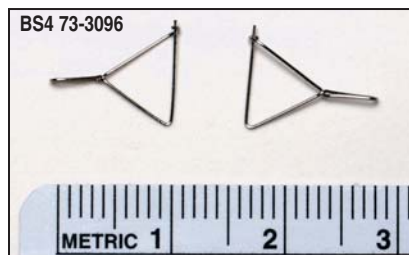

Catalog No.	\$	Product
BS4 73-3096		Holder for Vessel Segments, Lower Triangle Twisted by 90°, 1 pair

Mini Ball Joints

HSE-HA Mini Ball Joint Holders

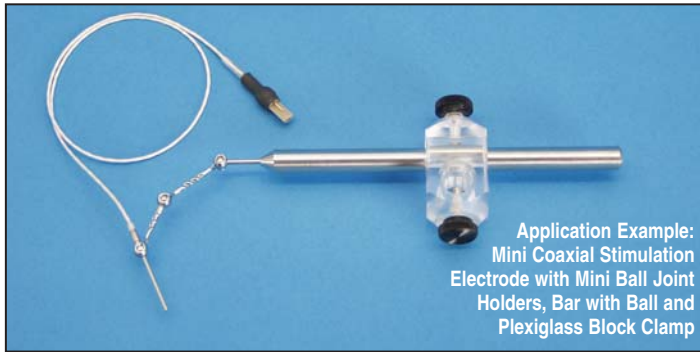

Mini Ball Joint Holder (Eye-Ball),
18, 23, or 35 mm Length



Link for Higher Loading Capacity for
2 Arms with Balls, 23 mm Length



Mini Ball Joint Holder (Ball-Ball),
18 mm Length



Universal Holder with Eye and Free End
for Fixation, 20 mm Length



Mini Ball Joint Holder (Eye-Eye),
23 or 42 mm Length



Plexiglass Block Clamp for Mounting
Bar BS4 73-0562 on Stand



BS4 73-0562

Experiments on isolated organs and tissues require the use of clamping devices for locating cannulae, probes and sensors in the correct position relative to the preparation. With the reduced size of modern murine preparations there is now a need for more sensitive devices, light in weight, freely adjustable, and requiring minimal force for adjustment.

HSE-HA mini holders consist of arms of different lengths which carry a ball or a wire clip (eye) on the ends. Several arms can be clipped together and the ball joint allows the holder to be moved into any configuration. Arms with special terminations are available to carry electrodes, mount flow probes or support intracardial balloons. A high-flexibility mount for crystal pickups maintains contact with the surface of the organ during its intrinsic movement.

All holder elements are made from stainless steel. The special design of ball joint ensures minimum size and permits perfectly smooth operation without any trace of spring-back. Mini holders remain rigid while carrying weights up to a few grams and are suitable for supporting tubing and small components.

Mini ball joint holders are ideal for use on small operating tables and especially inside small organ chambers where space is extremely limited. There are complete kits available for measuring isovolumetric IVP balloon pressure in mice hearts, ECG detection from mice hearts and stimulation of mice hearts. Other possibilities are: mounting of small flow probes on open chest experiments in mice or rats, mounting of cannulas on small isolated organs like liver, kidney, lung, hearts. A lot of further applications are possible. For self-created applications the following parts can be used.

Catalog No.	\$	Product
BS4 73-0566		Plexiglass Block Clamp for Mounting Bar BS4 73-0562 on a Stand
BS4 73-0562		Bar with Ball for Mounting on a Stand, D=8 mm, L=140 mm, Ball Size=5 mm
BS4 73-0174		Mini Ball Joint Holder, Eye-Eye, L=23 mm
BS4 73-0175		Mini Ball Joint Holder, Eye-Eye, L=42 mm
BS4 73-0176		Mini Ball Joint Holder, Eye-Ball, L=18 mm
BS4 73-0177		Mini Ball Joint Holder, Eye-Ball, L=23 mm
BS4 73-3321		Mini Ball Joint Holder, Eye-Ball, L=35 mm
BS4 73-0563		Mini Ball Joint Holder, Ball-Ball, L=18 mm
BS4 73-0564		Link for Higher Loading Capacity, for Two Arms with Balls, L=23 mm, for Combination with BS4 73-0562, BS4 73-0176, BS4 73-0177 and BS4 73-0563
BS4 73-0565		Universal Holder with Eye and Free End for Fixation of Ultrasonic Crystals, ECG Electrodes, etc., L=20 mm

NEW Bath/Immersion Thermostats



These bath/circulation Thermostats are economical stainless steel baths that provide temperature controlled water up to 120°C. Each unit has a control unit, cooling coil and pump. Pump connections are mounted on bath bridge.

- Up to 120°C
- Units with the latest microprocessor technology and PID control
- User-friendly menu guidance, operation with 3 keys
- Innovative high-power pump with electronic control
- Can be switched between internal and external circulation
- Minimum stray magnetic field
- Automatic self-tests
- Facility for simple recalibration by the user
- Safety through low-level protection and adjustable overtemperature cut-out, therefore suitable for use with both flammable and non-flammable liquids
- Display can be switched between °C and °F

Specifications

	E103	E111	E119
Temperature:			
Range	20 to 120°C	20 to 120°C	20 to 120°C
Control*	±0.05°C	±0.05°C	±0.05°C
Indications	1 line	1 line	1 line
Heater Power, kW	1.5 kW	1.5 kW	1.5 kW
Pump Output:			
L/min	17	17	17
Bar	0.4	0.4	0.4
Bath:			
Volume, L	2.5 to 3.5	9 to 12	12 to 18
Opening, mm	35 x 105	300 x 190	300 x 365
Depth, mm	150	150	150
Overall Dimension, H x W x D, mm	349 x 168 x 271	349 x 331 x 360	349 x 331 x 536

Catalog No.	\$	Model	Product
BS4 73-2802		E103	Thermostat, 115 V, 60 Hz
BS4 73-0125		E103	Thermostat, 230 V, 50 Hz
BS4 73-2982		E111	Thermostat, 115 V, 60 Hz
BS4 73-2482		E111	Thermostat, 230 V, 50 Hz
BS4 73-2983		E119	Thermostat, 115 V, 60 Hz
BS4 73-2483		E119	Thermostat, 230 V, 50 Hz

*Note: Operating temperature range with water cooling

NEW LAUDA Low-Temperature Thermostats ECO-line RE 207



- Innovative high-power pump with electronic control
- Can be switched between internal and external circulation
- Minimum stray magnetic field
- Automatic self-tests
- Facility for simple recalibration by the user
- Safety through low-level protection and adjustable overtemperature cut-out, therefore suitable for the use of both flammable and non-flammable liquids
- Display can be switched between °C and °F
- Clear 2-line LCD display with numbers and symbols. RS 232 C interface for computer connection

Additional Features:

- Factory calibration at 2 points
- Parallel display of actual and set temperature
- Messages for the various operating states in plain language
- Audible alarm for low level and over temperature
- Facility for remote fault indication through floating contact

These powerful, low-temperature thermostats have the latest microprocessor technology. The refrigerating system with energy-saving automatic compressor control is environmentally friendly through the use of CFC-free refrigerants. Recyclable through the use of CFC-free insulation. They are innovative and environmentally friendly bench units with a built-in refrigeration system. The ECO-line RE 207 are low-temperature thermostats which consist of a pump and the E200 control heads, together with a bath and refrigeration unit.

Specifications

Temperature:		Pump Output:	
Range	-35 to 200°C	L/min	17
Control, ±°C	±0.02°C	Bar	0.4
Indications	2 lines	Bath:	
Heater Power	2.25 kW	Volume, L	4 to 6
Cooling Capacity:		Opening, mm	150 x 130
At 20°C	0.3 kW	Depth, mm	160
Tmin*	0.06 kW at -30°C	Overall Dimension, H x W x D, mm	557 x 200 x 400

Catalog No.	\$	Model	Product
BS4 73-2981		RE 207	Low Temperature Thermostat, 115 V, 60 Hz
BS4 73-2481		RE 207	Low Temperature Thermostat, 230 V, 50 Hz

Data Acquisition Systems

HSE-HA ISOHEART® W for Isolated Heart Studies

Specialized Tools For Bioresearch

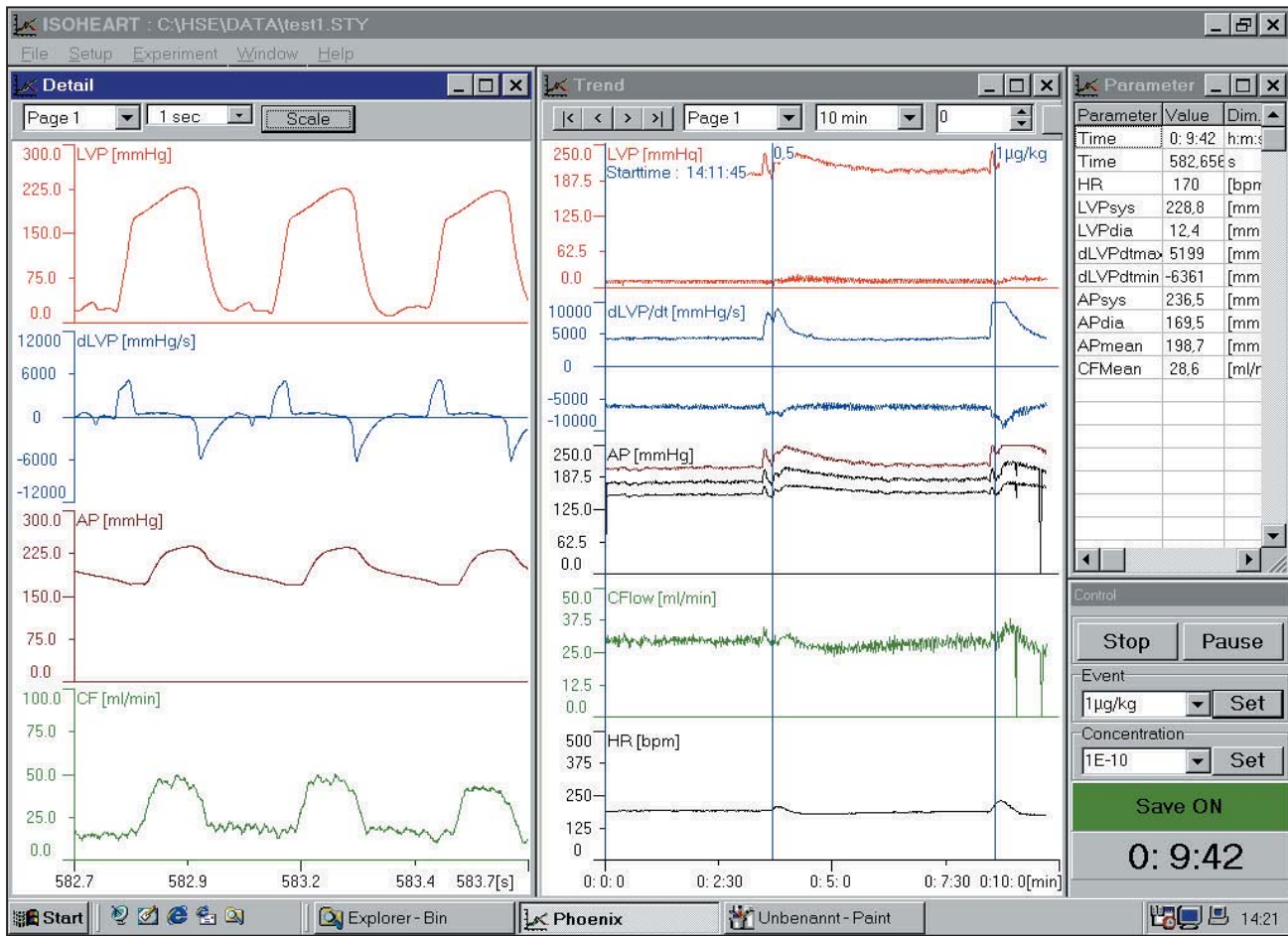

- 16 channel data acquisition software for isolated heart experiments
- For Windows® NT, 2000, and XP
- To measure signals such as: perfusion pressure, perfusion flow, left ventricular isovolumetric pressure, aortic pressure, aortic flow, atrial pressure, atrial flow, coronary flow, length measurement, pO₂, pCO₂, pH, temperature, etc.
- Easy to use, reduced settings by using configuration files
- Storage of raw data with possibility for replay. Complete experiments can be replayed
- Indication of the measured signals and parameters online in numerical tabular form or graphical detail and trend windows
- Data exchange interface by converting the data into the ASCII delimited format
- Monitoring of the experimental sequence by placing event markers and concentration information
- Very easy graphical selection of specific data points by cursors for evaluation, data reduction and export
- Export of a raw data sequence into ASCII delimited format

The HSE-HA ISOHEART software for Windows can be adapted to virtually any experimental investigation of isolated hearts (according to Langendorff or Working Heart). Acquisition can cover signals such as perfusion pressure, perfusion flow, left ventricular pressure, aortic pressure, aortic flow, atrial pressure, atrial flow, coronary flow, segment length or wall thickness measurement, pO₂, pCO₂, pH, temperature, etc. Various parameters can be derived from these signals, (e.g., systolic, diastolic, mean and rate (frequency) values for pressures); dP/dt; contractility index CI; minimal, maximal, and mean flows, etc. During data acquisition all acquired signals and derived parameters are stored on the hard disk and can be displayed on the screen.

The HSE-HA ISOHEART software is available in a basic version which includes the minimal necessary algorithms. It can be upgraded to a more complex system including all the available algorithms. The configuration of the system is defined in configuration files to reduce the amount of settings necessary and to ensure a stable and secure system. The user has only to calibrate the signals and to fix the graphics scaling. All the hardware definitions and the algorithms used are defined in the configuration files. This reduces the amount of information necessary in the SOP's and the possibilities of wrong settings. The configuration files can of course be changed and the software can be used in combination with a set of different configuration files to match the different experiments. ISOHEART is a menu-controlled software and employs special algorithms to calculate the standard parameters.

HSE-HA ISOHEART® W for Isolated Heart Studies

The HSE-HA ISOHEART software has a maximum of 16 channels, i.e. up to 16 different raw signals can be handled. The assignment of the signals to the individual channels is determined in the configuration files. The sample rate, the type of signals and the algorithm used for analysis are also defined in the configuration file. The arrangement of the graphic detail (raw signals) and trend (calculated parameters) is defined in the menu. The user has only to set up which of the available signals he wants to acquire and display, which of the possible parameters he wants to evaluate and display; to enter the experimental protocol and finally to calibrate before he starts the data acquisition.

HSE-HA Data Acquisition Hardware for ISOHEART Software is available in three versions:

- PLUGSYS Version**
 This version consists of the PCI A/D board DT301, ROM-DL, DIM and the cable for connecting to a DIM Data Interface Module installed in the PLUGSYS basic system case
- Stand Alone Version**
 This version consists of the PCI A/D board DT301, cable and a BNC input box where signals from external amplifiers can be connected.
- USB Stand Alone Version**
 This version consists of the 16 channel USB A/D converter box with BNC inputs and USB cable

Hardware Requirements for ISOHEART:

Both the PLUGSYS and Stand Alone Versions require the following computer hardware:

Computer	PC Pentium at least 500 MHz with one free PCI-slot,
RAM	128 MB of RAM
Operating System	Windows 2000/XP or Windows NT
Hard Disk Space	With at least 3.2 GB
Floppy Drive	1.44 MB
CD-ROM Drive	Required
Monitor	AGP graphic board and 19" monitor
Backup Media	MO drive, CD recorder or ZIP drive

Commonly Used Signals for Langendorff Preparation are:

LVP	isovolumetric LVP or contraction force
PP	perfusion pressure
CF	coronary flow
WT	wall thickness or left ventricle diameter
EG	electrogram
pO ₂ a / e	oxygen partial pressure in the affluent / effluent
pH	pH in the effluent

Commonly Used Signals for Working Heart Preparation are:

PrP	preload pressure
AoP	aortic pressure (afterload)
LVP	left Ventricular Pressure, measured with tip catheter
AF	aortic flow
CO	cardiac output (flow into left atrium)
WT	wall thickness or left ventricle diameter
EG	electrogram
pO ₂ a / e	oxygen partial pressure in the affluent / effluent
pH	pH in the effluent

It is also possible to acquire other signals (e.g., temperature); maximum is 16 signals.

Standard ISOHEART Software is able to Calculate Following Parameters Online:

From LVP signal:	LVP _{sys} , LVP _{dia} , LVP _{EDP} , dLVP/dt _{min} , dLVP/dt _{max} , heart rate, mean pressure
From all pressures:	systolic, diastolic and mean pressure
From all flows:	mean, maximum and minimum flow
From distance:	maximum, minimum and amplitude (max - min)
From electrogram:	heart rate
From pO₂, pCO₂ and pH:	mean value

For Specific Applications, Software Modules with More Parameters are available:

Advanced LVP:	Tau, Time to Peak, Relaxation Time, Contractility Index CI= $\frac{dp}{dt}_{max}/P$, Ejection Time
Advanced flow:	End Systolic Flow ESFL, End Diastolic Flow EDFL
MAP module:	Max, Min, Plateau, Amp, Rate, $\pm dv/dt$, duration at 10% of monophasic action potentials
Dimension module:	end-systolic length ESL, end-diastolic length EDL, +dL/dt, -dL/dt

Software Options for Controlling External Devices:

Control of programmable stimulator PSM
Triggering of an external stimulator

Catalog No.	\$	Product
BS4 73-0161		HSE-HA Data Acquisition Hardware PLUGSYS version
BS4 73-0235		HSE-HA Data Acquisition Hardware stand alone version
BS4 73-3330		HSE-USB Data Acquisition Hardware, Stand Alone Version
BS4 73-0162		Software HSE-HA ISOHEART W
BS4 73-0237		Option LVP Advanced Module
BS4 73-0238		Option Flow Advanced Module
BS4 73-2715		Option Monophasic Action Potential Module
BS4 73-2716		Option Dimensions Module
BS4 73-0224		Software Module for PSM Control

Data Acquisition Systems

HSE-HA ACAD® W for Isolated Tissue Studies

Specialized Tools For Bioresearch

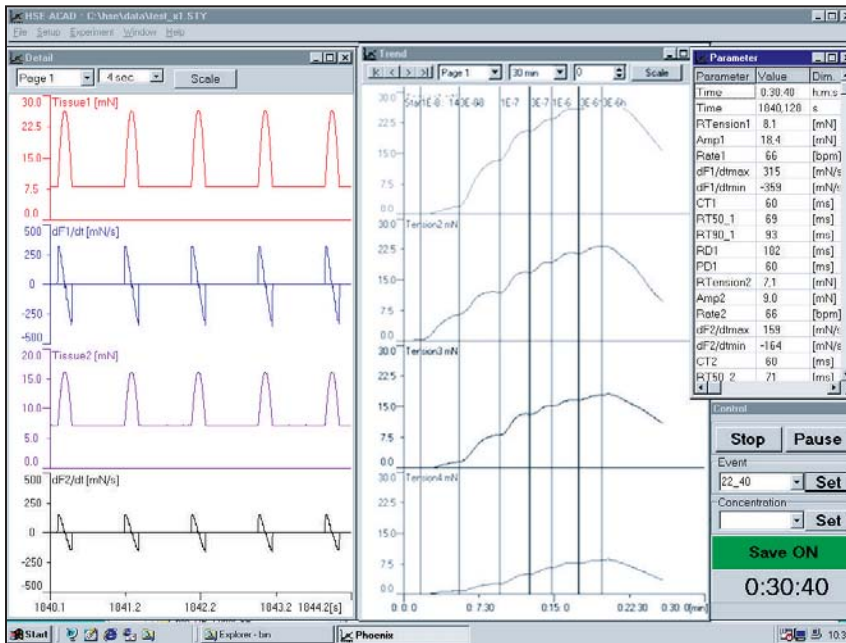

The HSE-HA ACAD software can be adapted to virtually any experimental investigation in tissue bath experiments. It is possible to acquire signals from isotonic (displacement) or isometric (force) measurements. The isotonic displacement measurement is used on smooth muscles, for example on ileum, ductus deferens, lung strips, also bladder... Isometric force measurement is used with tracheal muscle, atrium, papillary muscle, aortic rings, veins or other vessel rings. Experiments on spontaneously beating or electrically stimulated tissues are also possible. Various parameters can be derived from these signals depending on the model used. During data acquisition all acquired signals and derived parameters are stored on the hard disc and can be displayed graphically on the screen.

The HSE-HA ACAD software is available in a basic version which includes the minimal necessary algorithms to evaluate the resting tension. This version can be upgraded to a more complex system including all the available algorithms. The configuration of the system is defined in configuration files to reduce the settings necessary and to ensure a stable and secure system. The user has only to calibrate the signals and to fix the graphics scaling, all the hardware definitions and the algorithms used are defined in the configuration files. This reduces the amount of information necessary in the standard operating procedures and the possibilities of wrong settings. The configuration files can of course be changed and the software can be used in combination with a set of different configuration files to match the different experiments.

The ACAD software controls preload adjustment and flushing as well as data acquisition and calculation. It was developed for use with our universal setup for isolated organ studies. It can also be used with any existing manually-operated organ bath setup. It is possible to use ACAD only for data acquisition without controlling or with full controlling in order to automate all routine operations and provide full processing and printing facilities for the results.

The HSE-HA ACAD software has a maximum of 16 channels, i.e. up to 16 different raw signals can be handled. The assignment of the signals to the individual channels is determined in the configuration files. The sample rate, the type of signals and the algorithm used for analysis are also defined in the configuration file. The arrangement of the graphic detail (raw signals) and trend (calculated parameters) is defined in the menu. The user has only to set up which of the available signals he wants to acquire and display, which of the possible parameters he wants to evaluate and display; to enter the experimental protocol and finally to calibrate before he starts the data acquisition. The ACAD software operates only with the PLUGSYS hardware when automatic flushing, pretensioning or electrical stimulation using PSM modules is required!

- 16-channel data acquisition software for isolated tissue studies
- For Windows® NT, 2000 or XP
- To measure isometric or isotonic tissue contractions
- Can handle smooth muscle as well as beating or electrically stimulated muscle
- Possibilities of controlling electrical stimulation, pretension adjustment and flushing
- Easy to use, reduced settings by using configuration files
- Storage of raw data with possibility for replay; complete experiments can be replayed
- Indication of the measured signals and parameters online in numerical tabular form or graphical detail and trend windows
- Data exchange interface by converting the data into the ASCII delimited format
- Monitoring of the experimental sequence by placing event markers and concentration information
- Very easy graphical selection of specific data points by cursors for evaluation, data reduction and export
- Export of a raw data sequence into ASCII delimited format

The HSE-HA Data Acquisition Hardware for PULMODYN W Software is available in three versions:

• PLUGSYS Version

This version consists of the PCI A/D board DT301, ROM-DL, DIM and the cable for connecting to a DIM Data Interface Module installed in the PLUGSYS basic system case, in Section I of this Catalog

• Stand Alone Version

This version consists of the PCI A/D board DT301, cable and a BNC input box where signals from external amplifiers can be connected

• USB Stand Alone Version

This version consists of the 16 channel USB A/D converter box with BNC inputs and USB cable

HSE-HA ACAD[®] W for Isolated Tissue Studies

Hardware Requirements for ACAD:

Both the PLUGSYS and Stand Alone versions require the following computer hardware:

Computer	PC Pentium, at least 500 MHz with one free PCI-slot
RAM	128 MB of RAM
Operating System	Windows [®] 2000/XP, NT
Hard Disk Space	At least 3.2 GB
Floppy Drive	1.44 MB
CD-ROM Drive	Required
Monitor	AGP graphic board and 19" monitor
Backup Media	MO drive, CD recorder or ZIP drive

For computer-controlled applications it is necessary to have a PLUGSYS Maincase and the PLUGSYS Version of the Data Acquisition Hardware with DIM-D extension. The PLUGSYS Maincase can receive the Transducer Amplifiers TAM-A. The housing takes also the Programmable Stimulator Modules PSM or the PPG Module for triggering an external Stimulator. In addition to these modules an Output Driver Module ODM is used to control the pumps and valves via an Extension Unit. This Extension Unit contains the electronics to switch pumps, valves and automatic vernier controls.

- Manual Control Box MCB Type for manual draining or refilling of the organ bath or to adjust preload manually
- HSE-HA Flushing Unit with pumps and valves to drain and refill the organ bath
- Motor Vernier Control for isometric measurements for each organ can be used to set preload automatically

The basic version of HSE-ACAD for smooth muscles calculates the following parameter:

- Resting tension

The option for beating tissues additionally calculates the following parameters:

- Amplitude, Rate, $\pm dF/dt$

The advanced version for stimulated beating tissues additionally calculates the following parameters:

- Amplitude, Rate, $\pm dF/dt$, Contraction time CT, Relaxation time RT, Response duration RD, Peak duration PD, Latency period LP

This version can be used for beating tissues and stimulated beating tissues such as atrium or papillary muscle. To calculate the Latency Period computer-controlled stimulation of the tissue is necessary. It is possible to use the HSE-HA Programmable Stimulator PSM or to trigger an external stimulator by using a PPG module.

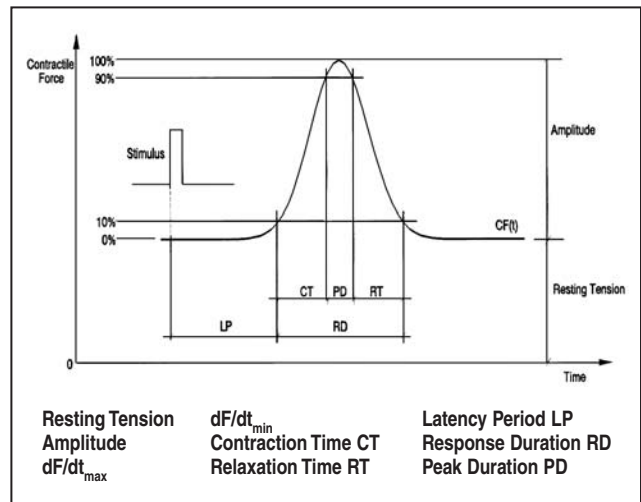

Catalog No. \$ Product

BS4 73-0161	HSE-HA Data Acquisition Hardware PLUGSYS Version
BS4 73-0235	HSE-HA Data Acquisition Hardware Stand Alone Version
BS4 73-3330	HSE-USB Data Acquisition Hardware, Stand Alone Version
BS4 73-1688	Software HSE-HA ACAD W
BS4 73-1715	Option Beating Tissue Module
BS4 73-1703	Option Beating and Stimulated Tissue Module
BS4 73-0224	Option PSM and PPG Control Module
BS4 73-1705	Option Resting Tension (Preload) Module
BS4 73-1687	Option Flushing Control Module

Control models are on request and mainly customized, call for information.

Harvard Apparatus Isolated Heart Perfusion Apparatus



This System includes the components below

The 'Langendorff' preparation offers extreme flexibility for handling the perfusing fluids:

- The perfusing fluid reservoir serves as a Mariotte flask that maintains a constant perfusion pressure as the reservoir empties
- The perfusion pressure can be varied easily and rapidly by varying the height of the reservoir above the perfused heart. The height of the reservoir can be varied through 62.5 cm (24 in)
- To rapidly change perfusing fluids a second reservoir (offered as an accessory) can be added to the second frame upright and a 'Y' connector can connect it to the glass warming coil

The 1 liter reservoir supplies a constant head of perfusate. The perfusate flow rate is controlled by one of two methods. If the Reservoir cap is off, the flow rate is controlled directly by a pinch clamp on the outlet tubing. If the reservoir cap is tightly sealed, a Mariotte flask is created and the flow rate is set by the perfusion pressure. The height of the reservoir determines this pressure which in turn sets the rate of air allowed to enter the reservoir. As air enters, the perfusate flows out. This reservoir is placed in the three-prong, spring clip reservoir holder that has a 20 cm (8 in) long tube that slips on the top of a rod and locks in place by a knurled set screw. Using this set screw the height of the Reservoir can be varied from 15 cm (6 in) above the top of the rod down to the top of the rod. If it is necessary to lower the reservoir even more, the holder has a clamp mounted on one side that can locate the holder at any point on the rod. The total vertical movement of the reservoir is 62.5 cm (24 in) above the top of the fluid warming coil. The aeration reservoir is mounted to the side of the reservoir holder. The perfusing fluid is led from the main reservoir to the aeration reservoir by tubing provided. The aeration stone is mounted on the end of 2 m (6.6 ft) tubing. This aeration stone fits inside the aeration reservoir and provides a high level of oxygenation to the perfusant.

The transparent, heavy plastic water bath which warms the perfusant measures, H x W x D, 15.5 x 16.5 x 14 cm (6-1/4 x 6-1/2 x 5-1/2 in) and has a capacity of 3.6 liters. The bath is heated by two simple sturdy cartridge elements that are mounted through the front of the tank near the bottom and extend 5 cm (2 in) into it. These heating elements have a combined rating of 80 watts. The temperature of the water is controlled by a front panel dial graduated from 15° to 45°C by 5°C graduations. A metal tube mounted inside the bath carries a sensitive thermistor sensing bead. Once stabilized, this system maintains the water temperature within 0.5°C of the desired temperature. The front panel of the water bath has two indicator lights. One illuminates when the bath is plugged into the AC line. The second illuminates whenever the heating circuit is energized. A screw-in fuse holder is also mounted on the front panel for easy access. A drain hole with tubing, a plug and a tapered plastic cone are located in the bottom of the water tank. The soft rubber bung that carries the stem of the warming coil fits into the cone making a leakproof joint. The glass warming coil for the perfusing fluid is 5 cm (2 in) diameter by 9 cm (3-1/2 in) long. It has a capacity of approximately 35 ml. The stem of the warming coil connects to the heart cannula with tubing and a pinch clamp controls the flow of the warmed perfusate. A clamp and grooved rod are supplied for securing the bottom of the excised mammalian heart.

The heart cannula has openings to accommodate both a manometer and thermometer. The manometer has a fixed clamp for mounting directly to a crossbar and is connected to the cannula by tubing. The scale reads 0 to 250 mmHg and is free to move up and down behind the tubing to facilitate zero adjustment. The glass thermometer is straight, 10 cm (4 in) long and graduated from 0° to 50°C by 0.1°C increments. It is mounted in a rubber bung and fits into the side arm of the heart cannula. All of the clamps, stands and rods supplied with this apparatus are from our Stronghold™ line, see pages O22 to O27. Two light pulleys are supplied and carry a thread from the heart to a transducer (not supplied) or writing point.

- For the perfusion of the excised mammalian heart
- Large capacity warming bath with temperature controlled to 0.5°C
- Free-standing apparatus uses minimal bench space

Catalog No. Product

System Components

BS4 50-0496	Constant Head 1 L Reservoir
BS4 50-0488	Reservoir Holder
BS4 50-0587	Aeration Reservoir
BS4 50-0595	Aeration Stone with Tubing
BS4 50-0537	Bath Assembly
BS4 50-2898	Tubing 1 m (3-1/4 ft)
BS4 50-0554	Warming Coil
BS4 50-2369	Rubber Bung
BS4 50-2914	Screwclips, 2
BS4 50-0562	Red Rubber Bung
BS4 50-0563	Cannula
BS4 50-6287	Thermometer
BS4 50-0588	Manometer
BS4 50-7624	Plug
BS4 50-0596	Tying Rod
BS4 53-2262	Pulleys, qty. of 2
BS4 53-2512	Rod, 150 mm (6 in)
BS4 53-2522	Rod, 250 mm (10 in)
BS4 53-2530	Rod, 500 mm (20 in)
BS4 53-2550	Rods, 750 mm (29 in), qty. of 3
BS4 53-2336	Extra Weight Rectangular Laboratory Stand Base, qty. of 2
BS4 53-2102	Small Clamp with Extension Stem
BS4 53-2012	Closed Connectors, qty. of 5
BS4 53-2032	'T' Connectors, qty. of 3
BS4 53-2062	Large 360° Rotation Connector
BS4 53-2244	Male-Female Hinged Adapter
BS4 50-0686	Ink Pen with Lever
BS4 50-7681	Replacement Ink Pen
BS4 50-0678	Brodie Lever

Catalog No.	\$	Product
BS4 50-2864		Harvard Apparatus Isolated Heart Perfusion Apparatus, 115 VAC, 60 Hz
BS4 50-2872		Harvard Apparatus Isolated Heart Perfusion Apparatus, 230 VAC, 50 Hz
BS4 50-2880		Second Reservoir Set Includes Reservoir Holder, 1 L Reservoir, glass Aeration Reservoir and Aeration Stone. Set comes complete with tubing and connectors for mounting on second rod of Perfusion Apparatus

Harvard Apparatus Isolated Tissue Bath Sets



- All glassware jacketed
- Warming water in closed circuit so there is no contamination or mess
- Flexible and interchangeable
- Components easily disassemble for cleaning or changing experiments

Set Components

All four of the Harvard Apparatus Isolated Tissue Bath Sets are supplied complete with:

- BS4 50-0470** Pharmacology Laboratory Stand, see page O31
- BS4 50-0488** Reservoir Holder, see page K34
- BS4 50-0496** Constant Head 1 Liter Reservoir, see page K34
- BS4 50-0504** Spring Clip Clamp without Support Rod, see page K35
- BS4 50-0512** Jacketed Warming Coil, see page K35
- BS4 50-0520** Spring Clip Clamp with Support Rod, see page K35
- BS4 50-0645** Flow and Return Tubes
- BS4 50-2575** Closed Connector, see page O29

The additional components supplied with each specific set are listed to the right.

This unique assembly of tissue bath components provides the utmost convenience and flexibility in either the research or student laboratory. Four sets are offered. Three of the sets provide the basic components for specific experiments with smooth muscles, rat diaphragms and mammalian hearts with Langendorff preparations. A universal set provides enough components to make any of the other three sets diagrammed. All of the components are interchangeable, permitting additional components to be added later.

All glassware is jacketed so that the warming water is pumped through a closed circuit only; there are no open baths that can become contaminated. The tissue vessels and the heart chamber all have the same outside circumference so that they can be easily interchanged in the same spring clip holder.

Since apparatus is mounted on a heavy pharmacology stand, minimum bench space is occupied. The experimental areas are clearly visible and easy to get to. The open assembly makes taking samples and adding wash or test fluids an easy task. The sensibility of the design is evident by examining the reservoir.

When the cap is fitted, the reservoir becomes a mariotte flask. Fluid can leave the reservoir only as air enters it via the small bore tube which runs from the cap to the bottom of the flask maintaining a constant pressure. This is ideal for heart perfusion. When the cap is removed, the flow is slightly greater and can be controlled by a tube clamp on the outlet pipe (or on the outlet of the aeration reservoir if used). This mode is ideal for rapid filling/flushing of tissue vessels. In both cases the pressure can be varied by changing the height of the reservoir above the preparation.

Isolated Tissue Bath Set

The Universal Isolated Tissue Bath Set includes all of the components listed to the left plus the components listed in the sets for rat diaphragm and mammalian heart perfusion (Langendorff) plus one BS4 50-0538 20 ml jacketed general tissue vessel. All three sets below can be assembled (individually) from this universal set. For descriptions of the individual components, see the following pages.

Catalog No.	\$	Product
BS4 50-0405		Universal Isolated Tissue Bath Set

Set for Smooth Muscle

Catalog No.	\$	Product
BS4 50-0413		Set for Smooth Muscle

Includes all items listed to left plus:

BS4 50-0538		20 ml Jacketed General Tissue Vessel
BS4 50-0553		Detachable Stem for Jacketed General Tissue Vessel

Set for Rat Diaphragm

Catalog No.	\$	Product
BS4 50-0421		Set for Rat Diaphragm

Includes all items listed to above left plus:

BS4 50-0546		100 ml Jacketed General Tissue Vessel
BS4 50-0553		Detachable Stem for Jacketed General Tissue Vessel
BS4 50-0561		Phrenic Nerve Electrode with Oxygen Bubbler

Set for Mammalian Heart Perfusion (Langendorff)

Catalog No.	\$	Product
BS4 50-0439		Set for Mammalian Heart Perfusion (Langendorff)

Includes all items listed to above left plus:

BS4 50-0579		Jacketed Heart Chamber
BS4 50-0587		Aeration Reservoir
BS4 50-0595		Aeration Stone with Tubing
BS4 50-0603		Heart Mounting Junction Block
BS4 50-0611		Manometer
BS4 50-0629		Horizontal Thermometer with Rubber Bung
BS4 50-0637		Heart Cannula
BS4 50-0702		Double Pulley Holder
BS4 50-0710		Fixed Mount Pulley, 25 mm, pkg. of 2

Isolated Tissue Bath Set Components



Constant Head 1 Liter Reservoir

This 1 liter polyethylene reservoir supplies a constant head of wash or test fluid by a simple mechanism. The tight fitting cap is pierced by a length of small bore stainless steel tubing. Cemented to the stainless steel tubing is a length of flexible tubing that reaches the bottom of the reservoir. The fluid can flow from the bottom outlet and into the warming system only as an air bubble goes down through the tubing in the cap to the bottom of the reservoir and bubbles up to the top of the reservoir. This air inlet can be adjusted to any desired feed rate. Conversely, the cap can be removed and the quantity of the fluid leaving the reservoir can be controlled by the pinch clamp provided on the outlet tubing. It comes supplied with 25 cm (10 in) length of 7 mm ID x 10.5 mm OD outlet tubing with plastic male connectors, a precision threaded pinch clamp, and a tapered plastic connector.

Catalog No.	\$	Product
BS4 50-0496		Constant Head Reservoir, 1 L



Aeration Reservoir

This glass Aeration Reservoir attaches by means of spring clips to the main Reservoir Holder, see above. The fluid flows from the main Reservoir to the side limb of the Aeration Reservoir through flexible tubing and a plastic connector (supplied). The BS4 50-0595 Aeration Stone with Tubing described below is placed in the Aeration Reservoir. The bottom has a piece of flexible tubing and

a tapered plastic connector for attachment to the Jacketed Warming Coil. The Aeration Reservoir has an inside diameter of 2 cm (3/4 in) and is 20 cm (8 in) long. It comes supplied with two 5 cm (2 in) lengths of 7 mm ID x 10.5 mm OD tubing.

Catalog No.	\$	Product
BS4 50-0587		Aeration Reservoir



Reservoir Holder

This sturdy, steel Holder is coated with white paint and has a 10.8 cm (4-1/4 in) diameter plate mounted on top of a 13 mm (1/2 in) ID, 19.7 cm (7-3/4 in) long tubular rod. The plate has three pronged spring clips to securely hold the BS4 50-0496 Constant Head 1 Liter Reservoir. Two smaller 2.5 cm (1 in) spring clips attached to one of these prongs hold the BS4 50-0587 Aeration Reservoir. The tube slips over the rod of the BS4 50-0470 Pharmacology Stand and locks in place with a knurled set screw 3.2 cm (1-1/4 in) from the bottom of the tube. A 13 mm (1/2

in) open sided connector, mounted to the base of the plate can also be used to mount the Holder to the Pharmacology Stand. Since the rod of the Pharmacology Stand is 72 cm (28 in) long, the maximum height of the Reservoir is 86 cm (34 in) and the minimum height of the Reservoir is 20 cm (8 in). Thus, the maximum distance between the Holder placed as high as possible using the set screw on the tube and as low as possible using the open sided connector on the top plate is 66 cm (26 in).

Catalog No.	\$	Product
BS4 50-0488		Reservoir Holder



Aeration Stone with Tubing

This sintered Aeration Stone is mounted on one end of 2 m (6 ft) long translucent PVC 4 mm ID x 7 mm OD (3/16 x 5/16 in) tubing that connects to the laboratory oxygen supply. The Stone measures, H x W x D, 14 x 14 x 30 mm (1/2 x 1/2 x 1-1/5 in) and fits inside the BS4 50-0587 Aeration Reservoir. It serves as a gas bubbler to provide suitable oxygenation to the perfusate.

Catalog No.	\$	Product
BS4 50-0595		Aeration Stone with Tubing

Isolated Tissue Bath Set Components



Detachable Stem Jacketed General Tissue Vessels

These glass Jacketed General Tissue Vessels consist of a tissue chamber with a cone joint and a detachable stem. The chamber has an outside diameter of 55 mm (2-1/4 in). The bottom of the tissue chamber is fitted with a 14/23 cone joint to accept the BS4 50-2096 Detachable Stem (not supplied) or BS4 50-0553 Detachable Stem with tubing, springs and pinch clamps. This stem attaches to the tissue chamber with two springs (included). The tissue chamber has three limbs. Two of the limbs serve as the inlet and outlet for the water warming circuit. The third is the level tube which maintains a constant volume of perfusate in the chamber.

Harvard Apparatus offers this Tissue Vessel in two sizes with approximate capacities of 20 and 100 ml. Supplied with flexible tubing with plastic connectors for all three limbs. The 100 ml Tissue Vessel is primarily intended for work with rat diaphragms. Stems and springs must be purchased separately.

Catalog No.	\$	Product
BS4 50-0538		20 ml General Tissue Vessel, Detachable Stem, Inner Chamber 20 x 85 mm (3/4 x 3-1/2 in)
BS4 50-0546		100 ml General Tissue Vessel, Detachable Stem, Inner Chamber 45 x 100 mm (1-3/4 x 4 in)
BS4 50-0520		Spring Clip Clamp with Support Rod, see page P6
BS4 50-0504		Spring Clip Clamp without Support Rod, see page P6
BS4 50-2450		Tissue Chamber Only without Tubing, 20 ml without Tubing
BS4 50-2492		Tissue Chamber Only without Tubing, 100 ml without Tubing
BS4 50-2096		Detachable Stem Only to Fit 14/23 Cone Joint
BS4 50-2088		Springs, set of 2
BS4 50-0553		Detachable Stem for Jacketed General Tissue Vessels, see description to right

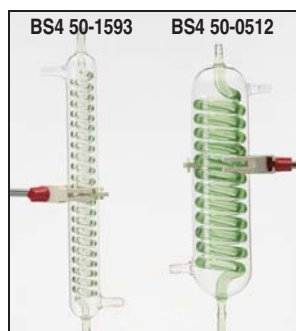

Jacketed Warming Coils

These glass-jacketed warming coils have tight, even spirals and four riffled limbs. Two limbs serve as inlet and outlet for the perfusate. The other two limbs serve as inlet and outlet for the warm water circuit. Harvard Apparatus offers this warming coil in two sizes with approximate capacities of 30 and 100 ml. Supplied with four pieces of flexible, translucent, PVC tubing permanently attached for both the warm water circuit and the perfusate. The tubing for the warm water circuit is 8 mm ID x 12 mm OD and has large plastic connectors attached. The tubing for the perfusate is 7 mm ID x 10.5 mm OD and has small plastic connectors attached.

Catalog No.	\$	Capacity (approx.)	Jacket (ID x L, approx.)
BS4 50-1593		30 ml	35 x 280 mm (1.4 x 11 in)
BS4 50-0512		100 ml	65 x 250 mm (2-1/2 x 9.8 in)
BS4 50-0504			Spring Clip Clamp without Support Rod for Holding 100 ml Warming Coil



Jacketed Heart Chamber

This glass Jacketed Heart Chamber has an outside diameter of 60 mm (2.4 in) and an inner chamber measuring 40 x 75 mm (1-1/2 x 3 in). The bottom has an opening of 20 mm (3/4 in) in diameter for passing the measuring line to a lever or transducer. Supplied with tapered plastic connectors and 8 mm ID x 12 mm OD flexible translucent PVC tubing for the inlet and outlet limbs. One piece of tubing has a female connector; the other has a male connector.

Catalog No.	\$	Product
BS4 50-0579		Jacketed Heart Chamber
BS4 50-0520		Spring Clip Clamp with Support Rod
BS4 50-0504		Spring Clip Clamp without Support Rod



For more Jacketed Tissue Vessels, see page K37.

Isolated Tissue Bath Set Components

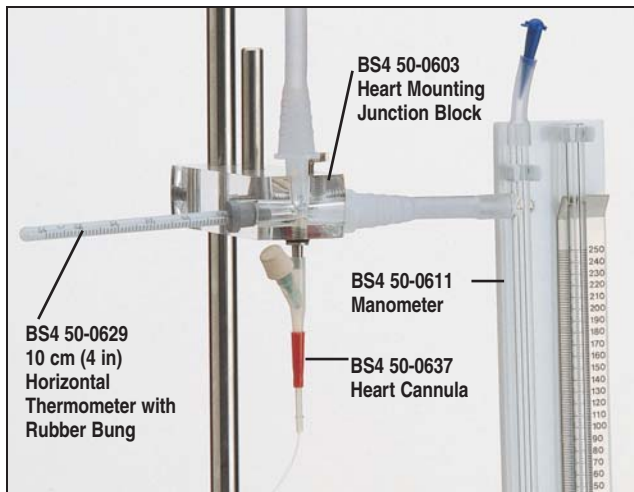

Heart Mounting Junction Block

This clear acrylic 25 mm (1 in) thick Junction Block brings together the Heart Cannula, Thermometer, Manometer and the warmed perfusate from the Jacketed Fluid Warming Coil. The block is 10.2 cm (4 in) long and 3.8 cm (1-1/2 in) wide and has a 13 mm (1/2 in) hole and locking screw for mounting on the rod of the BS4 50-0470 Pharmacology Stand, see page O31.

The front of the Block has three 9.5 mm (3/8 in) tapered holes and a stainless steel Luer connector joining at a central cavity. The Luer connector accepts the BS4 50-0637 Heart Cannula on which the excised heart is attached. The BS4 50-0629 Thermometer with Rubber Bung is fitted into one of the horizontal holes and the BS4 50-0611 Manometer is fitted into the other. The plastic male connector from the BS4 50-0512 Jacketed Warming Coil fits into the top hole. The Block has a vertical 9.5 mm (3/8 in) hole with locking screw for a 7.5 cm (3 in) long mounting rod provided. This is used for mounting transducers or kymograph levers. A horizontal 9.5 mm (3/8 in) hole and locking screw accepts the mounting rod of the BS4 50-0611 Manometer.

Catalog No. \$ Product

BS4 50-0603 Heart Mounting Junction Box

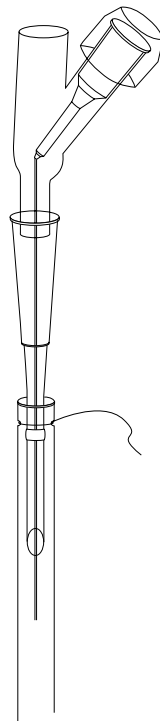

- To mount the heart and pass the warmed perfusant to the heart
- Allows direct injections into the heart chambers

Heart Cannula

The cannula is made completely of nylon and has three Luer fittings. The bottom section to which the aorta is tied is detachable and fits to the bottom Luer fitting of the main body of the cannula. A shoulder on the plastic spigot facilitates tying the aorta, see diagram. The main cannula itself fits to a Luer fitting on the bottom of the BS4 50-0603 Junction Block. The third Luer fitting is located off the side of the main body of the cannula. A tiny funnel in this limb has a fine 0.36 mm nylon tube attached to it that extends down through the cannula and protrudes through the bottom, thereby serving as a fine injection cannula inside the main cannula. This limb is covered with a rubber cap, through which a needle can be passed to make injections directly into the heart chambers.

Catalog No. \$ Product

BS4 50-0637 Heart Cannula



Manometer

This sturdy Manometer with heavy-walled 3.2 mm (1/8 in) tubing is mounted on a white 4.8 mm (3/16 in) thick plastic block measuring 5 x 24.1 cm (2 x 9-1/2 in). It is mounted on a 10.2 cm (4 in) long, 9.5 mm (3/8 in) diameter rod for mounting in the BS4 50-0603 Junction Block, or a clamp. The scale is bright plated metal calibrated from 0 to 250 mmHg. The scale slides up and down behind the tubing for easy zeroing.

Catalog No. \$ Product

BS4 50-0611 Manometer

Tissue Vessels

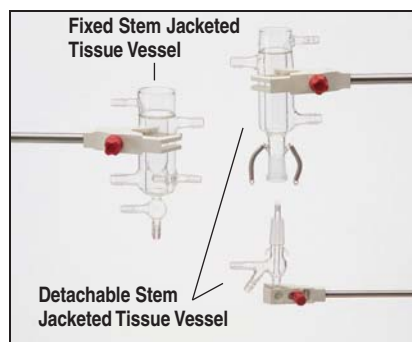
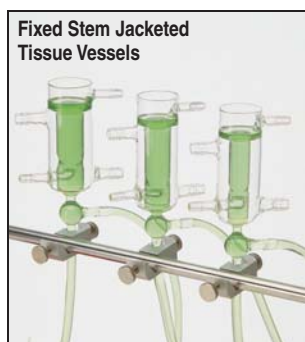

Harvard Apparatus Jacketed Tissue Vessels

- Accommodate all standard isolated pharmacological preparations
- Both 'fixed' and 'detachable' stem types — each available in three sizes
- Equally suitable for research or student use
- 'Detachable' stem types allow researcher to change vessels and leave stem portion connected into circuit for ease of attaching preparation
- Hook in vessels anchors preparations
- Sintered airway tube in each vessel for oxygenation
- Level tube in each vessel maintains level of fluid
- Side limbs are in constant position in all vessels to facilitate interchange or substitution

These glass Harvard Apparatus Jacketed Tissue Vessels accommodate all standard isolated pharmacological preparations and are equally suited for research or student use. The vessels are offered in both 'fixed' one piece form or in 'detachable' two piece form. The detachable stem jacketed tissue vessels are particularly useful because vessels of the same or different capacities can be interchanged without taking the cone portion out of the external circuit. The cone joints are all 14/23. A hook is provided inside each vessel to anchor the preparation. Each vessel also has

an airway tube with a No. 1 porosity, sintered disc for oxygenation. The level tube at the top of each vessel maintains a constant level of fluid in the vessel. It is close to the side wall and clear of the bath. All side limbs are located in a constant position with the same diameter openings for more convenient interchangeability or substitution. The two limbs for connection to the BS4 50-1932 Thermocirculator are purposely made slightly larger than the fluid preparation limbs to increase the flow of warming water and minimize temperature gradients that could occur with multiple set-ups. The detachable jacketed tissue vessels are supplied complete with the tissue chamber, detachable stem and two stainless steel springs to hold the cone in the socket. The springs connect to hooks on each fitting.

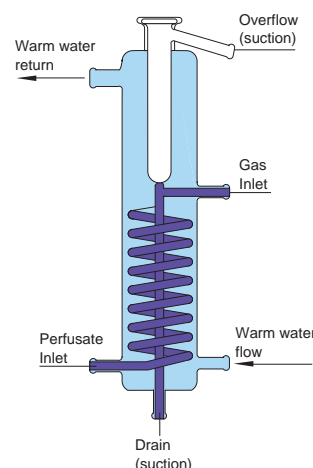

Harvard Apparatus 'Bennett Type' Isolated Tissue Vessel

A distinct advantage of this improved glass Isolated Tissue Vessel is that substances added to the tissue chamber cannot diffuse out. It is similar in construction to other Harvard Apparatus Tissue Vessels in that the chamber containing the tissue chamber and warming coil are kept at a constant temperature by means of the jacketed water assembly. In operation, water of the desired temperature is circulated through the water jacket and physiological solution (perfusate) is passed through the warming coil to fill the tissue chamber. Gas (oxygen, carbon dioxide, etc.) is introduced into the chamber through a 6 mm OD diameter orifice. The action of the gas entering the chamber forms an effective seal that separates the contents of the tissue chamber from the warming coil. This prevents diffusion of the bath contents into the coil. The 'Bennett Type' Tissue Vessel has a capacity of 20 ml. The inner chamber diameter is 17.5 mm (2/3 in).

Catalog No. \$ Product

BS4 50-1569		Fixed Stem Jacketed Tissue Vessel, 10 ml capacity, 14 mm ID
BS4 50-1577		Fixed Stem Jacketed Tissue Vessel, 20 ml capacity, 18 mm ID
BS4 50-1585		Fixed Stem Jacketed Tissue Vessel, 25 ml capacity, 20 mm ID
BS4 50-1510		Detachable Stem Jacketed Tissue Vessel, 10 ml capacity, 14 mm ID
BS4 50-1528		Detachable Stem Jacketed Tissue Vessel, 20 ml capacity, 18 mm ID

Spares for Detachable Stem Vessels

BS4 50-1536		Detachable Stem Jacketed Tissue Vessel, 25 ml capacity, 20 mm ID
BS4 50-1445		Tissue Chamber, 10 ml
BS4 50-1478		Tissue Chamber, 20 ml
BS4 50-1486		Tissue Chamber, 25 ml
BS4 50-2096		Stem Only to fit 14/23 Cone Joint of Tissue Chamber
BS4 50-2088		Springs, pkg. of 2

Catalog No. \$ Product

BS4 50-8341		Bennett Type Isolated Tissue Vessel, 20 ml
-------------	--	--

Harvard Apparatus 'Baker' Jacketed Mammalian Heart Perfusion Sets

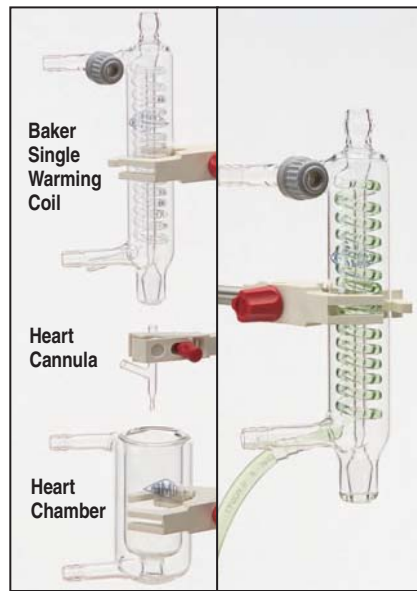
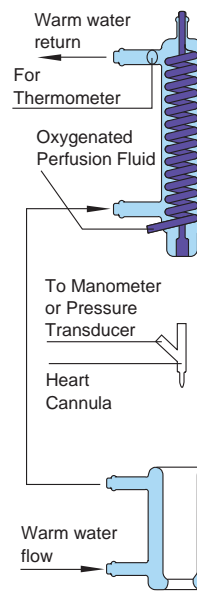
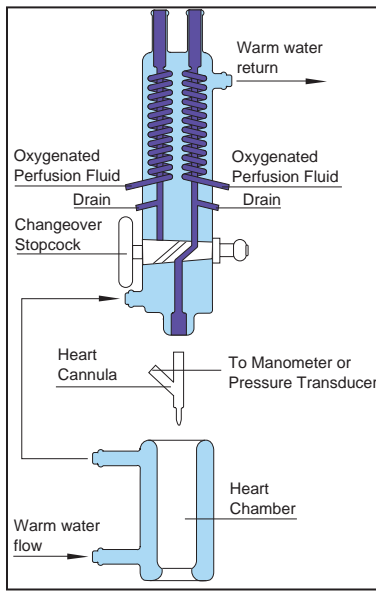

Double 'Baker' Heart Perfusion Set

This Set consists of three elements:

- Double Baker Warming Coil
- Baker Heart Cannula
- Baker Heart Chamber

- Maintains constant temperature of the heart regardless of coronary flow
- Eliminates any bubbles that may enter the cannula
- Restricts the drying of the heart tissue

The Double Baker Coil has two separate fluid warming coils heated by the same bath. This allows the heart to be perfused with different solutions. Oxygenated perfusion fluid enters the bottom of each Warming Coil and is warmed by circulating water. Each coil connects to a straight tube that runs axially through the coil.

A piece of pinched silicone rubber at the top of the straight tube acts as a bubble trap and injection site. The changeover stopcock design (see diagram) allows one coil to be used for perfusion while the other is being warmed.

The excised heart is suspended from the Heart Cannula which fits into the bottom straight tube of the Warming Coil. This tube has a rubber tube attached to it to ensure a tight fit. A side arm of the Heart Cannula is used to monitor pressure by means of a manometer or pressure transducer (not included). This Heart Cannula with the excised heart is then enclosed in the Jacketed Heart Chamber.

The Jacketed Heart Chamber is warmed by the same water from the warming coil and encloses the heart suspended from the Heart Cannula. An aperture at the bottom of the chamber allows a thread to pass through for transmitting ventricular contractions and drips from coronary outflow.

Single 'Baker' Heart Perfusion Set

Harvard Apparatus also offers a Baker Type Single Warming Coil Set. This Set contains the same components as the Double Baker Heart Perfusion Set except that it comes with a Baker Single Warming Coil in place of the Double Warming Coil.

Catalog No.	\$	Product
BS4 50-0876		Single Baker Heart Perfusion Set
BS4 50-8358		Single Baker Warming Coil
BS4 50-8366		Baker Heart Cannula
BS4 50-8374		Baker Heart Chamber

The Double Baker Warming Coil is interchangeable with the BS4 50-8358 Single Baker Warming Coil.

Catalog No.	\$	Product
BS4 50-0884		Double Baker Heart Perfusion Set
BS4 50-8382		Double Baker Warming Coil
BS4 50-8366		Baker Heart Cannula
BS4 50-8374		Baker Heart Chamber

Tissue Bath Sets



Basic Double Tissue Bath Set with BS4 50-0652 Complete Simple Lever Assembly*



Basic Single Tissue Bath Set with BS4 50-0652 Complete Simple Lever Assembly*

Basic Double/Basic Single Tissue Bath Sets

- Temperature automatically held within 0.5°C
- Dial graduated from 15 to 45°C in 5° increments
- Fixed stem tissue vessels supplied as standard

Research Double Tissue Bath Set

- Temp. automatically held within 0.5°C
- Dial graduated from 15° to 45°C in 5° increments
- Large 11.2 L water bath capacity for stable temp. in coils and tissue vessels
- Magnetic stirrer ensures uniform temp.
- 250 watts of heating power for fast heat-up time
- Warming coils lie flat against sides of tank, leaving center free for procedures
- 400 ml capacity flat perfusate warming coils ensure sufficient supply of temp. controlled perfusate for lengthy assays
- Detachable stem tissue vessel, for increased convenience when changing tissue vessels (tissue chamber can be removed without disturbing stem or disconnecting tubing for warmed perfusate and drainage)

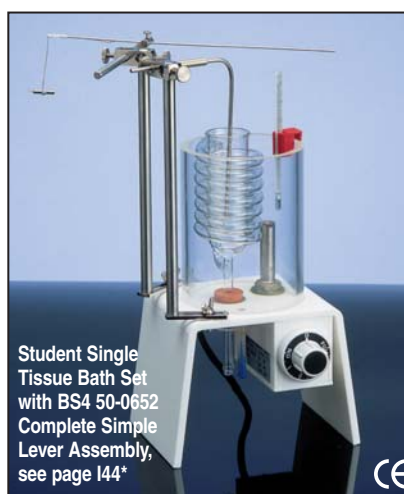

Student Single Tissue Bath Set with BS4 50-0652 Complete Simple Lever Assembly, see page I44*

Student Single Tissue Bath Set

- Manual temperature control
- Offers superior visibility and access for student
- Side limb of the special fixed stem student tissue vessel is curved upward making it easy to connect to the spiral perfusate warming coil

Specifications and Ordering Information for Harvard Apparatus Tissue Bath Sets

	Research Double Tissue Bath Set 115 VAC, 60 Hz/230 VAC, 50 Hz	Basic Double Tissue Bath Set 115 VAC, 60 Hz/230 VAC, 50 Hz	Basic Single Tissue Bath Set 115 VAC, 60 Hz/230 VAC, 50 Hz	Student Single Tissue Bath Set 115 VAC, 60 Hz/230 VAC, 50 Hz
Heated Water Bath:				
Heater Power	250 W	80 W	80 W	50 W
Temperature Control	Automatic within 0.5°C	Automatic within 0.5°C	Automatic within 0.5°C	Manual
Magnetic Stirrer	Yes	No	No	No
Capacity	11.2 L	4.7 L	3.6 L	0.8 L
Dimensions, H x W x D	18 x 29 x 21.5 cm (7.25 x 11.5 x 8.5 in)	15.5 x 21.5 x 14 cm (6.25 x 8.5 x 5.5 in)	15.5 x 16.5 x 14 cm (6.25 x 6.5 x 5.5 in)	12.5 x 10 cm (H x D) (5 x 4 in)
Tissue Vessel(s):				
Quantity per Set	2	2	1	1
Type Supplied	Detachable Stem	Fixed Stem	Fixed Stem	Student Fixed Stem
Perfusate Warming Coils:				
Type	Flat Coil	Spiral Coil	Spiral Coil	Spiral Coil
Capacity per Vessel	200 ml	35 ml	35 ml	35 ml
Thermometer Length	15 cm	10 cm	10 cm	10 cm
Catalog No.	BS4 50-2146 / BS4 50-2153	BS4 50-2120 / BS4 50-2138	BS4 50-2104 / BS4 50-2112	BS4 50-0306 / BS4 50-0314
\$				

Note: Water Bath in photograph is older style. See page K40 for details on newer style Baths.

上海达域仪器有限公司 电话: 021-56479651 网址: www.dayulab.com 邮箱: Sales@dayulab.com
U.S. Toll Free: (800) 272-2775 • Fax: (508) 429-5732 • Online: www.harvardapparatus.com

Heated Water Baths



BS4 50-2286

The walls of these Baths are heavy, 6 mm (1/4 in) thick, transparent plastic so that the specimen can be constantly and easily observed. The two sides of the Baths are extended to form a stand. The heating control housing is made of white plastic that is corrosion proof and serves as an excellent electrical insulator from the heaters. A drain hole with tubing and a plug are located in the tank.

All of the baths, with the exception of the student water bath feature a sophisticated digital temperature control system. The control system provides an LED display of the current water temperature, accurate to within half a degree and temperature stabilization. The user may select a water temperature anywhere between 15 and 45 degrees using front panel mounted keys. A float switch provides a safety cut off should the water level fall below the minimum permitted level, thus preventing any damage occurring to the structure of the unit from excessive heat build up.

The model shown is the Single Tissue bath, however the Double and Research Baths are very similar in appearance with just their overall dimensions differing.

Research Heated Water Bath

This Heated Water Bath is for the most demanding research work. Its two heaters provide 250 watts of combined power. The heaters are mounted through the front of the tank near the bottom and extend 100 mm (4 in) into it. A magnetic stirrer (which can be activated independently from the heaters) in the bottom of the tank slowly circulates the water to ensure uniform temperature.

Catalog No.	\$	Product
BS4 50-2328		Research Heated Water Bath, 115 VAC, 60 Hz
BS4 50-2336		Research Heated Water Bath, 230 VAC, 50 Hz

Basic Double and Basic Single Heated Water Baths

Two 40-watt heaters that are mounted through the front of the tank near the bottom and extend 5 cm (2 in) into these Water Baths. These Baths are identical except that the Basic Double Water Bath has a larger tank to accommodate two Tissue Vessels.

Catalog No.	\$	Product
BS4 50-2302		Basic Double Heated Water Bath, 115 VAC, 60 Hz
BS4 50-2310		Basic Double Heated Water Bath, 230 VAC, 50 Hz
BS4 50-2286		Basic Single Heated Water Bath, 115 VAC, 60 Hz
BS4 50-2294		Basic Single Heated Water Bath, 230 VAC, 50 Hz

Student Heated Water Bath

A 50-watt heater is mounted off center through the bottom of the tank. An energy regulator mounted on the front of the Bath manually controls the temperature. The dial has a position for 'full energy' while the bath is being brought up to its desired temperature and ten graduations so that the working temperature can be easily maintained.

Catalog No.	\$	Product
BS4 50-2260		Student Heated Water Bath, 115 VAC, 60 Hz
BS4 50-2278		Student Heated Water Bath, 230 VAC, 50 Hz