

Accessories

DZ301 Bellows set (for DL330B, DE30BR)

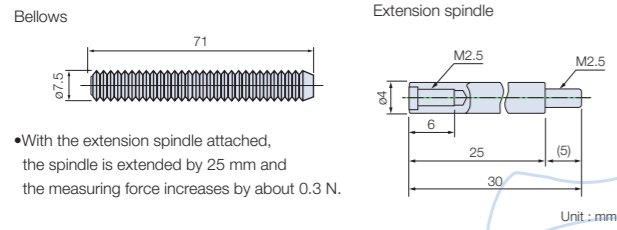

DZ302 Bellows set (for DE12BR)

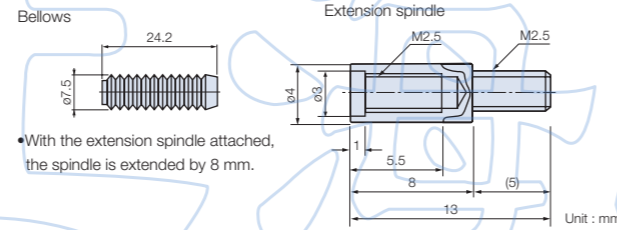

DZ-501 Digital gauging stand (for U60B, DG10B to DG100B, DE-30BR)

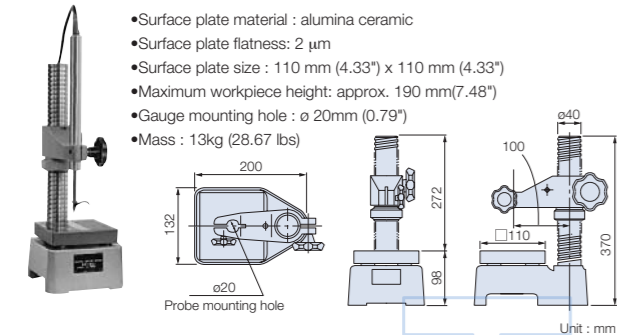

DZ521 Gauging stand (for DG805BL/810B/810BL, U Series, DE12BR)

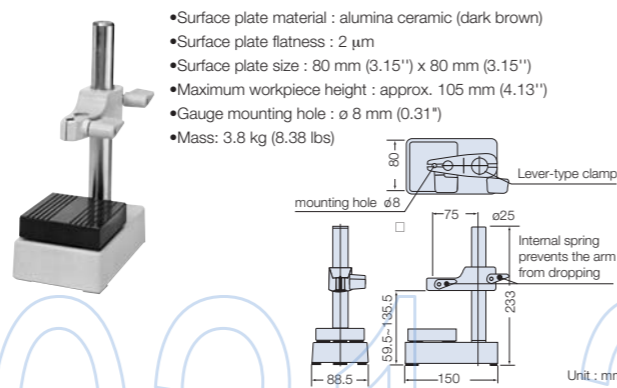

SZ70-1 Adapter

SZ70-1 is required for connecting the following scale units and counters:
Gauge unit : DE-BR Series, DG-B Series
Counter : LH71A, LH72-3, LY71 and LY72
* Adapter DZ51 is also required

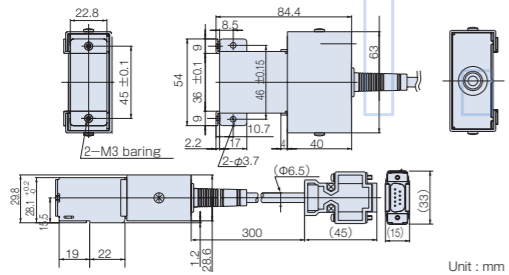

DZ-191 Coupling

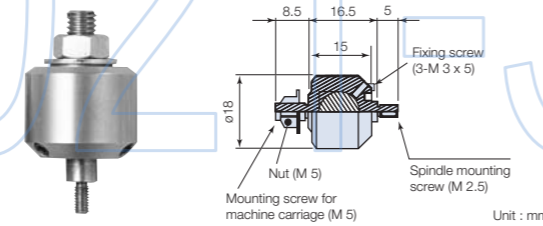

DZ-5100 Feeler set

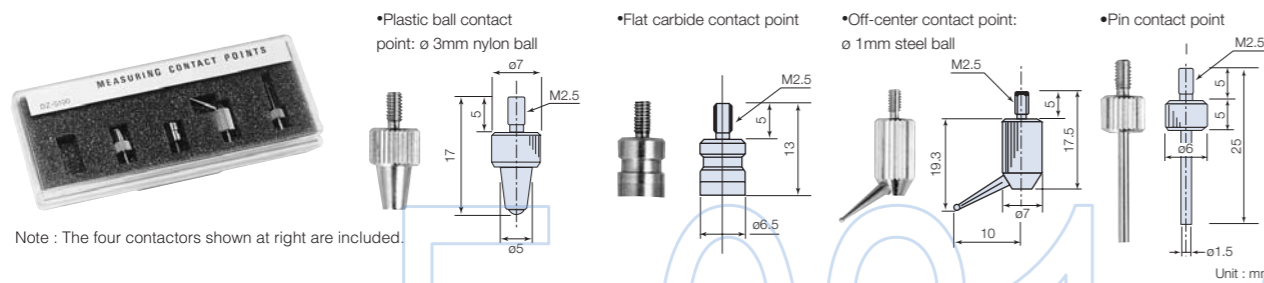

SZ70-2 Adapter

SZ70-2 is required for connecting the following scale units and counters:
Gauge unit: DE-BR Counterunit: LT30 Interface unit: MG series

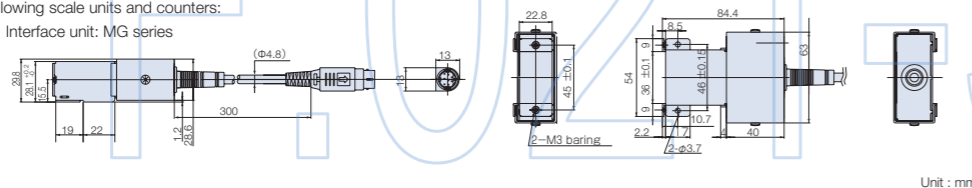

*Please refer to p54 for the details of the screw.

Accessories (for DK series)

DZ-122 Feeler (for DK Series, DG10B and DG50B)

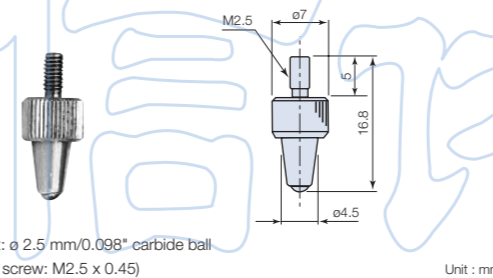

DZ-123 Feeler (for DK Series, DG805BL/810B/810BL)

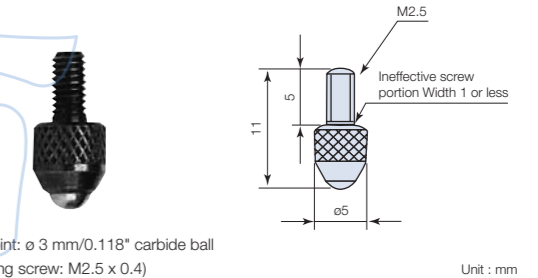

DZ-531 Digital gauging stand (for DK110, DG110B)

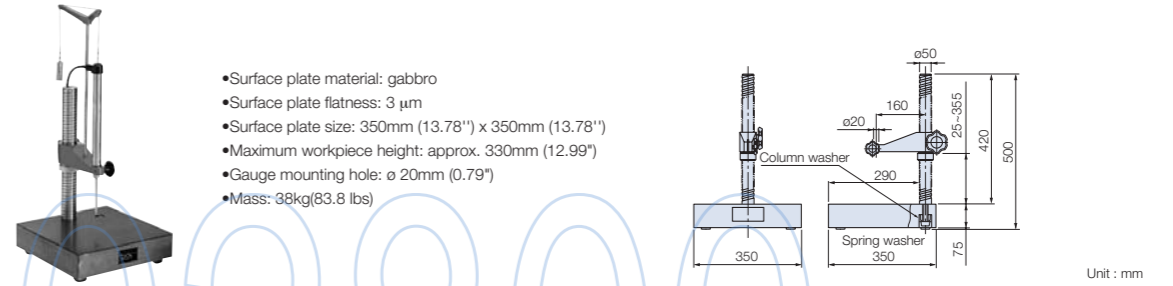

DZ-581 Measuring force balancer (for DK110, DG110B)

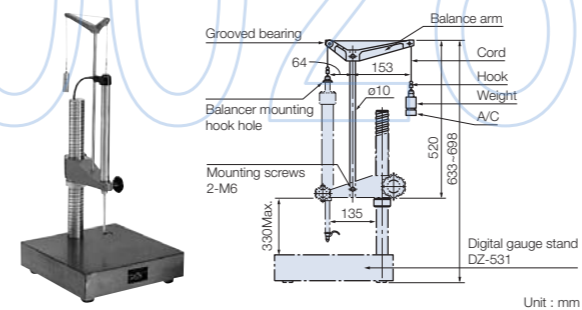

Weight

- No weight: 1.55±0.15N(155±15gf)
- B: 1.0±0.15N(100±15gf)
- B+A: 0.7±0.15N(70±15gf)
- B+C: 0.3±0.15N(30±15gf)

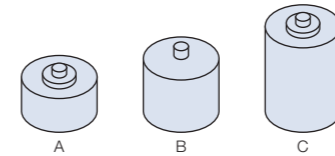

DZ-121 Feeler (for DK100, DG100BP/BN)

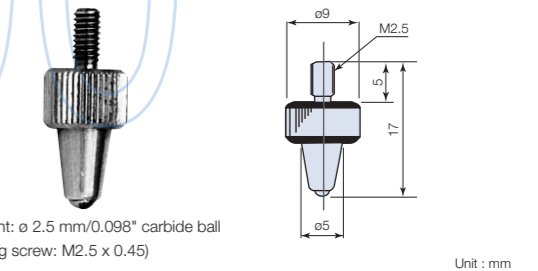

Other accessories

- CE08 Extension cable : CE08-01 (1m) , 03 (3m) , 05 (5m) , 10 (10m) , 15 (15m)
- CE22 Extension cable (Ahead in pieces) : CE22-01 (1m) , 03 (3m) , 05 (5m) , 10 (10m)
- CK-T Extension cable (Winding-proof) : CK-T12 (1m) , T13 (3m) , T14 (5m) , T15 (10m)

*Please refer to p54 for the details of the screw.

DZ-191 Coupling

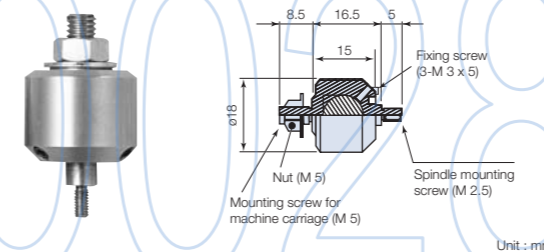

Accessories (for DGB series)

DZ51 (Relay adapter) For connections of DG-B, DL-BR, DL-B and DT12/32N/P* to LG, LH and LY displays



*To connect the DT12/32N/P, use the DZ51 in combination with the MT10 detector.

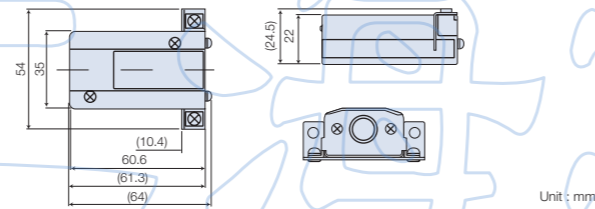

Unit : mm

DZ-501 Digital gauging stand (for DG10B to DG100B, DE-30BR)



- Surface plate material: alumina ceramic
- Surface plate flatness: 2 μm
- Surface plate size: 110 mm (4.33") x 110 mm (4.33")
- Maximum workpiece height: approx. 190 mm (7.48")
- Gauge mounting hole: $\phi 20$ mm (0.79")
- Mass: 13kg (28.67 lbs)

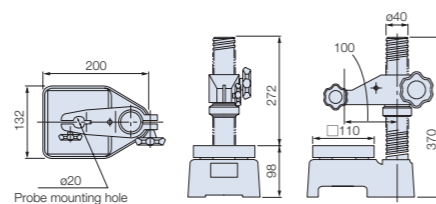

Unit : mm

DZ174-010/025/050 Air lifter (for DG10B to DG50B)

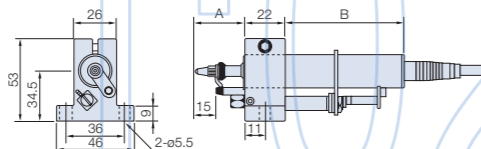
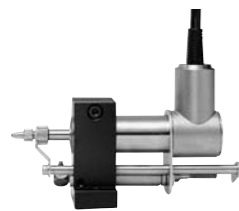

Measuring unit	A	B	Measuring unit	A	B
DG10BP/BN	32.5	75.5	DG25BS	47.5	98.5
DG10BS	32.5	56	DG25BL	47.5	98.5
DG25BP/BN	47.5	118	DG50BP/BN	72	200

Unit : mm

DZ-122 Feeler (for DG10B to DG50B)



- Contact point: $\phi 2.5$ mm/0.098" carbide ball tip (mounting screw: M2.5 x 0.45)

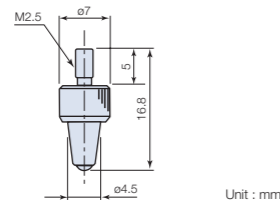

Unit : mm

DZ-100 Roller feeler (for DT Series, DG-B Series: except for DG155BP/205BP)

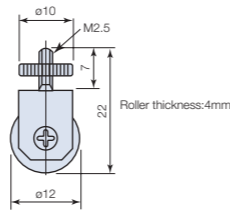

Unit : mm

DZ-181 Magnetic contact point feeler (for DG155BP/205BP)

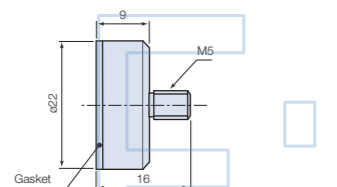

Unit : mm

DZ-191 Coupling

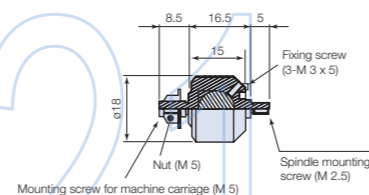

Unit : mm

DZ-801 Air lifter (for DG805BL/810BL)

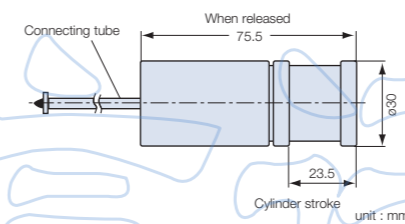
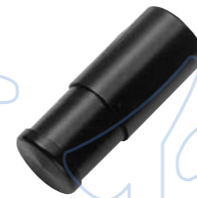

DZ-161 Lift lever (for DG-B except DG155BP/205BP; standard accessory for the DG110B)

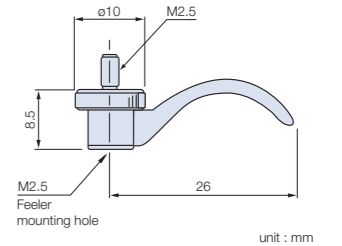

DZ-531 Digital gauging stand (for DK110, DG110B)



- Surface plate material: gabbro
- Surface plate flatness: 3 μm
- Surface plate size: 350mm (13.78") x 350mm (13.78")
- Maximum workpiece height: approx. 330mm (12.99")
- Gauge mounting hole: $\phi 20$ mm (0.79")
- Mass: 38kg(83.8 lbs)

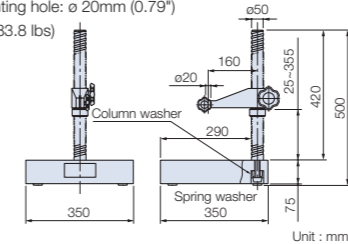

Unit : mm

DZ-581 Measuring force balancer (for DK110, DG110B)

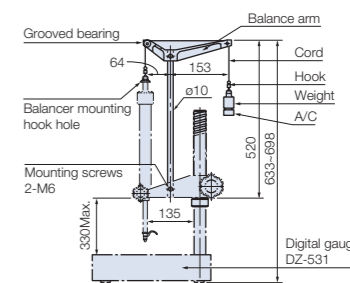

Unit : mm

- Weight
- No weight: 1.55±0.15N(155±15gf)
 - B: 1.0±0.15N(100±15gf)
 - B+A: 0.7±0.15N(70±15gf)
 - B+C: 0.3±0.15N(30±15gf)

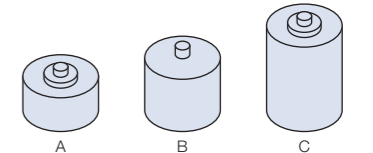

DZ-5100 Feeler set

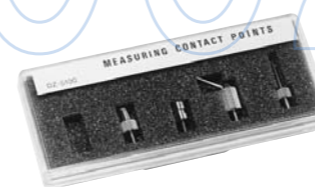

- Plastic ball contact point: $\phi 3$ mm nylon ball
- Flat carbide contact point
- Off-center contact point: $\phi 1$ mm steel ball
- Pin contact point

Note: The four contactors shown at right are included.

SZ70-1 Adapter

SZ70-1 is required for connecting the following scale units and counters:

Gauge unit : DE-BR Series, DG-B Series

Counter : LH71A/72, LY71 and LY72

* Adapter DZ51 is also required

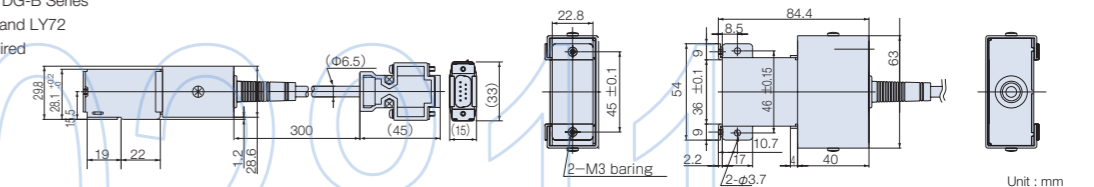

*Please refer to p54 for the details of the screw.