

# Ø22 mm系列

# 按钮及指示灯

产品目录





# Ø22 mm系列 按钮及指示灯

XB2B金属系列	按钮				带灯按钮
					
	平头按钮 <b>XB2BA●●C</b> 带1常开或1常闭触点 第5页	带功能符号平头按钮 <b>XB2BA●●●●C</b> 带1常开或1常闭触点 第6页	带罩按钮 <b>XB2BP●●C</b> 带1常开或1常闭触点 第5页	蘑菇头按钮, Ø40mm <b>XB2BC●●C</b> 带1常开或1常闭触点 第5页	交直流24V或交流220V, 含LED <b>XB2BW●●●●C</b> 带1常开触点 第8页
	急停按钮	选择开关		钥匙开关	
					
	旋转复位, 红色 <b>XB2BS●●●C</b> 带1常闭触点 第6页	拉拔复位, 红色 <b>XB2BT(X)●●C</b> 带1常闭触点 第6页	标准手柄 2或3位置, 保持或自动回中心位 <b>XB2BD●●●C</b> , 带1常开或2常开或1常闭触点 第7页	长手柄 2或3位置, 保持或自动回中心位 <b>XB2BJ●●●C</b> , 带1常开或2常开或1常闭触点 第7页	2或3位置, 保持或自动回中心位 <b>XB2BG●●●C</b> , 带1常开或2常开或1常闭触点 第7页
XB5A塑料系列 (模块式)	急停按钮	按钮	选择开关	钥匙开关	带灯按钮
					
	旋转复位, 红色 <b>XB5AS●●●C</b> 带1常闭触点 第20页	平头按钮 <b>XB5AA●●●C</b> 带1常开或1常闭触点 第20页	2或3位置, 保持 <b>XB5AD●●●C</b> 带1常开或2常开触点 第20页	2或3位置, 保持 <b>XB5AG●●●C</b> 带1常开或2常开触点 第20页	交直流24V, 交流110V 交流220V或交流380V <b>XB5AW●●●●C</b> 带1常开触点 第21页
XB7E塑料系列 (一体式)	按钮				
					
	一体式平头按钮 <b>XB7EA●●●C</b> 带1常开或2常开或1C/O触点 第26页				
指示灯和蜂鸣器	通用型指示灯	优化型指示灯	蜂鸣器		
					
	交直流24V, 交直流48V 直流110V, 交流110V 直流220V, 交流220V 交流380V, 含LED <b>XB2BV●●●●LC</b> 第17页	交直流24V 直流110V, 交流110V 直流220V, 交流220V 交流380V, 含LED <b>XB7EV●●●●C</b> 第27页	交直流24V 交流110V, 交流220V 持续声音, 灰色 <b>XB2BS●●C</b> 第17页		

# XB2B 金属系列按钮 Ø22 mm

## 特性

### 环境

符合标准	IEC 60947-5-1, EN 60 947-5-1, GB/T 14048.1-93, GB/14048.5-93
防护处理	标准版本: “TC” 和 “TH”
环境温度	工作温度: - 25 ~ +70 °C, 贮存温度: - 40 ~ +70 °C
抗振性	蘑菇头按钮: 8 g, 其它按钮及指示灯: 15 g (40 Hz < 频率 < 500 Hz), 符合IEC 68-2-6
抗冲击	按钮: 70 g, 蘑菇头按钮: 15 g, 选择开关: 200 g, 符合 IEC 68-2-27
电子冲击保护	I 级, 符合 IEC 536 和 NF C 20-030
防护等级	IP65: 平头及凸头, 带或不带指示灯, 按钮 (安装)
符合 IEC 529 和 NF C 20-010	IP66: 带罩按钮
机械寿命	按钮: 3 百万次操作, “紧急停止” 按钮: 30 万次操作

### 触点特性

额定工作特性	$\sim$ AC-15: A600 或 $U_e = 240\text{ V}$ 和 $I_e = 3\text{ A}$ $\text{---}$ DC-13: Q600 或 $U_e = 250\text{ V}$ 和 $I_e = 0.27\text{ A}$ 符合 IEC 947-5-1 附录 A
额定绝缘电压	$U_i = 600\text{ V}$ , 污染等级 3, 符合 IEC 60947-1, $U_i = 600\text{ V}$
额定耐冲击电压	$U_{imp} = 6\text{ kV}$ 符合 IEC 947-1
触头动作	慢断 (常闭或常开), 常闭触点为肯定断开
可靠工作	安全装置 (蘑菇头 “急停” 按钮): 常闭触点分断可靠, 符合 IEC 60947-5-1 第 3 部分
操作压力	平头和凸头按钮 - 带 1 常开触点: 1 daN - 带 1 常闭触点: 0.8 daN 辅助触点 - 常开: + 0.5 daN - 常闭: + 0.3 daN
端子型号	符合 CENELEC EN 50013
短路保护	10 A 熔芯类型 gI 符合 IEC 269-1, VDE 0660-200
额定工作功率	符合 IEC 60947-5-1 附录 C. 应用范围 AC-15 和 DC-13. 操作频率: 3600 次操作/小时。 负载因数: 0.5

交流电源  $\sim$  50-60 Hz  
 $\infty$  感性电路

直流电源  $\text{---}$   
 开断功率 W  
 操作一百万次

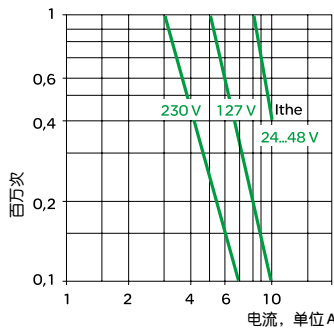

V	24	48	120
W	65	48	40

可靠性能	— 亿次操作中, 故障率 < 1 (可编程控制器输入, 24 V d.c.)
接线	- 螺旋压入式端子, 接线能力: 最小 $1 \times 0.5\text{ mm}^2$ , 最大, 带或不带接线端片: $2 \times 1.5\text{ mm}^2$ 或 $1 \times 2.5\text{ mm}^2$ - 6.3 mm Faston 端子 (根据需要)

# XB2B

## 通用型指示灯和蜂鸣器

### Ø22 mm

#### 特性

##### 带有LED的指示灯

符合标准	IEC 60947-5-1, EN 60 947-5-1, IEC 337
防护处理	标准版本: "TC"
环境温度	工作: - 25 ~ +70 °C。贮存: - 40 ~ +80°C
电子冲击保护	I级, 符合 IEC 536 和 NF C 20-030
防护等级	IP 65 符合 IEC 529 和 NF C 20-010
功率损耗	<b>XB2-BVB●C XB2-BVM●C: 24V 0.5W 220V 4.5W</b>
额定绝缘电压	50 - 380 V 符合 IEC 947-1 依类型而定
使用寿命	标称电压下可超过50,000 小时
电压极限	<b>XB2-BVB●C XB2-BVM●C: <math>0.8U_n \leq U \leq 1.1U_n</math></b>
端子型号	X1, X2 符合 CENELEC EN 50013
接线	螺旋压入式端子 接线能力: 最小 $1 \times 0.5 \text{ mm}^2$ , 最大 $2 \times 1.5 \text{ mm}^2$ 或 $1 \times 2.5 \text{ mm}^2$

#### 蜂鸣器特性

声音类型	连续蜂鸣
声音大小	100 dB / 10 cm
电气寿命	20000小时
额定电流	最大25 mA
电压波动	+/- 10%供电电压 冲击电压: 4 kV (线对地), 2 kV (线对线)

# XB2B 金属系列按钮 Ø22 mm

型号说明

模块型号  
ZB2B...C

完整型号  
XB2B...C

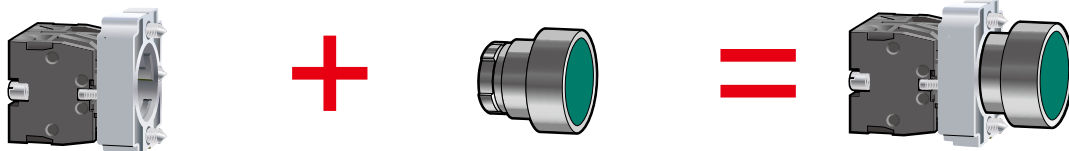

触点基座

按钮头

按钮

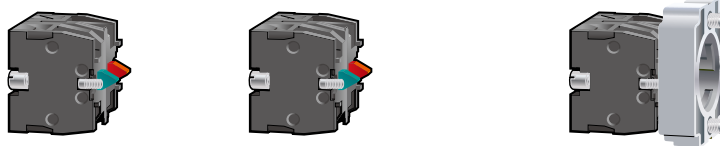

辅助触点的连接：最多可加至6付触点模块。

产品供货说明：  
XB2B系列产品以分体模块形式供货，模块型号为ZB2B...C。

组成和附件

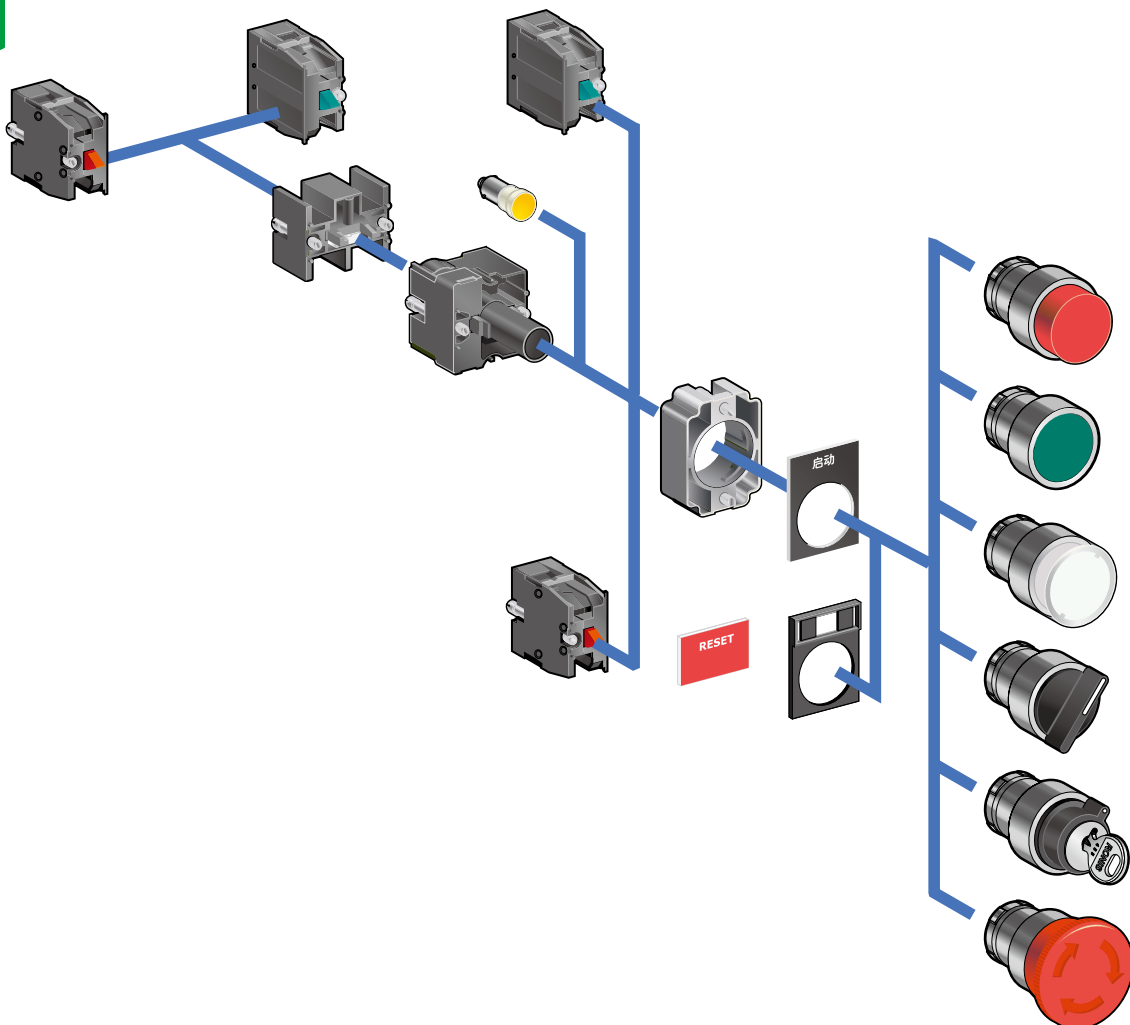

# XB2B

## 金属系列按钮

### Ø22 mm

## 按钮

## 弹簧复位按钮

说明	颜色	触点类型		型号	重量	尺寸
		常开	常闭			
 XB2BA**C	平头按钮	○	1	<b>XB2BA11C</b>	0.070	
	●	1	<b>XB2BA21C</b>	0.070		
	●	1	<b>XB2BA31C</b>	0.070		
	●	1	<b>XB2BA51C</b>	0.070		
	●	1	<b>XB2BA61C</b>	0.070		
	●	1	<b>XB2BA22C</b>	0.070		
	●	1	<b>XB2BA42C</b>	0.070		
 XB2BL**C	凸头按钮	●	1	<b>XB2BL21C</b>	0.070	
	●	1	<b>XB2BL31C</b>	0.070		
	●	1	<b>XB2BL51C</b>	0.070		
	●	1	<b>XB2BL61C</b>	0.070		
	●	1	<b>XB2BL22C</b>	0.070		
	●	1	<b>XB2BL42C</b>	0.070		
 XB2BP**C	带罩按钮	●	1	<b>XB2BP21C</b>	0.070	
	●	1	<b>XB2BP31C</b>	0.070		
	●	1	<b>XB2BP51C</b>	0.070		
	●	1	<b>XB2BP61C</b>	0.070		
	●	1	<b>XB2BP42C</b>	0.070		
 XB2BC**C	蘑菇头按钮 Ø40 mm	●	1	<b>XB2BC21C</b>	0.090	
	●	1	<b>XB2BC31C</b>	0.090		
	●	1	<b>XB2BC51C</b>	0.090		
	●	1	<b>XB2BC61C</b>	0.090		
	●	1	<b>XB2BC42C</b>	0.090		
 XB2BR**C	蘑菇头按钮 Ø60 mm	●	1	<b>XB2BR21C</b>	0.095	
	●	1	<b>XB2BR42C</b>	0.095		

# XB2B

## 金属系列按钮

### Ø22 mm

## 按钮

## 带功能符号的弹簧复位按钮

说明	标记 颜色	触点类型		型号	重量	尺寸
		常开	常闭			
 XB2BA****C	⎓	1		<b>XB2BA3311C</b>	0.070	
	↑	1		<b>XB2BA3341C</b>	0.070	
	↑	1		<b>XB2BA3351C</b>	0.070	
	⊘		1	<b>XB2BA4322C</b>	0.070	
	STOP		1	<b>XB2BA4342C</b>	0.070	
 XB2BL****C	⊘		1	<b>XB2BL4322C</b>	0.070	
	STOP		1	<b>XB2BL4342C</b>	0.070	

## 锁扣式蘑菇头“紧急停止”按钮

说明		触点类型		型号	重量	尺寸
		常开	常闭			
 XB2BT(X)**C	Ø40		1	<b>XB2BT42C</b>	0.115	
	Ø60		1	<b>XB2BX42C</b>	0.120	
 XB2BS***C	Ø30		1	<b>XB2BS442C</b>	0.085	
	Ø40		1	<b>XB2BS542C</b>	0.095	
	Ø60		1	<b>XB2BS642C</b>	0.105	
 XB2BS***C	Ø30		1	<b>XB2BS742C</b>	0.130	
	Ø40		1	<b>XB2BS142C</b>	0.140	
	Ø60		1	<b>XB2BS242C</b>	0.160	

## 带有“触发动作”的锁扣式蘑菇头“紧急停止”按钮

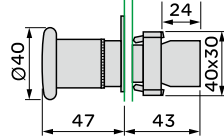
说明		触点类型		型号	重量	尺寸
		常开	常闭			
 XB2BS****C	Ø40	1	1	<b>XB2BS8445C</b>	0.115	
	Ø40	1	1	<b>XB2BS9445C</b>	0.135	





# XB2B

## 金属系列按钮



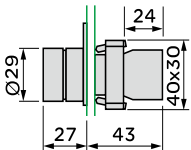

### Ø22 mm

## 选择开关

## 标准手柄

说明	位置	触点类型		型号	重量	尺寸	
		常开	常闭				
 XB2BD**C	2位		1		<b>XB2BD21C</b>	0.085	
			1	1	<b>XB2BD25C</b>	0.100	
			1		<b>XB2BD41C</b>	0.085	
			1	1	<b>XB2BD45C</b>	0.100	
	3位		2		<b>XB2BD33C</b>	0.100	
			2		<b>XB2BD53C</b>	0.100	
			2		<b>XB2BD73C</b>	0.100	
			2				

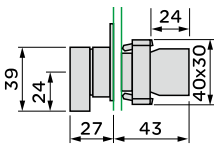
## 长手柄

说明	位置	触点类型		型号	重量	尺寸	
		常开	常闭				
 XB2BJ**C	2位		1		<b>XB2BJ21C</b>	0.085	
			1	1	<b>XB2BJ25C</b>	0.100	
			1		<b>XB2BJ41C</b>	0.085	
			1	1	<b>XB2BJ45C</b>	0.100	
	3位		2		<b>XB2BJ33C</b>	0.100	
			2		<b>XB2BJ53C</b>	0.100	
			2		<b>XB2BJ73C</b>	0.100	
			2				

标记说明:  锁定  弹簧返回

## 钥匙开关

说明	位置	触点类型		型号	重量	尺寸	
		常开	常闭				
 XB2BG**C	2位		1		<b>XB2BG21C</b>	0.110	
			1	1	<b>XB2BG25C</b>	0.125	
			1		<b>XB2BG41C</b>	0.110	
			1	1	<b>XB2BG45C</b>	0.125	
			1		<b>XB2BG61C</b>	0.110	
			1	1	<b>XB2BG65C</b>	0.125	
	3位		2		<b>XB2BG33C</b>	0.125	
			2		<b>XB2BG53C</b>	0.125	
			2		<b>XB2BG03C</b>	0.125	
			2		<b>XB2BG73C</b>	0.125	
			2				
			2				

标记说明:  锁定  弹簧返回  钥匙抽出

# XB2B

## 金属系列按钮

### Ø22 mm

## 带灯按钮



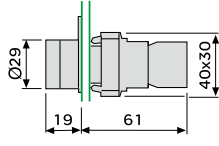





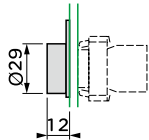

## 平头带灯按钮 (弹簧返回)

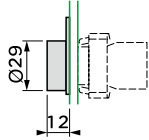
	电源电压	颜色	触点类型		型号	重量	尺寸
			常开	常闭			
 XB2BW***C	交直流24V	○	1		<b>XB2BW31B1C</b>	0.120	
	含LED灯泡	●	1		<b>XB2BW33B1C</b>	0.120	
		●	1		<b>XB2BW34B1C</b>	0.120	
		●	1		<b>XB2BW35B1C</b>	0.120	
		●	1		<b>XB2BW36B1C</b>	0.120	
	交流220V	○	1		<b>XB2BW31M1C</b>	0.120	
	含LED灯泡	●	1		<b>XB2BW33M1C</b>	0.120	
		●	1		<b>XB2BW34M1C</b>	0.120	
		●	1		<b>XB2BW35M1C</b>	0.120	
		●	1		<b>XB2BW36M1C</b>	0.120	

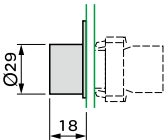
# XB2B 金属系列按钮 Ø22 mm

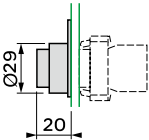
**按钮头**

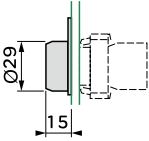

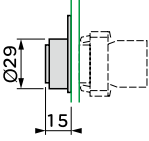



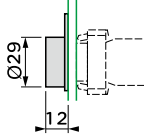

**弹簧复位按钮头**

	说明	颜色	型号	重量 (kg)	尺寸
 ZB2BA•C	平头按钮头	○	ZB2BA1C	0.030	
		●	ZB2BA2C	0.030	
		●	ZB2BA3C	0.030	
		●	ZB2BA4C	0.030	
		●	ZB2BA5C	0.030	
		●	ZB2BA6C	0.030	
 ZB2BA•8C	平头半透明式按钮头	●	ZB2BA38C	0.030	
		●	ZB2BA48C	0.030	
		●	ZB2BA58C	0.030	
		●	ZB2BA68C	0.030	
		透明	ZB2BA78C	0.030	
 ZB2BA•6C	带保护罩凹入式按钮头	○	ZB2BA16C	0.040	
		●	ZB2BA26C	0.040	
		●	ZB2BA36C	0.040	
		●	ZB2BA46C	0.040	
		●	ZB2BA56C	0.040	
		●	ZB2BA66C	0.040	
 ZB2BL•C	凸头按钮头	○	ZB2BL1C	0.030	
		●	ZB2BL2C	0.030	
		●	ZB2BL3C	0.030	
		●	ZB2BL4C	0.030	
		●	ZB2BL5C	0.030	
		●	ZB2BL6C	0.030	
 ZB2BP•C	带罩按钮头	●	ZB2BP2C	0.025	
		●	ZB2BP3C	0.025	
		●	ZB2BP4C	0.025	
		●	ZB2BP5C	0.025	
		●	ZB2BP6C	0.025	
		●	ZB2BP6C	0.025	
 ZB2BP•8C	半透明罩按钮头	●	ZB2BP38C	0.030	
		●	ZB2BP48C	0.030	
		●	ZB2BP58C	0.030	
		●	ZB2BP68C	0.030	
		透明	ZB2BP78C	0.030	

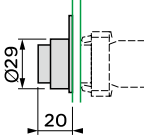
# XB2B 金属系列按钮 Ø22 mm

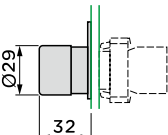
## 按钮头

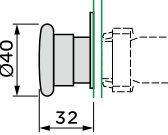

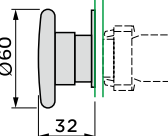



### 弹簧复位按钮头

	说明	标记 颜色	型号	重量 (kg)	尺寸
 ZB2BA***C	带功能符号平头按钮头	ⓘ	ZB2BA131C	0.030	
		Ⓜ	ZB2BA331C	0.030	
		Ⓜ	ZB2BA136C	0.030	
		Ⓜ	ZB2BA336C	0.030	
		Ⓜ	ZB2BA334C	0.030	
		Ⓜ	ZB2BA335C	0.030	
		Ⓜ	ZB2BA232C	0.030	
		Ⓜ	ZB2BA432C	0.030	
		STOP	ZB2BA234C	0.030	
		STOP	ZB2BA434C	0.030	
 ZB2BL***C	带功能符号凸头按钮头	Ⓜ	ZB2BL232C	0.030	
		Ⓜ	ZB2BL432C	0.030	
		STOP	ZB2BL234C	0.030	
		STOP	ZB2BL434C	0.030	
 ZB2BC*4C	蘑菇头按钮头 Ø30 mm	●	ZB2BC24C	0.045	
		●	ZB2BC34C	0.045	
		●	ZB2BC44C	0.045	
		●	ZB2BC54C	0.045	
		●	ZB2BC64C	0.045	
 ZB2BC*C	蘑菇头按钮头 Ø40 mm	●	ZB2BC2C	0.045	
		●	ZB2BC3C	0.045	
		●	ZB2BC4C	0.045	
		●	ZB2BC5C	0.045	
		●	ZB2BC6C	0.045	
 ZB2BR*C	蘑菇头按钮头 Ø60 mm	●	ZB2BR2C	0.055	
		●	ZB2BR3C	0.055	
		●	ZB2BR4C	0.055	
		●	ZB2BR5C	0.055	
		●	ZB2BR6C	0.055	

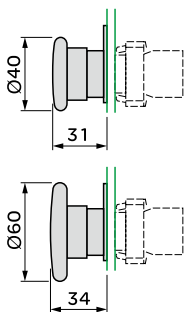
# XB2B 金属系列按钮 Ø22 mm

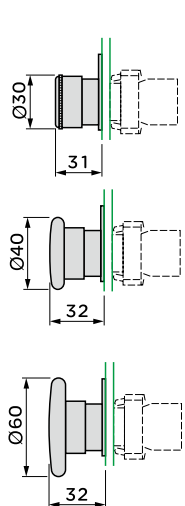
**按钮头**

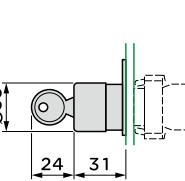
**锁定式急停按钮头**

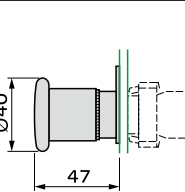
	说明	颜色	型号	重量 (kg)	尺寸	
 ZB2BT(X)•C	蘑菇头按钮头 拉拔复位	Ø40 mm	●	ZB2BT2C	0.075	
			●	ZB2BT3C	0.075	
			●	ZB2BT4C	0.075	
			●	ZB2BT5C	0.075	
			●	ZB2BT6C	0.075	
		Ø60 mm	●	ZB2BX2C	0.080	
	●	ZB2BX4C	0.080			
 ZB2BS••C	蘑菇头按钮头 转动复位	Ø30 mm	●	ZB2BS42C	0.045	
			●	ZB2BS43C	0.045	
			●	ZB2BS44C	0.045	
			●	ZB2BS45C	0.045	
			●	ZB2BS46C	0.045	
		Ø40 mm	●	ZB2BS52C	0.055	
			●	ZB2BS54C	0.055	
			●	ZB2BS55C	0.055	
		Ø60 mm	●	ZB2BS62C	0.065	
	●	ZB2BS64C	0.065			
 ZB2BS•••C	蘑菇头按钮头 钥匙复位	Ø30 mm	●	ZB2BS72C	0.090	
			●	ZB2BS74C	0.090	
		Ø40 mm	●	ZB2BS12C	0.090	
			●	ZB2BS14C	0.090	
		Ø60 mm	●	ZB2BS22C	0.120	
			●	ZB2BS24C	0.120	
 ZB2BS••••C	带触发动作的 蘑菇头按钮头 转动复位	Ø30 mm	●	ZB2BS834C	0.060	
		Ø40 mm	●	ZB2BS844C	0.060	
	带触发动作的 蘑菇头按钮头 钥匙复位	Ø30 mm	●	ZB2BS934C	0.080	
		Ø40 mm	●	ZB2BS944C	0.080	
		Ø60 mm	●	ZB2BS964C	0.110	
			●			

# XB2B 金属系列按钮 Ø22 mm

## 选择开关头

### 标准手柄选择开关头

	说明	位置	型号	重量 (kg)	尺寸
 <b>ZB2BD-C</b>	2位	∨	<b>ZB2BD2C</b>	0.045	
		◊	<b>ZB2BD4C</b>	0.045	
	3位	∨	<b>ZB2BD3C</b>	0.045	
		◊	<b>ZB2BD5C</b>	0.045	
		∨	<b>ZB2BD7C</b>	0.045	
∨	<b>ZB2BD8C</b>	0.045			

### 长手柄选择开关头

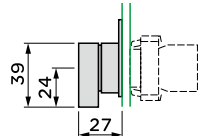
	说明	位置	型号	重量 (kg)	尺寸
 <b>ZB2BJ-C</b>	2位	∨	<b>ZB2BJ2C</b>	0.045	
		◊	<b>ZB2BJ4C</b>	0.045	
	3位	∨	<b>ZB2BJ3C</b>	0.045	
		◊	<b>ZB2BJ5C</b>	0.045	
		∨	<b>ZB2BJ7C</b>	0.045	
∨	<b>ZB2BJ8C</b>	0.045			

## 钥匙开关头











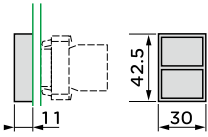

### 钥匙开关头

	说明	位置	型号	重量 (kg)	尺寸
 <b>ZB2BG-C</b>	2位	∨	<b>ZB2BG2C</b>	0.070	
		∨	<b>ZB2BG4C</b>	0.070	
		◊	<b>ZB2BG6C</b>	0.070	
	3位	∨	<b>ZB2BG3C</b>	0.070	
		∨	<b>ZB2BG5C</b>	0.070	
		∨	<b>ZB2BG9C</b>	0.070	
		∨	<b>ZB2BG09C</b>	0.070	
		∨	<b>ZB2BG0C</b>	0.070	
		◊	<b>ZB2BG7C</b>	0.070	
		◊	<b>ZB2BG1C</b>	0.070	
∨	<b>ZB2BG8C</b>	0.070			

标记说明: ∨ 锁定    ◊ 弹簧返回    钥匙抽出

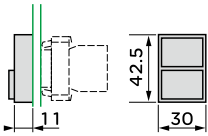



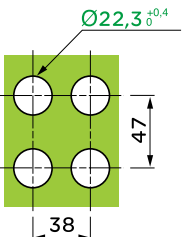





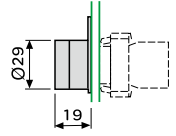

### 双头按钮头

#### 弹簧复位

	说明	标记 颜色	型号	重量 (kg)	尺寸
 <b>ZB2BA****</b>	2平头		<b>ZB2BA9124</b>	0.050	
			<b>ZB2BA9134</b>	0.050	
			<b>ZB2BA9224</b>	0.050	
			<b>ZB2BA9234</b>	0.050	
 <b>ZB2BL****</b>	1平头, 1凸头		<b>ZB2BL9324</b>	0.050	
			<b>ZB2BL9334</b>	0.050	
			<b>ZB2BL9424</b>	0.050	
			<b>ZB2BL9434</b>	0.050	
	安装开孔图 (厚度: 1-6 mm)				

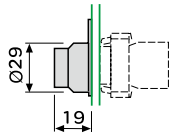

### 带灯按钮头

#### 弹簧复位

	说明	标记 颜色	型号	重量 (kg)	尺寸
 <b>ZB2BW3•C</b>	平头带灯按钮头		<b>ZB2BW31C</b>	0.030	
			<b>ZB2BW33C</b>	0.030	
			<b>ZB2BW34C</b>	0.030	
			<b>ZB2BW35C</b>	0.030	
			<b>ZB2BW36C</b>	0.030	
		透明	<b>ZB2BW37C</b>	0.030	
 <b>ZB2BW1•C</b>	凸头带灯按钮头		<b>ZB2BW11C</b>	0.030	
			<b>ZB2BW13C</b>	0.030	
			<b>ZB2BW14C</b>	0.030	
			<b>ZB2BW15C</b>	0.030	
			<b>ZB2BW16C</b>	0.030	

# XB2B 金属系列按钮 Ø22 mm

## 带灯选择开关头

		说明	位置	颜色	型号	重量 (kg)	尺寸
 ZB2BK1••	2位		●	ZB2BK123	0.045		
			●	ZB2BK124	0.045		
			●	ZB2BK125	0.045		
			●	ZB2BK126	0.045		
			透明	ZB2BK127	0.045		
			●	ZB2BK143	0.045		
			●	ZB2BK144	0.045		
	3位		●	ZB2BK145	0.045		
			●	ZB2BK146	0.045		
			透明	ZB2BK147	0.045		
			●	ZB2BK133	0.045		
			●	ZB2BK134	0.045		
			●	ZB2BK135	0.045		
			●	ZB2BK136	0.045		
			透明	ZB2BK137	0.045		
			●	ZB2BK153	0.045		
			●	ZB2BK154	0.045		
	●	ZB2BK155	0.045				
	●	ZB2BK156	0.045				
	透明	ZB2BK157	0.045				
	●	ZB2BK173	0.045				
	●	ZB2BK174	0.045				
	●	ZB2BK175	0.045				
	●	ZB2BK176	0.045				
	透明	ZB2BK177	0.045				

标记说明:  锁定  弹簧返回

## 带灯蘑菇头按钮头

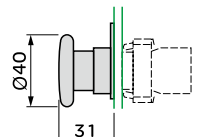
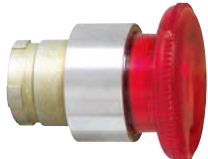

		说明	颜色	型号	重量 (kg)	尺寸
 ZB2BW4•	弹簧返回	Ø40 mm	●	ZB2BW43	0.055	
			●	ZB2BW44	0.055	
			●	ZB2BW45	0.055	
			●	ZB2BW46	0.055	
			透明	ZB2BW47	0.055	
 ZB2BW6•	锁定式 拉拔复位	Ø40 mm	●	ZB2BW63	0.055	
			●	ZB2BW64	0.055	
			●	ZB2BW65	0.055	
			●	ZB2BW66	0.055	
			透明	ZB2BW67	0.055	



# XB2B 金属系列按钮 Ø22 mm

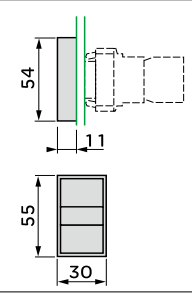

## 带指示灯双头按钮头

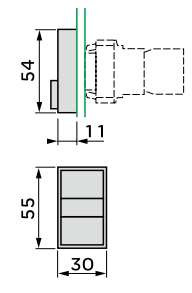
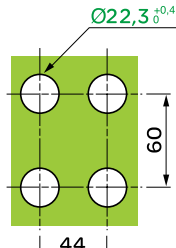
### 弹簧复位

	说明	颜色	型号	重量 (kg)	尺寸
 <b>ZB2BW8***</b>	2平头 中间指示灯		<b>ZB2BW81254</b>	0.060	
			<b>ZB2BW81354</b>	0.060	
			<b>ZB2BW82254</b>	0.060	
			<b>ZB2BW82354</b>	0.060	
 <b>ZB2BW8***</b>	1平头 中间指示灯 1凸头		<b>ZB2BW83254</b>	0.060	
			<b>ZB2BW83354</b>	0.060	
			<b>ZB2BW84254</b>	0.060	
			<b>ZB2BW84354</b>	0.060	
	安装开孔图 (厚度: 1-6 mm)				

## 带灯按钮基座

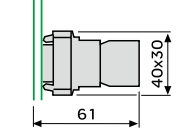
### 带灯按钮基座

	说明	颜色	触点类型	型号	重量 (kg)	尺寸
			常开      常闭			
 <b>ZB2BW***C</b>	交直流24V 含LED灯泡		1	<b>ZB2BWB11C</b>	0.090	
			1	<b>ZB2BWB31C</b>	0.090	
			1	<b>ZB2BWB32C</b>	0.090	
			1	<b>ZB2BWB41C</b>	0.090	
			1	<b>ZB2BWB42C</b>	0.090	
			1	<b>ZB2BWB51C</b>	0.090	
			1	<b>ZB2BWB61C</b>	0.090	
			1	<b>ZB2BWM11C</b>	0.090	
			1	<b>ZB2BWM31C</b>	0.090	
			1	<b>ZB2BWM32C</b>	0.090	
 <b>ZB2BW06*C</b>	直接电源 不含LED (BA 9s灯座) <380V 50 Hz		1	<b>ZB2BW061C</b>	0.090	
			1	<b>ZB2BW062C</b>	0.090	
			2	<b>ZB2BW063C</b>	0.090	
			2	<b>ZB2BW064C</b>	0.090	
			1	<b>ZB2BW065C</b>	0.090	

# XB2B 金属系列按钮 Ø22 mm

## 触点基座

### 触点基座

说明	触点类型		型号	重量 (kg)	尺寸	
	常开	常闭				
 <p><b>ZB2BZ10•C</b></p> <p>带触点模块的基座，应用于客户的各种设计用途</p>	1		<b>ZB2BZ101C</b>	0.040		
		1	<b>ZB2BZ102C</b>	0.040		
	2		<b>ZB2BZ103C</b>	0.055		
		2	<b>ZB2BZ104C</b>	0.055		
		1	1	<b>ZB2BZ105C</b>		0.055
	先通后断	1	1	<b>ZB2BZ106C</b>		0.055
	先后接通	2		<b>ZB2BZ107C</b>		0.055

## 触点模块

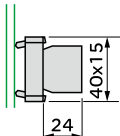
说明	触点类型		型号	重量 (kg)	尺寸
	常开	常闭			
 <p><b>ZB2BE10•C</b></p> <p>辅助/可替换的触点螺旋压入式端子</p>	1		<b>ZB2BE101C</b>	0.015	
		1	<b>ZB2BE102C</b>	0.015	

## 锁定模块

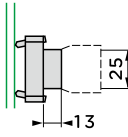
说明	型号	重量 (kg)	尺寸
 <p><b>ZB2BZ21C</b></p> <p>用于按钮(除“急停按钮”、选择、钥匙开关外)和带灯按钮安装于触点模块前面,实现按-锁定-按-释放</p>	<b>ZB2BZ21C</b>	0.015	

## 指示灯

## 通用型指示灯



XB2BV\*\*\*LC

电源电压	颜色	型号	重量 (kg)	尺寸	
交直流24V 含LED灯泡	○	XB2BVB1LC	0.020		
	●	XB2BVB3LC	0.020		
	●	XB2BVB4LC	0.020		
	●	XB2BVB5LC	0.020		
	●	XB2BVB6LC	0.020		
	交直流48V 含LED灯泡	○	XB2BVE1LC		0.020
●		XB2BVE3LC	0.020		
●		XB2BVE4LC	0.020		
●		XB2BVE5LC	0.020		
直流110V 含LED灯泡		○	XB2BVD1LC		0.020
		●	XB2BVD3LC		0.020
	●	XB2BVD4LC	0.020		
	●	XB2BVD5LC	0.020		
	●	XB2BVD6LC	0.020		
	交流110V 含LED灯泡	○	XB2BVF1LC		0.020
●		XB2BVF3LC	0.020		
●		XB2BVF4LC	0.020		
●		XB2BVF5LC	0.020		
●		XB2BVF6LC	0.020		
直流220V 含LED灯泡		○	XB2BVM1LC		0.020
	●	XB2BVM3LC	0.020		
	●	XB2BVM4LC	0.020		
	●	XB2BVM5LC	0.020		
	●	XB2BVM6LC	0.020		
	交流220V 含LED灯泡	○	XB2BVM1LC	0.020	
●		XB2BVM3LC	0.020		
●		XB2BVM4LC	0.020		
●		XB2BVM5LC	0.020		
●		XB2BVM6LC	0.020		
交流380V 含LED灯泡		○	XB2BVQ1LC	0.020	
	●	XB2BVQ3LC	0.020		
	●	XB2BVQ4LC	0.020		
	●	XB2BVQ5LC	0.020		
	●	XB2BVQ6LC	0.020		

## 蜂鸣器



XB2BS\*C

说明	电源电压	颜色	型号	重量 (kg)
持续声音 100 dB / 10 cm	交直流24V		XB2BSBC	0.017
	交流110V		XB2BSFC	0.017
	交流220V		XB2SMC	0.017

# XB5A

## 塑料系列模块式按钮

### Ø22 mm

#### 特性

##### 环境

符合标准	IEC 60947-5-1, EN 60 947-5-1, GB 14048.1, GB 14048.5
防护处理	“TH”
环境温度	工作温度: -25 ~ +70 °C, 贮存温度: -40 ~ +70 °C
抗振性	5 gn (2-500Hz), 符合IEC 60068-2-6
电子冲击保护	II级, 符合 IEC 536
防护等级	IP65: 平头按钮, 带或不带指示灯
符合 IEC 529	
机械寿命	弹簧复位式按钮: 500万次, 选择开关: 100万次, 急停按钮: 30万次

##### 触点特性

额定工作特性	~ AC-15: A600 或 Ue = 240 V 和 Ie = 3 A --- DC-13: Q600 或 Ue = 250 V 和 Ie = 0.27 A 符合 IEC 947-5-1附录 A
额定绝缘电压	Ui = 600 V, 污染等级 3, 符合 IEC 60947-1, Ui = 600 V
额定耐冲击电压	Uimp = 6 kV 符合 IEC 947-1
触头动作	慢断 (常闭或常开)
可靠工作	安全装置 (蘑菇头 “急停” 按钮): 常闭触点分断可靠, 符合 IEC 60947-5-1第3部分

操作压力	平头按钮 - 带1常开触点: 3.8 N - 带1常闭触点: 3.5 N 辅助触点 - 常开: + 2.3 N - 常闭: + 2 N
------	--

端子型号	符合 EN 50013和EN 50005
------	----------------------

短路保护	10 A 符合 IEC/EN 60947-5-1, 其中熔断器符合 IEC 60269-1
------	---

额定工作功率	符合 IEC 60947-5-1附录 C。应用范围 AC-15 和 DC-13。 操作频率: 3600 次操作/小时。 负载因数: 0.5
--------	---

交流电源 ~ 50-60 Hz ~ 感性电路 操作—百万次	直流电源 --- 操作—百万次														
<table style="width: 100%; border-collapse: collapse;"> <tr> <td style="width: 10%; text-align: left;">V</td> <td style="width: 15%; text-align: center;">24</td> <td style="width: 15%; text-align: center;">120</td> <td style="width: 15%; text-align: center;">230</td> </tr> <tr> <td style="text-align: left;">A</td> <td style="text-align: center;">4</td> <td style="text-align: center;">3</td> <td style="text-align: center;">2</td> </tr> </table>	V	24	120	230	A	4	3	2	<table style="width: 100%; border-collapse: collapse;"> <tr> <td style="width: 10%; text-align: left;">V</td> <td style="width: 15%; text-align: center;">24</td> <td style="width: 15%; text-align: center;">110</td> </tr> <tr> <td style="text-align: left;">A</td> <td style="text-align: center;">0.5</td> <td style="text-align: center;">0.2</td> </tr> </table>	V	24	110	A	0.5	0.2
V	24	120	230												
A	4	3	2												
V	24	110													
A	0.5	0.2													

可靠性能	—亿次操作中, 故障率 < 1 (可编程控制器输入, 24 V d.c.)
------	---------------------------------------

接线	—螺旋压入式端子, 接线能力: 最小 1 × 0.22 mm <sup>2</sup> , 不带接线端片 最大 2 × 1.5 mm <sup>2</sup> , 带接线端片
----	--

# XB5A 塑料系列按钮

Ø22 mm

型号说明

模块型号  
ZB5A...C

完整型号  
XB5A...C

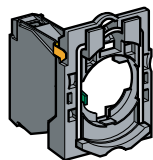

触点基座

按钮头

按钮

辅助触点的连接：最多可加至9付触点模块。

产品供货说明：

XB5A系列产品以分体模块形式供货，模块型号为ZB5A...C。

组成和附件

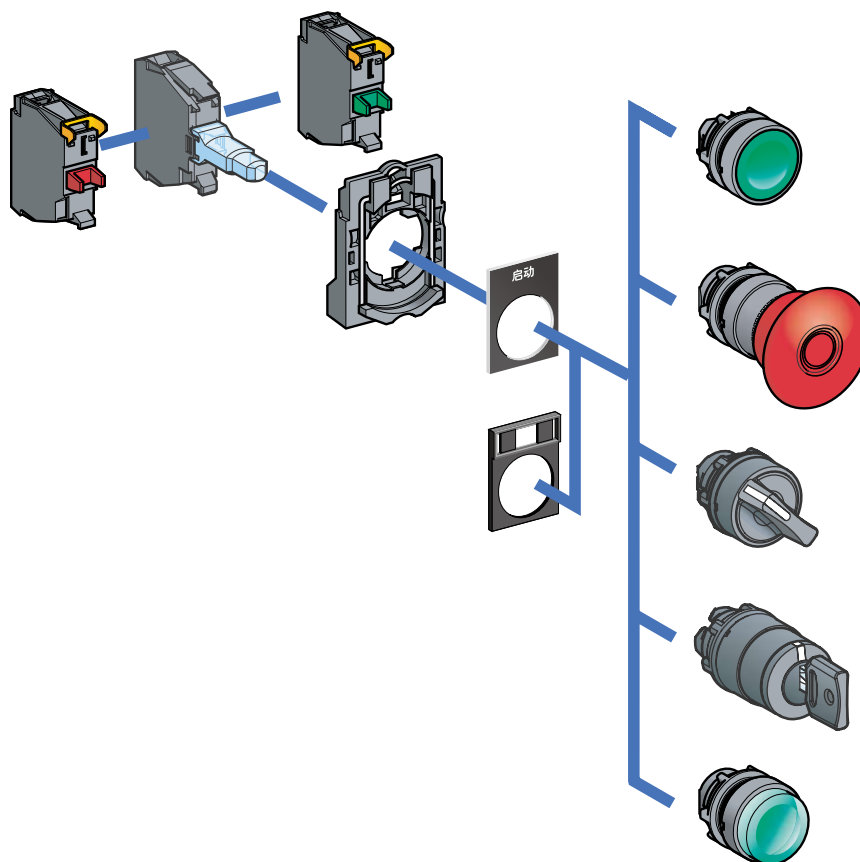

# XB5A

## 塑料系列模块式按钮

### Ø22 mm

## 按钮

说明		触点类型		型号	重量	尺寸
		常开	常闭			
 XB5AA**C	平头按钮 (弹簧返回)	○	1	<b>XB5AA11C</b> (ZB5AA1C+ZB5AZ101C)	0.070	
		●	1	<b>XB5AA21C</b> (ZB5AA2C+ZB5AZ101C)	0.070	
		●	1	<b>XB5AA31C</b> (ZB5AA3C+ZB5AZ101C)	0.070	
		●	1	<b>XB5AA42C</b> (ZB5AA4C+ZB5AZ102C)	0.070	
		●	1	<b>XB5AA51C</b> (ZB5AA5C+ZB5AZ101C)	0.070	
		●	1	<b>XB5AA61C</b> (ZB5AA6C+ZB5AZ101C)	0.070	

## 急停按钮

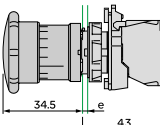
说明		触点类型		型号	重量	尺寸
		常开	常闭			
 XB5AS542C	Ø40 mm红色蘑菇头 转动复位		1	<b>XB5AS542C</b> (ZB5AS54C+ZB5AZ102C)	0.070	

## 选择开关

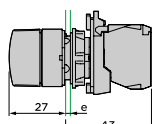
说明		触点类型		型号	重量	尺寸
		常开	常闭			
 XB5AD**C	2位锁定	∨	1	<b>XB5AD21C</b> (ZB5AD2C+ZB5AZ101C)	0.040	
	3位锁定	∨	2	<b>XB5AD33C</b> (ZB5AD3C+ZB5AZ103C)	0.055	

## 钥匙开关

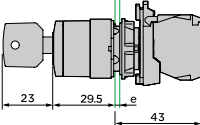
说明		触点类型		型号	重量	尺寸
		常开	常闭			
 XB5AG**C	2位锁定 左侧钥匙抽出	∨	1	<b>XB5AG21C</b> (ZB5AG2C+ZB5AZ101C)	0.065	
	3位锁定 中间钥匙抽出	∨	2	<b>XB5AG33C</b> (ZB5AG3C+ZB5AZ103C)	0.080	

标记说明: ∨ 锁定    ∩ 弹簧返回    ⚙ 钥匙抽出

# XB5A

## 塑料系列模块式按钮

### Ø22 mm

## 带灯按钮

## 平头带灯按钮 (弹簧返回)



XB5A\*\*\*\*C

电源电压	颜色	触点类型		型号	重量	尺寸
		常开	常闭			
交直流24V 含LED灯泡		1		<b>XB5AW31B1C</b> (ZB5AW313C+ZB5AW0B11C)	0.055	
		1		<b>XB5AW33B1C</b> (ZB5AW333C+ZB5AW0B31C)	0.055	
		1		<b>XB5AW34B1C</b> (ZB5AW343C+ZB5AW0B41C)	0.055	
			1	<b>XB5AW34B2C</b> (ZB5AW343C+ZB5AW0B42C)	0.055	
		1		<b>XB5AW35B1C</b> (ZB5AW353C+ZB5AW0B51C)	0.055	
		1		<b>XB5AW36B1C</b> (ZB5AW363C+ZB5AW0B61C)	0.055	
交流110V 含LED灯泡		1		<b>XB5AW31G1C</b> (ZB5AW313C+ZB5AW0G11C)	0.055	
		1		<b>XB5AW33G1C</b> (ZB5AW333C+ZB5AW0G31C)	0.055	
		1		<b>XB5AW34G1C</b> (ZB5AW343C+ZB5AW0G41C)	0.055	
			1	<b>XB5AW34G2C</b> (ZB5AW343C+ZB5AW0G42C)	0.055	
		1		<b>XB5AW35G1C</b> (ZB5AW353C+ZB5AW0G51C)	0.055	
		1		<b>XB5AW36G1C</b> (ZB5AW363C+ZB5AW0G61C)	0.055	
交流220V 含LED灯泡		1		<b>XB5AW31M1C</b> (ZB5AW313C+ZB5AW0M11C)	0.055	
		1		<b>XB5AW33M1C</b> (ZB5AW333C+ZB5AW0M31C)	0.055	
		1		<b>XB5AW34M1C</b> (ZB5AW343C+ZB5AW0M41C)	0.055	
			1	<b>XB5AW34M2C</b> (ZB5AW343C+ZB5AW0M42C)	0.055	
		1		<b>XB5AW35M1C</b> (ZB5AW353C+ZB5AW0M51C)	0.055	
		1		<b>XB5AW36M1C</b> (ZB5AW363C+ZB5AW0M61C)	0.055	
交流380V 含LED灯泡		1		<b>XB5AW31Q1C</b> (ZB5AW313C+ZB5AW0Q11C)	0.055	
		1		<b>XB5AW33Q1C</b> (ZB5AW333C+ZB5AW0Q31C)	0.055	
		1		<b>XB5AW34Q1C</b> (ZB5AW343C+ZB5AW0Q41C)	0.055	
			1	<b>XB5AW34Q2C</b> (ZB5AW343C+ZB5AW0Q42C)	0.055	
		1		<b>XB5AW35Q1C</b> (ZB5AW353C+ZB5AW0Q51C)	0.055	
		1		<b>XB5AW36Q1C</b> (ZB5AW363C+ZB5AW0Q61C)	0.055	

### 按钮头

#### 弹簧复位按钮头

说明	颜色	型号	重量 (kg)	
 ZB5AA•C	平头按钮头	○	ZB5AA1C	0.015
		●	ZB5AA2C	0.015
		●	ZB5AA3C	0.015
		●	ZB5AA4C	0.015
		●	ZB5AA5C	0.015
		●	ZB5AA6C	0.015

#### 选择开关头

说明	位置	型号	重量 (kg)	
 ZB5AD•C	2位锁定	∨	ZB5AD2C	0.020
	3位锁定	∨	ZB5AD3C	0.020

#### 钥匙开关头

说明	位置	型号	重量 (kg)	
 ZB5AG•C	2位锁定 左侧钥匙抽出	∨	ZB5AG2C	0.045
	3位锁定 中间钥匙抽出	∨	ZB5AG3C	0.045

标记说明: ∨ 锁定      ⚙ 钥匙抽出

#### 锁定式急停按钮头

说明	颜色	型号	重量 (kg)	
 ZB5AS54C	蘑菇头按钮头 转动复位	●	ZB5AS54C	0.050

#### 弹簧复位带灯按钮头

说明	颜色	型号	重量 (kg)	
 ZB5AW3••C	平头按钮头	○	ZB5AW313C	0.015
		●	ZB5AW333C	0.015
		●	ZB5AW343C	0.015
		●	ZB5AW353C	0.015
		●	ZB5AW363C	0.015



# XB5A

## 塑料系列模块式按钮

Ø22 mm

### 触点基座

#### 触点基座

	说明	触点类型		型号	重量		
		常开	常闭				
 <p><b>ZB5AZ10•C</b></p>	带触点模块的基座，应用于客户的各种设计用途	1		<b>ZB5AZ101C</b>	0.020		
			1		<b>ZB5AZ102C</b>	0.020	
				2		<b>ZB5AZ103C</b>	0.030
				2		<b>ZB5AZ104C</b>	0.030
				1	1	<b>ZB5AZ105C</b>	0.030

### 触点模块

	说明	触点类型		型号	重量
		常开	常闭		
 <p><b>ZBEE10•C</b></p>	辅助/可替换的触点螺旋压入式端子	1		<b>ZBEE101C</b>	0.015
				1	

# XB5A

## 塑料系列模块式按钮

Ø22 mm

带灯按钮基座

带灯按钮基座



ZB5AW0\*\*\*C

说明	颜色	触点类型		型号	重量
		常开	常闭		
交直流24V 含LED灯泡	○	1		ZB5AWOB11C	0.040
	●	1		ZB5AWOB31C	0.040
	●		1	ZB5AWOB32C	0.040
	●	1		ZB5AWOB41C	0.040
	●		1	ZB5AWOB42C	0.040
	●	1		ZB5AWOB51C	0.040
	●	1		ZB5AWOB61C	0.040
交流110V 含LED灯泡	○	1		ZB5AWOG11C	0.040
	●	1		ZB5AWOG31C	0.040
	●		1	ZB5AWOG32C	0.040
	●	1		ZB5AWOG41C	0.040
	●		1	ZB5AWOG42C	0.040
	●	1		ZB5AWOG51C	0.040
	●	1		ZB5AWOG61C	0.040
交流220V 含LED灯泡	○	1		ZB5AWOM11C	0.040
	●	1		ZB5AWOM31C	0.040
	●		1	ZB5AWOM32C	0.040
	●	1		ZB5AWOM41C	0.040
	●		1	ZB5AWOM42C	0.040
	●	1		ZB5AWOM51C	0.040
	●	1		ZB5AWOM61C	0.040
交流380V 含LED灯泡	○	1		ZB5AWOQ11C	0.040
	●	1		ZB5AWOQ31C	0.040
	●		1	ZB5AWOQ32C	0.040
	●	1		ZB5AWOQ41C	0.040
	●		1	ZB5AWOQ42C	0.040
	●	1		ZB5AWOQ51C	0.040
	●	1		ZB5AWOQ61C	0.040

## 特性

## 一体式按钮

符合标准	IEC 60947-5-1, GB14048.1, GB14048.5
防护处理	标准版本: “TC”
环境温度	工作: - 25 ~ +70 °C, 贮存: - 40 ~ +80°C
电子冲击保护	I级, 符合 IEC 536 和 NF C 20-030
防护等级	IP 40 (前部), 后部防指触设计
额定工作电流	0.3 A (AC240V), AC-14
额定绝缘电压	250 V
使用寿命	—百万次
接线	螺旋压入式端子 接线能力: 最小1×0.5 mm <sup>2</sup> , 最大2×1.5 mm <sup>2</sup> 或1×2.5 mm <sup>2</sup>

## 带有LED的指示灯

符合标准	IEC 60947-5-1, GB14048.1, GB14048.5
防护处理	标准版本: “TC”
环境温度	工作: - 25 ~ +70 °C, 贮存: - 40 ~ +80°C
电子冲击保护	I级, 符合 IEC 536 和 NF C 20-030
防护等级	IP 40 (前部), 后部防指触设计
功率损耗	24V 0.5W 220V 4.5W
额定绝缘电压	50 ~ 380 V 符合 IEC 947-1 依类型而定
使用寿命	标称电压下可超过50,000 小时
电压极限	$0.8U_n \leq U \leq 1.1U_n$
端子型号	X1, X2 符合 CENELEC EN 50013
接线	螺旋压入式端子 接线能力: 最小1×0.5 mm <sup>2</sup> , 最大2×1.5 mm <sup>2</sup> 或1×2.5 mm <sup>2</sup>

# XB7E

## 塑料系列一体式按钮

### Ø22 mm

## 一体式按钮

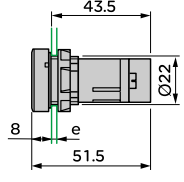
说明	颜色	触点类型			型号	重量	尺寸	
		常开	常闭	C/O				
 XB7EA**C	●	1			<b>XB7EA21C</b>	0.020		
		2			<b>XB7EA23C</b>	0.020		
				1		<b>XB7EA25C</b>		0.020
	●	1				<b>XB7EA31C</b>		0.020
		2				<b>XB7EA33C</b>		0.020
					1	<b>XB7EA35C</b>		0.020
	●				1	<b>XB7EA42C</b>		0.020
					1	<b>XB7EA45C</b>		0.020
	●				1	<b>XB7EA51C</b>		0.020

# XB7E

## 优化型指示灯

### Ø22 mm

## 指示灯

## 塑料系列指示灯



XB7E\*\*\*LC

说明	电源电压	颜色	型号	重量 (kg)	尺寸
含LED灯泡	交直流24V	○	XB7EVB1LC	0.017	
		●	XB7EVB3LC	0.017	
		●	XB7EVB4LC	0.017	
		●	XB7EVB5LC	0.017	
		●	XB7EVB6LC	0.017	
		○	XB7EVF1LC	0.017	
	交流110V	●	XB7EVF3LC	0.017	
		●	XB7EVF4LC	0.017	
		●	XB7EVF5LC	0.017	
		●	XB7EVF6LC	0.017	
		○	XB7EVFD1LC	0.017	
	直流110V	●	XB7EVFD3LC	0.017	
		●	XB7EVFD4LC	0.017	
		●	XB7EVFD5LC	0.017	
		●	XB7EVFD6LC	0.017	
		○	XB7EVM1LC	0.017	
	交流220V	●	XB7EVM3LC	0.017	
		●	XB7EVM4LC	0.017	
		●	XB7EVM5LC	0.017	
		●	XB7EVM6LC	0.017	
		○	XB7EVMD1LC	0.017	
直流220V	●	XB7EVMD3LC	0.017		
	●	XB7EVMD4LC	0.017		
	●	XB7EVMD5LC	0.017		
	●	XB7EVMD6LC	0.017		
	○	XB7EVQ1LC	0.017		
交流380V	●	XB7EVQ3LC	0.017		
	●	XB7EVQ4LC	0.017		
	●	XB7EVQ5LC	0.017		
	●	XB7EVQ6LC	0.017		

## 主令开关

说明	触点类型		型号	重量 (kg)	尺寸
	常开	常闭			
2位 	锁定	2	<b>XD2PA12CR</b>	0.115	
	弹簧返回	2	<b>XD2PA22CR</b>	0.115	
4位 	锁定	4	<b>XD2PA14CR</b>	0.145	
	弹簧返回	4	<b>XD2PA24CR</b>	0.145	

XD2PA\*\*CR

## 主令开关的安装开孔图

安装面板厚度: 1~6mm

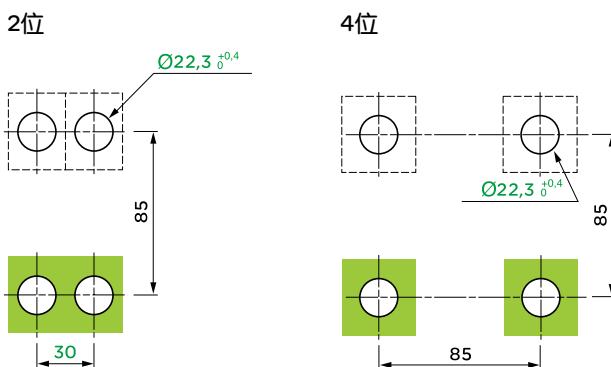

## 灯泡

说明	电源 电压	标记 颜色	型号	重量
				(kg)
 LED灯泡 BA 9s灯座	交直流 24V	○	<b>DL1-LED241</b>	0.002
		●	<b>DL1-LED243</b>	0.002
		●	<b>DL1-LED244</b>	0.002
		●	<b>DL1-LED245</b>	0.002
		●	<b>DL1-LED246</b>	0.002

DL1-LED\*\*\*

## 标签及标牌

## 环形刻度板(用于蘑菇头按钮)





说明	标记 颜色	型号	重量 (kg)	尺寸
 空白	白底或黄底	<b>ZB2BY9101C</b>	0.006	Ø60
		<b>ZB2BY8101</b>	0.008	Ø90
英文文字 "Emergency stop"	黄底黑字	<b>ZB2BY9330C</b>	0.006	Ø60
		<b>ZB2BY8330</b>	0.008	Ø90

ZB2BY\*\*\*\*

其它标签及标牌请与当地的区域办事处联系。

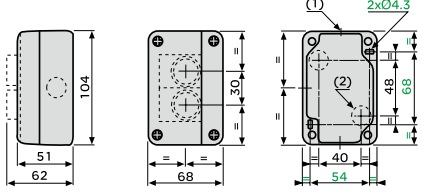
按钮盒

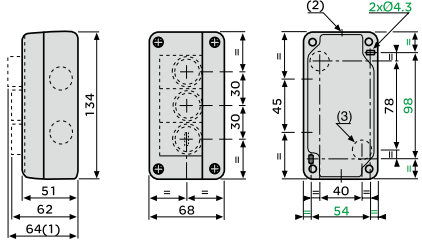
按钮盒

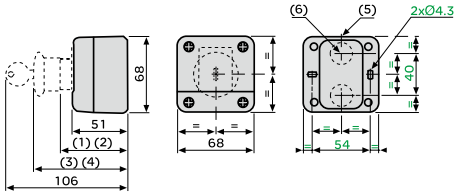
	说明	开孔 个数	型号	尺寸
 <p>XALBE01C</p>	底座和盒盖安装	1	XALBE01C	 <p>(1) 4 Ø 20mm 敲落孔, 最大线径 12mm (2) 2 Ø 19mm 敲落孔, 用于底部进线</p>
	适用于塑料系列按钮指示灯	2	XALBE02C	
	IP40	3	XALBE03C	
	不含按钮			
 <p>XALB01C</p>	底座和盒盖安装	1	XALB01C	 <p>(1) 指示灯 (2) 6 Ø 20mm 敲落孔, 最大线径 12mm (3) 2 Ø 19mm 敲落孔, 用于底部进线</p>
	适用于金属系列按钮指示灯	2	XALB02C	
	IP65	3	XALB03C	
	不含按钮 安装1个金属按钮+1个指示灯	2	XALB021C	
	安装2个金属按钮+1个指示灯	3	XALB031C	
 <p>XALB01YC</p>	急停按钮盒 不含急停按钮	1	XALB01YC	 <p>(1) 62mm 带按钮 (2) 77mm 带选择开关 (3) 82mm 带蘑菇头按钮 (4) 102mm 带可触发动作的蘑菇头按钮 (5) 2 Ø 20mm 敲落孔, 最大线径 12mm (6) 2 Ø 19mm 敲落孔, 用于底部进线</p>
	IP65 含急停按钮	1	XALJ01C	

孔塞

	说明	型号	重量 (kg)
 <p>ZB2SZ3</p>	Ø22黑色孔塞	ZB2SZ3	0.020

标签及标牌

8x27mm 嵌入式标签 (与ZB2BZ32配合使用)

颜色和文字	型号	颜色和文字	型号	尺寸
 START	ZBY02303C	 STOP	ZBY02304C	
 ON	ZBY02311C	 EMERGENCY STOP	ZBY02330C	
 OFF	ZBY02312C	 STOP	ZBY04304C	
 O	ZBY02146C	 EMERGENCY STOP	ZBY04330C	
 I	ZBY02147C	 停止	ZBY0C2304C	
 II	ZBY02148C	 紧急停止	ZBY0C2330C	
 OFF-ON	ZBY02367C	 停止	ZBY0C4304C	
 STOP-START	ZBY02366C	 紧急停止	ZBY0C4330C	

18x27mm 嵌入式标签 (与ZB2BZ33配合使用)

颜色和文字	型号	颜色和文字	型号	尺寸
 RESET	ZBY502303C	 STOP	ZBY502304C	
 ON	ZBY502311C	 EMERGENCY STOP	ZBY502330C	
 OFF	ZBY502312C	 STOP	ZBY504304C	
 O	ZBY502146C	 EMERGENCY STOP	ZBY504330C	
 I	ZBY502147C	 停止	ZBY50C2304C	
 II	ZBY502148C	 紧急停止	ZBY50C2330C	
 OFF-ON	ZBY502367C	 停止	ZBY50C4304C	
 STOP-START	ZBY502366C	 紧急停止	ZBY50C4330C	

30x40mm 一体式标牌

颜色和文字	型号	颜色和文字	型号	尺寸
 启动	ZB2BY2303C	 STOP	ZB2BY2304C	
 ON	ZB2BY2311C	 EMERGENCY STOP	ZB2BY2330C	
 OFF	ZB2BY2312C	 STOP	ZB2BY4304C	
 O	ZB2BY2146C	 EMERGENCY STOP	ZB2BY4330C	
 I	ZB2BY2147C	 停止	ZB2BYC2304C	
 II	ZB2BY2148C	 紧急停止	ZB2BYC2330C	
 OFF-ON	ZB2BY2367C	 停止	ZB2BYC4304C	
 STOP-START	ZB2BY2366C	 紧急停止	ZB2BYC4330C	

30x50mm 一体式标牌

颜色和文字	型号	颜色和文字	型号	尺寸
 停止	ZB2BY52303C	 STOP	ZB2BY52304C	
 ON	ZB2BY52311C	 EMERGENCY STOP	ZB2BY52330C	
 OFF	ZB2BY52312C	 STOP	ZB2BY54304C	
 O	ZB2BY02146C	 EMERGENCY STOP	ZB2BY54330C	
 I	ZB2BY02147C	 停止	ZB2BYC52304C	
 II	ZB2BY02148C	 紧急停止	ZB2BYC52330C	
 OFF-ON	ZB2BY02367C	 停止	ZB2BYC54304C	
 STOP-START	ZB2BY02366C	 紧急停止	ZB2BYC54330C	



## 标签及标牌

## 30x40mm 一体式标牌 (底部半圆)

	颜色和文字	型号	颜色和文字	型号	尺寸
 ZB2BYCR****C	空白(白底或黄底)	ZB2BYR4101C	空白(黑底或红底)	ZB2BYR2101C	
	启动	ZB2BYCR2303C	向后	ZB2BYCR2306C	
	电源	ZB2BYCR2326C	向右	ZB2BYCR2309C	
	开	ZB2BYCR2311C	向上	ZB2BYCR2307C	
	关	ZB2BYCR2312C	自动-手动	ZB2BYCR2364C	
	复位	ZB2BYCR0323C	自动-O-手动	ZB2BYCR2385C	
	运行	ZB2BYCR2334C	手动-关-自动	ZB2BYCR2387C	
	打开	ZB2BYCR2313C	关-开	ZB2BYCR2367C	
	关闭	ZB2BYCR2314C	停止-启动	ZB2BYCR2366C	
	向下	ZB2BYCR2308C	复位	ZB2BYCR2323C	
	向前	ZB2BYCR2305C	停止	ZB2BYCR2304C	
	手动	ZB2BYCR2316C	紧急停止	ZB2BYCR2330C	
	向左	ZB2BYCR2310C	停止	ZB2BYCR4304C	
			紧急停止	ZB2BYCR4330C	

标签标牌订货说明: 以上所有标签标牌均以10个为起订量。

## “嵌入式”刻度板底座

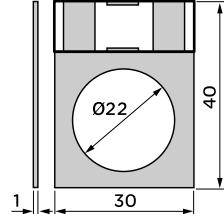
	说明	型号	重量 (kg)	尺寸
	30x40mm 用于8x27mm标签	ZB2BZ32	0.001	
	30x50mm 用于18x27mm标签	ZB2BZ33	0.001	

## 主令开关标签

	说明	标记 颜色	型号	尺寸
	配合XD2系列 主令开关使用	白色或黄色	ZD2GY2401C	30x48
		黑色或红色	ZD2GY2201C	30x48
	空白标签	白色或黄色	ZD2GY4401C	48x48
		黑色或红色	ZD2GY4201C	48x48





## 施耐德电气(中国)投资有限公司

<b>施耐德电气(中国)投资有限公司</b>	北京市朝阳区将台路2号和乔丽晶中心施耐德电气大厦	邮编: 100016	电话: (010) 84346699	传真: (010) 84501130
■ 上海分公司	上海市漕河泾开发区宜山路1009号创新大厦201室, 10-12, 15-16层	邮编: 200233	电话: (021) 24012500	传真: (021) 64957301
■ 广州分公司	广州市珠江新城临江大道3号发展中心大厦25层	邮编: 510623	电话: (020) 85185188	传真: (020) 85185195
■ 武汉分公司	武汉市汉口建设大道568号新世界国贸大厦1座37层01、02、03、05单元	邮编: 430022	电话: (027) 68850668	传真: (027) 68850488
■ 天津办事处	天津市河西区围堤道125号天信大厦22层2205-2207室	邮编: 300074	电话: (022) 28408408	传真: (022) 28408410
■ 天津分公司	天津市河东区十一经路78号万隆太平洋大厦1401-1404室	邮编: 300171	电话: (022) 84180888	传真: (022) 84180222
■ 济南办事处	济南市泺源大街229号金龙中心主楼21层D室	邮编: 250012	电话: (0531) 86121765	传真: (0531) 86121628
■ 青岛办事处	青岛香港中路59号国际金融中心35层3501B室	邮编: 266071	电话: (0532) 85793001	传真: (0532) 85793002
■ 石家庄办事处	石家庄市中山东路303号世贸皇冠酒店办公楼12层1201室	邮编: 050011	电话: (0311) 86698713	传真: (0311) 86698723
■ 沈阳办事处	沈阳沈河区青年大街219号华新国际大厦8层F/G/H/I座	邮编: 110016	电话: (024) 23964339	传真: (024) 23964296/4297
■ 哈尔滨办事处	哈尔滨南岗区红军街15号奥威斯发展大厦22层A、B座	邮编: 150001	电话: (0451) 53009797	传真: (0451) 53009639/9640
■ 长春办事处	长春解放大路 2677号长春光大银行大厦1211-12室	邮编: 130061	电话: (0431) 88400302/0303	传真: (0431) 88400301
■ 大连办事处	辽宁省大连市沙河口区五一一路267号17号楼201-1室	邮编: 116023	电话: (0411) 84769100	传真: (0411) 84769511
■ 西安办事处	西安高新区科技路48号创业广场B座17层1706室	邮编: 710075	电话: (029) 88332711	传真: (029) 88324697
■ 太原办事处	太原市府西街268号力鸿大厦B区1003室	邮编: 030002	电话: (0351) 4937186	传真: (0351) 4937029
■ 乌鲁木齐办事处	乌鲁木齐市新华北路5号美丽华酒店A座2521室	邮编: 830002	电话: (0991) 2825888 ext. 2521	传真: (0991) 2848188
■ 南京办事处	南京市中山路268号汇杰广场2001-2003室	邮编: 210008	电话: (025) 83198399	传真: (025) 83198321
■ 苏州办事处	苏州市工业园区苏华路2号国际大厦17层1711-1712单元	邮编: 215021	电话: (0512) 68622550	传真: (0512) 68622620
■ 无锡办事处	无锡市太湖广场永和路28号无锡工商综合大楼17层	邮编: 214021	电话: (0510) 81009780/61/62	传真: (0510) 81009760
■ 南通办事处	江苏省南通市跃龙路48号百乐门大酒店4001室	邮编: 226000	电话: (0513) 85586789	传真: (0513) 85586785
■ 常州办事处	常州市局前街2号常州椿庭楼宾馆1216室	邮编: 213000	电话: (0519) 88130710	传真: (0519) 88130711
■ 合肥办事处	合肥市长江东路1104号古井假日酒店820房间	邮编: 230011	电话: (0551) 4291993	传真: (0551) 2206956
■ 杭州办事处	杭州市凤起路78号浙金广场四层	邮编: 310003	电话: (0571) 85271466	传真: (0571) 85271305
■ 南昌办事处	江西南昌市八一大道357号财富广场A座2701室	邮编: 330046	电话: (0791) 6272972	传真: (0791) 6295323
■ 福州办事处	福州市仓山区建新镇闽江大道169号水乡温泉住宅区二期29楼102单元	邮编: 350000	电话: (0591) 87114853	传真: (0591) 87112046
■ 洛阳办事处	洛阳市涧西区凯旋西路88号华阳广场国际大饭店609室	邮编: 471003	电话: (0379) 65588678	传真: (0379) 65588679
■ 厦门办事处	厦门市思明区厦禾路189号银行中心2502-03A室	邮编: 361003	电话: (0592) 2386700	传真: (0592) 2386701
■ 宁波办事处	宁波市江东北路1号宁波中信国际大酒店833室	邮编: 315010	电话: (0574) 87706806	传真: (0574) 87717043
■ 温州办事处	温州市车站大道高联大厦写字楼9层B2号	邮编: 325000	电话: (0577) 86072225	传真: (0577) 86072228
■ 成都办事处	成都市顺城大街308号冠城广场27楼 A-F 座	邮编: 610017	电话: (028) 86528282	传真: (028) 86528383
■ 重庆办事处	重庆市渝中区邹容路68号重庆大都会商厦12楼11-12室	邮编: 400010	电话: (023) 63839700	传真: (023) 63839707
■ 佛山办事处	佛山市祖庙路33号百花广场26层2622-2623室	邮编: 528000	电话: (0757) 83990312/0029/1312	传真: (0757) 83992619
■ 昆明办事处	昆明市三市街6号柏联广场A座10层07-08单元	邮编: 650021	电话: (0871) 3647550	传真: (0871) 3647552
■ 长沙办事处	长沙市劳动西路215号湖南佳程酒店14层01、10-11单元	邮编: 410007	电话: (0731) 5112588	传真: (0731) 5159730
■ 郑州办事处	郑州市金水路115号中州皇冠假日酒店C座西翼二层	邮编: 450003	电话: (0371) 65939211	传真: (0371) 65939213
■ 中山办事处	中山市中山三路18号中银大厦18楼1813室	邮编: 528403	电话: (0760) 8235971	传真: (0760) 8235979
■ 鞍山办事处	鞍山市铁东区南胜利路21号万科写字楼2009室	邮编: 114001	电话: (0412) 5575511/5522	传真: (0412) 5573311
■ 烟台办事处	烟台市南大街9号金都大厦2514室	邮编: 264001	电话: (0535) 3393899	传真: (0535) 3393998
■ 南宁办事处	广西南宁市青秀区民族大道111号广西发展大厦10层	邮编: 530000	电话: (0771) 5519761/9762	传真: (0771) 5519760
■ 东莞办事处	东莞市南城区体育路2号鸿禧中心A406室	邮编: 523070	电话: (0769) 22413010	传真: (0769) 22413160
■ 深圳办事处	深圳市罗湖区深南东路5047号深圳发展银行大厦17层H-1室	邮编: 518001	电话: (0755) 25841022	传真: (0755) 82080250
■ 泰州办事处	江苏省泰州市江洲南路111号中丹宾馆328房间	邮编: 225300	电话: (0523) 86995328	传真: (0523) 86995326
■ 扬中办事处	扬中市前进北路52号扬中宾馆2018号房间	邮编: 212000	电话: (0511) 88398528	传真: (0511) 88398538
■ 贵阳办事处	贵阳市中华南路49号贵航大厦12层1204单元	邮编: 550002	电话: (0851) 5887006	传真: (0851) 5887009
■ 海口办事处	海南省海口市文华路18号海南文华大酒店6层607室	邮编: 570305	电话: (0898) 68597287	传真: (0898) 68597295
■ 施耐德(香港)有限公司	香港鲗鱼涌英皇道979号太古坊和域大厦13楼东翼		电话: (00852) 25650621	传真: (00852) 28111029
■ 施耐德电气中国研修学院	北京市朝阳区将台路2号和乔丽晶中心施耐德电气大厦	邮编: 100016	电话: (010) 84346699	传真: (010) 84501130

客户支持热线: 400 810 1315

## 客户支持热线：400 810 1315

施耐德电气中国  
Schneider Electric China  
[www.schneider-electric.cn](http://www.schneider-electric.cn)

北京市朝阳区将台路2号  
和乔丽晶中心施耐德电气大厦  
邮编: 100016  
电话: (010) 8434 6699  
传真: (010) 8450 1130

Schneider Electric Building, Chateau Regency,  
No.2 Jiangtai Road,Chaoyang District  
Beijing 100016, China  
Tel: (010) 8434 6699  
Fax: (010) 8450 1130

由于标准和材料的变更，文中所述特性和本资料中的图像只有经过我们的业务部门确认以后，才对我们有约束。



本手册采用生态纸印刷