

Ver 1.0



LRM 3500M

Laser Rangefinder Monocular

COMMUNICATION PROTOCOL

The LRF supports the NMEA 0183 interface. Physical connection is done with one universal connector Binder that supports connection to the USB port:

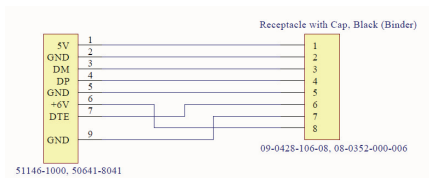

Fig. 1. Universal Port Pinout

Pin #	Description
Pin 1, (+5VDC)	USB power
Pin 2, (GND)	USB ground
Pin 3, (DM)	USB signal
Pin 4, (DP)	USB signal
Pin 5, (GND)	Ground
Pin 6, (DTE)	Device enable signal
Pin 7, (GND)	Power supply ground
Pin 8, (+6VDC)	Power supply positive terminal

NOTE: The connector may differ from the one described in the manual; this is subject to individual order.

The data is transmitted as ASCII code with fixed baud rate of 38400 bit/sec, 8 bits, one stop bit, and no parity.

1. Interface

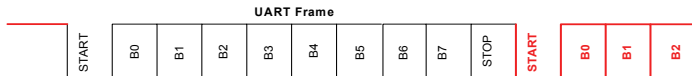

Figure 2. Data Frame

2. List of communication commands

PC command, ASCII (input command)	Description	Output command/data
\$CCSNQ, RCS *22<cr><lf>	Read Current Status	STATUS
\$CCSNQ, ACT *36<cr><lf>	Action measurement	RESULT
\$CCSNQ, DFL *2E<cr><lf>	set Default	STATUS
\$CCSNQ, WNS ,new status*cs<cr><lf>	Write New Status	STATUS
\$CCSNQ, REC *34<cr><lf>	Read Recall data	RESULT
\$CCSNQ, ERS *24<cr><lf>	Erase recall data	STATUS
\$CCSNQ, RCO *3E<cr><lf>	Read Current Options	OPTIONS
\$CCSNQ, COR *3E<cr><lf>	Distance Correction	OPTIONS
\$CCSNQ, WPC , T*5C<cr><lf>	Zero Pitch and Roll Compass	ANSWER C
\$CCSNQ, HCC *28<cr><lf>	Hard Compass Calibration	ANSWER Z / ANSWER H
\$CCSNQ, SCC *33<cr><lf>	Soft Compass Calibration	ANSWER U/ R/ D/ L /ANSWER I

\$CCSNQ, TST *33<cr><lf>	Self-Test	ANSWER T , followed by ANSWER P0000/FXXXX ¹
\$CCSNQ, GAD ,declination* cs<cr><lf>	GPS: Change Azimuth Declination in degrees	OPTIONS
\$CCSNQ, WPC , F*4E<cr><lf>	Write Parameters to Compass: Factory default	ANSWER C
\$CCSNQ, BRT ,mode brt,level brt*cs<cr><lf>	Write display brightness	ANSWER R
\$CCSNQ, DCD ,w_corr,nor m_ampl,b_corr*cs<cr><lf>	Write Distance Correction Data	OPTIONS

Notes:

1. Definitions:

Std = measurement standard

unit_d = unit of measurement for distance

unit_c = unit of measurement for compass and inclinometer

gate = gating value

target = target selection logic

aim = selection of the OLED reticle

repeat = cannot be modified by user
action_time = cannot be modified by user

idle time = cannot be modified by user

wd_time = shut-off time in seconds.

2. cs -checksum, “xor” of all bytes after “\$” and before “*”,
represented in ASCII code.

¹ See table with types of typical failures and their codes

3. Default: gate = “0”, mode = “DAI”, unit_d = “m”, unit_c = “mils”, target = “AUTO”, aim = dot reticle, WD time = 16 sec.
4. Magnetic declination is required for accurate target calculations, every time when unit is used in a new country or territory, the new magnetic declination value shall be entered. The value of magnetic declination can be found on the following website:
<http://geomag.nrcan.gc.ca/calc/mdcal-eng.php>

Description of typical errors:

TEST ERROR (\$PNCOFXXXX)

Most significant core (FXXxx)

Code F	Description
00	All functions and modules are operating normally
01	Compass failed
02	GPS failed
03	Compass and GPS failed

Less significant core (FxxXX)

Code F	Description
00	All functions and modules are operating normally
01	RAM FPGA failed
02	Receiver failure. Low sensitivity (LS)
03	RAM FPGA and receiver (LS) failed
04	Receiver failure. Noise over limit (NOL).
05	Receiver (NOL) and RAM FPGA failed
06	Receiver (NOL) and receiver (LS) failed
07	Receiver (NOL), receiver (LS) and RAM FPGA failed

Compass calibration errors (\$PNCOFXX)

Code F	Leveling	Description
00	Pitch =0, Roll =0	Correct compass position
01	Pitch =0, Roll >3°	XY calibration position failed
10	Pitch >3°, Roll =0	Z calibration position failed
11	Pitch >3°, Roll >3°	Too large error at the end of soft calibration

3. LRF default state (factory settings)

Gating value, Gate = 0 meters

Measuring mode = “DAI”

Distance units of measurement = “m”

Compass and inclination units of measurements = “Mils”

Target selection = “AUTO”

Aiming reticle - Dot

Auto shutoff time = 16 sec

Electronic reticle: ON

4. LRF STATUS

LRF's status represents all current device settings including battery status

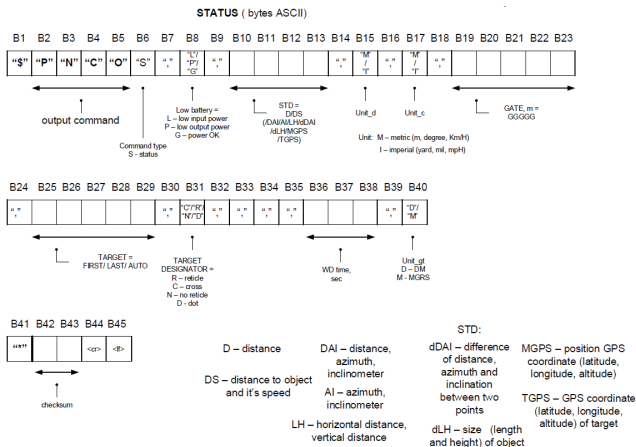

Abbreviation	Definition
D	distance
DS	distance with speed
DAI	distance, azimuth, inclination
AI	azimuth, inclination
LH	horizontal distance, height/depth
dDAI	distance, azimuth, inclination between two points

dLH	size of any object (length, height)
MGPS	GPS coordinates of the current device position (latitude, longitude, altitude)
TGPS	GPS coordinates of the target (latitude, longitude, altitude)

5. LRF OPTIONS

The LRF option represents hardware and software versions of the device, current value of distance correction coefficient and battery status.

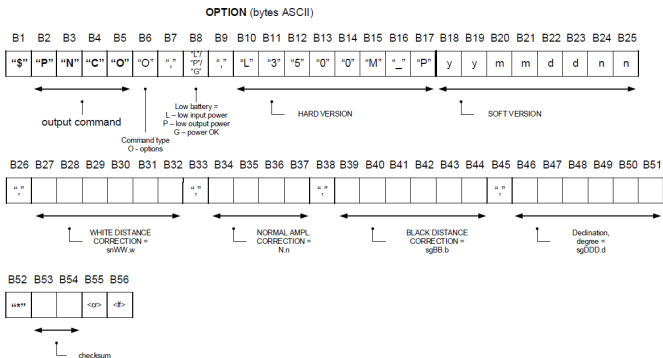

6. LRF NEW STATUS

New status represents device settings.

NEW STATUS (bytes ASCII)

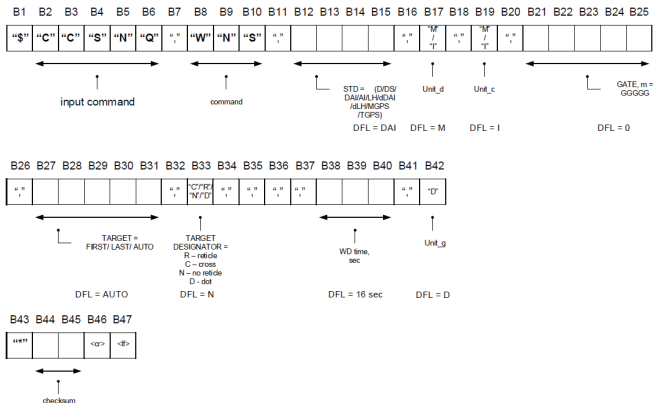

By changing the device STATUS, operator is able to change the following parameters:

1. Measurement mode
2. Units of measurements
3. Gating value, provided in meters
4. Target selection logic
5. Enable or disable electronic reticle
6. Auto-shut off time in seconds

7. LRF ANSWERS

The LRF's ANSWER represents updates or errors in the active procedures such as calibration or measurement.

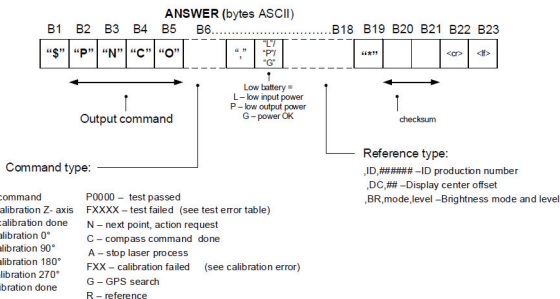

8. LRF RESULT/RECALL

The LRF's result output has following structure:

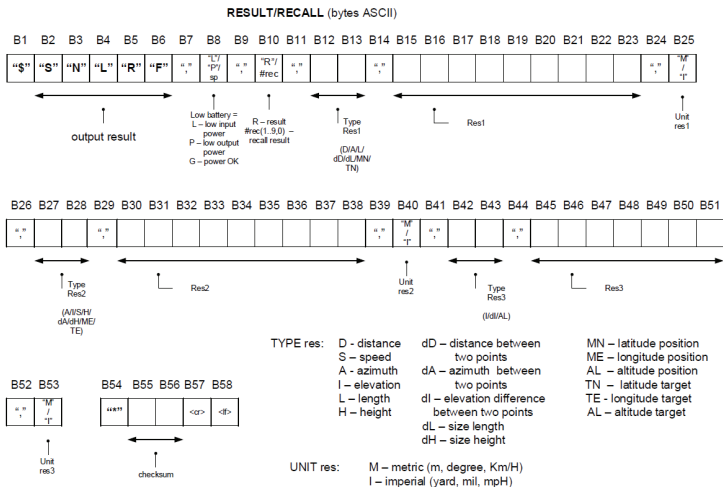

LRM 3500M Communication Protocol Rev 1.0

CP1-07.16

NEWCON OPTIK™

Printed in Canada