

SENSOR SWITCH

Item.#	RBS3109 系列	Description	ROLL BALL SWITCH	Version	V101.2
Page	1 of 16		Date	May 24, 2012	

● 功能

1. 全周 360° 倾倒侦测

● 应用

1. 液晶屏幕翻转
2. 家电倾倒自动断电系统
3. 运动器材断电安全装置
4. 警报系统
5. 防盗、防篡改装置
6. 生物移动侦测(人身定位器)
7. 系统唤醒装置
8. 机车倾斜自动断电
9. 地震感测



● 特性

1. 外壳采用高绝缘性塑料材料，可避免外壳导电或生锈。
2. 采用光敏晶体管感测讯号，不受金属氧化或磨损的影响。
3. 所有塑料材料均使用高耐温之工程塑料。
4. 开关讯号单纯，线路设计容易。
5. 适用于垂直电路板。
6. 倾斜角度：15°、20°、30°、45°角四种选择，全周 360°角皆可检测无死角。
7. 符合 RoHS 标准，完全替代水银开关。
8. 比 IC 设计经济的解决方案。
9. 台湾制造，出厂全检。



SENSOR SWITCH

Item.#	RBS3109 系列	Description	ROLL BALL SWITCH	Version	V101.2
Page	2 of 16		Date	May 24, 2012	

- 专利
 1. 台湾专利第 I 310952 号
 2. 美国专利第 US 6,800,841 B1 号
 3. 美国专利第 US 7,402,791 B2 号
 4. 中国大陆专利第 ZL 200610083013.5 号
 5. 日本专利第 4384217 号

- 尺寸 / 运用 / 电路板布线图 (单位: mm,公差: ±0.25mm)

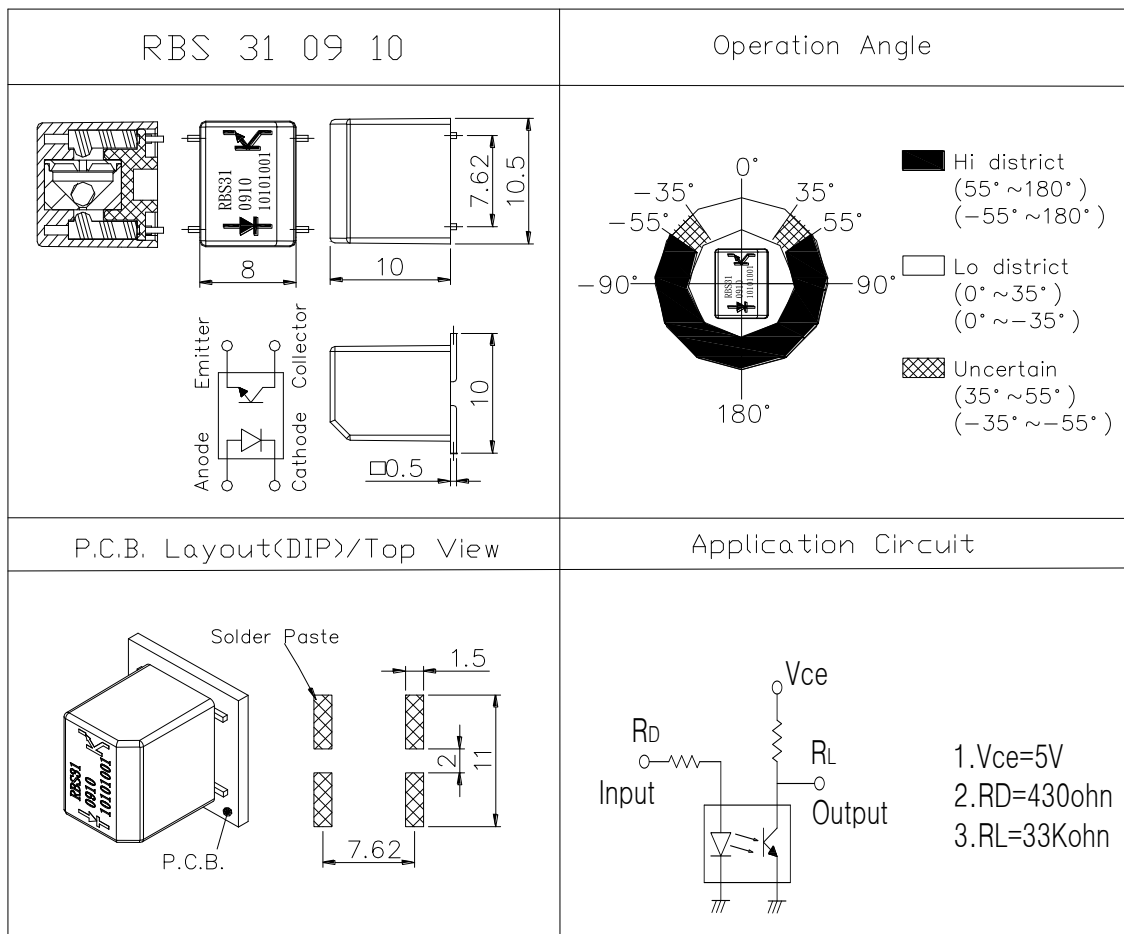

SENSOR SWITCH

Item.#	RBS3109 系列	Description	ROLL BALL SWITCH	Version	V101.2
Page	3 of 16		Date	May 24, 2012	

<p>RBS 31 09 11</p>	<p>Operation Angle</p> <p> Hi district (40° ~ 180°) (-40° ~ 180°) </p> <p> Lo district (0° ~ 20°) (0° ~ -20°) </p> <p> Uncertion (-20° ~ 40°) </p>
<p>P.C.B. Layout(DIP)/Top View</p>	<p>Application Circuit</p> <p> 1. Vce=5V 2. RD=430ohn 3. RL=33Kohn </p>



SENSOR SWITCH

Item.#	RBS3109 系列	Description	ROLL BALL SWITCH	Version	V101.2
Page	4 of 16		Date	May 24, 2012	

<p>RBS 31 09 12</p>	<p>Operation Angle</p> <ul style="list-style-type: none"> ■ Hi district (30° ~ 180°) (-30° ~ -180°) □ Lo district (0° ~ 10°) (-0° ~ -10°) ▨ Uncertain (10° ~ 30°) (-10° ~ -30°)
<p>P.C.B. Layout(DIP)/Top View</p>	<p>Application Circuit</p> <ul style="list-style-type: none"> 1. Vce=5V 2. RD=430ohm 3. RL=33Kohm



SENSOR SWITCH

Item.#	RBS3109 系列	Description	ROLL BALL SWITCH	Version	V101.2
Page	5 of 16		Date	May 24, 2012	

<p style="text-align: center;">RBS 31 09 13</p>	<p style="text-align: center;">Operation Angle</p> <ul style="list-style-type: none"> Hi district (25°~180°) (-25°~180°) Lo district (0°~5°) (0°~-5°) Uncertion (5°~25°) (-5°~-25°)
<p style="text-align: center;">P.C.B. Layout(DIP)/Top View</p>	<p style="text-align: center;">Application Circuit</p> <ul style="list-style-type: none"> 1. Vce=5V 2. RD=430ohn 3. RL=33Kohn



SENSOR SWITCH

Item.#	RBS3109 系列	Description	ROLL BALL SWITCH	Version	V101.2
Page	6 of 16		Date	May 24, 2012	

<p style="text-align: center;">RBS 31 09 42</p>	<p style="text-align: center;">Operation Angle</p> <ul style="list-style-type: none"> Hi district (30°~180°) (-30°~-180°) Lo district (0°~10°) (0°~-10°) Uncertain (10°~30°) (-10°~-30°)
<p style="text-align: center;">P.C.B. Layout(DIP)/Top View</p>	<p style="text-align: center;">Application Circuit</p> <ol style="list-style-type: none"> 1. Vce=5V 2. RD=430ohm 3. RL=33Kohm



SENSOR SWITCH

Item.#	RBS3109 系列	Description	ROLL BALL SWITCH	Version	V101.2
Page	7 of 16		Date	May 24, 2012	

<p>RBS 31 09 62</p>	<p>Operation Angle</p>
<p>P.C.B. Layout(DIP)/Top View</p>	<p>Application Circuit</p>

● 建议电流、电压条件

输入电流 (mA)	操作电压 (V)
10	5



SENSOR SWITCH

Item.#	RBS3109 系列	Description	ROLL BALL SWITCH	Version	V101.2
Page	8 of 16		Date	May 24, 2012	

● Absolute Maximum Rating (Ta=25°C)

	Item	Symbol	Rating	Unit
Input	Power Dissipation	Pd	75	mW
	Reverse Voltage	Vr	5	V
	Forward Current	IF	50	mA
	Peak Forward Current (*1)	IFP	1	A
Output	Collector Power Dissipation	Pc	100	mW
	Collector Current	Ic	20	mA
	C-E Voltage	VCEO	30	V
	E-C Voltage	VECO	5	V
Operating Temperature		Topr	-25~+85	°C
Storage Temperature		Tstg	-40~+100	°C
Soldering Temperature (*2)		Tsol	260	°C

(*1) tw=100 uSec., T=10 mSec.

(*2) t=5 Sec

● 机械特性

1.	温度范围	工作中: -25°C to +85°C 存放: -40°C to +85°C
2.	端子拉力	500 gf, 1 分钟
3.	操作寿命	30,000 小时
4.	湿度	95% RH 40°C, 96 小时
5.	焊接性	锡炉温度 260±5°C 试验时间 5±0.5 秒, 锡覆盖面积达 95%
6.	热流焊锡	热流区 260±5°C, 20 秒(最大值)



SENSOR SWITCH

Item.#	RBS3109 系列	Description	ROLL BALL SWITCH	Version	V101.2
Page	9 of 16		Date	May 24, 2012	

●光电、电性特性 (Ta=25°C)

Parameter	Symbol	Condition	Min.	Typ.	Max.	Unit
Forward Voltage	VF	IF=20mA	—	—	1.5	V
Reverse Current	IR	VR=5V	—	—	10	μA
Peak Wavelength	λp	IF=10mA		940		nm
Dark Current	ID	VCE=10V	—	—	2	μA
C-E Saturation Voltage	VCE (sat)	IC=0.25mA IF=20mA	—	—	0.4	V
Light Current	IL	VCE=5V IF=20mA	0.5	5	—	mA
Rise Time	Tr	IC=0.8mA	—	5	—	μsec
Fall Time	Tf	Vcc=30V RL=1KΩ	—	5	—	μsec



SENSOR SWITCH

Item.#	RBS3109 系列	Description	ROLL BALL SWITCH	Version	V101.2
Page	10 of 16		Date	May 24, 2012	

● 光电、电性特性曲线 (Ta=25°C)

Fig.1 Power Dissipation vs. Ambient Temperature

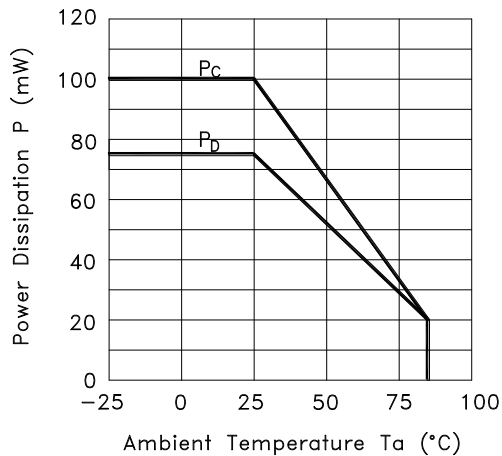

Fig.2 Forward Current vs. Forward Voltage

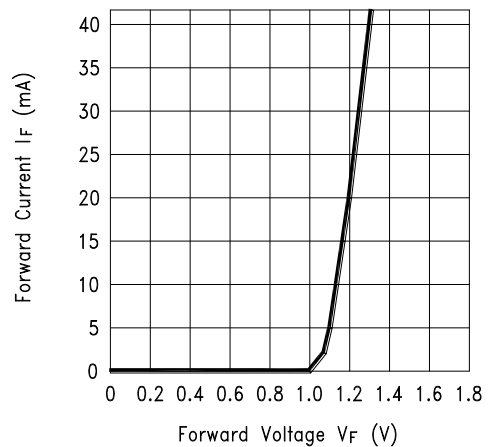

Fig.3 Collector Current vs. Collector-emitter Voltage

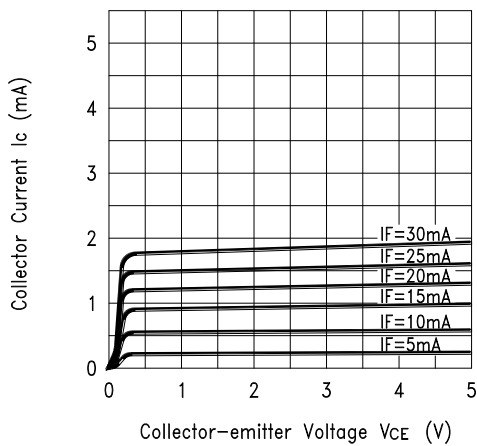
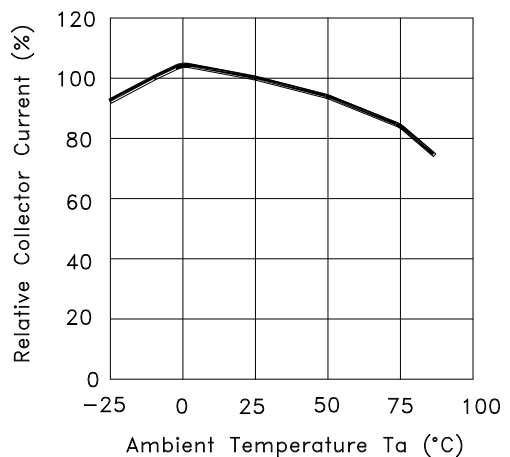

Fig.4 Collector Current vs. Ambient Temperature



SENSOR SWITCH

Item.#	RBS3109 系列	Description	ROLL BALL SWITCH	Version	V101.2
Page	11 of 16		Date	May 24, 2012	

Fig.5 Collector-emitter Saturation Voltage vs. Ambient Temperature

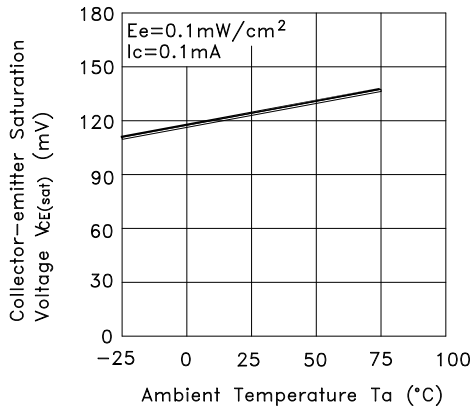

Fig.6 Response Time vs. Load Resistance

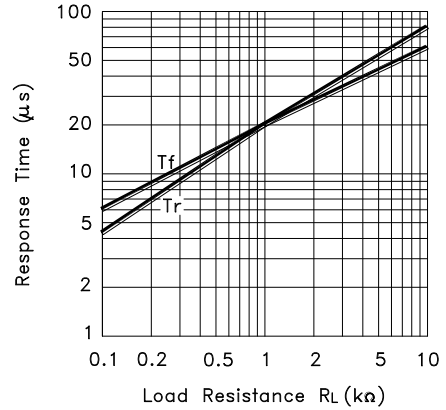
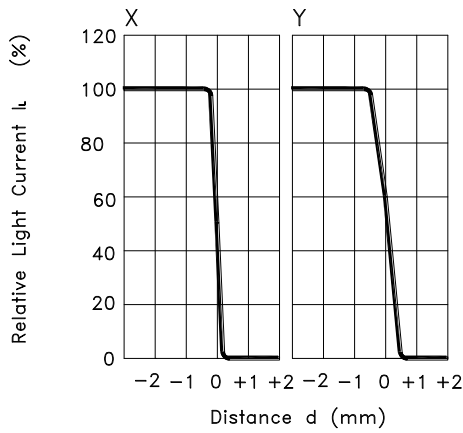
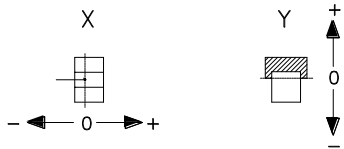

Fig.7 Sensing Position Characteristics (Typical)



(Center of Optical axis)



Test Circuit for Response Time

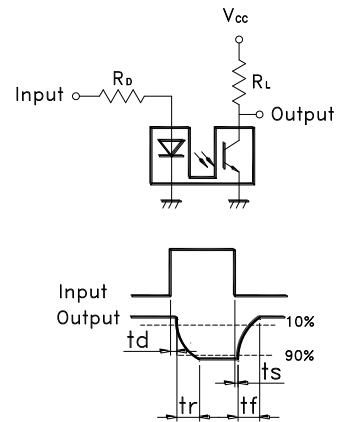

SENSOR SWITCH

Item.#	RBS3109 系列	Description	ROLL BALL SWITCH	Version	V101.2
Page	12 of 16		Date	May 24, 2012	

● 可靠度测试项目

以下的表格呈现的是 RBS3109 系列的操作寿命、机械，与环境测试。

测试项目	依据规范	测试内容
储存温度	MIL-STD-202G, TEST METHOD 107G, TEST A	-40°C ~85°C
红外线回焊炉	MIL-STD-202G, TEST METHOD 210F、 IPC/JEDEC J-STD-020D	Peak temp.=255~260°C *3times
湿度	MIL-STD-202G, TEST METHOD 103B	40°C/95%RH
操作温度	MIL-STD-202G, TEST METHOD 107G, TEST A	-25°C ~85°C
机械寿命	--	2Hz 水平
电气寿命	MIL-STD-883E:1016	IF=20mA VCE=5V TIME:1,000hrs



SENSOR SWITCH

Item.#	RBS3109 系列	Description	ROLL BALL SWITCH	Version	V101.2
Page	13 of 16		Date	May 24, 2012	

● 焊锡温度及时间

以下回焊的档案数据仅供参考,建议使用者依照焊剂制造商推荐的焊接档案数据来进行,红外线回焊炉参考曲线如下。

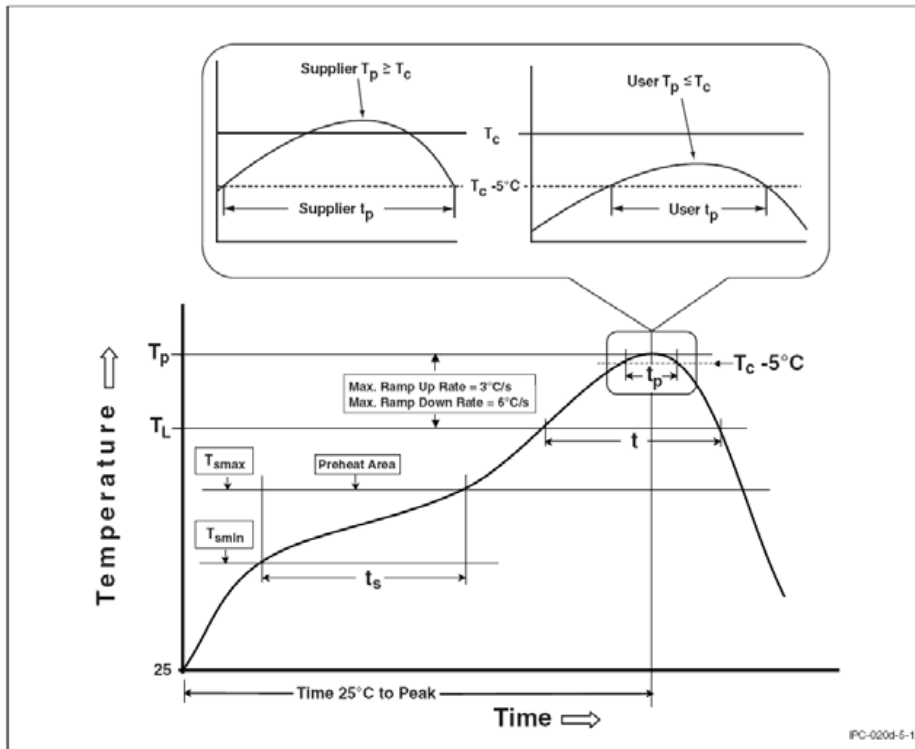

SENSOR SWITCH

Item.#	RBS3109 系列	Description	ROLL BALL SWITCH	Version	V101.2
Page	14 of 16		Date	May 24, 2012	

< 回焊资料分类表 >

主要项目	有铅制程	无铅制程
预热与浸泡		
温度最小值(Tsmin)	100 ° C	150 ° C
温度最大值(Tsmax)	150 ° C	200 ° C
时间(Tsmin to Tsmax)(ts)	60-120 seconds	60-120 seconds
平均爬升率(Tsmax to Tp)	3 ° C/second max.	3 ° C/second max.
液化温度 (TL)	183 ° C	217 ° C
液化时间 (tL)	60-150 seconds	60-150 seconds
峰值封装主体温度(Tp)*	230 ° C ~235 ° C *	255 ° C ~260 ° C *
分级温度(Tc)	235 ° C	260 ° C
分级温度(Tc)在 5 ° C 之内的确切时间(tp)**	20** seconds	30** seconds
平均下降率 (Tp toTsmax)	6 ° C/second max.	6 ° C/second max.
25 ° C 至温度尖峰的时间	6 minutes max.	8 minutes max.
*温度曲线尖峰值 (Tp): 温度公差定义为供应者的最小值与使用者的最大值		
**温度曲线尖峰值 (tp): 时间公差定义为供应者的最小值与使用者的最大值		



SENSOR SWITCH

Item.#	RBS3109 系列	Description	ROLL BALL SWITCH	Version	V101.2
Page	15 of 16		Date	May 24, 2012	

● 包装

	料号	包装	数量	总数	尺寸(mm)
1.	RBS310910T	料带	350 pcs	350 pcs	φ 330*25H
	RBS310911T				
	RBS310912T	内箱	2 Reels	700 pcs	355L*340W*68H
	RBS310913T				
	RBS310915T				
	RBS310942T	外箱	10 内箱	7,000 pcs	705L*365W*375H
	RBS310962T				

※包装流程如下：产品图片仅供参考！

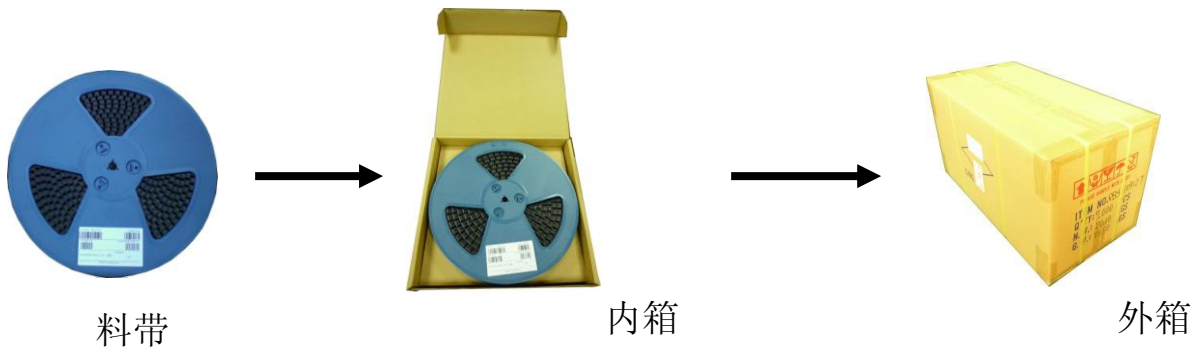

SENSOR SWITCH

Item.#	RBS3109 系列	Description	ROLL BALL SWITCH	Version	V101.2
Page	16 of 16		Date	May 24, 2012	

● 备注

1. 使用建议：使用于具震动场合时，建议加上 on delay 的设计；若震动过大时，建议选用光电式产品。
2. 由于公司政策是不断的改善产品质量，因此规格书可能在没有知会的情况下变更或修改，您可以透过本公司的业务人员取得最新信息。在一般情况下，本公司所有产品都是依照规格书的标准条件生产。
3. 导通率:针对开关进行 ON/OFF 测试，在 100 次的测试中，如果有 95 次导通，我们称导通率 95%。

● 注意事项

1. 如果该产品要用于其它具有更高安全性及可靠性的耐久设备中（如生命维持装置、宇宙航空装置、防灾及安全性装置）时，请确认是否合用，或者问我方了解详细情况。
2. 焊接流程完成后，请勿使用溶剂或类似物品清洗开关。
3. 使用水溶性助焊剂可能导致开关破损。
4. 当焊接温度超过规格书规范时，开关可能会分离。
5. 不要将开关用于高湿或有沾湿可能性的环境中，因这样的环境可能会引起端子间之漏电流。
6. 超过额定负荷使用时，有发生火灾的可能性，故请勿超过负荷使用。
7. 于电路中不得靠近或与强磁组件焊点直接接通(例如:继电器、变压器..等)。

