

TECHNICAL HANDBOOK

iinb74en1-11 (1811) Translation of the original handbook



Catalog-No.

550-500A,
550-501A

from software version V 5.17

UL5000

Helium Leak Detector

Table of contents

| | | |
|----------|--|-----------|
| 1 | General Information | 6 |
| 1.1 | Notes on the Use of this Handbook | 6 |
| 1.1.1 | Safety Symbols | 6 |
| 1.1.2 | Indications | 7 |
| 1.1.3 | Symbols of Vacuum Technology | 7 |
| 1.1.4 | Definition of Terms | 7 |
| 1.2 | Support from INFICON Service | 9 |
| 1.3 | Introduction | 10 |
| 1.3.1 | Purpose | 10 |
| 1.3.2 | Technical Data | 11 |
| 1.3.2.1 | Physical Data | 11 |
| 1.3.2.2 | Electrical Data | 12 |
| 1.3.2.3 | Other Data | 12 |
| 1.3.2.4 | Ambient Conditions | 12 |
| 1.4 | Unpacking | 12 |
| 1.4.1 | Supplied Equipment | 13 |
| 1.4.2 | Accessories and Options | 14 |
| 1.4.2.1 | Sniffer line SL200 | 14 |
| 1.4.2.2 | Toolbox | 14 |
| 1.4.2.3 | Helium Bottle Holder | 14 |
| 1.4.2.4 | ESD Mat | 14 |
| 1.4.2.5 | RC1000 Remote control | 15 |
| 2 | Installation | 16 |
| 2.1 | Transportation | 16 |
| 2.2 | Working Location | 18 |
| 2.3 | Electrical Connections | 19 |
| 2.3.1 | Mains Power | 19 |
| 2.3.2 | Connections for the Data Acquisition Systems | 21 |
| 2.3.2.1 | Accessories | 22 |
| 2.3.2.2 | Digital Out | 22 |
| 2.3.2.3 | Digital In | 23 |
| 2.3.2.4 | Recorder | 24 |
| 2.3.2.5 | RS232 | 25 |
| 2.3.2.6 | Remote Control RC1000 / Wireless Transmitter | 25 |
| 2.4 | Vacuum Connections | 26 |
| 2.4.1 | Inlet Port | 26 |
| 2.4.2 | Exhaust | 26 |
| 2.4.3 | Vent | 26 |
| 2.4.4 | Purge | 26 |
| 2.5 | Default parameters | 27 |
| 3 | First Operation Check | 28 |
| 3.1 | Needed Equipment | 28 |
| 3.2 | Description of the Initial Operation | 28 |
| 3.2.1 | Startup and Measure | 28 |

| | | |
|----------|--|-----------|
| 3.2.2 | Internal Calibration | 31 |
| 3.2.3 | Verification | 31 |
| 4 | Description and Working Principle | 32 |
| 4.1 | Introduction | 32 |
| 4.2 | Components of the UL5000 | 32 |
| 4.2.1 | Vacuum System | 32 |
| 4.2.2 | Control Panel | 34 |
| 4.2.2.1 | LC Display | 34 |
| 4.2.2.2 | START Button | 34 |
| 4.2.2.3 | STOP Button | 35 |
| 4.2.2.4 | ZERO Button | 35 |
| 4.2.2.5 | MENU Button | 36 |
| 4.2.2.6 | Soft Keys | 36 |
| 4.2.2.7 | Numerical Entries | 37 |
| 4.3 | Working Modes | 38 |
| 4.3.1 | Vacuum Mode | 38 |
| 4.3.2 | Sniffer Mode | 39 |
| 5 | Operation of the UL5000 | 40 |
| 5.1 | Display | 40 |
| 5.2 | The Screen in Run-Up Mode | 40 |
| 5.3 | Display in stand-by mode | 40 |
| 5.3.1 | Purging | 41 |
| 5.4 | The Screen in Measurement Mode | 41 |
| 5.4.1 | Call for Calibration | 41 |
| 5.4.2 | Speaker Volume | 42 |
| 5.4.3 | Status Line in the Display | 42 |
| 5.4.4 | Numerical Display Mode | 43 |
| 5.4.5 | Trend Mode | 43 |
| 5.4.6 | HYDRO•S on / off | 43 |
| 6 | Description of the Menu | 44 |
| 6.1 | Main Menu | 44 |
| 6.2 | View | 46 |
| 6.2.1 | Scale linear/logarithmic | 46 |
| 6.2.2 | Display-range auto/manual | 47 |
| 6.2.3 | Time axis | 47 |
| 6.2.4 | Contrast | 48 |
| 6.2.5 | Background in Stand-by | 48 |
| 6.2.6 | Decimal places | 49 |
| 6.2.7 | Lower display limit | 49 |
| 6.3 | Mode | 50 |
| 6.4 | Trigger & Alarms | 51 |
| 6.4.1 | Trigger Level 1 | 51 |
| 6.4.2 | Trigger Level 2 | 52 |
| 6.4.3 | Volume | 52 |
| 6.4.4 | Units | 53 |
| 6.4.5 | Alarm delay | 53 |

| | | |
|----------|---------------------------------|-----------|
| 6.4.6 | Audio alarm type | 54 |
| 6.4.6.1 | Pinpoint | 54 |
| 6.4.6.2 | Leak rate prop. | 54 |
| 6.4.6.3 | Setpoint | 55 |
| 6.4.6.4 | Trigger alarm | 55 |
| 6.5 | Calibration | 55 |
| 6.6 | Settings | 56 |
| 6.6.1 | Vacuum settings | 57 |
| 6.6.1.1 | Automatic purge | 57 |
| 6.6.1.2 | Vent delay | 58 |
| 6.6.1.3 | Vacuum ranges | 58 |
| 6.6.1.4 | HYDRO•S | 59 |
| 6.6.1.5 | Leak rate internal test leak | 59 |
| 6.6.1.6 | Machine factor | 60 |
| 6.6.1.7 | Booster TMP mode | 60 |
| 6.6.2 | Zero & Background | 60 |
| 6.6.2.1 | Background Suppression | 61 |
| 6.6.2.2 | Calculate Inlet Area Background | 61 |
| 6.6.2.3 | Zero | 62 |
| 6.6.3 | Mass | 62 |
| 6.6.4 | Interfaces | 63 |
| 6.6.4.1 | Control Location | 63 |
| 6.6.4.2 | Recorder output | 64 |
| 6.6.4.3 | RS232 Protocol | 65 |
| 6.6.4.4 | Scaling Recorder Output | 66 |
| 6.6.5 | Miscellaneous | 67 |
| 6.6.5.1 | Time&Date | 67 |
| 6.6.5.2 | Language | 67 |
| 6.6.5.3 | Leak rate filter | 68 |
| 6.6.5.4 | Mains Frequency | 68 |
| 6.6.5.5 | Service interval exhaust filter | 68 |
| 6.6.5.6 | Service message exhaust filter | 69 |
| 6.6.6 | Parameter save / load | 69 |
| 6.6.6.1 | Save parameter set | 70 |
| 6.6.6.2 | Load parameter set | 70 |
| 6.6.7 | Monitoring functions | 70 |
| 6.7 | Information | 73 |
| 6.7.1 | Service | 73 |
| 6.8 | Access Control | 74 |
| 6.8.1 | Access to CAL function | 74 |
| 6.8.2 | Access to Trigger&Alarme menu | 75 |
| 6.8.3 | Change Device PIN | 75 |
| 6.8.4 | Change Menu-PIN | 75 |
| 7 | Calibration | 76 |
| 7.1 | Introduction | 76 |
| 7.2 | The calibration routines | 76 |
| 7.2.1 | Internal Calibration | 77 |
| 7.2.1.1 | Automatic Internal Calibration | 77 |
| 7.2.1.2 | Manual Internal Calibration | 77 |

| | | |
|-----------|---|------------|
| 7.2.2 | External Calibration | 77 |
| 7.3 | Factor of Calibration - Range of Values | 80 |
| 8 | Error And Warning Messages | 81 |
| 8.1 | Hints | 81 |
| 8.2 | List of Errors & Warnings | 82 |
| 9 | Maintenance works | 87 |
| 9.1 | Hints | 87 |
| 9.2 | INFICON Service | 88 |
| 9.3 | Key for Maintenance Schedule | 89 |
| 9.4 | Maintenance Plan | 89 |
| 9.5 | Maintenance groups | 90 |
| 9.5.1 | 1500 hours maintenance | 90 |
| 9.5.2 | 4000 hours maintenance | 91 |
| 9.5.3 | 8000 hours maintenance | 92 |
| 9.5.4 | 16000 hours maintenance | 93 |
| 9.5.5 | 24000 hours maintenance | 94 |
| 9.6 | Description of the maintenance work | 95 |
| 9.6.1 | Opening the UL5000 | 95 |
| 9.7 | Check/Replace the filter cell | 96 |
| 9.8 | Replacing the Exhaust Silencer | 98 |
| 9.9 | Turbomolecular pump SplitFlow 80 | 99 |
| 9.10 | Scroll Pump | 99 |
| 10 | Declaration of Conformity | 100 |
| | <hr/> | |
| | Index | 101 |

1 General Information

Notice: We recommend that you carefully read this technical handbook to ensure optimum operating conditions right from the start.

This technical handbook contains important informations on the functions, installation, start-up and operation of the UL5000.

General

We reserve the right to modify the design and the specified data. The illustrations are not binding.

1.1 Notes on the Use of this Handbook

1.1.1 Safety Symbols

Important remarks concerning operational safety and protection are emphasised as follows:



Caution

Information on correct handling or use. Disregard can lead to malfunctions or minor equipment damage.



Warning

Information on preventing extensive equipment and environmental damage.



Danger

Information on preventing any kind of physical injury.



Skilled personnel

Indicates procedures that must be performed by skilled personnel only.

1.1.2 Indications

Tip Information on helpful procedures.

Notice: Information on special technical requirements that the user must comply with.

The references to diagrams consists of the Chapter number, figure number and the item number in this order. For example: Fig. 2-4/7 refers to item 7 in the figure 4 of Chapter 2.

1.1.3 Symbols of Vacuum Technology

Given in the following are some important vacuum symbols which are used in this manual.



Vacuum pump in general



Turbomolecular pump



Pressure gauge



Valve

1.1.4 Definition of Terms

Autoranging

The range of the preamplifier and the vacuum ranges are selected automatically.

The autoranging feature of the UL5000 covers the entire range of leak rates depending on the selected operating mode. Not only the leak rate signal, but also the pressure in the test sample (inlet pressure P1) and the fore vacuum pressure (P2) are used for control purposes. Range switching between the main ranges is performed via valves. Fine range switching within the main ranges is implemented by switching over the gain factor of the preamplifier.

Autotune Mass alignment

This function automatically aligns the mass spectrometer so that a maximum leak rate is displayed. The control processor changes the voltage which erates the ions in the selected mass range until a maximum ion current is detected by the ion detector. During each calibration the mass alignment is run automatically.

Auto zero

Determination and automatic adaptation of the helium background.

Through this function, the internal zero level of the instrument is determined which is then subtracted from the current leak rate signal. This function is run during the calibration process or when operating the start pushbutton, provided the UL5000 has been running previously for at least 20 seconds in the standby or vent mode. If the helium background previously suppressed should drop so that for the duration of the zero time only the display limit will be displayed, the zero level is adapted automatically.

Menu

The menu allows the user to program the UL5000 according to his requirements. The menu has a tree architecture.

Default

Status of the UL5000 when supplied by the factory.

GROSS

GROSS is a measurement mode which allows high inlet pressure (1 to 15 mbar). The smallest detectable leak rate is 1×10^{-6} mbar l/s.

FINE

FINE is the medium measurement mode with inlet pressure between 2 and 0,4 mbar. Detection limit is 1×10^{-10} mbar l/s.

ULTRA

ULTRA is the most sensitive measuring range with inlet pressures below 0,4 mbar. The minimum detectable leak rate is $< 5 \times 10^{-12}$ mbar l/s.

Foreline pressure

Pressure in the foreline between Turbo pump and scroll pump.

Minimum detectable leak rate

The smallest leak rate the UL5000 is able to detect ($\leq 5E-12$ mbar l/s).

Internal helium background

The existing helium partial pressure in the measurement system. The level of the internal helium background is measured in the Stand-by mode and subtracted from the measured signal.

Measure Measurement mode

The UL5000 measures the leak rate of the test sample.

1.2 Support from INFICON Service

If an instrument is returned to INFICON or an authorised representative of INFICON, please indicate whether the instrument is free of substances damaging to health or whether it is contaminated. If it is contaminated also indicate the nature of the hazard. INFICON must return any appliances without a *Declaration of Contamination* to the sender's address. A form for stating details as to the type of contamination is reproduced in Fig. 1-1.

A maintenance and service contract is recommended.

Declaration of Contamination

The service, repair, and/or disposal of vacuum equipment and components will only be carried out if a correctly completed declaration has been submitted. Non-completion will result in delay.
This declaration may only be completed (in block letters) and signed by authorized and qualified staff.

1 Description of product

Type _____
Article Number _____
Serial Number _____

2 Reason for return

3 Operating fluid(s) used (Must be drained before shipping.)

4 Process related contamination of product:

| | | | |
|--------------------------|--------------------------------|---------------------------------|--|
| toxic | no <input type="checkbox"/> 1) | yes <input type="checkbox"/> | |
| caustic | no <input type="checkbox"/> 1) | yes <input type="checkbox"/> | |
| biological hazard | no <input type="checkbox"/> | yes <input type="checkbox"/> 2) | |
| explosive | no <input type="checkbox"/> | yes <input type="checkbox"/> 2) | |
| radioactive | no <input type="checkbox"/> | yes <input type="checkbox"/> 2) | |
| other harmful substances | no <input type="checkbox"/> 1) | yes <input type="checkbox"/> | |

2) Products thus contaminated will not be accepted without written evidence of decontamination!

The product is free of any substances which are damaging to health yes

1) or not containing any amount of hazardous residues that exceed the permissible exposure limits

5 Harmful substances, gases and/or by-products

Please list all substances, gases, and by-products which the product may have come into contact with:

| Trade/product name | Chemical name (or symbol) | Precautions associated with substance | Action if human contact |
|--------------------|---------------------------|---------------------------------------|-------------------------|
| | | | |
| | | | |
| | | | |
| | | | |

6 Legally binding declaration:

I/we hereby declare that the information on this form is complete and accurate and that I/we will assume any further costs that may arise. The contaminated product will be dispatched in accordance with the applicable regulations.

Organization/company _____

Address _____ Post code, place _____

Phone _____ Fax _____

Email _____

Name _____

Date and legally binding signature _____ Company stamp _____

This form can be downloaded from our website. Copies: Original for addressee - 1 copy for accompanying documents - 1 copy for file of sender

INFICON GmbH

Bonner Str. 498, 50968 Cologne, Germany
Tel: +49 221 3474 2222 Fax: +49 221 3474 2221
www.inficon.com leakdetection.service@inficon.com zisa01e1-a

Fig. 1-1: Declaration of Contamination form

1.3 Introduction

1.3.1 Purpose

The UL5000 is a helium leak detector. This instrument may be used to detect the location and the size of leaks on objects under test in two different ways:

- when the test sample has been evacuated first and is sprayed with helium on the outside. It is required that a vacuum connection is provided between the UL5000 and the test sample (vacuum mode).

or

- when a helium overpressure is provided in the test sample and the test sample is searched from the outside with a sniffer probe which is attached to the inlet port (sniffer mode).



Danger

Caution: Danger of explosion:

Hydrogen forms a highly explosive gas mixture with air.

Great caution is necessary when using hydrogen! No smoking, no naked flames, avoid sparks.



Danger

Dangerous gases pollute the machine.

So you must not use the machine for detecting toxic, acidic, microbiological, explosive, radioactive or other noxious matters.

If you plan to detect noxious matters please contact the manufacturer. Rules for decontamination will be developed then. If the leak detector already has been in contact with dangerous gases please fill the declaration of contamination and send it back with the leak detector to INFICON.

When there are parts that have to be cleaned, please fill the declaration of decontamination, too, and send it to INFICON **before** you send the parts.



Caution

The UL5000 is to be used for leak detection only. It must not be used as a pumping system (esp. pumping aggressive or humid gases.)

1.3.2 Technical Data

1.3.2.1 Physical Data

| | |
|---|--|
| Max. inlet pressure | 15 mbar |
| Minimum detectable Helium leak rates | |
| • in vacuum mode (ULTRA) | 5×10^{-12} mbar l/s (see following CAUTION) |
| • in sniffer mode | $< 5 \times 10^{-8}$ mbar l/s |
| Maximum Helium leak rate which can be displayed | 0.1 mbar l/s |
| Measurement range | 12 decades |
| Time constant of the leak rate signal (blanked off, 63% of the final value) | <1 s |
| Roughing capability | 25 m ³ /h, 17.6 cfm (50 Hz) |
| Pumping speed (Helium) at the inlet (EN 1518) | 30m ³ /h, 21.1 cfm 60 Hz |
| • in vacuum mode | |
| – GROSS mode | 8 l/s |
| – FINE mode | 20 l/s |
| – ULTRA mode | >20 l/s |
| Detectable masses | 2, 3 and 4 |
| Mass spectrometer | 180° magnetic sector field |
| Ion source | 2 filaments; Iridium/Yttriumoxide |
| Inlet port | DN 40 KF |
| Run-up time (after starting) | ≤ 4 min |



Caution

To get down to the minimum detected leak rate range some conditions must be fulfilled:

- UL5000 has fully warmed up
- Ambient conditions must be stable (temperature, no vibration/accelerations.)
- The part under test has been evacuated long enough (background is no longer decreasing)
- ZERO must be active

1.3.2.2 Electrical Data

| | |
|--|-------------|
| Power supply, single phase (model dependent) | |
| Part no. 550 - 500A | 230 V 50 Hz |
| Part no. 550 - 501A | 115 V 60 Hz |
| Power consumption | 1200 VA |
| Power cords (EU, USA, UK) | 3 m |

1.3.2.3 Other Data

| | |
|--|-------------------|
| Valves | solenoid |
| Dimensions (L x W x H) incl. handle in mm | 1068 x 525 x 1083 |
| Dimensions (L x W x H) incl. handle in inches | 42 x 21 x 43 |
| Weight in kg | 140 |
| Weight in lbs | 308 |
| Noise level dB (A) | < 70 |
| Noise level dB (A) 0.5 m distance | 55.9 |
| Audio alarm dB (A) | 90 |
| Contamination level (according to IEC 60664-1) | 2 |
| Degree of contamination (according to IEC 60664-1) | |

1.3.2.4 Ambient Conditions

| | |
|--|--------------------|
| For use within buildings | |
| Permissible ambient temperature (during operation) | +10 °C ... +40 °C |
| Permissible storage temperature | 0 °C ... +60 °C |
| Max. rel. humidity | 80% non condensing |
| Max. permissible height above sea level (during operation) | 2000 m |

1.4 Unpacking

Unpack the UL5000 immediately after delivery, even if it will be installed later on.

Examine the shipping container for any external damage. Completely remove the packaging materials.

Check the UL5000 is complete ([1.4.1 Supplied Equipment](#)) and carefully examine the UL5000 visually.

If any damage is discovered, report it immediately to the forwarding agent and insurer. If the damaged part has to be replaced, please contact the orders department.

Tip Retain the packaging materials in the event of complaints about damage.

Tip For unpacking please use the wedge which is supplied.

1.4.1 Supplied Equipment

- Helium Leak Detector UL5000
- Exhaust filter (mounted)
- Exhaust hose adapter with clamps (see arrow 1)
- power cord fixture (see arrow 2)
- Set of fuses (see arrow 3)
- Set of tools (see arrow 4)
- Bellow Clips (2 + 2) (see arrow 5)
- Folder with documents
 - Technical Handbook UL5000
 - Spare Parts List UL5000
- hooks to wrap power cord (with screws) (see arrow 6)
- Tool to open the UL5000 (see arrow 7)
- O-Ring with filter (for use at applications with particles)
- Tool box (detachable)
- ESD mat

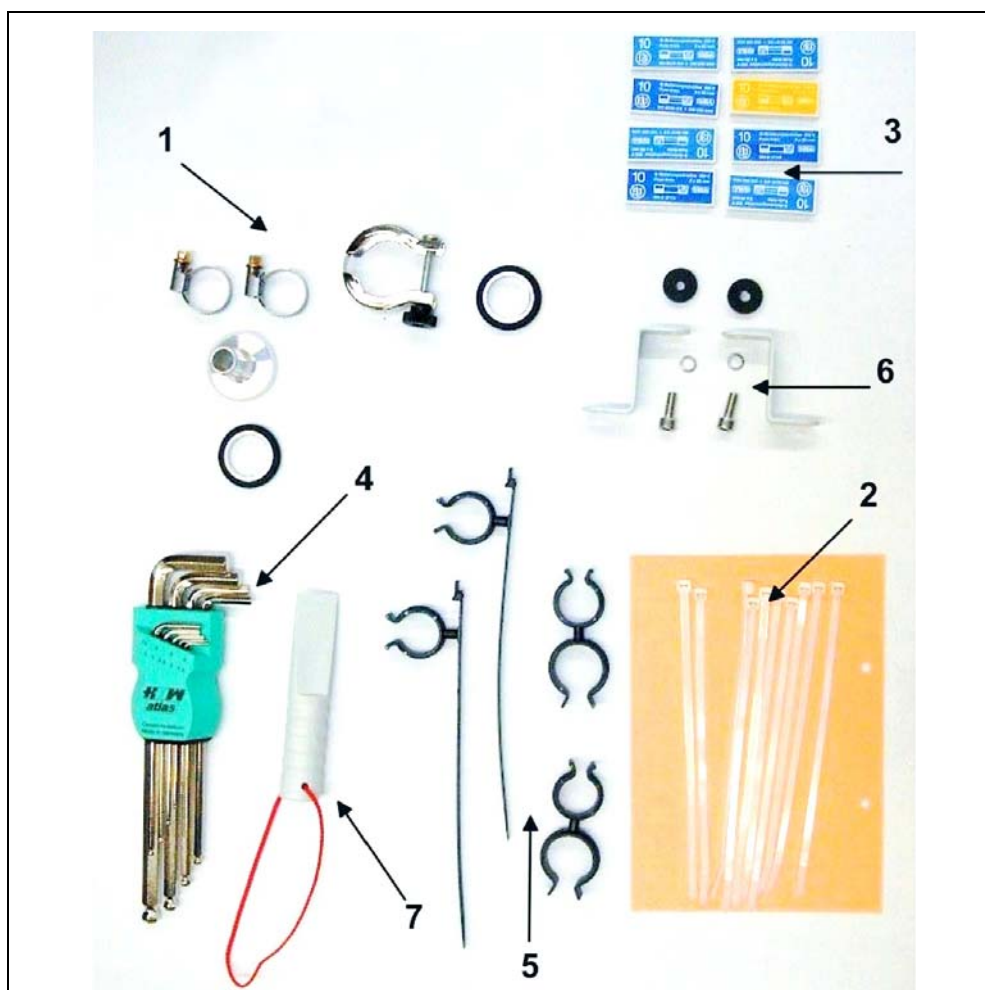

Fig. 1-2 Accessories

1.4.2 Accessories and Options

The following parts can be ordered additionally:

| | |
|---|----------|
| • Sniffer Line SL200 | 14005 |
| • Adapter 40 / 25KF (required to connect SL200) | 211-283 |
| • Tool Box (detachable) | 551-000 |
| • Helium Bottle Holder | 551-001 |
| • ESD Mat | 551-002 |
| • Remote control in two versions: | |
| – RC1000C wired | 551-010 |
| – RC1000WL wireless | 551-015 |
| Extension Cable, 10 m | 14022 |
| • Spray gun with hose | 16555 |
| • Set of plugs | 20099024 |
| • Leak Ware (software package) | 14090 |

1.4.2.1 Sniffer line SL200

By use of the sniffer line the UL5000 can easily be converted to a sniffer leak detector. The length of the sniffer line is 4m (i.e. 12 feet).

1.4.2.2 Toolbox

The toolbox is a detachable compartment with a lockable lid. Fittings and small fixtures can be stored plus the hand set (See Chapter 1.4.2.5). The storage volume is approximately 5 l.

The toolbox is placed on the working surface and jammed by the handle.

1.4.2.3 Helium Bottle Holder

The helium bottle holder allows you to carry a helium reservoir and a spray gun with the UL5000. Only small and midsize bottles (max 10 l, 200 bar) will fit without influencing the stability of the UL5000.

1.4.2.4 ESD Mat

This mat is put on the working surface of the UL5000 and is clamped and grounded by the inlet port ring. It avoids electrical discharges between the working surface and sensitive test parts.

1.4.2.5 RC1000 Remote control

The RC1000 is a wireless remote control that allows to operate the UL5000 from distance up to 100 m. It provides the functions START, STOP/VENT, ZERO and speaker volume, and displays leak rate in bargraph or in chart mode. (see also Technical Handbook RC1000.)

Measured values can be stored in an internal memory for up to 24 hours of recording time. The data can easily be downloaded to a USB stick to save it.

An internal trigger can be set to provide a warning if the limit leak rates are exceeded. An optical warning is shown on the display and an acoustic warning signal is sounded on the integrated loudspeaker or the connected headphones.

The RC1000 remote control is housed in a robust housing to enable ergonomic working. Magnets on the underside of the unit enable it to be attached to horizontal or vertical metal surfaces.

The RC1000 also enables remote operation of the leak test device in question using a connection cable of up to 28 metres in length.



Fig. 1-3 RC1000WL wireless remote control

2 Installation

2.1 Transportation



Caution

The UL5000 is not equipped with any crane eyes and must therefore not be transported using lifting equipment.



Caution

The UL5000 must only be pushed along using the handle provided for this purpose. Don't use the handle to lift.



Caution

Your feet can be pinched.
Keep your feet away from the rollers.



Caution

Your feet can be run over.
Do not pull the unit, push it.



Caution

When transporting over longer distances the original packaging must be used. The castors must not be fixed when the UL5000 is shipped in a crate.

UL5000 with Triscroll TS 620

For transportation the chassis plate where the pump is mounted on has to be secured by a transportation fixing.

This transportation fixing consists of 2 screws at chassis of the UL5000 (one on each side).

To get access to these screws remove the side covers of the UL5000. There are orange labels on the bottom part pointing to the screws:



Fig. 2-1

For transportation fixing the screws are tightened to the chassis plate. For operation of the UL5000 the screws should be loosened.

To loosen the screws first loosen the counter nut that is accessible from underneath:

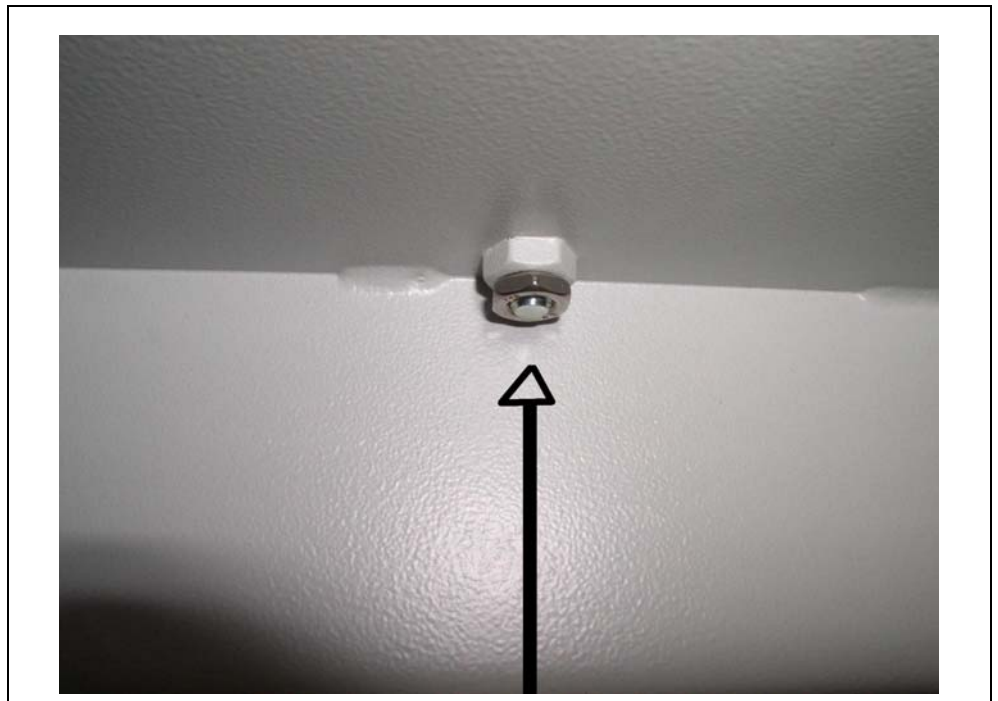

Fig. 2-2

Loosen the screws approximately 10 mm above the chassis plate and tighten then the counter nuts again:



Fig. 2-3

For transportation tighten the screws again and fix them by the counter nuts.

2.2 Working Location

Move the UL5000 to the desired position and arrest the castors.

Warning

The UL5000 is designed for indoor use only.

Caution

Ensure a sufficient air cooling. The air inlet as well as the air discharge openings must never be obstructed.

Caution

The UL5000 can be locked by arresting the castors of the front wheels to avoid movements on skewness.

Caution

Make sure that you can always reach the mains plug.

**Danger**

Caution: Exhaust gases and fumes:

Exhaust gases and fumes from oil-sealed pumps may be harmful to health.

For operation in poorly ventilated rooms, an exhaust pipe should be connected to exhaust connection 5 depending on the application and gases used.

It is recommended that you check all major helium sources in the vicinity of the UL5000 within a radius of about 10 m for the presence of any big leaks. You may use the sniffer probe for this.

2.3 Electrical Connections

2.3.1 Mains Power

Notice: Generally the local regulations for electrical connections must be observed.

**Danger**

Caution: mains voltage:

Improperly grounded or fused products can lead to fatal injuries.

The product must be connected in accordance with local regulations and properly grounded. Interruption of the ground conductor within or outside of the device is not permitted!

Only fuses of the specified type and rating are to be used as replacements.

**Warning**

Before connecting the UL5000 to the mains you must make sure that the mains voltage rating of the UL5000 coincides with the locally available mains voltage. The instrument must exclusively be connected to a single phase supply with fuses for installation (Circuit breaker 16A max. according to IEC/EN 60898-1 with tripping characteristic B).

The mains voltage rating for the UL5000 can be read off from the name plate beneath the mains socket [Fig. 2-6/7](#) at the back side. This voltage is fixed and can not be changed.

A separate fuse for each of the mains conductors has been integrated into the mains switch.

The mains voltage is applied to the instrument via the detachable mains cable which is supplied with the instrument. A mains socket [Fig. 2-6/7](#) is available for this purpose at the back side of the instrument.

STOP Danger

Only the 3-wire mains cables supplied by INFICON with connected protective conductors may be used. The UL5000 must not be operated without the earth conductor connected.

Warning

Pulling on the power cord may cause damage to the power outlet. The power cord can be secured against accidental unplugging.

- If someone intentionally or accidentally pulls the power cord
- when the device is being moved around
- or someone stumbles over the cable, the power outlet may be damaged.

Place the power cord so that no one can accidentally pull it or trip over it.

Tip The power cord can be secured against coming out by using the power cord fixture as shown:



Fig. 2-4. secure fixture power cord



Fig. 2-5. storing power cord

2.3.2 Connections for the Data Acquisition Systems

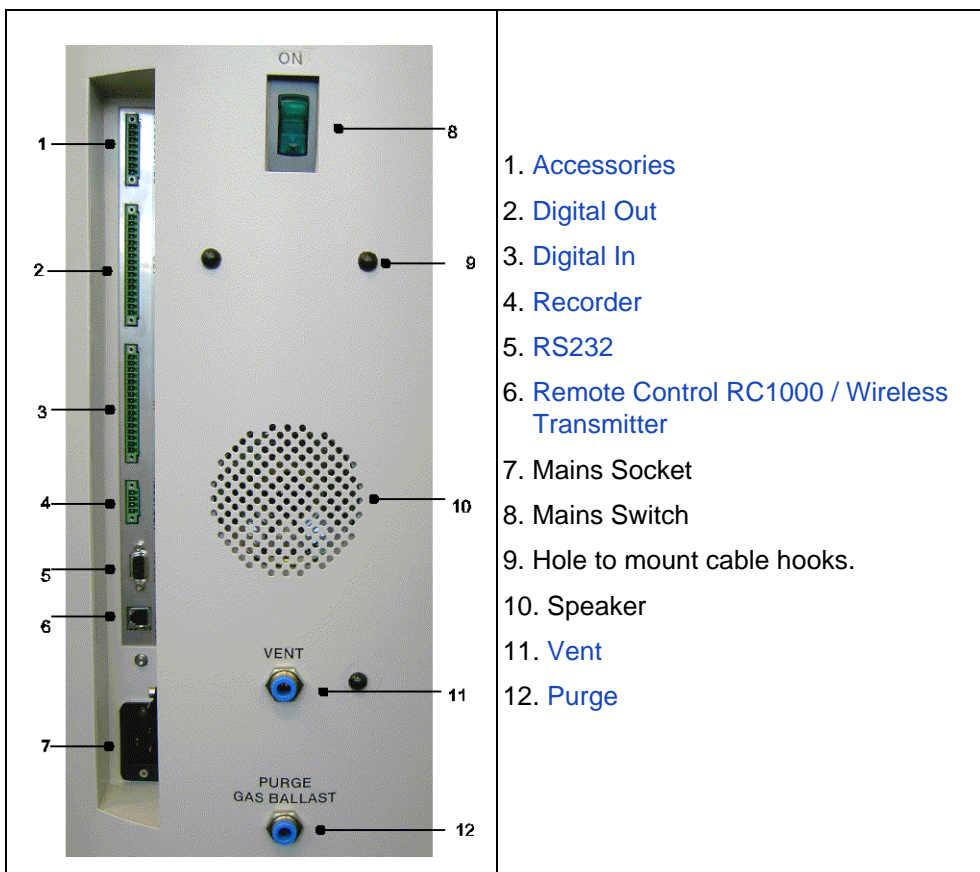



Fig. 2-6 Connections

Tip The sockets: Accessories, Digital Out, Digital In and Recorder have pin 1 on top. The pin numbers are counted downwards. The socket 2 and 3 are coded mechanically to avoid a confusion with the counter plug. For the connection with the counter plug (set of plugs 20099024) remove the plastic pins at the plug, accordingly the plug fits the socket.

Notice: The connections for external devices are safely separated from the mains and safe low voltage.

Caution

The electronic of the device can be destroyed. So just connect devices to the leak detector that are separated from the mains.

2.3.2.1 Accessories

The following accessories may be connected to this port [Fig. 2-6/1](#):

- external venting valve
- sniffer probe

Contact pins 1 and 3 are fused with a 0.8 A slow-blow fuse. The amount of power which can be drawn is limited to 10 W. The contacts are numbered from top to bottom.

| Pin | Assignment |
|------------|---|
| 1 | +24 V, constantly applied, power supply for the INFICON partial flow valve or sniffer line. |
| 2 | GND24 |
| 3, 6 | Input |
| 4, 5, 7, 8 | Output |

2.3.2.2 Digital Out

The following relay outputs are available for further signal processing.

Notice: Relay outputs (contact 3-12): Max. load 60 V DC / 25 V AC / 1 A ohmic load, for up to 500,000 switching operations.

Semiconductor relay outputs (contact 13, 14): max. load 30 V 1 A for frequent switching operations.

For frequent switching operations (more than 500,000 in the planned operating time), use only the semiconductor relay outputs.

| Pin | Assignment | Pin | Assignment |
|-----|---|-----|-----------------|
| 1 | +24V, bridged with pin 1 of socket „Digital In“ | 9 | CAL request |
| 2 | GND_24V | 10 | Error |
| 3 | Trigger 1 | 11 | Warning |
| 4 | Trigger 2 | 12 | Purge |
| 5 | Reserved | 13 | Measure |
| 6 | Zero active | 14 | Recorder Strobe |
| 7 | Ready | 15 | Common dig. out |
| 8 | CAL active | 16 | Reserved |

Description of the operation mode of the Digital Out.

Trigger 1:

Is open in case Trigger Level 1 is exceeded or the machine is not in condition of measuring.

Trigger 2:

Is open in case Trigger Level 2 is exceeded or the machine is not in condition of measuring.

Zero active:

Is closed in case Zero function is running.

Ready:

Is closed in case machine is ready for measurement (Emission on, no error).

CAL active

Closed when machine is in calibrating routine.

CAL Request

Is opened in case of calibration request. During external calibration an open output indicates that the external calibrated leak has to be closed.

Error

Open when an error is shown.

Warning

Open when a warning is shown.

Purge

Closed when purge is active.

Measure

Closed in case a machine is in measure mode.

Recorder Strobe

Closed in case recorder output is invalid. Only used when record output is set on „leak rate“.

2.3.2.3 Digital In

Caution

The electronics of the UL5000 ma be destroyed if teh input voltage is too high.
The input voltage must not exceed 30 V DC.

These inputs can be used to control the UL5000 with a programmable logic control (PLC).

| Pin | Assignment | Pin | Assignment |
|-----|--|-----|------------|
| 1 | +24V, bridged with pin 1 of socket „Digital Out“ | 8 | Purge |
| 2 | GND_24V | 9 | Reserved |
| 3 | Start | 10 | Reserved |
| 4 | Stop | 11 | Common dig |
| 5 | Zero | 15 | Reserved |
| 6 | CAL | 16 | Reserved |
| 7 | Clear | | |

Description of operation mode of the Digital In.

Zero:

Change from low to high: activate zero

Change from high to low: deactivate zero

Start:

Change from low to high: activate START

Stop:
 Change from low to high: activate STOP
 Additionally the inlet is vented, when this input is longer high than the specified vent delay.

Purge:
 Change from low to high: activate purge
 Change from high to low: deactivate purge

Clear:
 Change from low to high: confirm error message

CAL:
 Change from low to high:
 When machine is in stand-by mode: start internal calibration. In case machine is measurement mode: start external calibration. (Premise: external calibration test leak has to be open and leak rate signal is stable)
 Change from high to low:
 External calibration: approve that external test leak is closed and leak rate signal is stable.
 High means: $U > 13 \text{ V}$ (approximately 7mA)
 Low means: $U < 7 \text{ V}$
 The level of the logic signals must not exceed 35V.

Notice: Signals at these inputs are only accepted if the location of control is set to „PLC“ or „Local and PLC“. [6.6.4.2](#)

2.3.2.4 Recorder

The recorder output [Fig. 2-6/4](#) may be used to log the leak rate, the inlet pressure and the forevacuum pressure.

The measured values are provided by way of an analogue signal in the range of 0 V ... 10 V. The resolution is limited to 10 mV. The recorder output may only be loaded with a maximum of 1 mA. The reference potential (GND) is available at pins 2 and 3. The contacts are numbered from top to bottom.

Notice: A diagramm showing pressures and leakrate versus voltage is attached in the appendix.

Notice: The chart recorder outputs are electrically isolated from other plugs. If, in spite of this, hum interference is apparent it is recommended to operate the UL5000 and the chart recorder from the same mains phase. If this is not possible, you must make sure that the frame ground of both instruments is kept at the same potential.

| Pin | Assignment |
|-----|------------|
| 1 | Analog 1 |
| 2 | GND |
| 3 | GND |
| 4 | Analog 2 |

2.3.2.5 RS232

This RS232 C interface [Fig. 2-6/5](#) is wired as data communication equipment (DCE) and permits the connection of a personal computer (PC) for monitoring and data logging. The connection is made through a 9 pin sub-D socket.

| Pin | Assignment |
|-----|------------|
| 2 | RXD |
| 3 | TXD |
| 5 | GND |
| 7 | RTS |
| 8 | CTS |

2.3.2.6 Remote Control RC1000 / Wireless Transmitter

This Remote Control interface [Fig. 2-6/6](#) is a serial interface to control the UL5000 by the RC1000. The RC1000 Remote Control can be connected via the wireless transmitter or via an extension cable with a RJ45 plug. Refer to the RC1000 Technical Handbook for more information.

| Pin | Assignment |
|-----|----------------------------|
| 2 | +24V (fuse 0.8 A time lag) |
| 3 | 0 V |
| 4 | RXD (intern. RS232) |
| 5 | TXD (intern. RS232) |

2.4 Vacuum Connections

2.4.1 Inlet Port

The inlet port is located on the top of the UL5000. The size of the flange is DN 25 KF.



Warning

Risk of injury due to sucking connection flange (inlet port).
If the Vacuum-Mode of the UL5000 is activated, the connection flange may suck bodily parts around the connection flange.
Keep bodily parts off the connection flange.

A test object or a test chamber has to be connected to the inlet port if the vacuum mode is chosen (Refer to Chapter 6.3).

The inlet port is also used for the connection of the sniffer line.

2.4.2 Exhaust

The exhaust Fig. 2-6/12 flange is located underneath the UL5000 at the back side. The size of the flange is DN 16 KF.

When shipped only the exhaust filter body is preassembled. The filter cartridge is supplied together with the leak detector and can be installed at the exhaust.

Instead of this an exhaust line can be connected to the exhaust by the exhaust adapter.



Warning

Depending on the chamber the UL5000 is attached to and the gas inside the chamber lethal gases can be spoiled into the air through the exhaust.

2.4.3 Vent

Usually the parts under test are vented with ambient air when the test is finished. If it is required the parts can be vented with a different gas (i. e. fresh air, dry air, nitrogen, ...) at max. 1050 mbar pressure. In this case a vent hose has to be connected to the hose coupling Fig. 2-6/10.

2.4.4 Purge

For purge modes it is recommended to use Helium-free gases at atmospheric pressure. Ambient air can be contaminated with Helium due to spraying or charging. In this case a gas supply line (i. e. nitrogen, fresh air, ...) should be connected to the hose coupling Fig. 2-6/11. *The pressure of these gas line must not exceed 1050 mbar.*

The connector 10 and 11 in Fig. 2-6 are quick connectors for hose diameters of 8/6 mm.

2.5 Default parameters

The following parameters are set like shown when in the menu of the UL5000 under Settings → Parameters save/load, „load default values“ is chosen.

| | |
|---|-----------------------------|
| Auto-scaling: | On |
| Scaling | logarithmic |
| Display range: | 4 decades |
| Time axis: | 32 seconds |
| LCD invers: | OFF |
| Background in stand by mode: | OFF |
| Automatic calibration request: | OFF |
| Mass: | 4 (helium) |
| Recorder Output: | leak rate |
| Volume: | 2 |
| Zero time: | 5 seconds |
| Leak rate unit: | mbar l/s |
| Mode: | Vacuum with HYDRO•S |
| Trigger level 1: | 1×10^{-9} mbar l/s |
| Trigger level 2: | 1×10^{-8} mbar l/s |
| Leak rate external test leak (Vacuum): | 1×10^{-7} mbar l/s |
| Leak rate external test leak (Sniffer): | 1×10^{-5} mbar l/s |
| Vent delay: | 2 seconds |
| Automatic purge: | OFF |
| Pressure unit: | mbar |
| Minimum volume: | 0 |
| Beep: | ON |
| Maximum evacuation time: | 30 minutes |
| Audio Alarm Type: | Trigger Alarm |
| Maximum inlet pressure when sniffing: | 1 mbar |
| Minimum Inlet pressure when sniffing: | 0,1 mbar |
| Number of decimal place at leak rate displayed: | 1 |
| Scroll display: | On |
| Particle protection: | Off |
| Direct access to calibration: | On |
| Contamination protection: | Off |
| Switch off limit for contamination protection: | 1E-3 mbar l/s |
| Control location: | Local |
| Alarm delay: | 30 seconds |
| Leak rate filter: | l•Cal |
| Zero: | enable |
| HYDRO•S automatic | enabled |

3 First Operation Check

The steps for an initial operation are described in this chapter. It is explained how to switch on the UL5000, how to measure and how to carry out an internal calibration.

Notice: If anything unexpected happens during the initial operation or the leak detector acts in a strange way the UL5000 can be switched off by the mains switch at any time.

3.1 Needed Equipment

The following parts will be needed:

- A blind flange 40 KF (if not preassembled at the inlet port).
- A helium test leak with a DN 40 KF adapter (optional).

3.2 Description of the Initial Operation

Please proceed the following description step by step to start the initial operation. See Chapter 5 for a more detailed description.

3.2.1 Startup and Measure

- 1 Unpack the UL5000 and inspect it for any external damage (See Chapter 1.4 [Unpacking](#)).
- 2 Connect the instrument to the mains power (See Chapter 2.3.1 [Mains Power](#)).
- 3 Switch on the leak detector by using the mains switch [Fig. 2-6/8](#).



Warning

Caution: Abrupt movements.
Abrupt movements can damage the running turbo pump.
Avoid abrupt movement and vibration of the instrument (e.g. running over cables, door sills) during operation and up to 4 minutes after switching off since the turbo pump can be damaged.



Caution

Don't switch machine on when ambient temperature is below 10°C.

After power on a welcoming picture appears on the screen of the control panel [Fig. 3-1/1](#), then status information on the speed of the turbo pump, the foreline pressure, the emission and the active filament are given.

The start up procedure takes about 4 minutes and the end is indicated by a beep. The UL5000 is in Stand-by mode now.



Fig. 3-1: Top view of the UL5000

| Pos. | Description | Pos. | Description |
|------|---------------|------|-------------|
| 1 | Control Panel | 2 | Inlet Port |

- 4** Check if the inlet port [Fig. 3-1/2](#) is blanked off. If not, please mount a blind flange with O-Ring on the inlet port.
- 5** Press the [START Button Fig. 3-2/6](#). The inlet will be evacuated and the measured leak rate will be displayed a moment later.

This is the measurement mode. If a test part was connected you would start spraying Helium to identify leaks.



Fig. 3-2: Control Panel

| Pos. | Description | Pos. | Description |
|------|----------------|------|----------------|
| 1 | LC Display | 8 | Soft Key no. 5 |
| 2 | Soft Key no. 1 | 9 | Soft Key no. 6 |
| 3 | Soft Key no. 2 | 10 | Soft Key no. 7 |
| 4 | Soft Key no. 3 | 11 | Soft Key no. 8 |
| 5 | Soft Key no. 4 | 12 | MENU Button |
| 6 | START Button | 13 | STOP Button |
| 7 | Control Panel | 14 | ZERO Button |

- 6** To correct for any background signal (residual Helium in the part under test) you may press the **ZERO Button Fig. 3-2/14**. To undo **ZERO** please press the **ZERO Button** for 2 ... 3 seconds.
- 7** Press the **STOP Button Fig. 3-2/13**, the UL5000 will go to Stand-by. If you press **STOP** a few seconds the inlet of the UL5000 will be vented.
- 8** To finish the startup procedure please proceed with #16. For calibration proceed with #9.

3.2.2 Internal Calibration

- 9** Proceed the internal calibration (See Chapter [7.2.1 Internal Calibration](#)). For better quantitative measurements please allow the unit to warm up (15 ... 20 minutes).
 - Press **Calibration** (Soft Key no. 5 [Fig. 3-2/8](#)) to get into the calibration menu.
 - Select *internal* (Soft Key no. 4 [Fig. 3-2/5](#)) to choose the internal calibration.
 - Select *automatic* (Soft Key no. 8 [Fig. 3-2/11](#)). The automatic procedure of the internal calibration is started and takes about 30 seconds.
- 10** Press the **STOP Button** [Fig. 3-2/13](#) until the message *STAND-BY/VENTED* appears on the display. The inlet is vented now.

3.2.3 Verification

To verify the accuracy please proceed through the following steps. A test leak is required. If a test leak is not available please continue with #16.

- 11** Remove the blind flange from the inlet port and connect the open helium test leak to the inlet port.
- 12** Press the **START Button** [Fig. 3-2/6](#) again. The inlet will be evacuated and the leak rate of the test leak will be measured and displayed.
- 13** Press the **STOP Button** [Fig. 3-2/13](#) to interrupt the measurement. The Stand-by mode will be displayed.
- 14** Press the **STOP Button** [Fig. 3-2/13](#) again until the message *STAND-BY vented* appears on the display. The inlet is vented now.
- 15** Remove the helium test leak from the inlet port and put a blind flange onto the inlet port again.
- 16** Switch off the leak detector by using the mains switch [Fig. 2-6/8](#).
The first operation is finished.

4 Description and Working Principle

4.1 Introduction

The UL5000 basically is a helium leak detector for vacuum applications, i.e. the part under test is evacuated while the test is performed. The vacuum is achieved with a pumping system that is part of the UL5000. In addition the vacuum can be generated by pumps with are set up in parallel to the leak detector.

Another operating mode of the UL5000 is the Sniff mode which can only be used when a sniffer line (See Chapter 1.4.2 Accessories and Options) is hooked up.

4.2 Components of the UL5000

The UL5000 is a self-contained unit in a metal housing on wheels. This housing contains the entire vacuum system and the according power supplies. On top of the unit is the inlet port and the display.

4.2.1 Vacuum System

The vacuum diagram below shows the major components inside the UL5000:

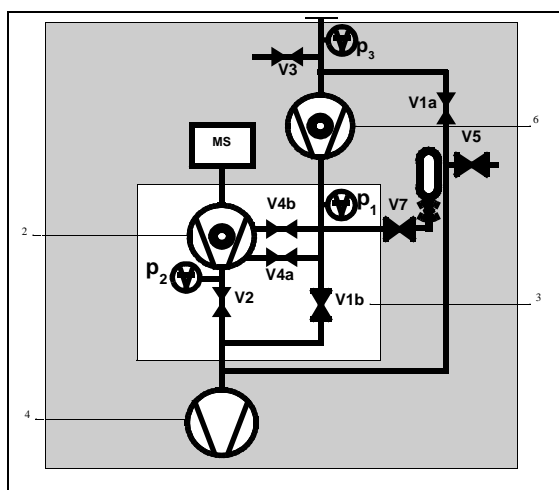

Fig. 4-1: Vacuum diagram UL5000

- | Pos. | Description |
|------|--|
| 1 | MS: Mass Spectrometer, Helium sensor (180° magnetic field mass spectrometer) |
| 2 | Turbomolecular Pump (TMP, provides high vacuum conditions in the MS) |
| 3 | V1a ... V8: Electromagnetic Valves to control the gas flows |
| 4 | Scroll pump (provides the foreline pressure for the TMP and pumps down the parts under test) |
| 5 | Inlet Port |
| 6 | Booster Turbomolecular pump |

The mass spectrometer is mainly composed of the ion source, the magnetic separator and the ion collector.

Gas molecules getting into the mass spectrometer are ionized by the ion source. These positively charged particles are accelerated into the magnetic field following a circular path, the radius of which depends on the mass-to-charge ratio of the ions. Only helium ions can pass this filter and reach the ion collector where the stream of the ions is measured as a electrical current.

For operation the mass spectrometer requires a vacuum level in the range of 1×10^{-4} mbar and lower. This pressure is provided by the turbomolecular pump which in turn is backed up by a scroll pump.

Besides maintaining the pressure in the mass spectrometer the pump system is used to evacuate the test parts. It is made sure that the pressure in the mass spectrometer is low enough under all circumstances. The valves V1a, V1b, V2, V4a, V4b control the gas flows when measuring. Valves V5, and V8 are used to vent the system and the Turbo pump. Valve V7 opens and closes the internal test leak during calibration.

With the pressure in the test part being lower than ambient pressure sprayed helium can penetrate into the part in case of a leakage. As soon as the pressure conditions allow it one of the valves to the TMP opens. Now Helium can penetrate into the mass spectrometer contrary to the pumping direction of the TMP.

See Chapter [4.3 Working Modes](#) for details.

4.2.2 Control Panel

The **Control Panel** Fig. 4-2/7 contains a liquid crystal display (LC Display), the **START**, **STOP**, **ZERO** and **MENU** buttons and also eight Soft Keys for the different menus and inputs.

The control panel itself is rotatable.

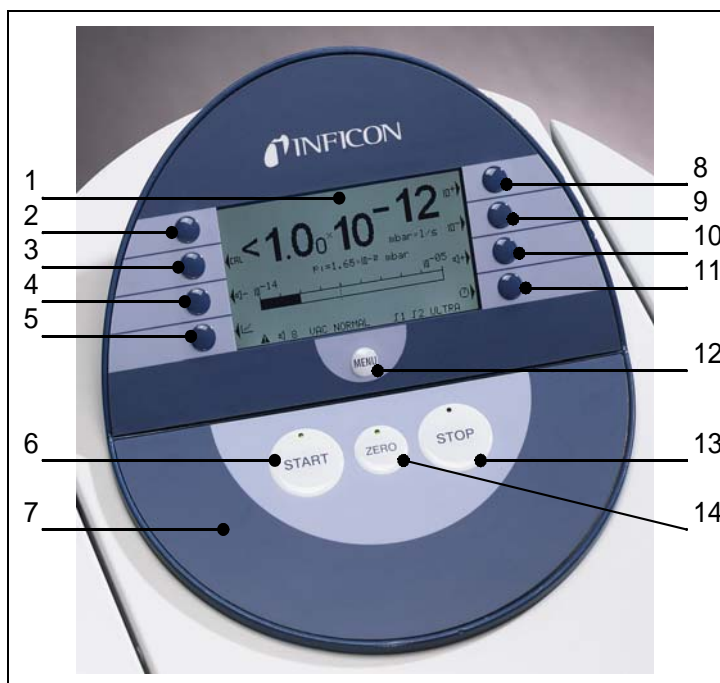

Fig. 4-2: Control Panel

| Pos. | Description | Pos. | Description |
|------|----------------|------|----------------|
| 1 | LC Display | 8 | Soft Key no. 5 |
| 2 | Soft Key no. 1 | 9 | Soft Key no. 6 |
| 3 | Soft Key no. 2 | 10 | Soft Key no. 7 |
| 4 | Soft Key no. 3 | 11 | Soft Key no. 8 |
| 5 | Soft Key no. 4 | 12 | MENU Button |
| 6 | START Button | 13 | STOP Button |
| 7 | Control Panel | 14 | ZERO Button |

4.2.2.1 LC Display

The **LC Display** Fig. 4-2/1 is the communication interface to the operator. It displays the leak rates, the status report of the machine, messages, warnings and errors.

4.2.2.2 START Button

Pushing the **START Button** Fig. 4-2/6 enables the UL5000 to start the measure procedure. If the START button is pushed again in measurement mode, the maximum leak rate indicator („hold“ function) is activated. This indicator shows the maximum leak rate between „START“ and next „STOP“

4.2.2.3 STOP Button

Pushing the **STOP Button** Fig. 4-2/13 interrupts the measure procedure. If the button is pressed longer the inlet is vented according to the conditions defined in the menu **Vent delay**. See Chapter 6.6.1.2 **Vent delay** to select the time parameters of the venting.

4.2.2.4 ZERO Button

Pushing the **ZERO Button** Fig. 4-2/14 enables the zero mode.

When pressing ZERO the currently measured leak rate is taken as a background signal and is subtracted from all further measurements. As a result the displayed leak rate then is

- 1×10^{-6} in *GROSS*
- 1×10^{-10} in *FINE*
- 1×10^{-12} in *ULTRA*

To reverse the ZERO function please keep the push button pressed for about 3 seconds.

After pressing ZERO the decreasing background is fitted to the course automatically. So it is possible to recognize leaks even when the signal is decreasing rapidly.

Please also refer to the pictures below.

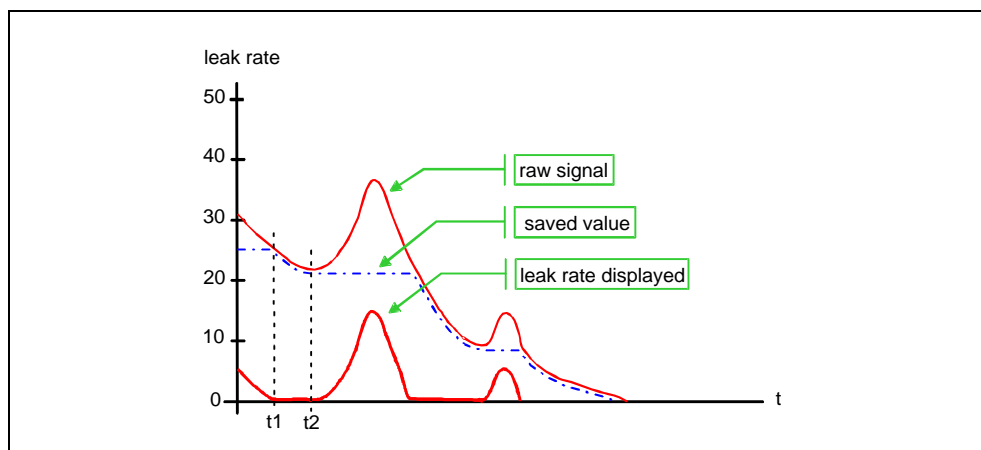

Fig. 4-3 decreasing background

When the raw signal declines below the saved background value the background value will automatically be equated with the raw signal. As soon as the raw signal is increasing again the saved decreasing value remains constant. Increasing of the signal are displayed clearly as a leak.

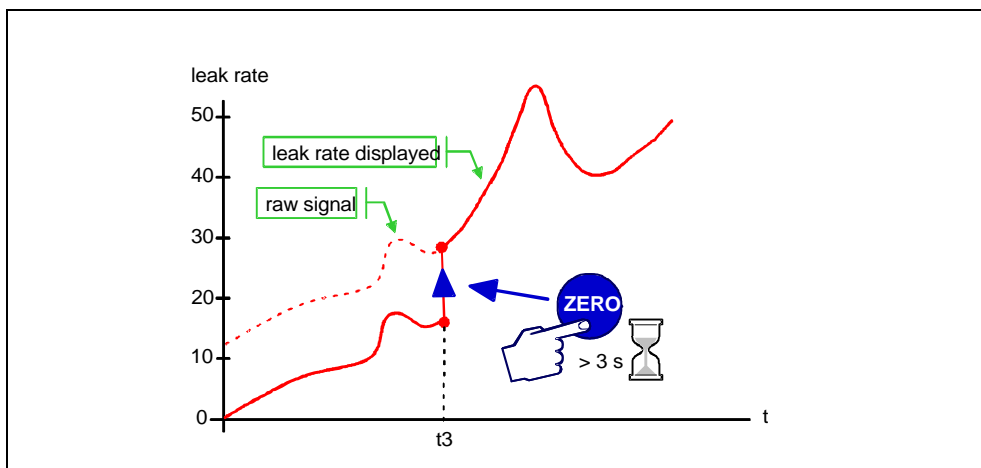

Fig. 4-4 undo zero

When you want to see the raw signal (including underground) please press the ZERO button about 3 seconds. The saved value will be reset to zero. The underground signal will not be suppressed anymore.

The ZERO function can be selected to a special mode that allows to use it only when the signal of a falling background becomes stable (see Chapter 6.6.2.3)

4.2.2.5 MENU Button

The menu appears on the LC Display after pushing the Fig. 4-2/12 during any working mode.

If the menu is opened during the current session the operator will lead to the last screen before the menu was left.

Pushing the MENU button again leads back to the screen of the previous working mode. The software shows the last screen that was used before.

4.2.2.6 Soft Keys

The function of the eight Soft Keys Fig. 4-2/2 ... /5 and /8 ... /11 depends on the current menu. Only key 1 and 8 very often have the functions *Back/Cancel* (Softkey no. 1) and *OK* (Softkey no. 8.).

Special Functions

When inputs are allowed or when settings can be selected in a submenu two of the Soft Keys always have the same function:

- Soft Keys no. 1 Fig. 4-2/2 is *Cancel*.
It allows to escape from the submenu without any changes of the present settings and return to the previous menu page.
- Soft Keys no. 8 Fig. 4-2/11 is *OK*.
The selected settings or edited values will be stored and the previous menu page will be displayed again.

4.2.2.7 Numerical Entries

If you have opened a menu page where a number can be changed please proceed in the following way:

- If you don't want to change anything, press Soft Key no. 1 *Cancel*.
- The digit that can be changed is displayed inverted. With the arrows → (Soft Key no. 8) and ← (Soft Key no. 4) you can choose which digit you need to change.
- To change a digit to a specific number press the corresponding pair of numbers. A submenu opens and the desired number can be selected. The submenu closes automatically and the next digit of the total number now is inverted.
- Having reached the last digit all corrections have to be confirmed by *OK* (Soft Key no. 8).

Example

To change the trigger level 5.0×10^{-9} mbar l/s to 3×10^{-9} mbar l/s please press 2/3 (Soft Key no. 3) Fig. 4-5.

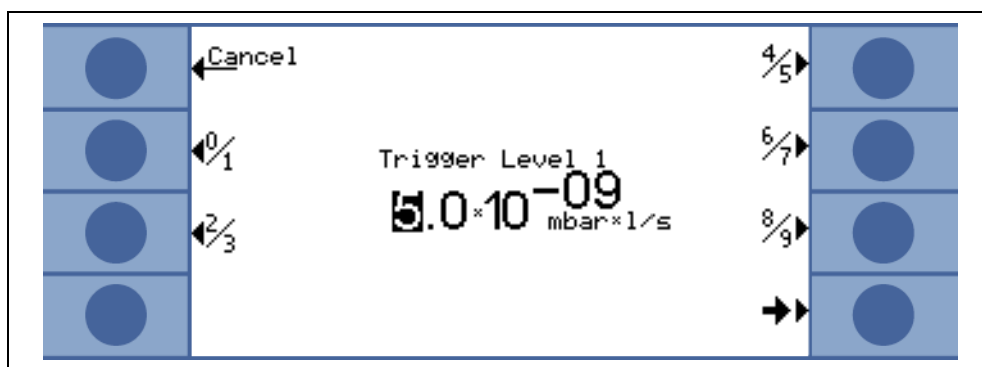

Fig. 4-5: Numerical entry of the [Trigger Level 1](#)

In the submenu press 3 (Soft Key no. 4) Fig. 4-6.

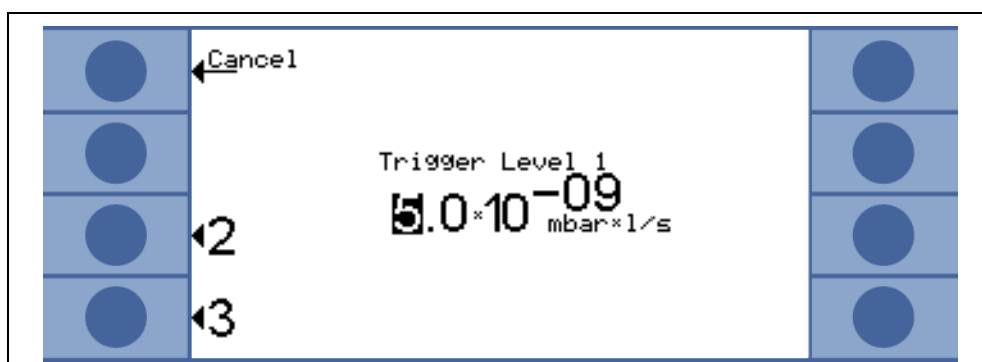

Fig. 4-6: Submenu of the [Numerical Entries](#) (Example)

4.3 Working Modes

4.3.1 Vacuum Mode

As mentioned (See Chapter 4.2.1 Vacuum System) the sample has to be evacuated to allow Helium which is sprayed on the outside to enter through any leaks due to the pressure difference.

When pressing the **START Button** Valves V1a and V1b open and the sample is pumped down by the scroll pump. The booster turbo pump starts. At the same time valve V2 is closed to avoid an unacceptable pressure increase in the turbo pump and the mass spectrometer. With valve V2 being closed the turbomolecular pump is operated without being backed up by the scroll pump. Since the mass spectrometer is already under vacuum no further gas is pumped. Thus the pressure p_2 remains constant or increases only slowly.

The following diagrams show the gas flow during evacuation and during the modes GROSS, FINE and ULTRA.

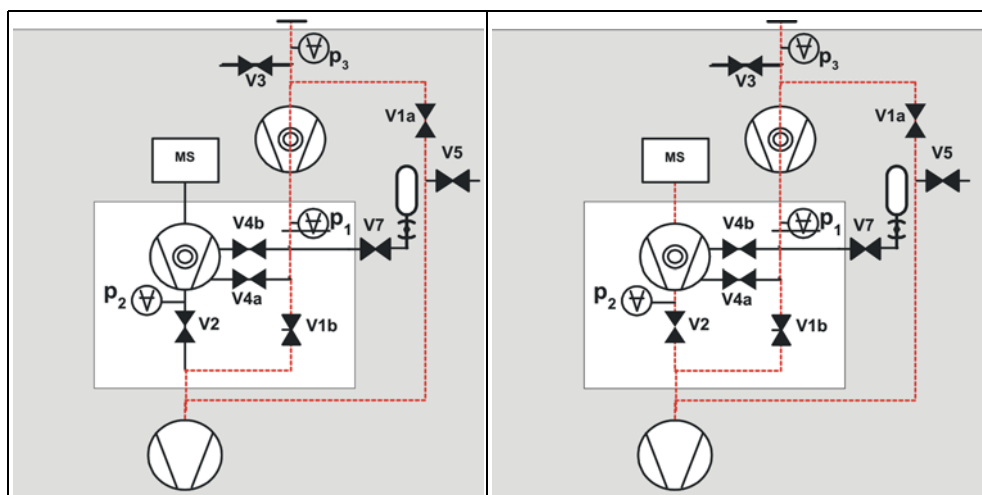

Fig. 4-7: left: Evacuation (no measurement), right: GROSS Mode

The condition for the evacuation process described is maintained until the inlet pressure p_1 has dropped below 15 mbar. Now valve V2 opens. Possibly present helium may now flow upstream against the pumping direction of the turbo molecular pump into the mass spectrometer where it is detected. This mode is called GROSS, the detection limit is 1×10^{-7} mbar l/s. At 1 mbar the booster turbo pump becomes effective.

Since the scroll pump continues to evacuate the test sample the inlet pressure p_1 will continue to drop. Below 2 mbar the UL5000 will switch to FINE mode, i.e. V1a and V4a will open and valve V1b will close. The gas stream enters the turbo pump at an intermediate level. The sensitivity of the system now is higher, the detection limit is 1×10^{-10} mbar l/s.

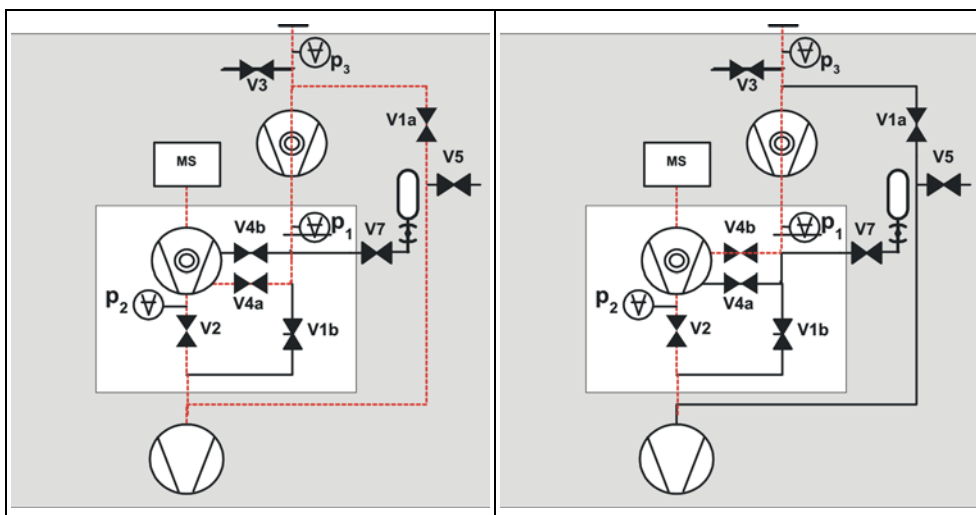

Fig. 4-8: left: FINE Mode, right: ULTRA Mode

Now the lower part of the turbo pump further evacuates the sample and after the pressure p_1 has reduced below 0.4 mbar the UL5000 switches into ULTRA mode, i.e. V1a and V4a close and V4b opens. The entrance into the turbo pump is on a higher level now. The pumping speed at the inlet port is now 20 l/s, the detection limit is $<5 \times 10^{-12}$ mbar l/s.

Tip A special set up of the UL5000 stops the autoranging procedure as described above. With the mode *Gross only* (See Chapter 6.3 Mode) the unit will stay in GROSS Mode Fig. 4-7 (right) regardless the inlet pressure.

4.3.2 Sniffer Mode

In sniff mode a sniffer line (preferably the INFICON standard sniffer line 14005) is connected to the inlet port. When pressing the **START Button** the system starts to pump air through the sniffer line. Due to the constant gas flow through the sniffer line the software will range through GROSS into FINE mode and stay there. The inlet pressure will not drop further down. By measuring the inlet pressure the system software makes sure that the flow through the sniffer line is at the right level. Otherwise warning messages are generated. The detection limit in sniff mode is $<1 \times 10^{-7}$ mbar l/s.

INFICON's sniffersystem QT100 may also be used to sniff. Since the QT100 provides a lower inlet pressure it is recommended to keep the system in vacuum mode to avoid a wrong generation of pressure warnings.

5 Operation of the UL5000

The UL5000 is switched on by pushing the mains switch (See Chapter 3.2.1 [Startup and Measure](#)). After about 2.5 min the run-up procedure is finished; the unit is in Stand-by-mode and ready to measure.

Please connect the part to be tested to the inlet port and press *START*. The UL5000 starts to evacuate the part. The evacuation time depends on the volume of the test part. During evacuation the screen shows the inlet pressure online.

Once the pressure of 15 mbar (11 Torr or 1500 Pa) is reached the unit switches to measurement mode. The corresponding leak rate is displayed. For further explanations of the screen please refer to [Fig. 5-1](#).

The displayed leak rate corresponds to the helium background concentration in the part under test. Since the UL5000 continues to pump down the part this background leak rate will further reduce. As soon as the leak rate is low enough in respect to your requirements you may start spraying Helium to search for possible leaks.

When you are finished please press *STOP* and hold the button a few seconds to vent the part under test.

5.1 Display

The display is used to either show leak rate signals or program specific set-ups and get information by means of the software menu (See Chapter 6 [Description of the Menu](#)). In addition messages and maintenance instructions are displayed on the screen (See Chapter 8 [Error And Warning Messages](#)).

5.2 The Screen in Run-Up Mode

In run-up mode the display shows:

- Speed of the turbo molecular pump
- Foreline pressure
- State of emission
- Active filament
- A bar graph which shows the run-up progress

Notice: If the display is too bright or too dark, please refer to Chapter 6.2.4.

5.3 Display in stand-by mode

In stand by mode the states are shown in the lower edge of the display (See Chapter 5.4.3). Furthermore calibration (See Chapter 7) can also be started in stand by mode and purging, too (See Chapter 5.3.1).

5.3.1 Purging

Every time when the UL5000 changes into stand by mode it starts purging automatically after 20 seconds. During this purging the scroll pump is flushed through purge connection (See Fig. 2-1/11).

When the machine is in stand by mode this operation also can be activated manually (Key 7). By pressing the key again the purging will be discontinued. By pressing START the activity will be discontinued, too.

5.4 The Screen in Measurement Mode

In measurement mode the leak rates can be displayed in two different modes:

- Numerically, combined with a bargraph Fig. 5-1
- Trend mode (leak rate versus time) Fig. 5-2

In the lower right corner of the display (next to the Soft Key no. 8) you will find a symbol that allows to switch between the display modes by pressing Soft Key no. 8. See Chapter 5.4.4 Numerical Display Mode and refer to chapter 5.4.5 for explanations of the different display modes.

Access to calibration (Soft Key no. 5) and access to the speaker volume (Soft Keys no. 2 and no. 3) is the same in all modes. Also the status icons in the bottom line are in common in all display modes.

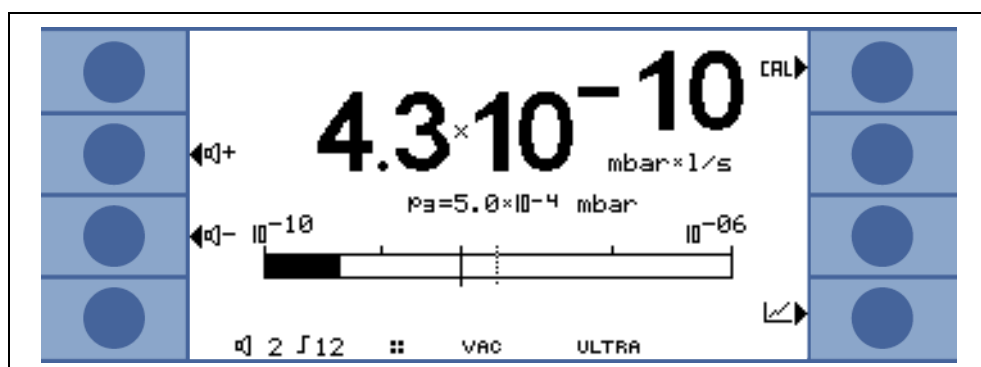

Fig. 5-1: Display, measurement mode

5.4.1 Call for Calibration

In all modes the Soft Key no. 5 is used to get to the calibration routine. See Chapter 7 Calibration for further information regarding calibration.

5.4.2 Speaker Volume

Danger

The hearing can be harmed by the audio alarm.
The acoustic output can exceed a level of 85dB(A).
Do only expose to the audio alarm for a short time or use ear protection.

On the left hand side two loud speaker symbols are shown, combined with the signs + and -. By pressing the corresponding softkeys (Soft Keys no. 2 and no. 3) the volume can be adjusted for convenient loudness. In the bottom line of the display another loud speaker symbol is shown, combined with a number. This number indicates the level of the current loudness (ranges from 0 to 15).

See Chapter [6.4.3 Volume](#) for information on loudness, alarms, and sound tracks.

5.4.3 Status Line in the Display

The status line at the bottom of the display informs about (reading from left to right):

| <i>Symbol of display</i> | <i>Meaning</i> | <i>Explanation</i> |
|--------------------------|--|--|
| | <ul style="list-style-type: none"> Volume level | See Chapter 5.4.2 Speaker Volume . |
| S1 | <ul style="list-style-type: none"> Trigger 1 | If the trigger values are exceeded these signs are inverted. (White on black background.) |
| S2 | <ul style="list-style-type: none"> Trigger 2 | see: Trigger 1 |
| •• | <ul style="list-style-type: none"> Detected mass | Number of dots indicates the mass number (4 dots = Helium, 2 dots = Hydrogen) |
| | <ul style="list-style-type: none"> Warning triangle | See Chapter 8.1 |
| VAC | <ul style="list-style-type: none"> Working mode | VAC or <i>SNIFF</i> indicate which working mode was selected (see Chapter 6.3 Mode). |
| ULTRA | <ul style="list-style-type: none"> GROSS/FINE/ULTRA | Depending on the inlet pressure the UL5000 may be in GROSS, FINE or ULTRA, which is indicated here (see Chapter 4.3 Working Modes). |
| ZERO | <ul style="list-style-type: none"> ZERO | Indicates if ZERO-function is active. |
| HYDRO•S | <ul style="list-style-type: none"> HYDRO•S | Indicates if HYDRO•S function is active. See Chapter 5.4.6 . |
| I•ZERO | <ul style="list-style-type: none"> I•ZERO | Indicates if I•ZERO function is active. |
| STABLE | <ul style="list-style-type: none"> Signal stable | Indicates if background signal is stable (see Chapter 6.6.2.3). |

5.4.4 Numerical Display Mode

The display shows the leak rate in big digital figures, see Fig. 5-1. The unit of the leak rate is shown, too. Underneath the leak rate the inlet pressure is displayed in smaller digits. The units of leak rate and pressure can be defined in the menu (See Chapter 6.4.4 Units).

Below this the same leak rate is shown graphically as a bar. The scale of this bar, i.e. the number of decades included in this bar can be defined in the menu (See Chapter 6.2.2 Display-range auto/manual). The programmed trigger levels (See Chapter 6.4.1 and 6.4.2) are indicated at the bar by short vertical lines: a solid line for trigger 1 and a dotted line for trigger 2.

In addition the inlet pressure is displayed in smaller figures above the bargraph.

5.4.5 Trend Mode

In trend mode the leak rates are displayed over time Fig. 5-2. In addition the actual leak rate and inlet pressure also are displayed digitally. The time axis can be defined in the menu (See Chapter 6.2.3). The intensity axis (y-axis) is defined the same way as the bargraph (Please refer to Chapter 6.2.1 ff).

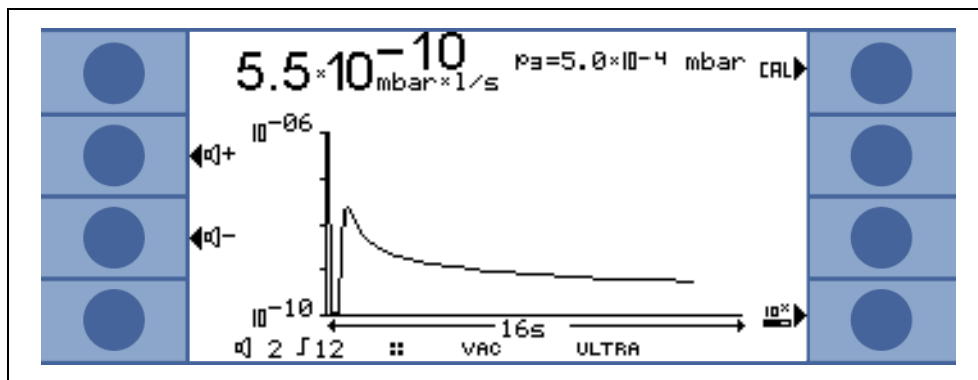

Fig. 5-2: Display, trend mode

5.4.6 HYDRO•S on / off

If working mode is set to „Vacuum: HYDRO•S: automatic ON or automatic OFF“ (See Chapter 6.3) you can switch HYDRO•S on or off with softkey 4. If HYDRO•S is on, the status line indicates „HYDRO•S“, if HYDRO•S is off, the status line indicates „VAC“. Also refer to Chapter 6.6.1.4

Notice: In the HYDRO•S mode the lower detection limit is 1×10^{-10} mbar l/s

6 Description of the Menu

By pressing the MENU push button Fig. 6-1 the main menu will be displayed regardless of the current working mode.

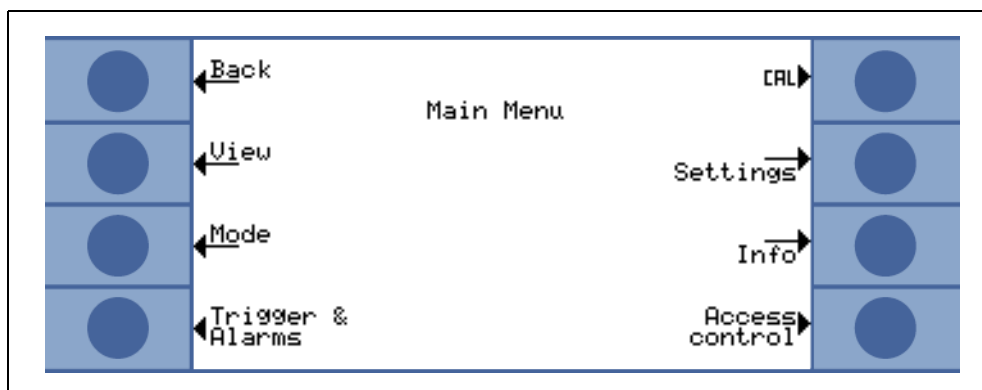

Fig. 6-1: The Main Menu

The main menu Fig. 6-1 leads the operator to several submenus described in the following chapters.

6.1 Main Menu

The main menu shows 7 sub-menus. In these sub-menus groups of technical features are put together logically. From here the next levels of the menu tree can be reached.

Tip All following chapters show the path to get to the described menu line right underneath the headline. This path is indicated by a dot (•) and printed in italics.

| Key No. | Name | Description |
|---------|-----------------------------|--|
| 1 | Back | Return to the previous screen. |
| 2 | <i>View</i> | Display settings like scaling, contrast, system background. Please refer to Chapter 6.2. |
| 3 | <i>Mode</i> | Selection of different working modes like Vacuum, Gross only, Sniff Please refer to Chapter 6.3. |
| 4 | <i>Trigger & Alarms</i> | Settings of units, trigger levels and alarms. Please refer to Chapter 6.4. |
| 5 | <i>Calibration</i> | Calibration of the UL5000. Please refer to Chapter 6.5. |
| 6 | <i>Settings</i> | Settings of internal machine parameters. Please refer to Chapter 6.6. |
| 7 | <i>Information</i> | Information on the UL5000 (electrical and vacuum data) and service menu. Please refer to Chapter 6.7. |
| 8 | <i>Access Control</i> | Access restrictions. Please refer to Chapter 6.8. |

The next page gives an overview of the entire menu architecture Fig. 6-2.

| 1. Level | | 2. Level | | 3. Level | |
|--------------------------|-----------------------------------|---------------------------------|---------------------------------|----------|--|
| Main Menu | View (See 6.2) | Scale linear/logarithmic | | | |
| | | Display-range auto/manual | | | |
| | | Time axis | | | |
| | | Contrast | | | |
| | | Background in Stand-by | | | |
| | | Decimal places | | | |
| | | Lower display limit | | | |
| | Mode (See 6.3) | Sniff/Vacuum | | | |
| | Trigger & Alarms (See 6.4) | Trigger Level 1 | | | |
| | | Trigger Level 2 | | | |
| | | Volume | | | |
| | | Units | | | |
| | | Alarm delay | | | |
| | | Audio alarm type | | | |
| | Calibration (See 6.5) | internal | manual | | |
| | | | automatic | | |
| | | external | Edit leakrate | | |
| | Settings (See 6.6) | Vacuum settings | Start | | |
| | | | Automatic purge | | |
| | | | Vent delay | | |
| | | | HYDRO•S | | |
| | | | Vacuum ranges | | |
| | | | Leak rate internal test leak | | |
| | | | Machine factor | | |
| | | | Booster TMP mode | | |
| | | Zero & Background | Background Suppression | | |
| | | | Calculate Inlet Area Background | | |
| | | | Zero | | |
| | | Mass | | | |
| | | Interfaces | Control Location | | |
| | | | Recorder output | | |
| | | | RS232 Protocol | | |
| | | | Scaling Recorder Output | | |
| Miscellaneous | | Time&Date | | | |
| | | Language | | | |
| | | Leak rate filter | | | |
| | | Mains Frequency | | | |
| | | Service interval exhaust filter | | | |
| | | Service message exhaust filter | | | |
| Parameter save / load | | Save parameter set | | | |
| | | Load parameter set | | | |
| Monitoring functions | Calibration request | | | | |
| | Particle Protection | | | | |
| | Contamination protection | | | | |
| | Pressure limits for vacuum ranges | | | | |
| | Pressure limits for sniff mode | | | | |
| | Maximum evacuation time | | | | |
| Information (See 6.7) | View settings | | | | |
| | View internal data | | | | |
| | Vacuum diagram | | | | |
| | View error list | | | | |
| | Calibration history | | | | |
| | Calibration factors | | | | |
| | Service | | | | |
| Access Control (See 6.8) | Access to CAL function | | | | |
| | Change Device PIN | | | | |
| | Change Menu-PIN | | | | |

Fig. 6-2: Menu Structure overview

6.2 View

- [Main Menu > View](#)

In this menu [Fig. 6-3](#) all features that influence the way data are displayed are put together.

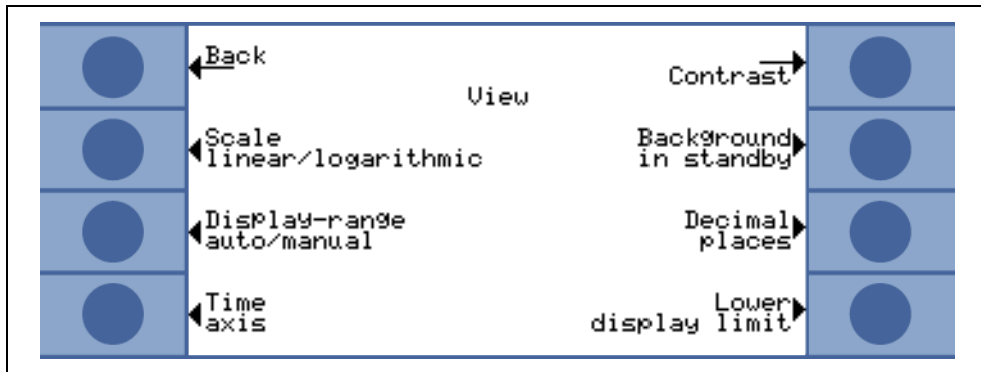

Fig. 6-3: The [View](#) Menu

| Key No. | Name | Description |
|---------|---|---|
| 1 | Back | Return to the main menu. |
| 2 | Scale linear/logarithmic | Settings for bargraph and trend mode. Please refer to Chapter 6.2.1 . |
| 3 | Display-range auto/manual | Manual or automatic scaling. Please refer to Chapter 6.2.2 |
| 4 | Time axis | Time axis in trend. Please refer to Chapter 6.2.3 |
| 5 | Contrast | Display contrast. Please refer to Chapter 6.2.4 |
| 6 | Background in Stand-by | Background displayed or not. Please refer to Chapter 6.2.5 |
| 7 | Decimal places | Number of decimal places. Please refer to Chapter 6.2.6 |
| 8 | Lower display limit | Please refer to Chapter 6.2.7 |

6.2.1 Scale linear/logarithmic

- [Main Menu > View > Scale linear/logarithmic](#)

These settings apply to the bargraph (= bar underneath the digital figures in the measurement mode) and Y-axis in the trend mode.

The scale of the bargraph can either be linear or logarithmic. With the arrows (up and down) it can be determined how many decades the bargraph covers.

Usually a logarithmic scale is recommended because leak rates may change easily over several decades.

Softkey 2: Linear

Pressing this key switches the display to a linear scale, starting at zero.

Softkey 6: Log

The scaling will be displayed logarithmically.

6.2.2 Display-range auto/manual

- [Main Menu](#) > [View](#) > [Display-range auto/manual](#)

The upper limit of the displayed leak rate range can be set manually or automatically. These settings apply to the bargraph (=bar underneath the digital figures in the measurement mode and y-axis in the trend mode).

With the upper limit defined here the lower limit is set to a value based on the number of decades (Please refer to Chapter 6.2.1).

Softkey 2: Manual

The upper limit of the displayed range can be set manually.

Softkey 3: Arrow down

.Decrease the upper limit if *manual* is chosen. The minimum value is 10^{-11} mbar l/s.

Softkey 6: Automatic

The limit of the displayed range will be chosen automatically.

Softkey 7: Arrow up

Increase the upper limit if *manual* is chosen. The maximum value is 10^{+3} mbar l/s.

Softkey 8:

Save the settings and return to the previous menu.

If linear scale is selected, the lower limit is always zero. The upper limit is only a default value. You can change this on the measurement screen with the Soft Key 6 and 7 if you have chosen manual display ranging.

6.2.3 Time axis

- [Main Menu](#) > [View](#) > [Time axis](#)

The length of the time axis in trend mode can be changed in steps of 16 ... 960 s.

Softkey 3: Arrow down

Decrease the length of the time axis. The minimum value is 16 seconds.

Softkey 4: Scroll on / off

In „scroll on“ the display is written continuously in trend mode. In „scroll off“ the display will be overwritten after the adjusted action is finished.

Softkey 5: ?

Help

Softkey 7: Arrow up

Increase the length of the time axis. The maximum adjustable value is 960 seconds.

6.2.4 Contrast

- [Main Menu](#) > [View](#) > [Contrast](#)

The contrast of the display can be changed. The changes are applied synchronously. The recommended value under regular conditions is 50 (or close to it).

Tip If by accident the display has been set too bright or too dark so that it can not be read off, this may be changed as follows:

Switch off the UL5000 and turn it on again. During the run-up phase press the key no. 3 or 7 so long until the display can be read properly again. This setting is saved to the EPROM only after confirming this through the contrast menu. If this setting is not confirmed, the former setting will be applied after switching on the instrument on again.

Softkey 3: Arrow down

Fade the contrast to dark. The minimum values is 0.

Softkey 4: Invert display

Invert the contrast of the screen.

Softkey 5: ?

Help

Softkey 7: Arrow up

Fade the contrast to light. The maximum value is 99.

6.2.5 Background in Stand-by

- [Main Menu](#) > [View](#) > [Background in Stand-by](#)

The internal background leak rate can be displayed in Stand-by mode (ON) or not (OFF). The default setting is OFF.

Softkey 3: Off

The background leak rate will not be shown.

Softkey 5: ?

Help

Softkey 7: ON

The background leak rate will be shown.

The internal background is generated by residual gas (e. g. helium) that has not been pumped away yet. Sources for residual gas are air or absorbed gases from the inner surfaces of the leak detector. This internal background will never disappear totally. Very clean systems which have been pumped for a long time will show a background in the 10^{-11} mbar l/s range. Under normal conditions the background level is in the 10^{-10} mbar l/s or low 10^{-9} mbar l/s range.

When pressing START the current internal background is subtracted from all further measured signals automatically. Thus it is made sure that only the net leak rate from the part under test is measured.

When switched to Stand-by / Vent again a new internal background is calculated after 25 s. The updated value is underlined. This means that if you press START when the value is underlined, the actual background signal will be subtracted. If you press START when the value is not underlined, the old background signal from the last Stand-by will be subtracted.

6.2.6 Decimal places

- [Main Menu](#) > [View](#) > [Decimal places](#)

The number of the decimal places of the displayed leak rate can be chosen. The default setting is 1.

Softkey 3: 1

The leak rate will be displayed with one decimal place.

Softkey 7: 2

The leak rate will be displayed with two decimal places.

Two decimals are especially useful, when the I•CAL leak rate filter (Please refer to Chapter [6.6.5.3](#)) is used.

6.2.7 Lower display limit

- [Main Menu](#) > [View](#) > [Lower display limit](#)

This parameter defines the lower leak rate limit in the measurement ranges. This is valid for vacuum modes only.

Softkey 3, 7: Changing of the lower detection limit between 1×10^{-5} and 1×10^{-12}

Softkey 5: ?

Help

6.3 Mode

- [Main Menu > Mode](#)

The mode menu [Fig. 6-4](#) enables the submenu to select the different working modes.

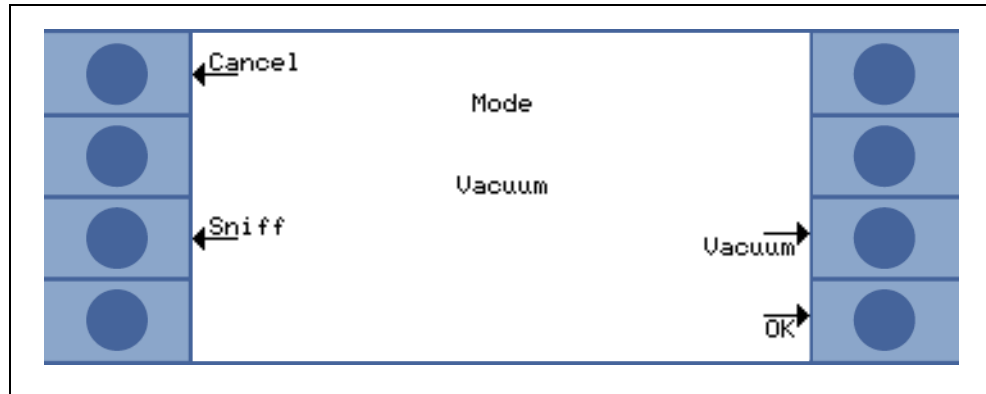

Fig. 6-4: The [Mode Menu](#)

| Key No. | Name | Description |
|---------|--------|--|
| 1 | Cancel | Return to the main menu without any changes of the present settings. |
| 7 | Vacuum | The normal vacuum mode will be used. Vacuum mode with the possibility to use HYDRO•S. HYDRO•S improves your time to test. Water vapor desorption in a test object generates an unwanted background signal. HYDRO•S separates and eliminates this signal from the helium signal, so testing can begin sooner. After changing to this mode, a new calibration necessary. Please refer to Chapter 6.6.1.4, HYDRO•S automatic ON. |
| 5 | | Not used in this menu. |
| 3 | Sniff | The sniff mode will be used. Please refer to Chapter 4.3.2 Sniffer Mode. |
| 8 | OK | Save the settings and return to the previous menu. |

6.4 Trigger & Alarms

- [Main Menu > Trigger & Alarms](#)

The trigger levels, the volume of the loudspeaker and the units of leak rates and pressures can be set in this menu [Fig. 6-5](#).

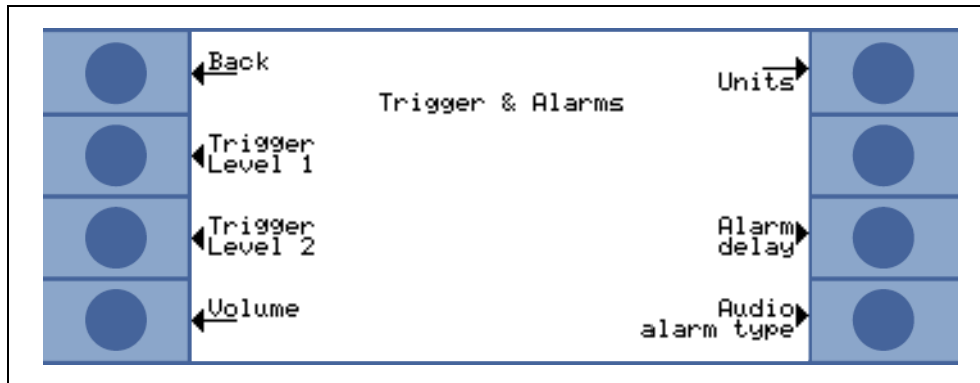

Fig. 6-5: The [Trigger & Alarms](#) Menu

| Key No. | Name | Description |
|---------|----------------------------------|--|
| 1 | Back | Return to the main menu. |
| 2 | Trigger Level 1 | Definition of Trigger level 1. Please refer to Chapter 6.4.1 |
| 3 | Trigger Level 2 | Definition of Trigger level 2. Please refer to Chapter 6.4.2 |
| 4 | Volume | Please refer to Chapter 6.4.3 |
| 5 | Units | Selection of leak rate and pressure units. Please refer to Chapter 6.4.4 |
| 6 | | Not used in this menu. |
| 7 | Alarm delay | Please refer to Chapter 6.4.5 |
| 8 | Audio alarm type | Choice of different alarm types. Please refer to Chapter 6.4.6 |

6.4.1 Trigger Level 1

- [Main Menu > Trigger & Alarms > Trigger Level 1](#)

The value of the first trigger level can be set. See [Chapter 4.2.2.7 Numerical Entries](#) for the description of the entry.

Trigger 1 and Trigger 2 are programmable leak rate levels. If these levels are exceeded some outputs of the UL5000 will react, especially if Trigger 1 is exceeded.

Display

In the status line of the display the signs for Trigger 1 and Trigger 2 are displayed inverted if the leak rate exceeds (becomes higher than) the programmed value.

Relay Output

The relays on the I/O interface [Fig. 2-6/2](#) will switch. See [Chapter 2.3.2.2 Digital Out](#) for further details.

Alarm/Loudspeaker

Trigger level 1 defines at which level the various alarm types react (See [Chapter 6.4.6 Audio alarm type](#))

6.4.2 Trigger Level 2

- [Main Menu](#) > [Trigger & Alarms](#) > [Trigger Level 2](#)

The value of the second trigger level can be set. See Chapter [4.2.2.7 Numerical Entries](#) for the description of the entry.

If Trigger 2 is exceeded the corresponding relay will switch. This is also indicated at the display.

6.4.3 Volume

- [Main Menu](#) > [Trigger & Alarms](#) > [Volume](#)

The minimum loudness and the regular volume of the loudspeaker can be adjusted. The minimum loudness is the minimum speaker volume that cannot be exceeded to even lower values. Thus it is avoided that the actual volume is accidentally reduced to a value that is below the noise level of the environment.

The actual volume can be adjusted between 15 (maximum) and the value defined as minimum loudness.

Softkey 2: Arrow down

Decrease the minimum loudness. The minimum value is 0.

Softkey 3: Arrow down

Decrease the actual volume. The minimum value is the value defined under minimum volume.

Softkey 4: Beep off / Beep on

Softkey 5: Help for volume

Help

Softkey 6: Arrow up

Increase the minimum volume. The maximum value is 15.

Softkey 7: Arrow up

Increase the regular volume. The maximum value is 15.

6.4.4 Units

- [Main Menu](#) > [Trigger & Alarms](#) > [Units](#)

The preferred leak rate unit can be selected. There is the choice of 4 (mbar, Pa, Torr, atm) pressure units and 5 leak rate units (mbar l/s, Pa m³/s-1, Torr l/s, atm cc/s).

Notice: In Sniff mode the following measuring units are selectable additionally (Refer to Chapter Chapter 6.3): ppm, g/a eq (helium leak rate is equivalent with leak rate R134a), oz/gr eq (helium leak rate is equivalent with leak rate R134a).

Softkey 2: Arrow up

Scroll up to select a pressure unit.

Softkey 3: Arrow down

Scroll down to select a pressure unit.

Softkey 6: Arrow up

Scroll up to select a leak rate unit.

Softkey 7: Arrow down

Scroll down to select a leak rate unit.

6.4.5 Alarm delay

- [Main Menu](#) > [Trigger & Alarms](#) > [Alarm delay](#)

In some applications (for instance during pump down in a „chamber test system“) it might be necessary to block an alarm for some time after pressing START.

This delay time of the alarm can be changed.

Softkey 3: Arrow down

Decrease the delay time. The minimum value is 0 seconds.

Softkey 7: Arrow up

Increase the delay time. The maximum value is 10 minutes up to infinity.

After pressing START the loudspeaker is activated as soon as the leak rate drops below trigger level 1 or after the entered alarm delay time has elapsed. This setting is only active for the audio alarm types SETPOINT and TRIGGER ALARM (See Chapter 6.4.6).

6.4.6 Audio alarm type

- [Main Menu](#) > [Trigger & Alarms](#) > [Audio alarm type](#)

The trigger of the audio alarm can be switched on or off.

Softkey 2: [Pinpoint](#)

See Chapter [6.4.6.1](#)

Softkey 3: [Leak rate prop.](#)

The sound will be proportional to the leak rate signal. See Chapter [6.4.6.2](#)

Softkey 6: [Setpoint](#)

See Chapter [6.4.6.3](#)

Softkey 7: [Trigger alarm](#)

An alarm sounds when the trigger 1 is exceeded. See Chapter [6.4.6.4](#)

6.4.6.1 Pinpoint

The tone of the acoustical signal changes its frequency only in a LR-window [Fig. 6-6](#) which ranges from one decade below the Trigger level 1 up to one decade above the Trigger level 1. Below the window the tone is constantly low, above the window it is constantly high.

Example: The Trigger level 1 is 4×10^{-7} mbar l/s. So the window where the tone changes reaches from 4×10^{-8} mbar l/s up to 4×10^{-6} mbar l/s.

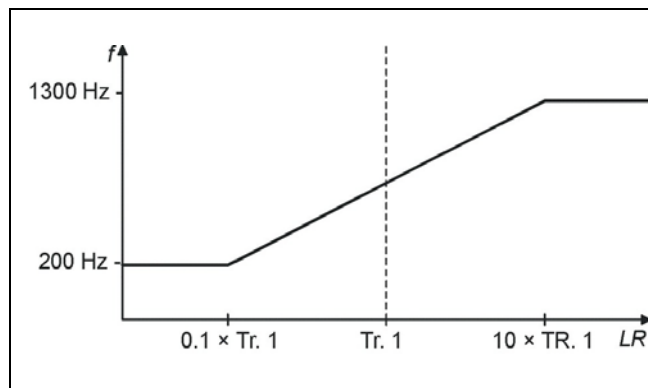

Fig. 6-6: Pinpoint

6.4.6.2 Leak rate prop.

The frequency of the acoustic output is proportional to the reading on the bargraph display. The frequency ranges from 200 Hz to 1300 Hz. See Chapter [6.2.1 Scale linear/logarithmic](#) for the definition of the number of decades.

6.4.6.3 Setpoint

The tone is off as long as the leak rate is below the Trigger level 1. Above Trigger 1 the tone varies proportional to the leak rate [Fig. 6-7](#).

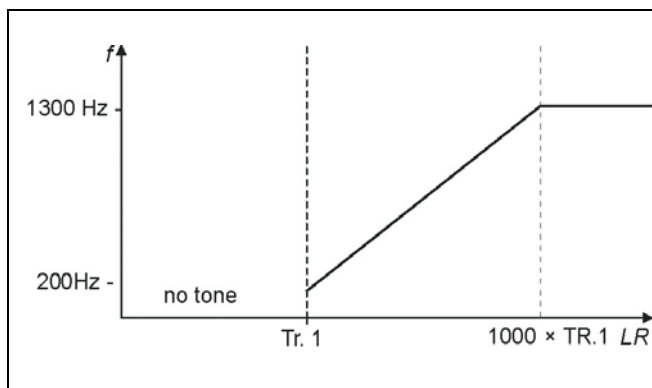

Fig. 6-7: Setpoint

6.4.6.4 Trigger alarm

As soon as the leak rate increases above trigger level 1, a multi-tone signal is generated. The tone does not vary with the leak rate.

6.5 Calibration

- [Main Menu](#) > [Calibration](#)

See [Chapter 7](#) for a detailed description of the calibration [Fig. 6-8](#).

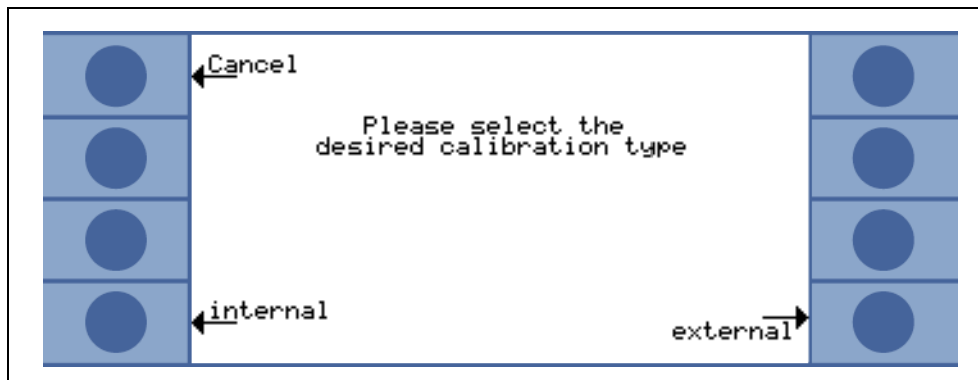

Fig. 6-8: The Calibration Menu

Softkey 4: internal

Softkey 8: external

6.6 Settings

- [Main Menu > Settings](#)

This menu [Fig. 6-9](#) allows to observe and to change the settings of the internal machine controls.

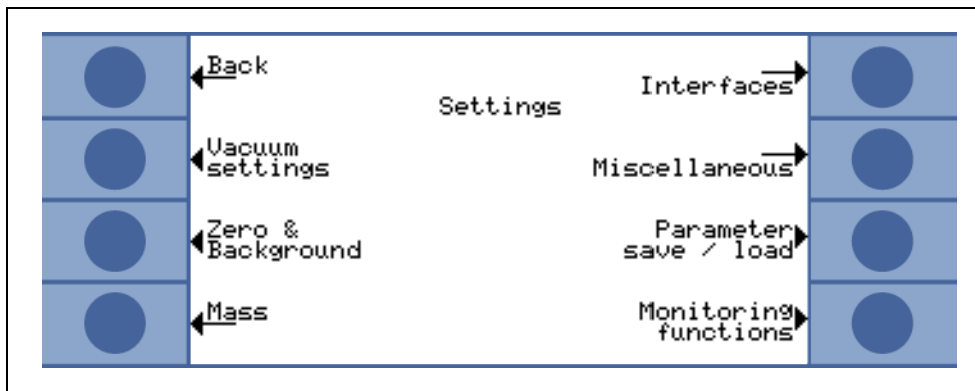

Fig. 6-9: The [Settings](#) Menu

| Key No. | Name | Description |
|---------|---------------------------------------|---|
| 1 | Back | Return to the main menu. |
| 2 | Vacuum settings | Settings of vacuum system related functions. See Chapter 6.6.1 |
| 3 | Zero & Background | See Chapter 6.6.2 |
| 4 | Mass | Switching between helium and hydrogen. See Chapter 6.6.3 |
| 5 | Interfaces | See Chapter 6.6.4 |
| 6 | Miscellaneous | See Chapter 6.6.5 |
| 7 | Parameter save / load | See Chapter 6.6.6 |
| 8 | Monitoring functions | Choose functions of protection of the UL5000 in with this mode. See Chapter 6.6.6 |

6.6.1 Vacuum settings

- [Main Menu](#) > [Settings](#) > [Vacuum settings](#)

This menu allows to observe and to change the settings belonging to the vacuum system.

Softkey 2: Automatic purge ([Purging](#))

Refer to Chapter [6.6.1.1](#)

Softkey 3: [Vent delay](#)

Please refer to Chapter [6.6.1.2](#)

Softkey 4: Booster TMP mode

Please refer to Chapter [6.6.1.7](#)

Softkey 5: Vacuum ranges

See Chapter [6.6.1.3](#)

Softkey 6: [Leak rate internal test leak](#)

Please refer to Chapter [6.6.1.5](#)

Softkey 7: [Machine factor](#)

Please refer to Chapter [6.6.1.6](#)

Softkey 8: Booster TMP mode

Please refer to Chapter [6.6.1.7](#)

6.6.1.1 Automatic purge

- [Main Menu](#) > [Settings](#) > [Vacuum settings](#) > [Automatic purge](#)

Through this menu it is possible to program the automatic purge (Please refer to Chapter [5.3.1](#)) for 20 seconds when switching from measuring to standby mode.

Softkey 3: OFF

Automatic purge is switched off at standby mode.

Softkey 7: ON

Automatic purge is activated. When switching from measurement to STANDBY the forepump is rinsed automatically for 20 seconds.

6.6.1.2 Vent delay

- [Main Menu](#) > [Settings](#) > [Vacuum settings](#) > [Vent delay](#)

Through this menu item it is possible to define the delay time until the inlet port is vented when operating the STOP button. When the STOP button is pressed for a period of time which is shorter than the delay time specified here, the UL5000 will just change to Stand-by mode.

When the STOP button is pressed for a period of time which is longer than the delay time specified here, the UL5000 will vent the inlet port.

Softkey 2: Immediately

The inlet port will be vented immediately after pressing the STOP button.

Softkey 3: After 1 second

The inlet port will be vented with a time delay of 1 second.

Softkey 4: After 1.5 seconds

The inlet port will be vented with a time delay of 1.5 seconds.

Softkey 6: after 2 seconds

The inlet port will be vented with a time delay of 2 seconds.

Softkey 7: No vent

The inlet port cannot be vented with the STOP button.

6.6.1.3 Vacuum ranges

- [Main Menu](#) > [Settings](#) > [Vacuum settings](#) > [Vacuum ranges](#)

With this menu you can adjust different modes concerning the activity of leak detection. This setting is only active in mode vacuum (see Chapter 6.3).

Softkey No. 2: ULTRA ONLY

In this mode the UL5000 remains in the area ULTRA after running under 0,4 mbar at the inlet flange (see Chapter 4.3.1). When showing the pressure at the inlet flange > 0,4 mbar the UL5000 switches immediately into evacuation mode.

Softkey No. 3: FINE only

In this mode the UL5000 remains after falling below 2 mbar at the inlet flange in FINE mode. Valve V1a will be closed. When the pressure at the inlet flange is increasing > 1 mbar the UL5000 switches immediately into evacuation mode. The lower detection limit of FINE ONLY is 1×10^{-10} mbar l/s. The advantage of FINE ONLY is that while this mode is running no valve will switch.

Softkey No. 5: ?

Help

Softkey No. 7: all areas (default settings)

This is the default setting. The activity runs as explained in Chapter 4.3.1.

6.6.1.4 HYDRO•S

Main Menu > Settings > Vacuum settings > HYDRO•S

Notice: This setting is only valid, if mass mode is set to „⁴He“. See Chapter 6.3.

Softkey 7: enable

If HYDRO•S automatic is enabled, the UL5000 switches HYDRO•S on and off at the following conditions:

HYDRO•S is switched on, if

- ZERO is off and
- $p_1 < 0,3 \text{ mbar}$ and
- Leak rate is between $2 \times 10^{-10} \text{ mbar l/s}$ and $3 \times 10^{-10} \text{ mbar l/s}$ and
- HYDRO•S was not switched on manually

The lower detecting limit for HYDRO•S is $1 \times 10^{-10} \text{ mbar l/s}$

You can always switch HYDRO•S on and off manually, even if automatic is enabled.

Notice: Switching HYDRO•S manually, deactivates the automatic until the next measuring cycle (STOP/START).

Softkey 3: disable

HYDRO•S is disabled. Leak rate higher than $3 \times 10^{-10} \text{ mbar l/s}$

If HYDRO•S is disabled, it can not be switched on/off manually anytime.

Softkey 5: Automatic OFF

HYDRO•S can be switched on/off manually by Softkey 4 in display mode (See Chapter 5.4.6)

6.6.1.5 Leak rate internal test leak

- Main Menu > Settings > Vacuum settings > Leak rate internal test leak

The value of the internal test leak can be set. See Chapter 4.2.2.7 Numerical Entries for the description of the entry.



Warning

Normally there is no reason to edit the leak rate of the internal test leak besides after a change of the internal test leak. A wrong leak rate of the internal test leak will lead to wrong leak rate readings!

6.6.1.6 Machine factor

- [Main Menu](#) > [Settings](#) > [Vacuum settings](#) > [Machine factor](#)

The machine factor takes into account that an additional external pump set is used. Based on an internal calibration only, all measured leak rate would be measured too small. The measured leak rate is multiplied with the machine factor and the result is displayed. This factor is only used for vacuum measurement modes (not for sniff mode). See Chapter [4.2.2.7 Numerical Entries](#) for the description of the entry.

Adjust the machine factor to the value 400 when using the helium sniffer QUICK TEST .

6.6.1.7 Booster TMP mode

- [Main Menu](#) > [Settings](#) > [Vacuum settings](#) > [Booster TMP mode](#)

Softkey 3: Off

Booster TMP will not start.

Softkey 7: automatic

Booster TMP starts automatically when evacuating.

6.6.2 Zero & Background

- [Main Menu](#) > [Settings](#) > [Zero & Background](#)

The kind of background suppression inside the UL5000 and the function of the Zero button can be selected.

Softkey 3: Background suppression

Refer to Chapter [6.6.2.1](#)

Softkey 4: Calculate inlet area background

Refer to Chapter [6.6.2.2](#)

Softkey 7: Zero

Refer to Chapter [6.6.2.3](#)

6.6.2.1 Background Suppression

- [Main Menu](#) > [Settings](#) > [Zero & Background](#) > [Background Suppression](#)

By this mode the internal helium background of the UL5000 will be subtracted at every measurement after pressing START. This function helps to save clean up of the UL5000 after a helium contamination.

Softkey 3: Off

Background suppression is switched off

Softkey 6 Inlet area

In addition to the internal background subtraction the background from the inlet port area will be subtracted at every measurement after pressing START. When the function "Inlet Area" is selected, the value of the inlet port area background can be determined before using the UL5000 for testing (See Chapter 6.6.2.2).

If the actual background is higher than 1×10^{-8} mbar l/s the inlet area suppression does not work. The high background must then be pumped down.

Softkey 7 Internal only

The internal background (see Chapter 6.2.5) will be calculated when switching to STAND-BY mode. This value will be subtracted when pressing START.

6.6.2.2 Calculate Inlet Area Background

- [Main Menu](#) > [Settings](#) > [Zero & Background](#) > [Calculate Inlet Area Background](#)

This function calculates the value of the internal helium background that will be subtracted from the measured signal when pressing START.

To start the calculation the UL5000 must be in the following state of condition:

- Mode Vacuum (refer to Chapter 6.3)
- Inlet port blanked off
- UL5000 is in STAND-BY mode for at least 1 minute
- UL5000 operates at least 20 minutes since powered on

The condition that is not yet fulfilled before doing the calculation will be back lighted on the display. If all conditions are fulfilled "OK" shows up at the display and the calculation can be started by pressing softkey no. 8. The procedure of the calculation takes about 2 minutes, the status is displayed during the process. The helium background is indicated as the measured ion current in the mass spectrometer.

If the above prerequisites are met, you can also calculate the inlet area background by choosing the button CAL function.

Notice: It is recommended to update the inlet area background calculation from time to time because the UL5000 is pumping down an existing inlet area background after a while.

6.6.2.3 Zero

- [Main Menu](#) > [Settings](#) > [Zero & Background](#) > [Zero](#)

This setting enables (respectively disables) the ZERO button at the control panel.

Softkey 2: Zero at ULTRA

With "Zero at ULTRA" the ZERO function executes automatically as soon as the measuring range ULTRA is reached for the first time after START. In this mode the ZERO function also can be executed manually via the ZERO button.

Softkey 3: Disable: ZERO function

Softkey 5: Help

Softkey 6: I•Zero

The Zero function is locked as long as the leak rate signal is not stable enough to detect a leak of the programmed value of Trigger 1.

The function „I•Zero“ enables the ZERO button only at stable leak rate signals. This is displayed in the status bar through the STABLE signal.

By the standard Zero function the actual background value will be subtracted when pressing ZERO. At falling background signals smaller leaks could be missed because the subtracted background value is higher than the leak rate signal at the moment of measuring.

By „I•Zero“ the drift of the falling background signal is checked, if it is higher than 0.5 x trigger value 1 (adjusted to the desired rejection level).

If I•ZERO function is active, the configured trigger value 1 is displayed.

Softkey 7: Enable: ZERO function

6.6.3 Mass

- [Main Menu](#) > [Settings](#) > [Mass](#)

The requested mass of the measured gas can be selected. The UL5000 must be in Stand-by.

Softkey 2: H₂ (2 amu)

Hydrogen with the mass of 2 amu will be measured.

Softkey 3: ³He (3 amu)

Isotope of helium with the mass of 3 amu will be measured.

Softkey 7: ⁴He (4 amu)

Helium with the mass of 4 amu will be measured.

Notice: HYDRO•S can only be used at this mass setting.

6.6.4 Interfaces

- [Main Menu](#) > [Settings](#) > [Interfaces](#)

The parameters of the interface can be set.

Softkey 3: [Control Location](#)

Please refer to Chapter [6.6.4.1](#)

Softkey 4: [RS232 Protocol](#)

Please refer to Chapter [6.6.4.3](#)

Softkey 7: [Recorder output](#)

Please refer to Chapter [6.6.4.2](#)

Softkey 8: [Scaling Recorder Output](#)

Please refer to Chapter [6.6.4.4](#)

6.6.4.1 Control Location

- [Main Menu](#) > [Settings](#) > [Interfaces](#) > [Control Location](#)

Softkey 2: PLC

The UL5000 is controlled via the Digital In connector (See Chapter [6.6.4.2](#)). The START, STOP and ZERO buttons at the control panel are locked.

Softkey 3: RS232

The UL5000 is controlled via RS232 interface by an external computer. In this mode the UL5000 can not be controlled via keyboard. The START, STOP and ZERO button at the machine are deactivated.

Softkey 5: Local & PLC

The UL5000 is controlled via the Digital In connector or the START, STOP and ZERO buttons at the control panel.

Softkey 6: Local & RS232

The UL5000 is controlled via the Digital In connector or the START, STOP and ZERO buttons at the control panel.

Softkey 7: Local

The UL5000 is controlled via the START, STOP and ZERO buttons at the control panel. The Digital In connector is not used.

6.6.4.2 Recorder output

- [Main Menu](#) > [Settings](#) > [Interfaces](#) > [Recorder output](#)

The signals to be recorded can be selected in this submenu.

Softkey 1: Cancel

Return to the previous menu without any changes of the present settings.

Softkey 2: Arrow up

Address recorder output 1 or 2

Softkey 3: Arrow down

Address recorder output 1 or 2

Softkey 5: Help

Softkey 6: Arrow up

Behaviour recorder output. For further information see keywords below.

Softkey 7: Arrow down

Behaviour recorder output. For further information see keywords below.

Softkey 8: OK

Saving off chosen parameters

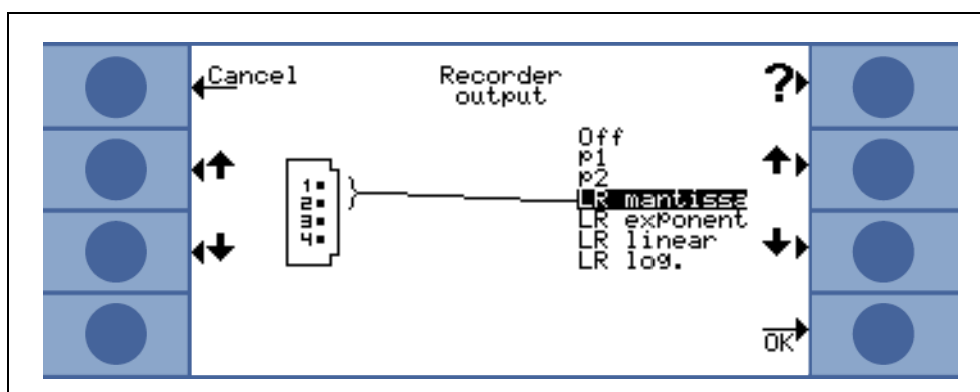

Fig. 6-10

Off

The recorder output is switched off.

p_1 / p_2

The fundamental output voltage is scaled logarithmic. The inlet pressure p_1 or the forevacuum pressure p_2 can be recorded.

The signals p_1 and p_2 have the characteristics of the Pirani gauge TPR265 (see chart in appendix).

LR lin

The leak rate output voltage is scaled linear. The fundamental voltage is 0-10 V in scalable steps from 0.5 to 10 volts per decade.

For information about scaling see chapter [6.6.4.4](#)

LR log

The leakrate is recorded on a logarithmic scale. The voltage output ranges from 1 ... 10 V with steps of 0.5 V per decade.

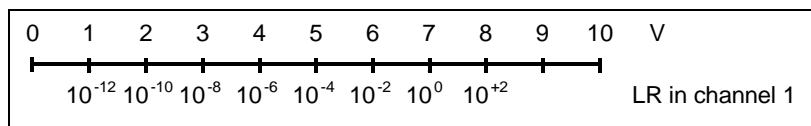

Fig. 6-11 Example of range of leak rate, log, 0.5 V/decade

For adjusting of scaling see chapter [6.6.4.4](#).

LR mantissa:

The leak rate mantissa is recorded linearly from 1 ... 10 V.

LR exponent

The exponent is recorded. Step function: U = 1 ... 10 V with steps of 0.5 V per decade, starting with 1 V = 1×10^{-12} .

6.6.4.3 RS232 Protocol

- [Main Menu](#) > [Settings](#) > [Interfaces](#) > [RS232 Protocol](#)

Softkey 3: Diagnostics

Gives the chance to read parameters, e.g. during maintenance.

Softkey 4: Printer Manual

Leak rates measured by this function can be sent to RS232 printers or PC. The measured value can be displayed via hyperterminal programs. The baudrate of this printer function is set to 9600, 8N1. Connected data loggers must be set to these parameters.

Format of the leak rate output:

LR = 1.00E-10 09:Apr.07 08:25 MEAS

LR: Leak rate

The measured value is equal to the number which then follows. In case of overflow or underflow the symbol < (leak rate is less than the stated value) or > (leak rate is greater than the stated value) is output accordingly.

1.00E-10: Output of the measured value in the unit set up, followed by date and time.

MEAS: The UL5000 is in the measure mode.

When pressing the START button once again in the measure mode or activation of the START input at the DIGITAL IN port the leak rate will be send out.

Softkey 5: ?

Help

Softkey 6: UL2xx Leak Ware

Gives the chance to control and read measurement values when connecting to a computer.

Notice: The calibration function of the Leak Ware is not appropriate to operate with the UL5000.

Please execute the function „STORE DATE“ in the operating mode „Single Part Measurement“ for starting the record of the measured values.

Softkey 7: ASCII

Gives the chance to use the UL5000 via a RS232 terminal.

6.6.4.4 Scaling Recorder Output

- [Main Menu](#) > [Settings](#) > [Interfaces](#) > [Scaling Recorder Output](#)

Here the scaling of the recorder output can be adjusted. This adjustment is only valid for the setting “LR lin” or “LR log” (refer to Chapter [6.6.4.2 Recorder output](#)).

Softkey 2: Arrow up

Adjust decade of the upper limit value

Softkey No. 3: Arrow down

Scaling of the previously adjusted value in steps of 0.5, 1, 2, 2.5, 5, 10 Volt/decade. The complete voltage range is 10 V. (Only for signal “LRlog”)

Softkey No. 6: Arrow up

Adjust decade of the upper limit value

Softkey No. 7: Arrow down

Scaling of the previously adjusted value in steps of 0.5, 1, 2, 2.5, 5, 10 Volt/decade. The complete voltage range is 10 V. (Only for signal “LRlog”)

Example:

Chart recorder output: “LRlog”

Upper limit value is adjusted to 10^{-5} (= 10V)

Scaled to 5 V /decade

Lower limit value consequently is 10^{-7} (= 0 V)

6.6.5 Miscellaneous

- [Main Menu](#) > [Settings](#) > [Miscellaneous](#)

The actual date and time, the preferred language and the mains frequency can be set in this submenu.

Softkey 2: [Time&Date](#)

See Chapter [6.6.5.1](#)

Softkey 3: [Language](#)

See Chapter [6.6.5.2](#)

Softkey 4: [Leak rate filter](#)

See Chapter [6.6.5.3](#)

Softkey 5: [Background Suppression](#)

See Chapter [6.6.2.1](#)

Softkey 6: [Mains Frequency](#)

See Chapter [6.6.5.4](#)

Softkey 7: Service interval exhaust filter.

See Chapter [6.6.5.5](#)

Softkey 8: Service message exhaust filter.

See Chapter [6.6.5.6](#)

6.6.5.1 Time&Date

- [Main Menu](#) > [Settings](#) > [Miscellaneous](#) > [Time&Date](#)

Date and time can be changed on two subsequent pages. See Chapter [4.2.2.7 Numerical Entries](#) for the description of the entry.

6.6.5.2 Language

- [Main Menu](#) > [Settings](#) > [Miscellaneous](#) > [Language](#)

The preferred language can be selected by pressing Softkey 3 and 7. The default setting is English.

Selectable languages: English, German, French, Italian, Spanish, Polish, Chinese (Mandarin), Japanese (Katakana), Korean.

Notice: The default setting can be reset by pressing the softkey 2 and 6 simultaneously during run-up of the leak detector.

6.6.5.3 Leak rate filter

- [Main Menu](#) > [Settings](#) > [Miscellaneous](#) > [Leak rate filter](#)

The kind of the leak rate filter can be chosen. The default value is I•CAL.

Softkey 3: Fixed

A filter with a fixed time constant will be used.

Softkey 7: I•CAL

I•CAL makes sure that the averaging time is optimal based on the leak rate level.

I•CAL stands for Intelligent Calculation Algorithm of leak rates. It makes sure that the signals are averaged in optimized time intervals, based on the leak rate intensity. I•CAL also eliminates noise peaks which are not related to leak rate signals and provides unexpected short response times for low leak rate signals.

The algorithm used provide excellent sensitivity and response time and is there for the recommended setting.

6.6.5.4 Mains Frequency

- [Main Menu](#) > [Settings](#) > [Miscellaneous](#) > [Mains Frequency](#)

The mains frequency takes the different pumping speed of the scroll pump into account. The frequency of the mains power supply can be selected. The default setting is 50 Hz for 230 V and 60 Hz for 115 V.

Softkey 3: 50 Hz

The UL5000 will be run at a mains frequency of 50 Hz.

Softkey 6: 60 Hz

The UL5000 will be run at a mains frequency of 60 Hz.

6.6.5.5 Service interval exhaust filter

Here you can enter the service interval of the exhaust filter.

Softkey 3: Down

Decrease of the service interval steps of within 500 hours.

Softkey 5: ?

Help

Softkey 7: Up

Increase of the service interval within steps of 500 hours. The limit is 4000 hours.

6.6.5.6 Service message exhaust filter

The exhaust filter must be maintained at regular intervals to ensure the correct function of the UL5000. If the service message is activated, the UL5000 reminds you of the required maintenance.

Softkey 3: Off

Softkey 5: Help

Softkey 7: On



Warning

If the service messages are ignored and the exhaust is not replaced a risk for overheating the pump motor exists.

6.6.6 Parameter save / load

- [Main Menu](#) > [Settings](#) > [Parameter save / load](#)

Enables to save and load individual settings or reload the default settings.

Softkey 2: Save as „PARA SET 1“

See Chapter [6.6.6.1](#)

Softkey 3: Save as „PARA SET 2“

See Chapter [6.6.6.1](#)

Softkey 4: Save as „PARA SET 3“

See Chapter [6.6.6.1](#)

Softkey 5: Load default

Reload the default settings.

Softkey 6: Load „PARA SET 1“

See Chapter [6.6.6.2](#)

Softkey 7: Load „PARA SET 2“

See Chapter [6.6.6.2](#)

Softkey 8: Load „PARA SET 3“

See Chapter [6.6.6.2](#)

6.6.6.1 Save parameter set

- [Main Menu](#) > [Settings](#) > [Parameter save / load](#) > [Save](#)

Save the current parameter settings.

Softkey 4: Edit a file name

Rename the parameter set.

6.6.6.2 Load parameter set

- [Main Menu](#) > [Settings](#) > [Parameter save / load](#) > [Save parameter set](#)

The settings of the selected saved parameter set will be displayed and can be reloaded.

Softkey 6: Arrow up

Upward to the previous screen.

Softkey 7: Arrow down

Downward to the next screen.

6.6.7 Monitoring functions

- [Main Menu](#) > [Settings](#) > [Monitoring functions](#)

Calibration request

- [Main Menu](#) > [Settings](#) > [Monitoring functions](#) > Calibration request

It can be selected whether the operator is reminded of the fact that a calibration may have become necessary or not. The default value is off.

Softkey 3: Off

The calibration request will be switched off.

Softkey 7: ON

The calibration request will be switched on.

If the calibration request is switched on, a corresponding message will appear when 30 minutes have elapsed after power on or if the temperature of the UL5000 has changed by more than 5 °C (9 °F) since the last calibration.

Particle protection

- [Main Menu](#) > [Settings](#) > [Monitoring functions](#) > Particle protection

This mode can be switched on and off.

If switched on the UL5000 will not start pumping down before the inlet has not dropped below 1 mbar. I. e. it is assumed that the part under test is pumped by another pump in parallel.

Purpose: When the leak detector does not pump at high pressures no gas stream, possibly carrying particles gets into the leak detector.

Contamination protection

- [Main Menu](#) > [Settings](#) > [Monitoring functions](#) > Contamination protection

If this mode is switched on the UL5000 closes all inlet valves as soon as the measured leak rate exceeds the programmed leak rate. Thus no more Helium gets into the mass spectrometer. Helium that has gotten into the tool under test can be pumped away by the tool pump. If no extra pump is available it is recommended to vent the part before the test is continued.

Pressure limits for vacuum ranges

- [Main Menu](#) > [Settings](#) > [Monitoring functions](#) > Pressure limits for vacuum ranges

With this function you can adjust the switching point between the modes GROSS-FINE-ULTRA. This can be essential when other gases than air are pumped with the UL5000. The control signal of the Pirani may vary at other gases than air. Therefore it may be necessary to adjust the switching points.

Softkey No. 2, 6: Change over threshold EVAC-GROSS
.15-3 mbar (Default value 15 mbar)

Softkey No. 3, 7: Change over threshold GROSS-FINE
2-0,5 mbar (Default value 2 mbar).

When changing this values the change over FINE-ULTRA threshold will automatically be retightend to 0,4 - 0,1 mbar.

Softkey No. 4 Adjustment for ARGON
Press again the softkey for default values for air.

Softkey No. 5: ?
Help

Pressure limits for sniff mode

- [Main Menu](#) > [Settings](#) > [Monitoring functions](#) > Pressure limits for sniff mode

This function is automatically activated in sniff mode. The pressure limits define an upper and lower limit of the inlet pressure. The upper limit is 2 mbar, the lower limit is 0.02 mbar. If the pressure is not in this range error messages are generated:

P > upper limit: Capillary broken

P < lower limit: Flow through capillary too low (Capillary blocked)

Maximum evacuation time

- [Main Menu](#) > [Settings](#) > [Monitoring functions](#) > Maximum evacuation time

This menu item is used to define when the gross leak message is to occur. The gross leak detection process operates in two steps and the limits can be adapted as required.

This menu item is particularly useful in series testing under the same conditions at all times.

After pressing the start button the test sample is evacuated. If the pressure conditions ($p_1 < 100$ mbar) are not attained, or if the pressure does not drop low enough within the periods of time specified here, the pumpdown process is terminated and the display will indicate a message (see 8.2, W76).

The periods which are selected in each case depend firstly on the desired reaction time for the gross leak message, and secondly on the volume of the test sample and the effective pumping speed.

Caution: If the evacuation time was set to endless, the oil level of the mechanical pump should be checked more often.

Softkey No. 2: ↓

Decreasing maximum evacuation time until $p_1 < 100$ mbar. Within this period of time the inlet pressure at the test flange must have dropped below 100 mbar. The duration may be selected freely between 1 second and 9 minutes or can be set to endless. The default is 30 seconds.

Softkey No. 3: ↓

Decreasing maximum time until measurement Within the period of this time the status of measurement readiness must have been attained, i.e. the inlet pressure must have dropped below 15 mbar. The duration may be freely selected between 5 seconds and 30 minutes or can be set to endless.

Softkey No. 5: ?

Help text

Softkey No. 6: ↑

Increasing maximum evacuation time until $p_1 < 100$ mbar

Softkey No. 7 ↑

Increasing maximum time until measurement.

6.7 Information

- [Main Menu > Information](#)

The [Information](#) Menu [Fig. 6-12](#) enables submenus to select different kinds of information belonging to the UL5000.

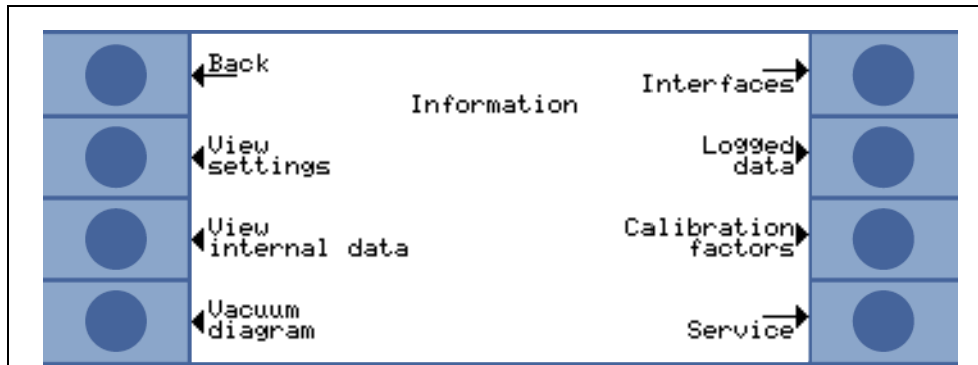

Fig. 6-12: The [Information](#) Menu

Softkey 2: View settings

The current settings will be displayed on 4 pages, e.g. trigger levels, test leak mass, date and time.

Softkey 3: View internal data

Information on measured internal data is provided on 4 screens.

Softkey 4: Vacuum diagram

The vacuum diagram of the UL5000 will be displayed. Opened and closed valves are also shown.

Softkey 5: View error list

The list of occurred errors and warnings will be displayed.

Softkey 6: Calibration history

The carried out calibrations will be listed.

Softkey 7: Calibration factors

The vacuum diagram of the UL5000 is shown. Here you can see which valves are open or closed momentarily and more.

Softkey 8: [Service](#) (See [Chapter 6.7.1](#))

6.7.1 Service

- [Main Menu > Information > Service](#)

This screen allows to get into the service menu. Enter the password first. The initial service password is *not* provided with the shipment, only after a specific service training. Please refer to [Chapter 4.2.2.7](#) for the description of the entry.

The service menu appears after the successful input of the password. Special functions (e. g. switching the valves manually) are possible in this menu only. For further information please refer to [Service Menu \(iipa74e1-b\)](#).

6.8 Access Control

- [Main Menu > Access Control](#)

In this sub-menu some functions can be assigned to specific users.

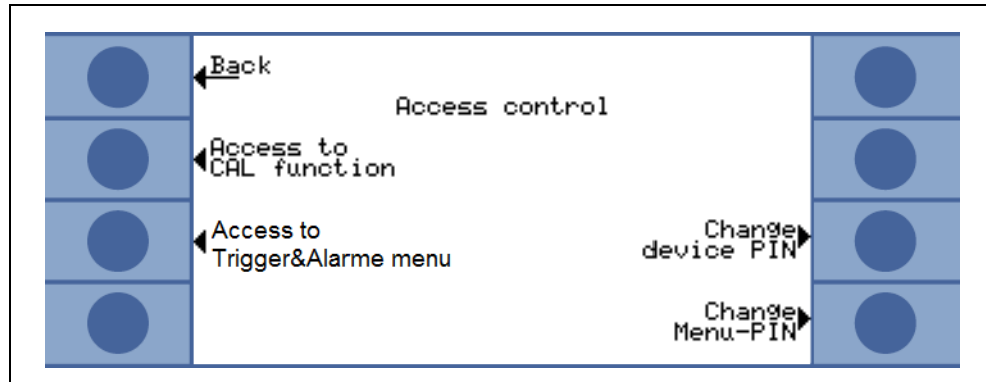

Fig. 6-13: The [Access Control](#) Menu

Softkey 2: [Access to CAL function](#)

Please refer to [Chapter 6.8.1](#)

Softkey 3: [Access to Trigger&Alarme menu](#)

Please refer to [Chapter 6.8.2](#)

Softkey 7: [Change Device PIN](#)

Please refer to [Chapter 6.8.3](#)

Softkey 8: [Change Menu-PIN](#)

Please refer to [Chapter 6.8.4](#)

6.8.1 Access to CAL function

- [Main Menu > Access Control > Access to CAL function](#)

It can be selected whether the access to the calibration menu is restricted or not.

Softkey 3: Off

The calibration function is only available at the main menu. If the Menu-PIN (See [Chapter 6.8.4](#)) is activated you need this PIN to start a calibration.

Softkey 7: ON

The calibration function is available at the main menu and in Stand-by and the measure mode.

Softkey 8: OK

Save the settings and return to the previous menu.

6.8.2 Access to Trigger&Alarme menu

- [Main Menu](#) > [Access Control](#) > [Access to Trigger&Alarme menu](#)

That allows access to this function (see Chapter 6.4) even at a blocked menu access (see Chapter 6.8.4).

6.8.3 Change Device PIN

- [Main Menu](#) > [Access Control](#) > [Change Device PIN](#)

The access to the UL5000 can be restricted by a Device-PIN. If the Device-PIN is not 0000 the UL5000 will ask for this PIN directly after power on. Without device-PIN the UL5000 does not even switch on the pumps.

Notice: Under all circumstances memorize the PINs! The PIN can only be reset by INFICON's service organization.

6.8.4 Change Menu-PIN

- [Main Menu](#) > [Access Control](#) > [Change Menu-PIN](#)

The access to the menu can be restricted by entering or changing the personal identification number (PIN). No PIN will be checked if 0000 is entered.

See Chapter 4.2.2.7 for the description of the entry.

Notice: Under all circumstances memorize the PINs! The PIN can only be reset by INFICON's service organization.

7 Calibration

7.1 Introduction

The UL5000 can be calibrated in two different ways:

- Internal calibration by means of a built-in leak standard.
- External calibration by means of an additional leak standard which then is attached to the inlet port or the component under test.

During the calibration procedure the mass spectrometer is tuned to the maximum helium signal and this signal is referred to the known leak rate of the internal or external leak standard. Although the UL5000 is a very stable instrument a calibration is recommended from time to time to make sure that ambient temperature changes or dirt or other impacts don't adulterate the measurements.

When the unit is used constantly the calibration should be performed at least once a day. Otherwise the frequency of calibration depends on the frequency of use.

Notice: To get an optimized calibration the machine has to warm up at least 20 minutes before use.

Test leaks for calibration should not have a range lower than 1×10^{-9} mbar l/s to ensure a stable calibration signal.

7.2 The calibration routines

There are 3 ways to get into the calibration routine:

- In Stand-by mode (i.e. at the end of the run-up routine or after pressing the **STOP Button**) the calibration function can be initiated with **CAL** (Soft Key no. 5).
- Also in measurement mode the calibration routine can be started by pressing **CAL** (Soft Key no. 5).
- In the main menu the calibration again can be started with **CAL** (Soft Key no. 5).

A calibration may be terminated at any time by pressing the **STOP Button** or using the Soft Key no. 1 (*Cancel*).

Once the calibration mode is activated the user must choose between an internal and an external calibration. Please press the corresponding Soft Key.

7.2.1 Internal Calibration

For internal calibrations the UL5000 differentiates between two possibilities:

- If the unit is blanked off or disconnected from any chamber by a valve on the [Inlet Port](#) the automatic calibration can be chosen (Soft Key no. 8).
- If the unit is connected to a chamber or a bigger component the calibration has to be performed manually because the reaction times on opening or closing the internal leak standard vary depending on the volume of the chamber.

Notice: It is recommended to use the automatic calibration if possible.

7.2.1.1 Automatic Internal Calibration

Once this procedure is started the entire procedure is performed automatically. At the end (after about 25 s) a beep is released. Thereafter the unit is ready for further use.

7.2.1.2 Manual Internal Calibration

When [Manual Internal Calibration](#) is selected it is assumed that the UL5000 is connected to a component under test (if not please go to [Automatic Internal Calibration](#)).

After starting the [Manual Internal Calibration](#) the UL5000 pumps down the test part (if not already under vacuum) and opens the internal leak standard. Depending on the volume of the part it may take some time for the helium signal to stabilize. Therefore the user has to confirm that the signal has reached a stable level (Soft Key no. 8).

The unit now runs through the tuning process and closes the internal leak standard automatically. Again the volume of the test part determines how long it takes to pump down the helium and to reach a stable background level, which has to be confirmed by the user.

Thereafter the unit is calibrated.

7.2.2 External Calibration

For an external calibration a leak standard has to be attached to the part under test or the inlet port directly.

Notice: The shown leak rate can diverge of the printed values of the external calibrated leak because of uncertainties and temperature coefficients.

After **External Calibration** (Soft Key no. 8) has been chosen the following messages are displayed and the described actions are required:

- Make sure that the test leak is connected and opened.
- Check the leak rate printed on the test leak and compare it with the leak rate at the display. If the leak rates are not identical press *Edit leak rate* (Soft Key no. 4) and correct the value.
- If the leak rates are okay press *START* (Soft Key no. 8).

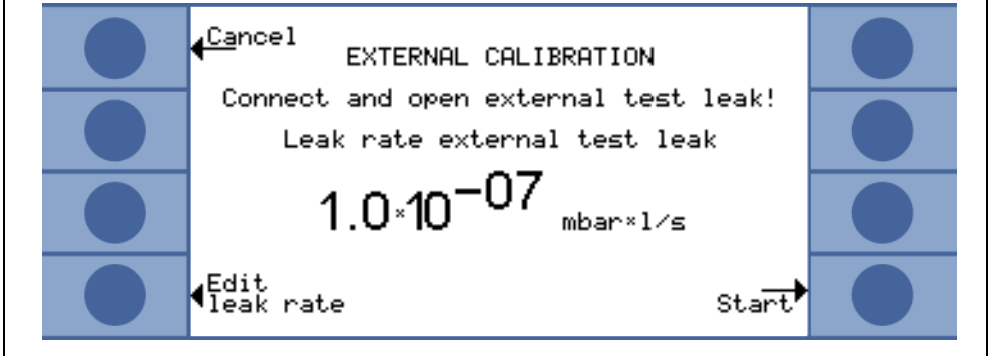

Fig. 7-1: External Calibration, Step 1

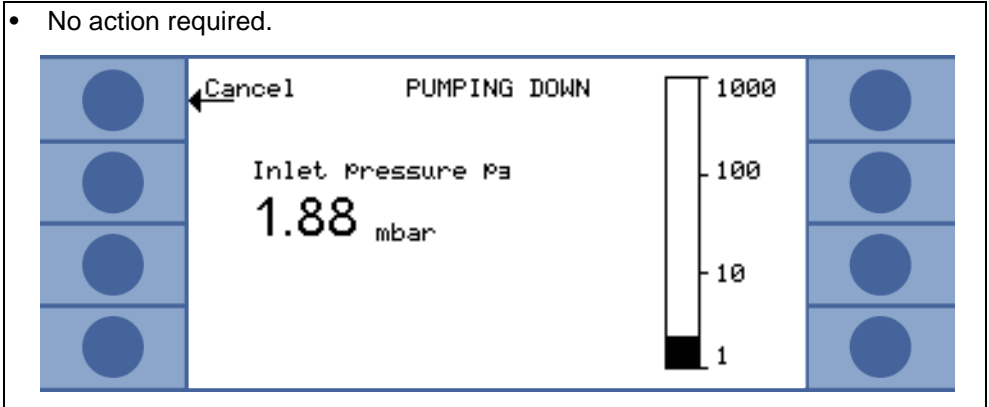

Fig. 7-2: External Calibration, Step 2

- The bargraph display shows a signal which must not vary much. If so please press *OK* (Soft Key no. 8).

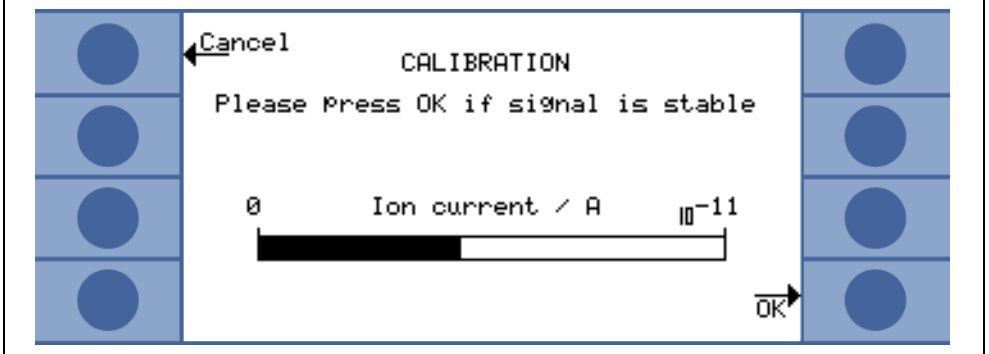

Fig. 7-3: External Calibration, Step 3

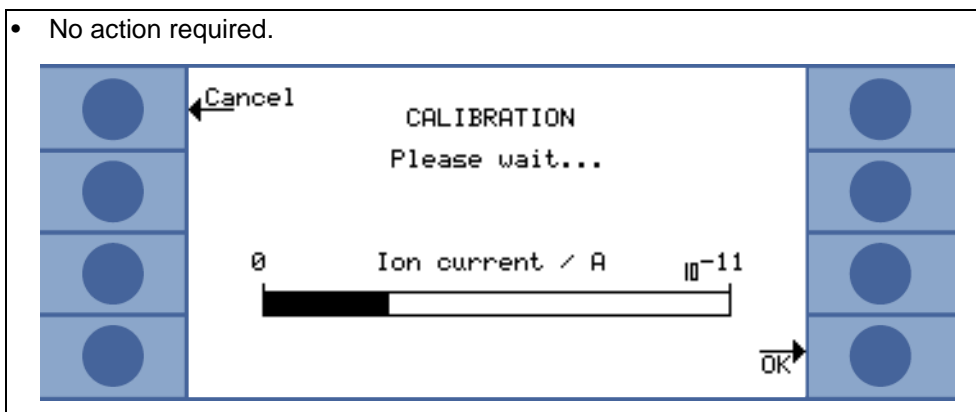

Fig. 7-4: External Calibration, Step 4

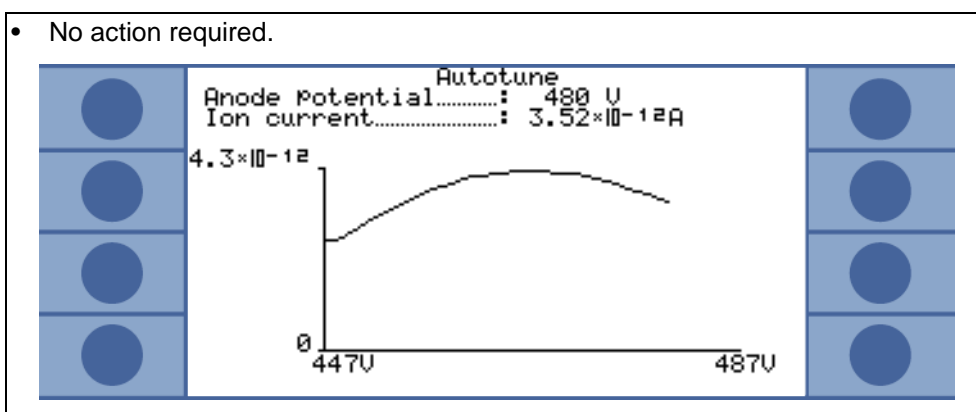

Fig. 7-5: External Calibration, Step 5

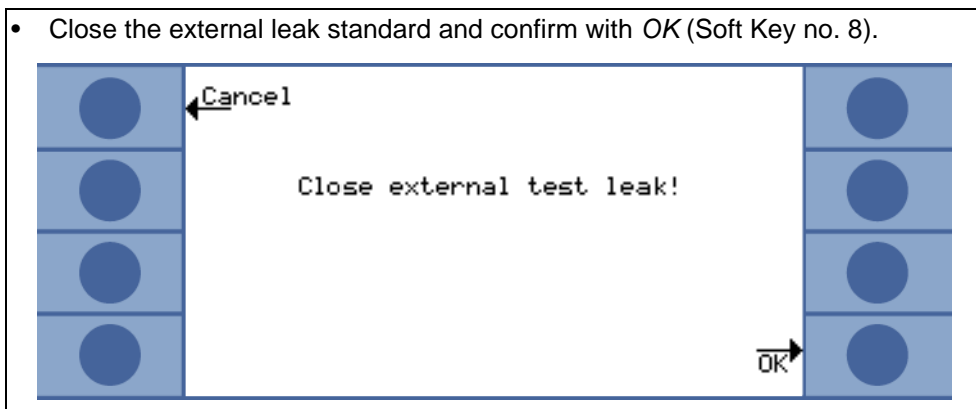

Fig. 7-6: External Calibration, Step 6

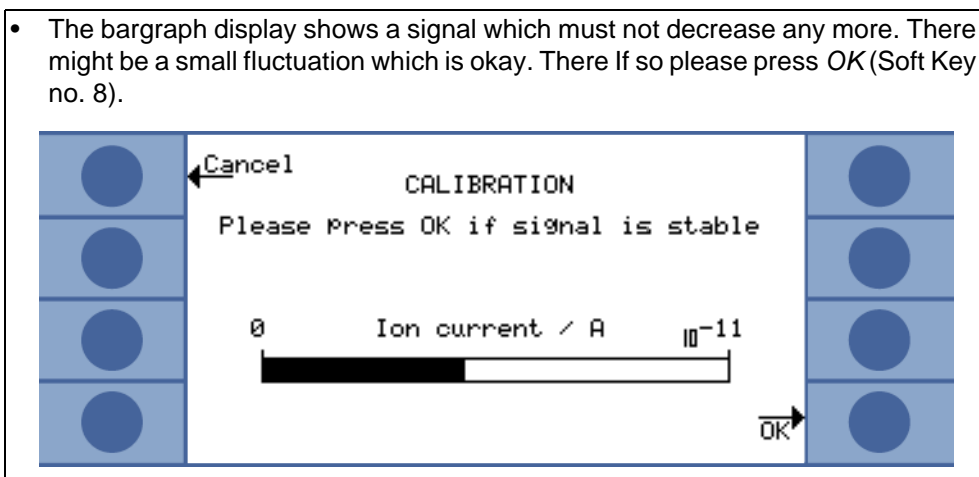

Fig. 7-7: External Calibration, Step 7

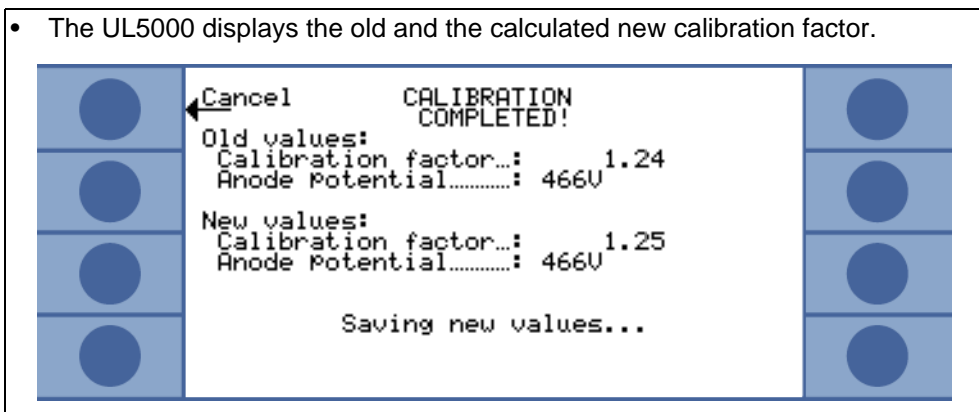

Fig. 7-8: External Calibration, Step 8

7.3 Factor of Calibration - Range of Values

To avoid a faulty calibration the factor of calibration is tested for plausibility at the end of the calibration routine:

When the new factor of calibration is not considerably higher or lower (< factor 2) than the previous factor of calibration the new factor will be accepted automatically. When the new factor of calibration diverges stronger from the previous factor the user can decide if he wants to accept it anyway (e. g. after changing the system configuration) or not (e. g. because of a maloperation).

Notice: When calibration is started via SPS or RS232 no testing for plausibility is performed.

When calibrating internal it is also monitored if the newly calculated factor of calibration is higher than 10 or lower than 0.1. In this case a warning (see W81 resp. W82 in Chapter 8.2) is displayed and the calibration will be interrupted.

8 Error And Warning Messages

The UL5000 is equipped with a comprehensive self-diagnostic facilities. If an error or warning condition is detected it is indicated via the LC display to the operator.

An audio signal is generated when an error or warning occurs. The frequency changes every 400 ms from 500 Hz to 1200 Hz and vice versa so that the signal stands out well from ambient noises normally encountered.

Error and warning messages are logged and can also be displayed at a later time through the menu information (See Chapter 6.7)

8.1 Hints

Warning Messages

Warnings will be indicated

- when the UL5000 detects an abnormal condition or
- when it wants to remind the operator of something (e.g. a request for calibration or a service timer has expired).

The UL5000 will indicate a message on the LC display and will remain in the Stand-by or the measurement mode.

Warning messages will remain on the LC display until the warning has been acknowledged by pressing „OK“ (Key no. 8). After that the UL5000 can be used again (possibly with some restrictions). As long as a warning status exists the status line shows a warning triangle (See Chapter 5.4.3).

The warning messages can be displayed in STANDBY by pressing the button  (shows up when warning message occurred).

Error Messages

Errors are events which force the UL5000 to interrupt its measurement operations. In this case the UL5000 closes all valves (Stand-by mode).

Error messages remain on the LC display until the message has been acknowledged by pressing „Restart“ (key no. 8). After that, the UL5000 restarts with a new run-up procedure. In some cases it may be helpful to check some settings or measured values before the UL5000 restarts. Therefore it is also possible to press „Menu“ (key no. 4 or Menu key) to enter the UL5000 menu. After leaving the menu the same error message will be displayed again.

Notice: Under extreme conditions (unknown software errors, excessively high electromagnetic interference levels) the built-in „watchdog“ circuit will prevent uncontrolled operation of the UL5000. This watchdog will cause the UL5000 to restart. After having done so, the instrument will be running in the Stand-by mode. No error message will be output.

8.2 List of Errors & Warnings

The following pages contain a list of all errors and warnings displayed at the control panel. Warning messages are indicated by numbers with a leading W. Error messages are indicated by numbers with a leading E.

| No. | Displayed Message | Description and possible solutions |
|-----|--|---|
| E03 | Suppressor test incorrect! | <ul style="list-style-type: none"> MSV board defective The pre-amplifier is defective The suppressor cable is faulty |
| W15 | Leak rate is too high! Machine switched into stand-by to prevent contamination | <p>The survey function „contamination“ is activated. A leak rate higher than the adjusted value was detected.</p> <ul style="list-style-type: none"> Gross leak Switch off limit is set too low Alarm delay time too short |
| W16 | Turbo molecular pump service interval expired! | The service interval for the turbo molecular pump is expired. |
| W17 | Forepump service interval expired! | The service interval for the fore pump is expired. |
| W18 | Exhaust filter service interval expired! | The service interval for the exhaust filter is expired. |
| W21 | EEPROM write timeout! | EEPROM defective MC 68 defective |
| W22 | EEPROM parameter queue overflow! | EEPROM defective MC 68 defective |
| E23 | 24V of the OPTION socket is too high | The tension 24V at socket OPTION is too high. |
| E24 | 24V at socket OPTION is too low | <ul style="list-style-type: none"> Fuse F2 on the I/O board has blown |
| E25 | Receded valve voltage too low (< 7V) | <ul style="list-style-type: none"> I/O board is faulty. |
| W28 | Real time clock reset! Please enter date and time! | <ul style="list-style-type: none"> Battery at MC68 is discharged or faulty. MC68 had been replaced. |
| E29 | 24V supply for fans is too low (< 20V) | <ul style="list-style-type: none"> Fuse F1 on wiring backplane has blown. |
| E30 | 24 V of the remote control is too low (> 20V). | <ul style="list-style-type: none"> Fuse F1 on the I/O-board has blown. |
| W31 | The offset voltage of the preamplifier is too high (> 5mV) | <ul style="list-style-type: none"> The preamplifier is faulty. |
| W32 | Preamplifier temperature is too high (> 60°C) | <ul style="list-style-type: none"> Ambient temperature is too high. Air filter dirty. |
| W33 | Preamplifier temperature is too low (< 2°C) | <ul style="list-style-type: none"> Ambient temperature is too low. Temperature sensor is faulty. |

| No. | Displayed Message | Description and possible solutions |
|-----|--|--|
| E34 | 24V voltage at MSV board is too low! | Signal MVPZN on the MSV board is active. 24 V signal voltage is too low, $U < 18.3 \text{ V}$. <ul style="list-style-type: none"> Fuse F1 on the MSV board has blown. 24 V power supply voltage is missing. <i>Switch off the UL5000!</i> The missing voltage will cause the exhaust valve on the scroll pump to close which in turn can lead to a contamination of the vacuum system. Reference voltage UREF on the MSV board XT7/1 is too high, $U > 5 \text{ V}$. |
| E35 | Anode-cathode voltage is too high! | <ul style="list-style-type: none"> MSV board is faulty. Anode-cathode voltage is higher than 130 V. |
| E36 | Anode-cathode voltage is too low. | <ul style="list-style-type: none"> MSV board is faulty. Anode-cathode voltage is lower than 30 V. |
| E37 | Suppressor voltage reference value too high! | Signal MFSZH on MSV board is active. Suppressor signal command variable is too high. <ul style="list-style-type: none"> Suppressor voltage has a short circuit. MSV is faulty. |
| E38 | Suppressor potential too high! | Suppressor potential is higher than 363V. <ul style="list-style-type: none"> MSV board is faulty. |
| E39 | Suppressor potential is too low | Suppressor potential is lower than 297V. <ul style="list-style-type: none"> MSV board is faulty. |
| E40 | The anode potential exceeds its nominal value by over 10%! | The actual anode potential exceeds its nominal value by 10%. The nominal value can be displayed in the service menu. <ul style="list-style-type: none"> MSV is faulty. |
| E41 | The anode potential has dropped below its nominal value by over 10%! | The actual anode potential has dropped below its nominal value by 10%. The nominal value can be displayed in the service menu. <ul style="list-style-type: none"> Air inrush. MSV is faulty. |
| E42 | Nominal value of the anode potential is too high! | Signal MFAZH on MSV board is active. <ul style="list-style-type: none"> Anode voltage has been short circuited. Nominal value of the anode voltage is too high. Anode voltage is limited to about 1,200 V. |
| E43 | Cathode current is too high! | <ul style="list-style-type: none"> Signal MPKZH on MSV board is active. Cathode current is too high, $I > 3.6 \text{ A}$. MSV is faulty. |
| E44 | Cathode current is too low! | <ul style="list-style-type: none"> Signal MPKZN on MSV board is active. Cathode current is too low, $I > 0.2 \text{ A}$. MSV is faulty. |
| W45 | Emission for cathode 1 can not be switched on! | Signal MSIBE on MSV board is not active. Emission for cathode 1 can not be switched on. UL5000 switches to cathode 2. Please order a new ion source. |
| W46 | Emission for cathode 2 can not be switched | Signal MSIBE on MSV board is not active. Emission for cathode 2 can not be switched on. UL5000 switches to cathode 1. Order a new ion source. |

| No. | Displayed Message | Description and possible solutions |
|-----|--|---|
| E47 | Emission for both cathodes can not be switched on! | Signal MSIBE on MSV board is not active. Emission can not be switched on. Exchange the cathode by changing the ion source. After having exchanged the ion source it must be possible to switch on both cathodes manually via the service menu. |
| E48 | Anode heater is faulty! | Signal MSAFD on MSV board is active. Anode heater fuse has blown. Replace fuse F2 on the MSV board. |
| E50 | No communication with turbo pump | Clock from the frequency converter has failed. No communication to the frequency converter. |
| E52 | TMP frequency is too low! | <ul style="list-style-type: none"> • TMP frequency is too low! • Frequency converter is faulty. • Turbomolecular pump is faulty. |
| W53 | Temperature at electronic unit is too high (>55°C) | <ul style="list-style-type: none"> • Ambient temperature too high. • Ventilation failure. • Air filter dirty and have to be changed. |
| E54 | Temperature at electronic unit is too high (>60°C) | <ul style="list-style-type: none"> • Ambient temperature is too high. • Internal ventilation has failed. • Air filters are dirty and must be exchanged. |
| W55 | Temperature at electronic unit is too low (< 2°C) | <ul style="list-style-type: none"> • The temperature sensor on the wiring plane indicates $T < 2$ °C. Run-up time for the forevacuum pump will be longer. • Temperature sensor is faulty. |
| E56 | Inlet pressure p1 too low! | <p>$U < 0,27$ V; Pressure sensor faulty.</p> <p>Change thermovac-sensor that measures p1.</p> |
| E58 | Foreline pressure p2 too low! | <p>$U < 0,27$ V; Pressure sensor faulty.</p> <p>Change thermovac-sensor that measures p2.</p> |
| E60 | p2>10mbar after 5 minutes since power on | <p>PV > 3.8 mbar after $t > 5$ minutes since switching on. Run-up time of the forevacuum pump is too long.</p> <ul style="list-style-type: none"> • Forepump is faulty. • Valve V2 does not open. |
| E61 | Emission fail | Emission should be switched on. MSV subassembly indicates a fault. MENB emission current not within range. |
| W62 | Flow through capillary too low | <p>In the sniffer mode the intake pressure of the sniffer line is controlled. If the pressure falls below the minimum limit, the flow through the capillary is too low (contamination) or the capillary is blocked (foreign objects, particles).</p> <p>The minimum limit can be set by the menu. Default value is 0.1 mbar. See Chapter 6.6.1.5.</p> |
| W63 | Capillary broken | <p>In the sniffer mode the intake pressure of the sniffer line is controlled. If the pressure exceeds the maximum limit, the flow through the capillary is too high (no leak tightness, broken capillary).</p> <p>The maximum limit can be set by the menu. Default value is 1.0 mbar. See Chapter 6.6.1.5.</p> |
| W65 | Booster-TMP failure! | <p>"Frequency converter is faulty",</p> <p>"Booster-TMP is faulty",</p> |

| No. | Displayed Message | Description and possible solutions |
|-----|---|---|
| W66 | Gate interrupt of the booster-TMP converter is missing! | "Frequency converter is faulty", "Booster-TMP is faulty", |
| W67 | Booster-TMP runup time exceeded! | "Frequency converter is faulty", "Booster-TMP is faulty", |
| W69 | Booster-TMP frequency is too high! | "Frequency converter is faulty", "Booster-TMP is faulty", |
| E73 | Emission off (p2 too high) | PV >> 0.2 or 3 mbar due to an inrush, e. g. The UL5000 will again try to resume the measurement mode. |
| W76 | Maximum of evacuation time was exceeded. | <ul style="list-style-type: none"> • Test sample has got a GROSS leak. • False adjustments of the max. time of evacuation. |
| W77 | Peak not in Range | The signal maximum has shifted to mass range alignment limits. <ul style="list-style-type: none"> • Signal of leak rate was instable during mass adjustment. Calibrate again. • Check the basic setting for the anode voltage through the service menu. • Check calibrated leak. |
| W78 | Differences of signal between test leak open and closed is too low. | The amplifier voltage difference between opened and closed calibrated leak is less than 10 mV. Calibrated leak has not been closed properly. |
| W79 | Signal of test leak is too small | Calibrated leak is too small or has not been opened. Pre-amplifier voltage < 10 mV. |
| W80 | Please calibrate machine newly | The automatic request of calibration is activated (See Chapter 7.2.1.1) and has fulfilled at least one of the conditions: <ul style="list-style-type: none"> • 30 minutes are passed since energizing. • Temperature of the pre-amplifier has changed more than 5°C since the last calibration. • Mass adjustments were changed. |
| W81 | CAL Factor too low | The calculated factor falls out of the valid range (<0,1). The old factor is retained. Possible fault cause: <ul style="list-style-type: none"> • The conditions for calibration have not been maintained. • The leak rate of the internal calibrated leak which was entered is much too small. • The internal test leak is defect. |
| W82 | CAL Factor too high | The calculated factor is out of the valid range (>10). The old factor is retained. Possible fault cause: <ul style="list-style-type: none"> • The conditions for calibration have not been maintained. • The leak rate of the internal calibrated leak which was entered is much too high or much too small. |

| <i>No.</i> | <i>Displayed Message</i> | <i>Description and possible solutions</i> |
|------------|---|---|
| W83 | All EEPROM parameter lost. Please check your settings. | <ul style="list-style-type: none"> • EEPROM on back plane is empty and was initialized with default valves. Enter all parameters again. • The EEPROM might be faulty when warning comes up again after power up. |
| W85 | Lost EEPROM parameter! Please check your settings! | <ul style="list-style-type: none"> • Writing access was interrupted. Please check all adjustments. • An update of software was done. In this case the notice can be ignored. • When warning comes up again after powering up the EEPROM might be faulty. |
| W86 | AC/DC factor too low | Calibration conditions not maintained Value of leak rate not entered correctly Test leak faulty |
| W87 | AC/DC factor too high | Calibration conditions not maintained Value of leak rate not entered correctly Test leak faulty |

9 Maintenance works

9.1 Hints

Maintenance works of level II and III at the UL5000 should be performed exclusively by a person authorized from INFICON GmbH in Cologne.

Key for the correspondingly repair level:

- I Repair level I Customer
- II Repair level II Customer with technical training
- III Repair level III INFICON service engineer



Warning

Please observe the security remark in this chapter.



Warning

Make sure the tools and the vicinity by working on vacuum systems are kept clean.



Danger

For all maintenance on the UL5000 the mains power must be disconnect first.



Caution

The UL5000 may be damaged due to lack of inspections.
In order to prevent subsequent damages, check the exterior of the SmartTest frequently relating to optical damages, and follow the Maintenance Instructions frequently.

Notice: Maintenance work must be performed as described in the following maintenance plan. If the maintenance rates will not be followed the UL5000 will loose the warranty.

A maintenance contract is recommended.

When it is time to maintenance the machine after 1500/4000/8000/16000/24000 hours it will be shown as a warning message at the display of the UL5000. The message will be displayed until the maintenance rate is met.

The 1500 hours maintenance can vary depending on the application of the leak detector.



Warning

Presumed Risk:

If it is to be assumed that safe operation is no longer possible, the device is to be taken out of service and secured against unsupervised operation.

Notice: This can e. g. be the case if:

- the unit has visible damage,
- fluid has gotten into the device,
- the device is no longer working,
- the device has been stored for an extended period of time under unfavorable conditions or
- after significant moving or transportation stresses



Warning

Oil can damage the environment. Therefore dispose the oil according to the local environment prescriptions.

9.2 INFICON Service

If equipment is returned to INFICON, indicate whether the equipment is free of substances damaging on health or whether it is contaminated. If it is contaminated also indicate the nature of the hazard. For this you must use a *Declaration of Contamination* form [Fig. 1-1](#) which has been prepared by us which we will provide upon request or you may copy the form which has been reproduced on the next to the last page of this handbook.

Please attach this form to the equipment or enclose it with the equipment.

This *Declaration of Contamination* is required to meet German Law and to protect our personnel. INFICON must return any equipment without a *Declaration of Contamination* to the sender's address.

9.3 Key for Maintenance Schedule

- I Repair level I Customer
- II Repair level II Customer with technical training
- III Repair level III INFICON service engineer
- X Perform maintenance work after operating hours or depending on time duration
- X₁ only operating hours, no limit of time
- X₂ Perform maintenance work depending on time duration
- 1 depends on environment and application
- 2 depends on process

9.4 Maintenance Plan

| Assembly | Required maintenance UL5000 | Operation hours/Years | | | | | Repair level | Part no. |
|----------------------------------|--|-----------------------|----------------|----------------|----------------|----------------|--------------|------------|
| | | 1500 | 4000 | 8000 | 16000 | 24000 | | |
| | | 1/4 | 1 | 2 | 3 | 4 | | |
| Vacuum system | | | | | | | | |
| Scroll pump Agilent TS 620 | Exchange the tip-seal | | | X ₁ | | | III | 200001671 |
| | Exchange the scrollmodule | | | | X | | III | 200000021R |
| Turbomolecular pump SplitFlow 80 | Replace the lubricant reservoir | | | | X ₂ | | II, III | 200003801 |
| | Bearing replacement | | | | | X ₂ | III | |
| Valve bloc | Clean the valves, replace seals for valves | | 2 | X | | | III | 200000594 |
| | Take apart the valve bloc and clean it | | | 2 | X | | III | 200000593 |
| | Replace filters for vent- and purge line | | 1 | X ₁ | | | I, II, III | 200000683 |
| | Adjust the Pirani | | | X | | | III | |
| Silencer | Exchange the silencer | X ₁ | | | | | I, II, III | 20099183 |
| Electric | | | | | | | | |
| Fans assembly | Clean fans at chassis plate and side wall e.g by pressurized air | 1 | X ₁ | | | | I | |
| | Exchange spare filter cell for fans chassis plate | 1 | X ₁ | | | | I | 20000685 |

*) every 2 years regardless of operation hours

9.5 Maintenance groups

The maintenance plan for the UL5000 can be subdivided in 4 maintenance groups.

- 1500 hours maintenance
- 4000 hours maintenance
- 8000 hours maintenance
- 16000 hours maintenance
- 24000 hours maintenance

9.5.1 1500 hours maintenance

The 1500 hours maintenance can be performed by an operator or a maintenance person.

The filter cell in front of the fans should be checked and replaced if dirty. By operating under worth conditions, the maintenance rates can be appropriately reduced.

Replace the silencer at the exhaust of the leak detector.

Notice: An obstructed silencer can lead to damaging the scroll pump

| Work to be performed | Required materials | P/N |
|------------------------------|--|-----------|
| Check and/or replace filters | <ul style="list-style-type: none"> • Spare filter cell for the fans | 200000685 |
| Replace silencer | <ul style="list-style-type: none"> • Silencer for the exhaust | 20099183 |

9.5.2 4000 hours maintenance

The 4000 hours maintenance should be performed by an INFICON service technician or another authorised person at least yearly.

Notice: The internal Helium standard leak certificate is valid for one year after delivery. The annual refurbishing of the internal Helium standard leak is recommended and an other certificate will be delivered. The internal Helium standard leak can be refurbished at INFICON GmbH in Cologne exclusively.

| Work to be performed | Required materials | P/N |
|---|---|------------------------------------|
| Replace the Lubricant Reservoir of the turbomolecular pump SplitFlow 80 (every 2 years) | <ul style="list-style-type: none"> Lubricant Reservoir for SplitFlow 80 | 200003801 |
| Check and/or replace Filters | <ul style="list-style-type: none"> Spare Filter Cell for the fans Spare Filter for venting and purge line Silencer for exhaust | 200000685 200000683 20099183 |
| Functional check and adjustment | | |

The maintenance work will take approximately 3 hours.

9.5.3 8000 hours maintenance

The 8000 hours maintenance should be performed by an INFICON service technician or an other authorized person.

After 8000 working hours, the „Tip Seal“ of the scroll module of the Agilent pump should be replaced by an INFICON service technician.

If the „Tip Seal“ has not been replaced, then after 12000 working hours the scroll module must be exchanged.

| Work to be performed | Required materials | P/N |
|--|---|-----------|
| Replace the Tip Seal (Agilent TS 620) | <ul style="list-style-type: none"> • Tip Seal | 200001671 |
| Restore the Lubricant Reservoir SplitFlow 80 | <ul style="list-style-type: none"> • Lubricant Reservoir for SplitFlow 80 | 200003801 |
| Replace the seals for valves | <ul style="list-style-type: none"> • Set of seals for valves | 200000594 |
| Check and/or replace Filters | <ul style="list-style-type: none"> • Spare Filter Cell for the fans | 200000685 |
| | <ul style="list-style-type: none"> • Spare Filter for venting and purge line | 200000683 |
| | <ul style="list-style-type: none"> • Silencer for exhaust | 20099183 |
| Functional check and adjustment | | |

The maintenance work will take approximately 6.0 hours.

9.5.4 16000 hours maintenance

The 16000 hours maintenance should be performed by an INFICON service technician or an other authorized person.

After 16000 working hours the bearings and the fore pump will reach their expecting life time. The scroll module Agilent TS 620 has to be replaced.

| Work to be performed | Required materials | P/N |
|--|---|------------------------------------|
| Replace scroll module | <ul style="list-style-type: none"> • Scroll module Agilent TS 620 | 200001665R |
| Take apart the valve bloc and clean it | <ul style="list-style-type: none"> • Set of seals for valve bloc | 200000593 |
| Replace the seals for valves | <ul style="list-style-type: none"> • Set of seals for valves | 200000594 |
| Check and/or replace Filters | <ul style="list-style-type: none"> • Spare Filter Cell for the fans • Spare Filter for venting and purge line • Silencer for exhaust | 200000685 200000683 20099183 |
| Functional check and ajustement | | |

The maintenance work will take approximately 10.0 hours.

9.5.5 24000 hours maintenance

The 24000 hours maintenance should be performed by an INFICON service technician or an other authorized person.

The turbomolecular pump SplitFlow 80 has to be replaced.

| Work to be performed | Required materials | P/N |
|--|---|------------|
| Replace turbomolecular pump SplitFlow 80 | <ul style="list-style-type: none"> • Turbomolecular pump SplitFlow 80 | 200003800R |
| Check and/or replace Filters | <ul style="list-style-type: none"> • Spare Filter Cell for the fans | 200000685 |
| | <ul style="list-style-type: none"> • Spare Filter for venting and purge line | 200000683 |
| | <ul style="list-style-type: none"> • Silencer for exhaust | 20099183 |
| Functional check and adjustment | | |

The maintenance work will take approximately 10.0 hours.

9.6 Description of the maintenance work

Only trained specialist staff can perform more changes at the UL5000 than the normally maintenance work.



Danger

The protective conductor screw at the chassis plate should not be loosened. The operator is not protected against electric shock by working without a protective conductor line.

9.6.1 Opening the UL5000

Required tool

Wedge (Accessories).



Danger

Disconnect the power cord from the UL5000 before opening the side cover.

- Separate the UL5000 from other vacuum components at the inlet port.
- Remove the side covers by using the wedge (Fig. 9-1). Push down the wedge to release the side covers.
- The location for the wedge is marked with two dot marks at the top side of the side covers (See Fig. 9-1/2).
- Open the both side covers in the same way.

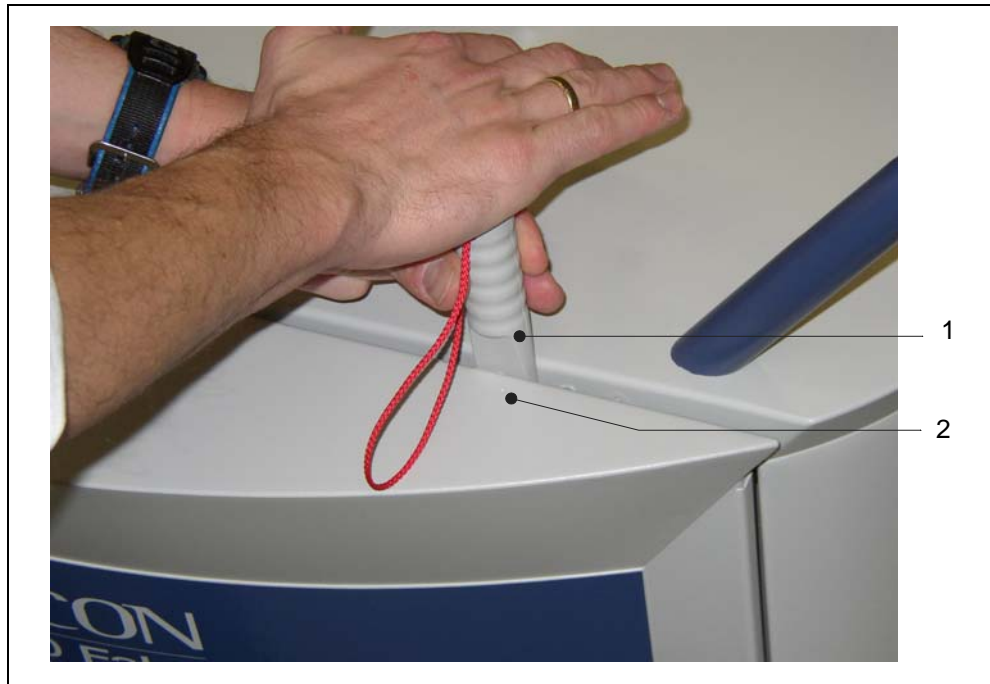

Fig. 9-1 Opening the UL5000

| | | | |
|------|-------------|------|-------------|
| Pos. | Description | Pos. | Description |
| 1 | Wedge | 2 | Side cover |

9.7 Check/Replace the filter cell

The filter cell in front of the fans should be checked every three months (under worth conditions monthly). If the filters cells are dirty then you should replced them. They allow to reduce the cooling power of the turbo pump and the leak detector.

Required tool

Wedge (Accessories).

Required material

Spare Filter cell P/N 200000685

Danger

Disconnect the power cord from the UL5000 before opening one of the side covers.

- Please refer to section 9.6.1 to open the unit.
- Catch the filter cell by using your two fingers (Fig. 9-2/a) and pull it out of the guide plate. You can also press the filter to the front with an appropriate tool throw the ejection drilling (Fig. 9-2/3) located at the back side.

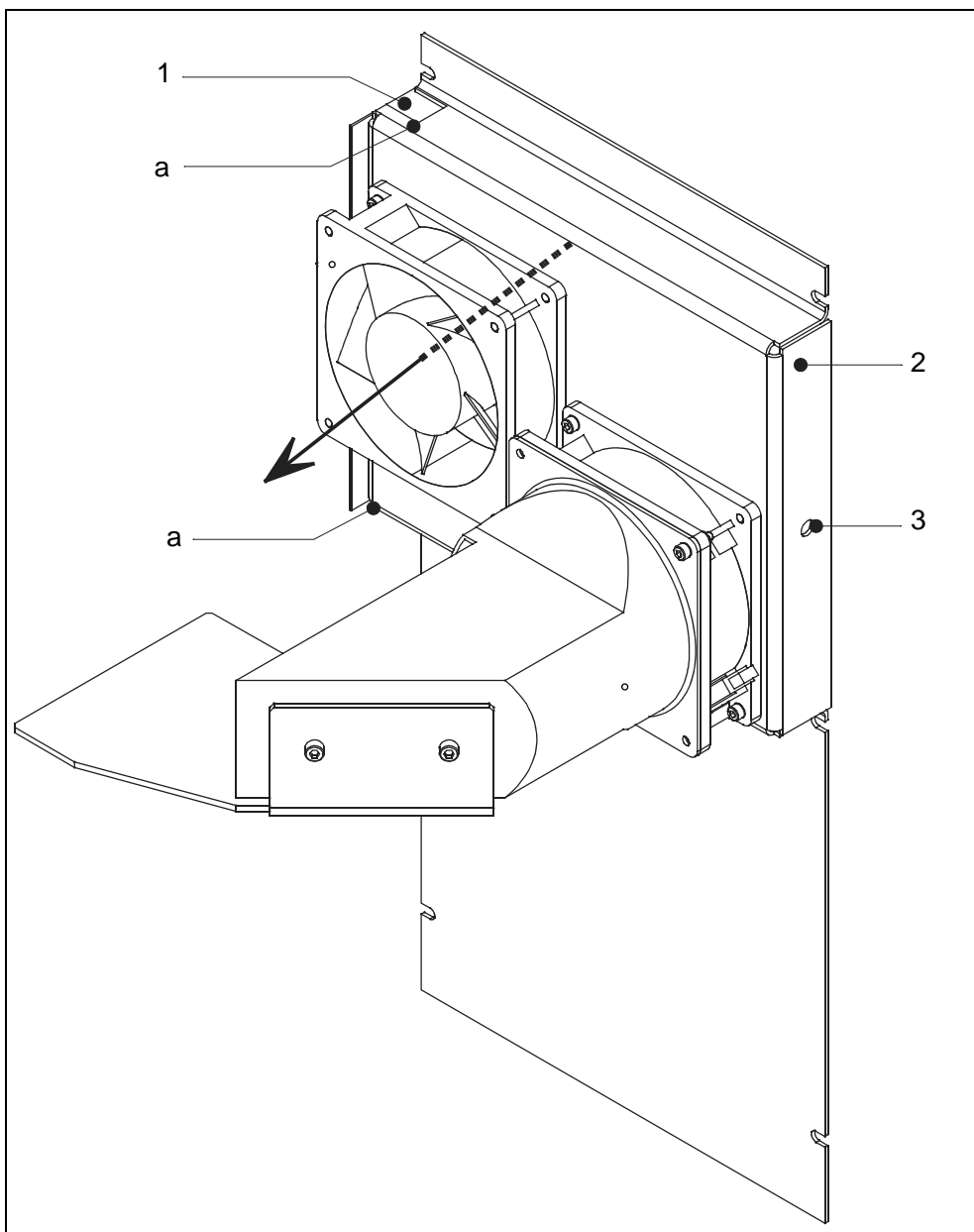

Fig. 9-2 Replace the filter cell

| Pos. | Description | Pos. | Description |
|------|---------------|------|--------------------------------|
| a | Filter handle | 2 | Guide plate of the filter cell |
| 1 | Filter cell | 3 | Ejection drilling |

- Observe the right direction by replacing the new filter cell. The direction is indicated in Fig. 9-2 with a black arrow.

Notice: The white surface of the filter cell which is marked with „clean air side“ must show towards the fans.

- Push the filter cell into the guide plate and close the UL5000 by pressing the side cover.

9.8 Replacing the Exhaust Silencer

Required material

Exhaust silencer P/N 20099183

- Switch off the UL5000.
- Unscrew the exhaust filter from the exhaust. Screw the new exhaust filter onto the thread of the exhaust and tight it.

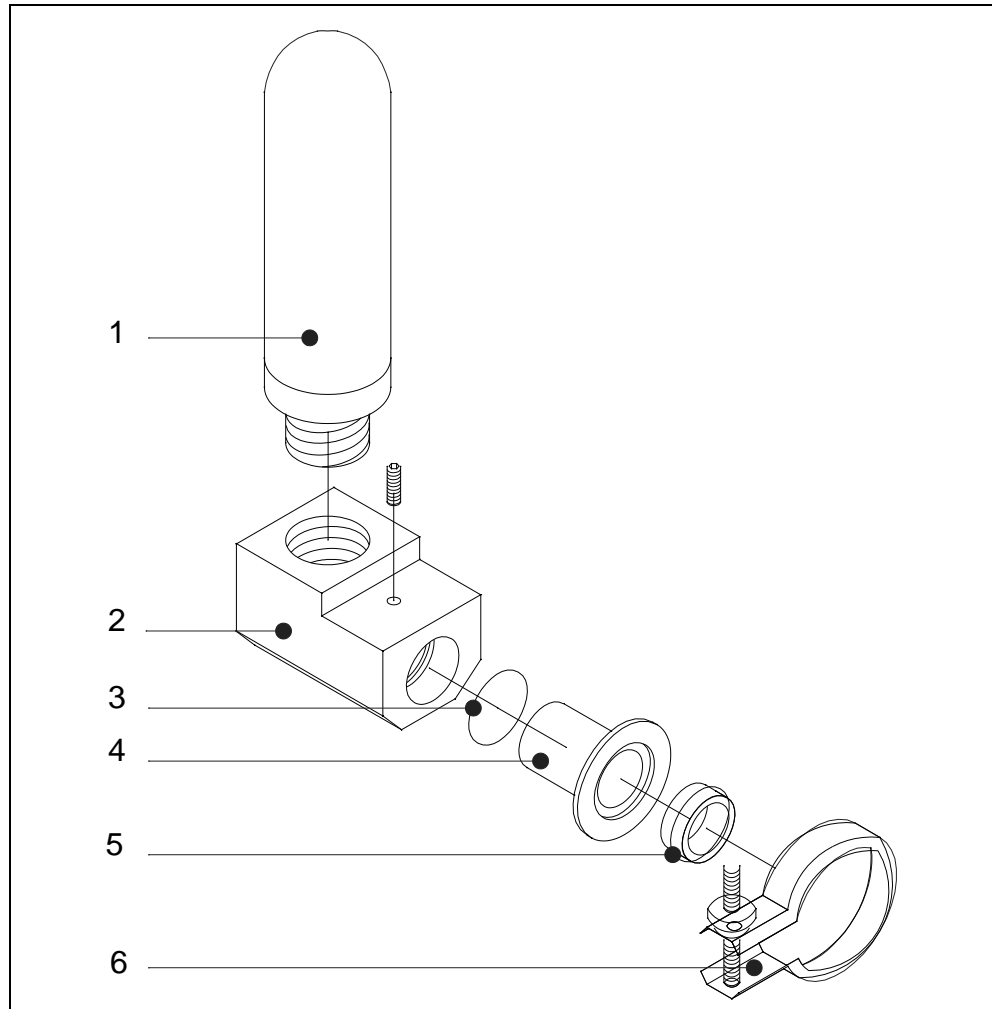

Fig. 9-3 Replacing the exhaust silencer

| Pos. | Description | Pos. | Description |
|------|------------------|------|----------------------|
| 1 | Silencer | 4 | Reducing piece |
| 2 | Silencer adapter | 5 | Centering ring DN 25 |
| 3 | O-Ring 20 x 3 | 6 | Clamping ring |

- Unscrew the hexagon screw from the bottom side of the plexiglas cabinet and drain off using an adequate vessel.
- Please turn in and tighten the screw after draining.
- Check the oil level of the rotary vane pump D16 Band fill it up if necessary.

9.9 Turbomolecular pump SplitFlow 80

The PFEIFFER turbomolecular pump requires a maintenance every three years, independently of the number of working hours.

Please refer to the PFEIFFER operating instructions PT 0217 BN/D (1211) and PT 0208 BN/I (1504) for more detailed informations. The maintenance work should be performed by the INFICON service or an authorized INFICON service partner.

9.10 Scroll Pump

Take the maintenance rates of the scroll pump Agilent from the maintenance plan in chapter [9.4](#).

The maintenance of the scroll pump should be exclusively performed by the INFICON service or an authorized INFICON service partner.

10 Declaration of Conformity



EU Declaration of Conformity

We – INFICON GmbH - herewith declare that the products defined below meet the basic requirements regarding safety and health and relevant provisions of the relevant EU Directives by design, type and the versions which are brought into circulation by us. This declaration of conformity is issued under the sole responsibility of INFICON GmbH.

In case of any products changes made without our approval, this declaration will be void.

Designation of the product:

Helium Leak Detector

Models: **UL 5000**

Catalogue numbers:

**550-500
550-501**

The products meet the requirements of the following Directives:

- **Directive 2011/65/EU (RoHS)**

Applied harmonized standards:

- **DIN EN 50581:2013**

Cologne, July 26th, 2017



Dr. Döblér, President LDT

Cologne, July 26th 2017



Bausch, Research and Development

INFICON GmbH
Bonner Strasse 498
D-50968 Cologne
Tel.: +49 (0)221 56788-0
Fax: +49 (0)221 56788-90
www.inficon.com
E-mail: leakdetection@inficon.com

Index

| | | | |
|---------------------------------|-------|-----------------------------------|--------|
| A | | H | |
| Accessories | 21 | Hand Set | 21, 25 |
| alarm | 54 | Helium leak rate | 11 |
| Ambient temperature | 12 | Humidity | 12 |
| Audio alarm | 12 | | |
| Automatic Internal Calibration | 77 | I | |
| | | I CAL | 68 |
| | | information | 73 |
| | | Inlet area background suppression | 60 |
| | | Inlet port | 11, 26 |
| | | Inlet pressure | 11 |
| | | Installation | 16 |
| | | Ion source | 11 |
| | | ion source | 33 |
| B | | L | |
| background | 48 | language | 67 |
| built-in leak standard | 76 | Leak rate | 11 |
| | | loud speaker | 42 |
| C | | M | |
| Calculate Inlet Area Background | 61 | Machine factor | 60 |
| calibration | 28 | maintenance contract | 9 |
| contract | | Manual Internal Calibration | 77 |
| • maintenance and service | 9 | Mass spectrometer | 11 |
| contrast | 48 | mass spectrometer | 33 |
| Control Panel | 34 | Measurement range | 11 |
| | | MENU | 34 |
| | | menu | 50 |
| | | Mode | |
| | | • Sniffer | 11 |
| | | • Vacuum | 11 |
| D | | N | |
| Detectable masses | 11 | Noise level | 12 |
| Digital In | 23 | | |
| Digital Out | 21–22 | | |
| Dimensions | 12 | | |
| E | | P | |
| Electrical Connections | 19 | password | 73 |
| Exhaust | 26 | Pinpoint | 54 |
| exhaust filter | 67 | | |
| external calibration | 77 | | |
| F | | | |
| FINE | 38 | | |
| FINE only | 58 | | |
| G | | | |
| GROSS | 38 | | |

| | | | |
|------------------|--------|---------------------|--------|
| Power | | Storage temperature | 12 |
| • consumption | 12 | | |
| • supply | 12 | T | |
| pressure | 33 | Temperature | |
| Pumping speed | 11 | • ambient | 12 |
| Purge | 21, 26 | • storage | 12 |
| Purging | 41 | time axis | 43 |
| Purpose | 10 | Time&Date | 67 |
| | | Transportation | 16 |
| | | trend mode | 43 |
| | | Trigger | 42 |
| | | Trigger alarm | 54 |
| | | turbo pump | 38 |
| | | turbomolecular pump | 33 |
| Q | | U | |
| QT100 | 39 | ULTRA | 38 |
| | | ULTRA only | 58 |
| R | | V | |
| Recorder | 21, 24 | Vacuum Diagramm | 32 |
| Relay Output | 51 | Vacuum mode | 11 |
| RS232 | 21, 25 | Valves | 12 |
| run-up mode | 40 | Vent | 21, 26 |
| Run-up time | 11 | volume | 52 |
| S | | W | |
| Safety Symbols | 6 | Weight | 12 |
| scroll pump | 38 | Z | |
| service | 73 | Zero | 62 |
| service contract | 9 | ZERO Button | 30 |
| Setpoint | 54 | | |
| sniff mode | 39 | | |
| sniffer line | 32, 39 | | |
| Sniffer mode | 11 | | |
| START Button | 29 | | |
| Startup | 28 | | |
| STOP Button | 30 | | |

