Catalog

Chapter I	function introduction.....	1
	1、Cable fault locator technical data.....	1
	2、Path analyzer technical specifications.....	2
	3、Cable fault locator panel.....	2
Chapter II	Management system software introduction.....	4
	1、Cable test management system host	4
	2、Cable test management system panel.....	5
Chapter III	Cable fault test procedure.....	9
Chapter IV	Test methods introduction.....	10
	1、Cable fault Test Principle.....	10
	2、Low voltage pulse method.....	10
	3、Impulse flashover voltage method.....	14
	4、Flashover voltage method.....	16
	5、High-voltage flashover test Note.....	18
Chapter V	accessory	19
Chapter VI	Introduction for audio and magnetic signal digital display synchro-location device	20
Chapter VII	Introduction of cable route test Application Detect the route and depth of cable.....	24
Chapter VIII	Introduction for the fundamental of path-seeking device.....	26

Warning:

Don not use the notebook surf on internet unless in cable fault testing. Please charge the computer if you did not use the device for half a year. Open the host box is strictly prohibited without permission

When you use impulse flashover voltage method test the cable, the fault point will discharge and light, so this method is not allowed used in the environment of high gas and high concentrations of flammable gases. Please contact our company in case of such situation. We are not responsible for such incidents.

Chapter I function introduction

Introduction:

CABLE FAULT LOCATOR integrated industrial embedded computer platform, Network Communications Service and USB communication system to improve the utilization of the device. Specially, the device has loaded a system for underground buried cable data save and meet the national standard of 《DL/T849.1~ DL/T849.3-2004》. The device consists 3 parts: main system, fault locator and cable line tester. It is used for cable fault location, cable line and depth test and daily maintenance of cable data. It can also be used for signal cable fault location for railway station and airport.

Features:

- ◆ We are the first company in China who use industrial embedded computer platform system into cable fault locator. Lithium-power supply affords the convenience of field tests.
- ◆ We are the first company in China who use 12.1 inch touch-screen and windows XP system.
- ◆ The device adopt USB communication interface. The host can select 5 sampling frequency automatically between 6.25 MHz to 100MHz for the cable of different length.
- ◆ The device can search the fault point and display the distance automatically, the movement of double cursor can be accurate to 0.15m. The waveform can be compressing or expanding freely. At the same time the system will display two waveforms randomly which is close to standard waveform for your reference.
- ◆ The device saves total 40G waveforms and on-site wiring diagrams for your reference.
- ◆ We developed smart modular sampler to replace the on-site wiring, the sampling is totally separated with high-voltage to ensure the safety of the operator.

We developed HP-G35 high frequency high voltage power supply (8.9Kg) to replace the testing transformer and operation box (65Kg).

1、Application:

- ◆ can be used for test cable fault for different voltage levels, different sections and different

medium, including open circuit, short circuit, low resistance, high resistance leakage, high resistance failure flashover.

- ◆ can be used for testing signal cable fault for railway station, airport.
- ◆ can be used for testing wave propagation speed of the cable which length is known.
- ◆ can be used for testing the cable route and depth.

Display mode: 12.1 inch LCD (Windows XP)

Memory mode: Fixed and movable 20G/2G

Test methods: Low-voltage pulse method, impulse flash-over circuit method, flashover voltage method

Test distance: no less than 40km

The shortest testing distance (blind zone):5-10m

Location error: $\pm 0.2\text{m}$

Testing error: less than $\pm 1\%$

Sampling frequency: 6.25MHz、10MHz、25MHz、50MHz、100MHz、(self-adaption)

Power: AC 220V $\pm 10\%$ DC 12V (7AH)

Maximum power endurance: 4 hours

2、Path analyzer technical specifications:

Signal frequency: 15KHz sine wave

Output power: $P_{\text{max}} \geq 100\text{W}$

Output impedance: $Z_o = Z_c$

Vibration mode: incontinuous

Host Weight: 9.8Kg

Ambient temperature: $-10^\circ\text{C} \sim +40^\circ\text{C}$

Overall dimension: 180mm \times 300mm \times 400mm

Relative humidity: $\text{RH} \leq 85\%$ (25°C)

3、Testing panel

Please see the diagram below:

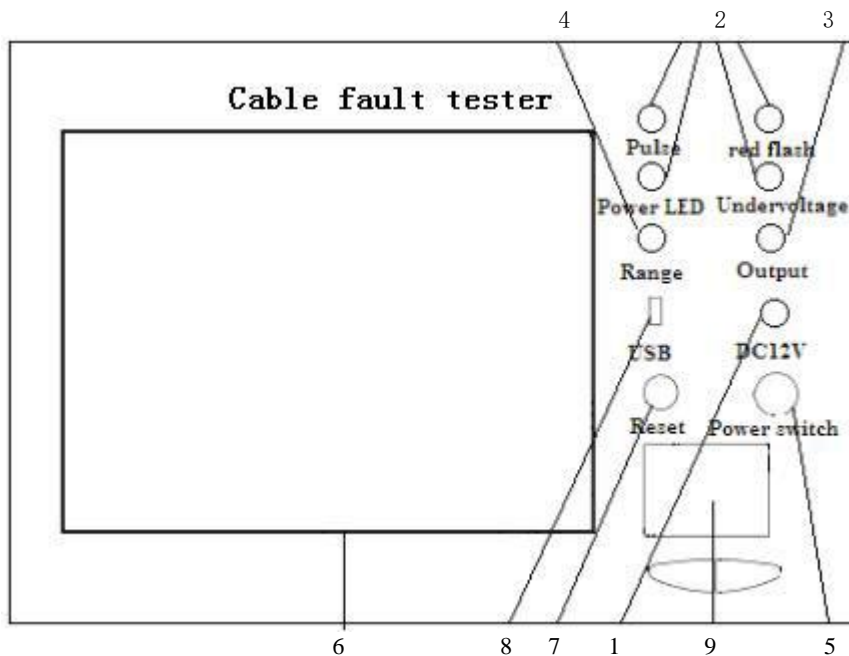

1 Power plug: The device uses 50Hz, 220V A/C power supply.

2 Indicator light:

Power LED: Red light shows charging status and green light shows full-charge status. Fully charging normally needs 12 hours.

Under-voltage : Red-LED will light when under voltage and alarm will sounds at the same time. If the host displays short voltage, please shut down the device and charging by 220V. After 30 seconds, you can restart the device.

Pulse : Green-LED will light after start and work status will be pulse method.

Red flash: Red-LED will be light after start and work status will be impulse flashover method.

3 Output plug: BNC-50KY (Q9) plug for signal output.

4 Range: This button is used for adjusting input and output amplitude. The adjustment should be in accordance with the display waveform. If the adjustment is insufficient, the impulse reflection is too small to get a waveform sample.(see pic 3). If the adjustment is excessive, there is no intersection between reflection impulse and datum line(see pic 4).Generally, wresting the button for about 1/3 round, then sample again in accordance with the waveform.

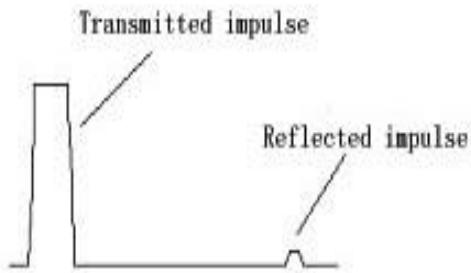

Pic 3



Pic 4

5 Power switch: Start the host system. Please shut down windows xp in normal procedure.

6 LED: is not touch-screen, please click by the mouse.

7 Reset: Refresh the testing program. Please press this button after start the system and the pulse signal will shine for one time, and test program will be in procedure. This button can also be use to refresh the system in case of log port error during the test.

8 USB interface: Can save, analysis and print the testing data and test waveform by computer.

9 Touch-control mouse: normally use in WINDOW XP system.

Chapter II Management system software introduction

1、Cable test management system host

- ◆ Start the system.
- ◆ Click the “Cable test management system” and it will be show “cable fault test”, “cable data management” and “exit” three parts.
- ◆ Please shut down the windows xp system according to normally procedure. Please shut down the “switch” at last.



2、Cable test management system panel

Click “cable fault test” button and enter into testing panel. There will be four parts: menu bar, status bar, graphical displaying area and functional button area.

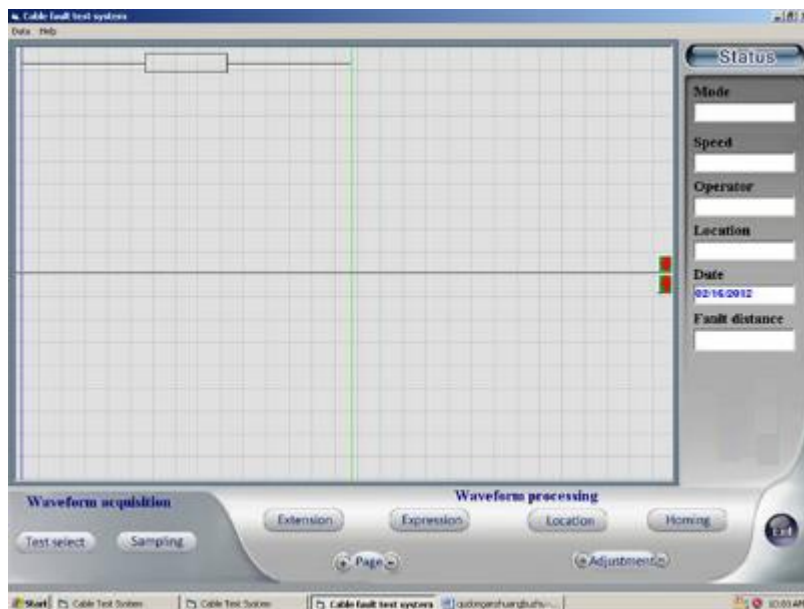

◆ menu bar

1) data management

Data management includes “save”, “read”, “testing report” and “exit” four parts.

Select “save” menu to save the waveform and test data. Select “read” menu to read out the

waveform saved before. Select “testing report” to creating a “cable fault testing report”.

2) test help

Test Help includes two parts, “Help” and “About”.

Select “about” menu, you can check the contact information of our company, and visit our website and ask our technicians for on-line help. You can also email us if you have difficulties in analysis waveform.

Select “help” menu for connect the manual book.

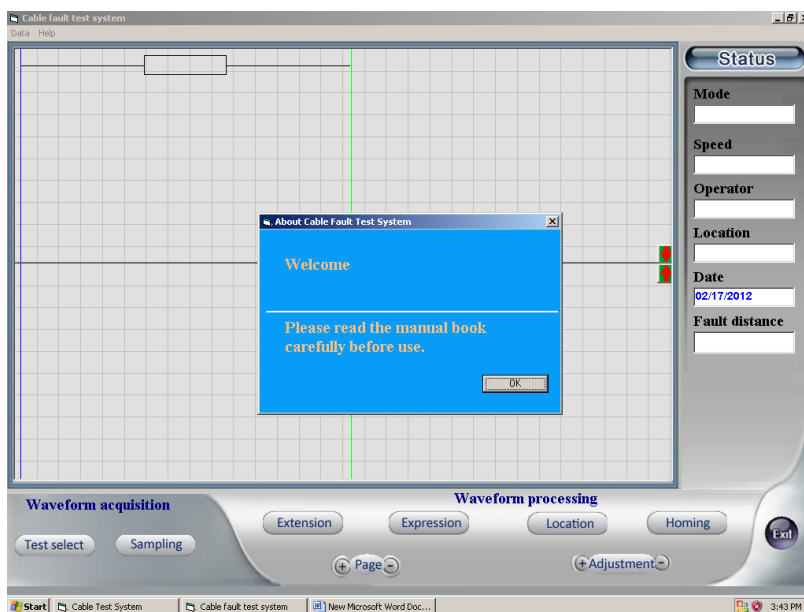
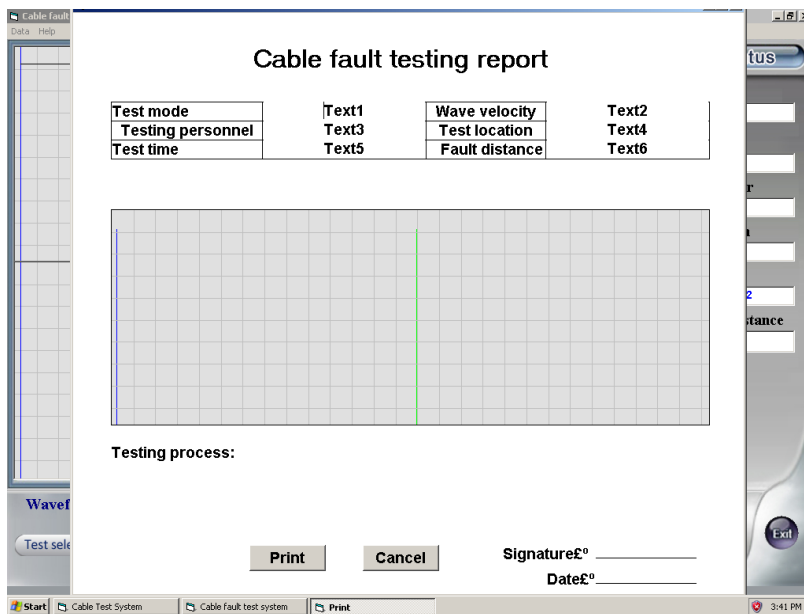

◆ work status menu

This menu including five parts: “testing methods”, “wave speed”, “operator”, “location” and “time”. The information mentioned above will be displayed automatically according to your selection. You only need input “operator” and “location”.

◆ graphical displaying area

This menu displays the waveform you sampled. It will display two waveforms during testing at the same time. You can also sample more standard waveform and make contrast in same screen or making separate analysis by clicking the arrow in the right of the screen central line.

◆ functional buttons area

There are eight buttons in this menu.

1) test selection button

You can select “test mode”, “range and sampling frequency” and “Medium” in this menu.

There are two sub-menus, “cable fault test” and “speed test”. You need input the length of the cable when you select “speed test”.



Test methods menu including three sub-menus: low voltage pulse method, impulse flashover voltage method and flashover voltage method

Sampling frequency: The sampling frequency will be adjusted automatically according to the

length of the cable. You can select the length below according to your situation:

- $5\text{m} < L < 615\text{ m}$ Sampling frequency 100MHz
- $615\text{m} < L < 1229\text{ m}$ Sampling frequency 50MHz
- $1229\text{m} < L < 2458\text{ m}$ Sampling frequency 25MHz
- $2458 < L < 4915\text{ m}$ Sampling frequency 10MHz
- $4915\text{m} < L < 50000\text{m}$ Sampling frequency 6.25MHz

Medium selection:

- oil impregnated paper $V=160\text{m}/\mu\text{S}$
- non-drain $V=144\text{m}/\mu\text{S}$
- crosslinked polyethylene $V=172\text{m}/\mu\text{S}$
- PVC $V=184\text{m}/\mu\text{S}$
- others $V=***\text{m}/\mu\text{S}$

If the wave speed is not included above, please enter by yourself.

2) Sampling button:

The system will sampling one time if you press this button and will display in Graphic displaying area.

3) Expand button:

This button can expand the waveform to the right size for your analysis.

4) Compress button:

This button can compress the waveform to the right size for your analysis.

5) Location button:

You can use blue cursor setting initial point by this button, then move the green cursor to the fault point you chosen, the distance will be displayed automatically.

6) Return button:

You can return the blue and green cursor to original position for re-located.

7) Page button:

This button can move the waveform to the centre of screen to find out the best knee point.

8) Adjusting button:

This button can help you make fine-adjustment in locating the knee point by blue and green cursor.

9) Exit: exiting the testing system.

Chapter III Cable fault test procedure

We suggest you follow the procedure below in cable fault testing:

- 1 Understand the cable type, analysis the Fault Property of cable.
- 2 Measure the length of the cable by low voltage pulse method, check the wave speed.
- 3 choose appropriate test method make rough testing.

For different cable fault, you should choose the corresponding methods. Generally speaking, low-resistance fault (open circuit, short circuit) can be tested by low voltage pulse method, high-resistance fault (leakage, flashover) should be tested by flashover method.

fault	resistance	Break-down situation
Open circuit	∞	Can be break-down by DC or high voltage impulse
Low-resistance	Lower than $10Z_0$	Can be break-down by high voltage impulse if the resistance is not very low
High-resistance	higher than $10Z_0$	Can be break-down by high voltage impulse
flashover	∞	Can be break-down by DC or high voltage impulse

Note: Z_0 is the characteristic impedance value, generally, electric power cable Z_0 between 10 to 40Ω .

You should pay attention to the wire connection and the DC high voltage added when you use high voltage flashover method. The maximum voltage withstanding for oil paper cable and crosslinked polyethylene cable is 50KV and 35 KV, generally, you can not exceed these levels. The ground wire of high voltage device should be connected with the lead sheathing of the cable tested.

4 Test the path of the cable by cable line tester.

5 locate the fault point by our device.

Connect the high voltage device by fixed point discharging method, set the voltage boost level according to cable type.

Chapter IV Test methods introduction

1、Cable fault Test principle

According to TDR theory, we can derive a formula below:

$$S=VT/2$$

In this formula, S represents the distance from the testing terminal to the fault point. V represents the electric wave transmission speed in cable, T represents the time of electric wave transmitted for a round trip in the cable. So we only need to test the V and T then can calculate the distance by the formula mentioned above.

We will introduce three test methods below: low voltage pulse method, flashover voltage method and impulse flashover voltage method.

2、Low voltage pulse method

This method is used to test the electric wave transmit speed, cable length, low-resistance fault (resistance value in fault point is below 1k), open circuit fault and short circuit fault.

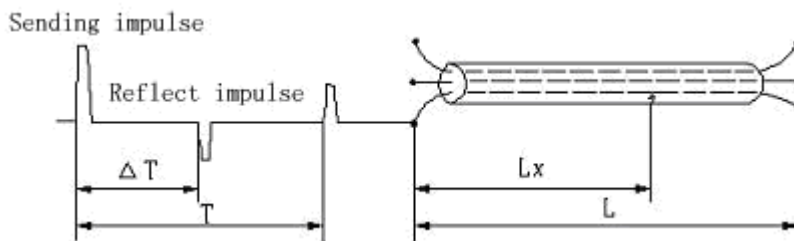

Low-voltage impulse test method schematic diagram

When you add electric impulse to cable, it will transmitting along the cable in a certain speed(depends on permittivity and permeability) and will be reflected in fault point, in this time the flash tester will record the transmission time ΔT . Then we can

calculate the distance of the point Lx by the formula we mentioned above.

We can judge the fault property by the waveform. When the reflected impulse is in phase with transmitting impulse, the fault is short circuit fault or terminals open circuit. If in reversal phase, the fault is short circuit grounding or low-resistance fault.

Please connect the cable fault phase and grounding wire with input line of the testing system (another end of the input line connected with Q9), then connect the tester with notebook by USB interface, operating the testing software for testing.

◆ Testing speed

To some cable, the wave transmission speed is unknown, we can test it if we know the length of the cable.

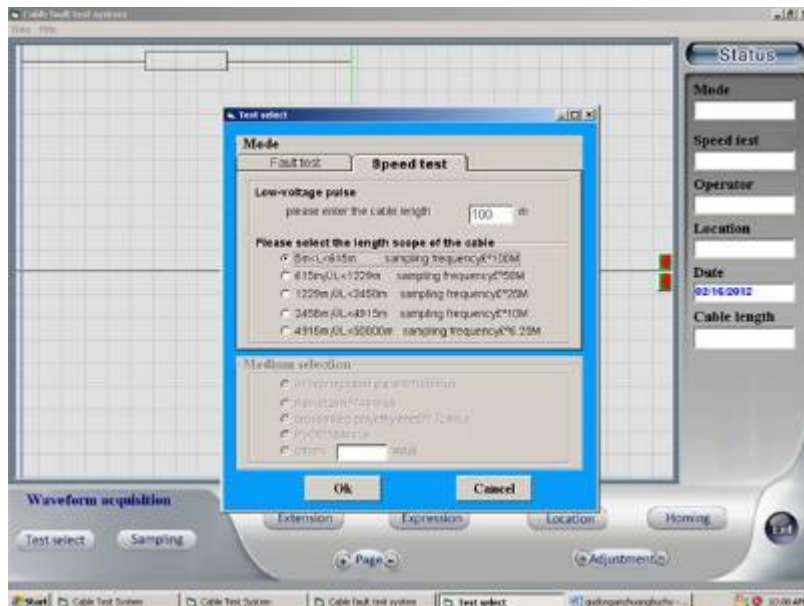

You should enter the length of the cable by the keyboard marked as “#” in the taskbar in lower left when you test speed. Please adjust the waveform by functional button according to your requirement. In case of error occur, please re-start the system by “return” button, then you can re-sampling and make analysis. Please adjust the blue and green cursors to the proper position, the result will be displayed automatically in “testing result area”.

◆ Testing fault

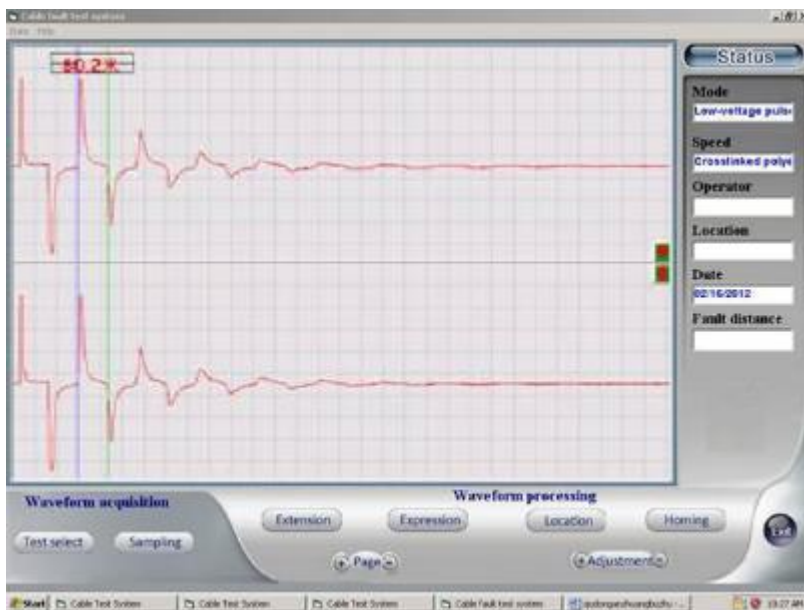
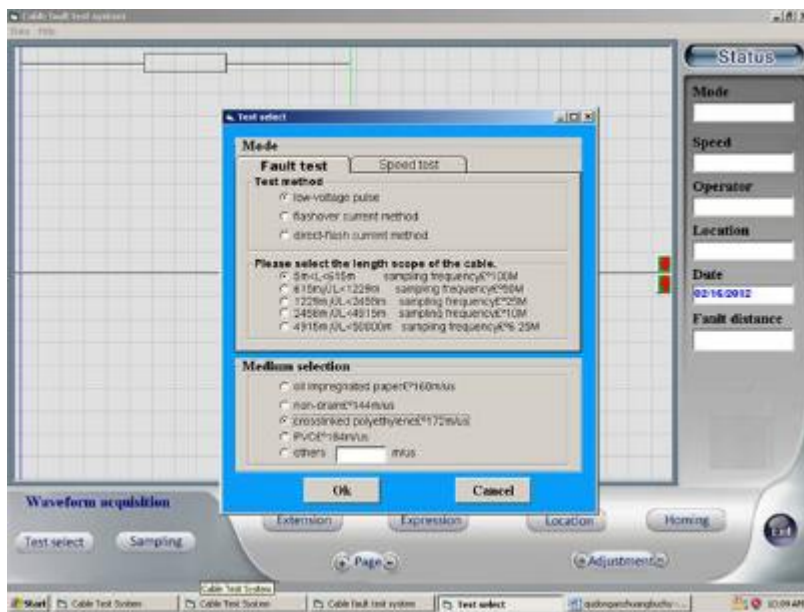

When you test fault by low voltage pulse method, please select the length of the cable, then click “confirm” and “sampling” button, the waveform will be displayed in the “testing result area”.

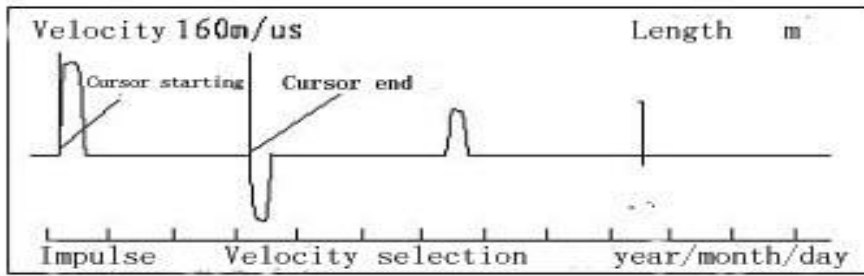

Waveform for L.V impulse test short-circuit and low-resistance fault

The polarity of the transmitting pulse is same to the open circuit echoed signal but opposite to the short circuit echoed signal. So the starting point and terminal point of the cursor should be set in the crossing point of pulse rising edge with baseline.

The waveform is as below when you test open circuit fault and short circuit fault by low voltage pulse method.

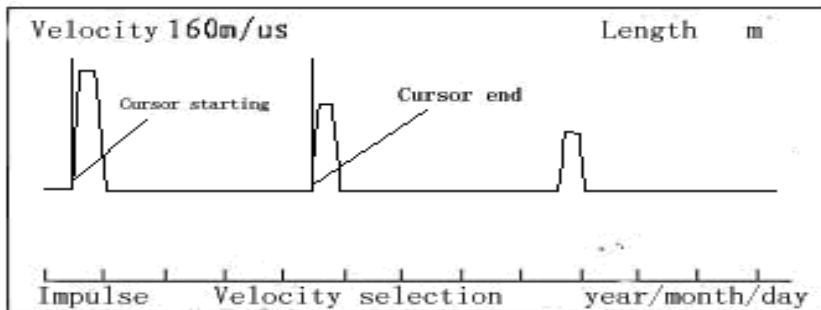

Low-voltage pulse measuring a total length of the waveform (open terminal)

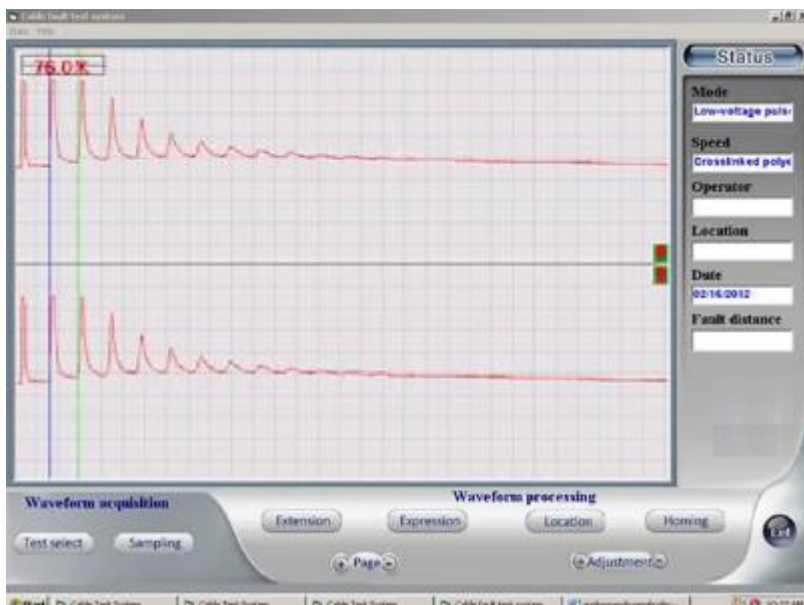

◆ Test length is same to test fault:

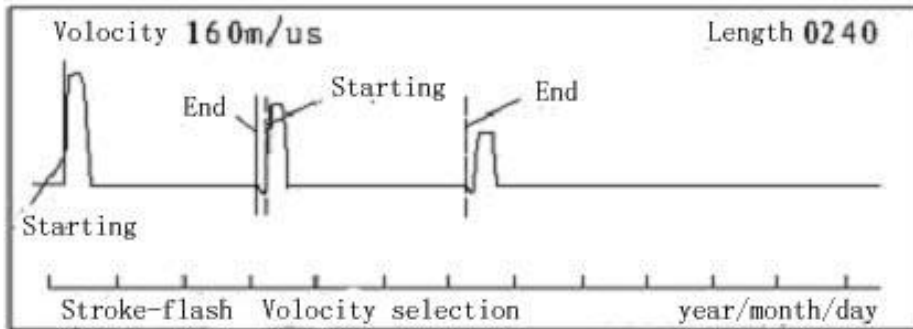

Waveform for strok-flash current sampling

3 flashover voltage method

The definition High resistance fault is that the DC resistance in fault point is high than the natural impedance of the cable. Over 90% of cable fault is high resistance fault and most of them can be tested by flashover voltage method. This method can be divided into two kinds: Impulse flashover voltage method and flashover voltage method.

We recommend you adopt electric current sampling methods. Please connecting lines according to wiring diagram, then select/enter transmitting speed. Please adjust the input amplitude slightly (1/3 position) and start sampling.

After you adjust the sphere gap and input amplitude, please rise the voltage gradually to certain level, the fault point will discharge and the device will record the waveform automatically. Please repeat this procedure until you get good sample. In case of error occur, please re-start the system by “return” button, then you can re-sampling and make analysis.

Note: adjusting 1mm of sphere gap represents 3kv, please adjust properly according to tested cable voltage level.

Generally, transmitting pulse is positive, echo pulse is also positive but leading edge is negative. Amplitude of negative echo pulse is much lower than positive pulse.

Please set the blue cursor to the crossing point of positive pulse rising edge with baseline and green cursor to the crossing point of negative echo pulse falling edge with baseline. Please adjust the waveform and cursors by functional buttons according to your requirement. In case

of error occur, please re-start the system by “return” button, then you can re-sampling and make analysis. The result will be displayed automatically in “testing result area”.

If no negative echo pulse, then please set the terminal cursor to the crossing point of echo pulse rising edge with baseline, the fault distance will increase 10%. You should subtract these 10% for precisely location.

Please return the cursors by “return” button.

Waveform and wiring diagram:

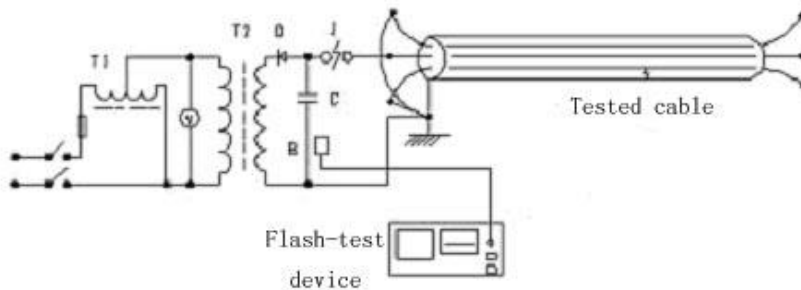
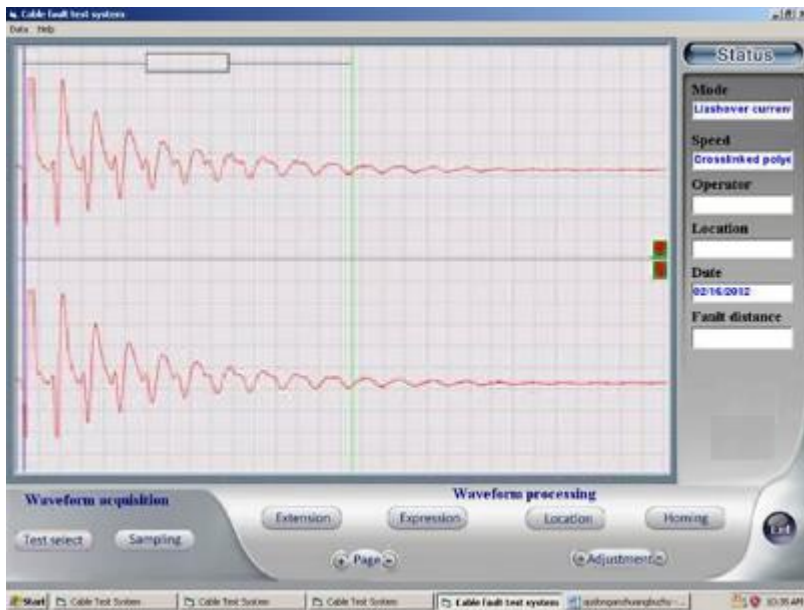

Connection diagram for strok-flash current sampling

Notes: T1、 represents 3KVA/0.22KV voltage regulator

T2、 represents 3KVA/50KV high voltage DC/AC transformer

D、 represents high voltage silicon rectifier stack, over 150KV/0.2A

C、 represents high voltage impulse capacitor, capacity is $1 \sim 2 \mu\text{F}$, withstand voltage is lower than 40KV

V、 represents voltmeter.

B、 represents current sampler. (accessory)

Warning: please connect the high voltage discharging bar with high voltage ground wire before testing.

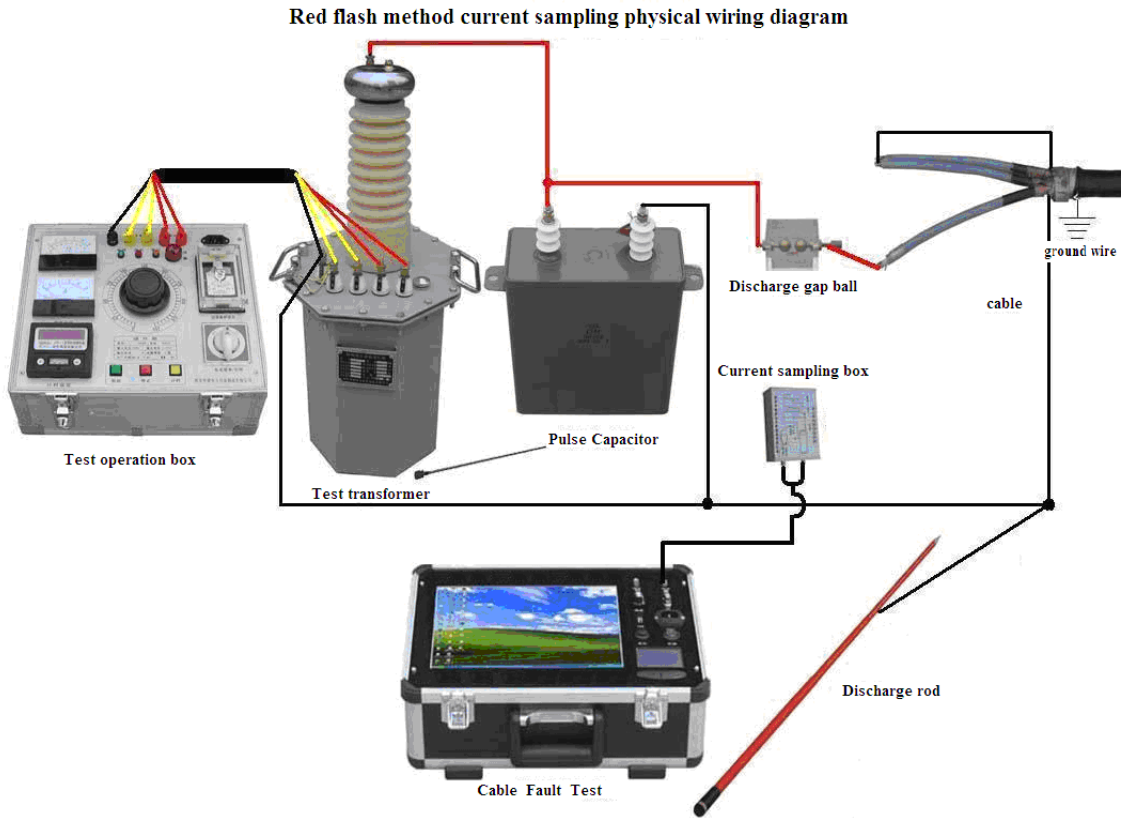

4 flashover voltage method

Flashover voltage method is used for testing high resistance flash fault. In actual test, operation and diagram is same to impulse flashover method (no sphere gap). Flashover voltage can also be divided into voltage sampling and current sampling, we recommend you current sampling.

Warning: please keep watch on high voltage current in case burning out transformer.

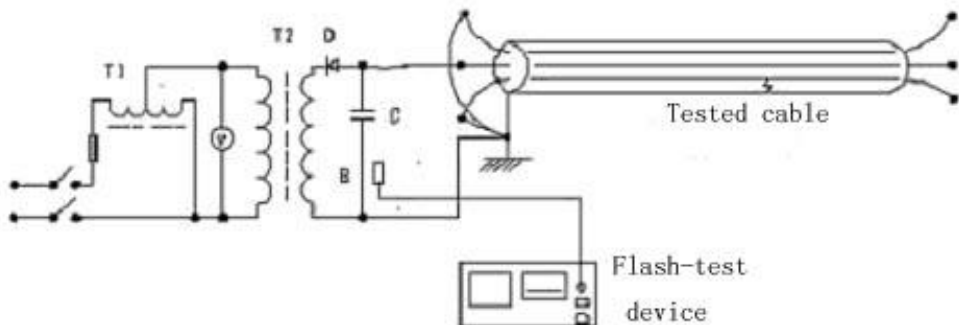

Connection diagram for H.V flash method

(1) Waveform when fault near to testing terminal

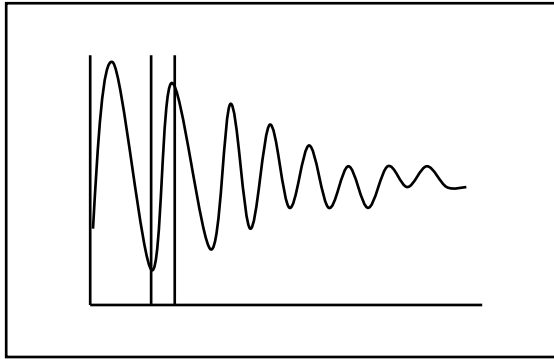

(a) close

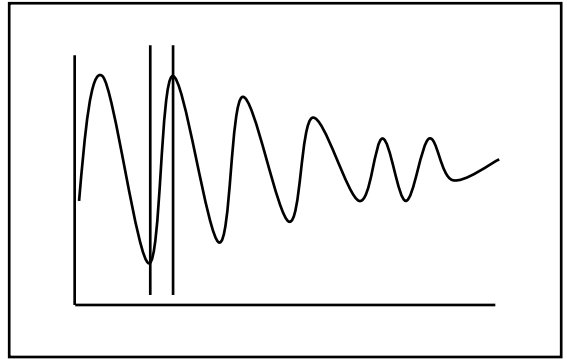

(b) near

(2) Waveform when fault in the middle of the cable

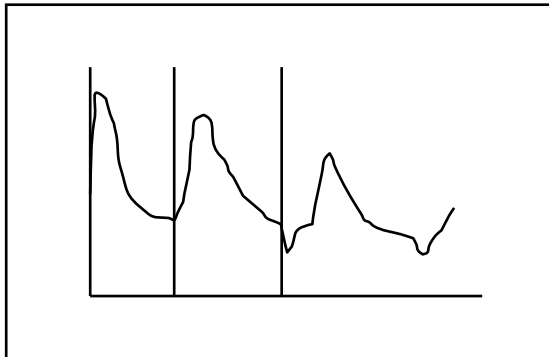

(a) near

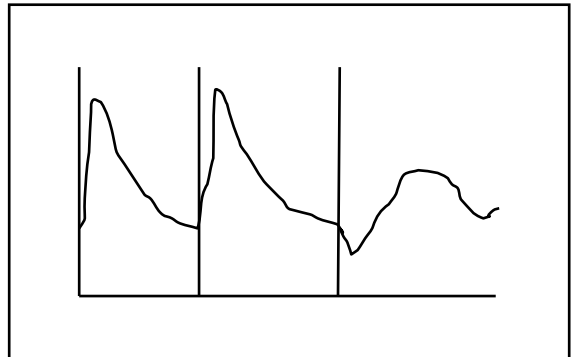

(b) far

(3) Waveform when fault near to testing terminal

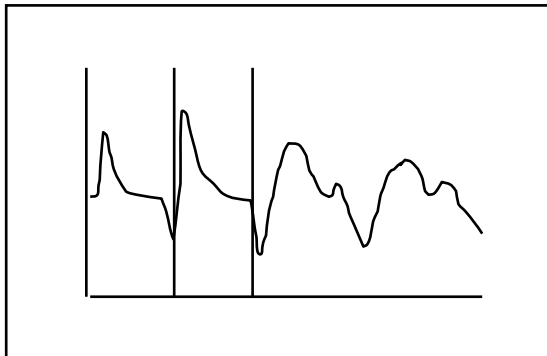

(a) short cable

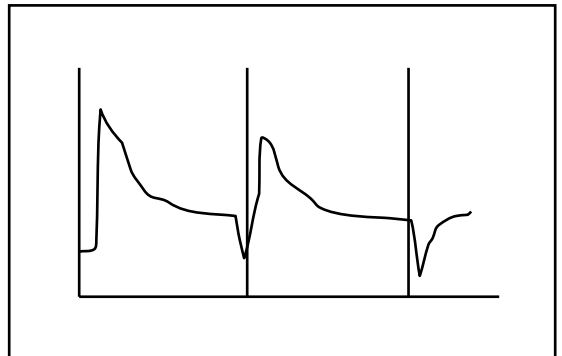

(b) long cable

(4) Regular waveform sampled by flashover voltage method

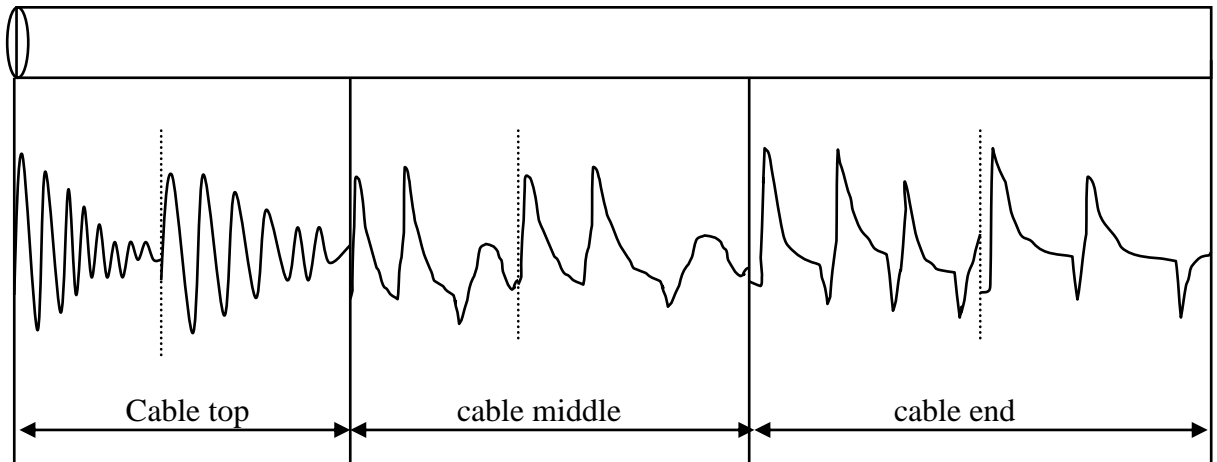

5 High-voltage flashover test Note:

Due to high voltage, you should pay special attention to the following points when use flashover voltage method.

- (1) Testing devices should be operated by professionals. Please make sure the device is earthed well. When you make adjustment, please make sure power is off and thoroughly discharged.
- (2) The power source of high voltage equipments should be separated from testing devices. The connecting line should be far away from high voltage lines. When start testing, you should cut off external power connection and mouse.
- (3) High voltage end, control box and ground terminal must connected with the cable sheath and earth ground to ensure equipment and personal safety.
- (4) Make sure you selected flashover voltage method or impulse flashover method before testing. Wrongly choice may damage the device.
- (5) Please add voltage to fault cable to make sure all connection lines/points are not discharging before test. when you start testing, make sure the fault point already start discharging.

(6) There should be some protecting measures if work in a flammable environment.

Chapter V accessory

1 current sampler

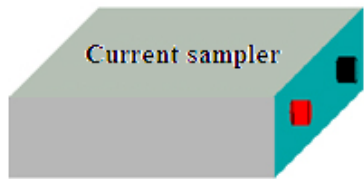

Appearance in Figure

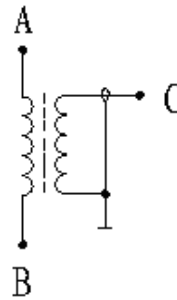

Wiring diagram

Shape diagram and wiring diagram of the current sampling

When you use high voltage flashover method, please connect the terminals of current sampler with binding post of testing line in same color, and place the current sampler 3-5cm away from the capacitor grounding line in parallel.

2 Connecting cable

Connecting cable is used for flashover method and low voltage pulse method.

Connect stroke-flash device



Connect cable to be tested

Schematic diagram for connect cable

3 wiring diagram of precise location

After the rough testing, please connecting the lines according to the diagram below, then add

high impact voltage to the cable to let the fault point discharging continuously, the frequency 3~4 seconds every time. Take the audio-magnetic synchronous locator to the fault point (rough testing result) 10m before and after to listen to the discharging noise, the loudest point is fault point.

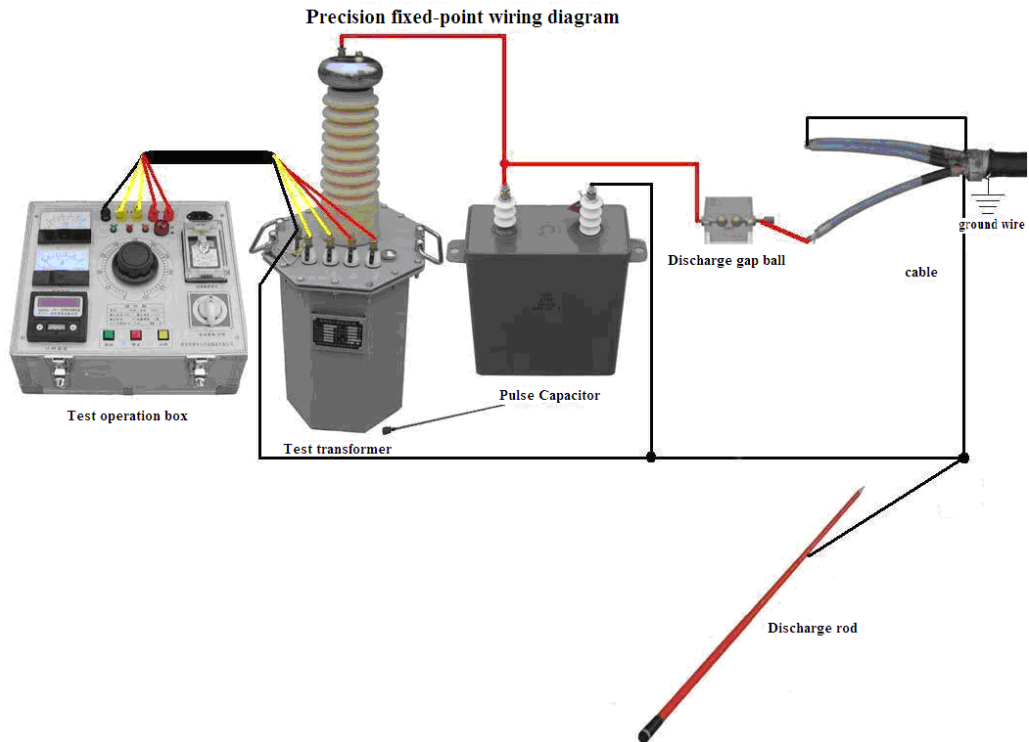

Chapter VI Introduction for audio and magnetic signal digital display synchro-location device

1 Application:

This product is used for testing the faults of buried cable fast and precisely, meanwhile, it can be used for detecting the buried path and depth of a cable.

2 Main features:

1) Adopt special structure sounding-wave vibration transducer and low noise exclusive part as a pre-amplication device to boost the sensitivity of the location and path-seeking greatly. In signal processing, digital display of the distance between the fault and the sensing probe enhance the efficient of location greatly.

2) For overhead cable, only by connecting the transducer probe of our device to the fault cable or adjacent cable, the distance and the direction of the fault spot can be located easily and precisely.

3) Power frequency adaptive cancellation theory and hi-Q power frequency trapped wave technology increase the restrain and anti-interference ability to 50Hz power frequency signal in strong electric field, also narrowed the blind area. In instrumental function, adopts scoustoelectric synchro-receive and display technology, to get rid of the disturbing of the local noise effectively. Especially, the digital display of the fault distance exempt the operating from the analyzing to a complicated waveform, replacing the function of sketch testing of stroke flash device in a certain extent. For a cable in several hundreds length, you can locate the fault spot fast and precisely with a sketch test. Adopting 15z amplitude modulation electro-magnetic waves and amplitude detective technology test the cable path and the buried depth, avoiding the interference of TV set line frequency.

4) Easy to operate, you just need to turn on/off the power to test and don't have to change channel or select function. Meanwhile, this powerful device is compose of modules and have compact structure and small in size, be convenient for carry.

3 Panel sketch map

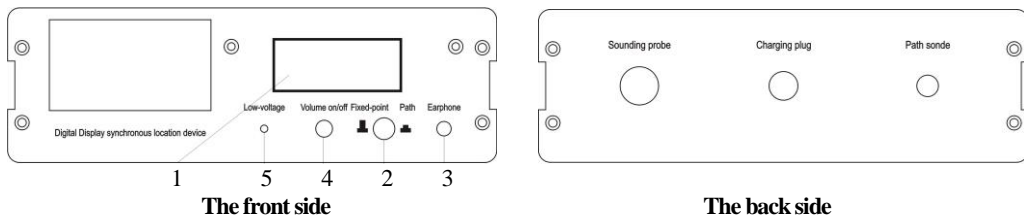

1. Distance display screen
2. location/path
3. Earphone socket
4. Volume button
5. Under-voltage

4 Main parameters:

- 1) Digital display distance: Max. 500m, Min. 0.1m
- 2) The sketch test error is less than 10%, location error is zero.
- 3) Electromagnetic channel gain is more than 110dB (300,000 times).
- 4) The sensitivity of electromagnetic channel receiver is less than $<5\mu\text{V}$.
- 5) Sounding channel audio amplifier gain is less than 120dB (When the ratio of

signal-to-noise is 4:1, the audio signal will be amplified 1 million times.)

6) 50Hz power frequency restrain degree is more than 40dB (100 times).

7) Scoustoelectric synchro-display and monitor: In actual location operation, digital screen will count repeatedly under the influence of the electromagnetic wave and show the distance of the fault, the maximum distance reading is 500m. Meanwhile, the hi-resistance earphone will monitor the seismic wave produced by the spark arising from the fault-spot been punctured to get rid of the interference of the clutter wave.

8) If you change the sound wave probe to 15KHz electric sensing probe, this device can also be used for testing the cable path and the buried depth precisely.

9) Power source: 6V free from maintenance battery of 1.2AH.

10) Power loss: <120mA (0.7W)

11) Operational environment: humidity 80% , temperature -10°C—50°C

5 Introduction of the operation theory:

This device is composed of hertzian waves transducer, sound wave vibration sensor, data processor, LED distance display and audio frequency amplifier. Please see the schematic diagram is Pic 2.

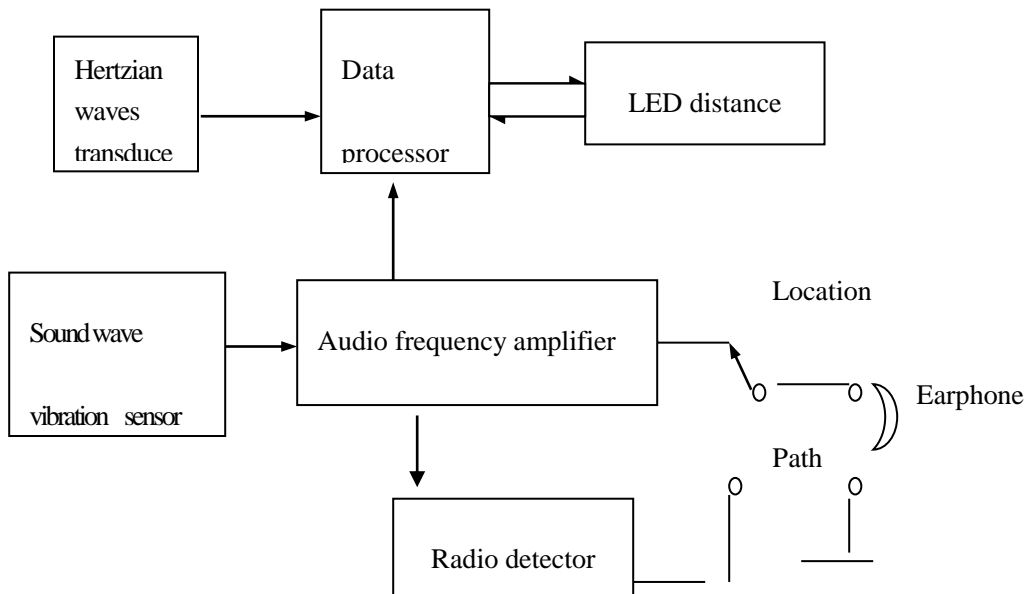

Pic 2 schematic diagram

When locate the fault spot by a impact hi-voltage discharge method, the hertzian waves transducer receive the Hertzian waves transmitted by the cable impulse firstly, then sending it to data processor. This signal will be amplified at the dame time. Then the distance conversion procedure will work out the distance. When the sound wave vibration sensor receives the

seismic signal, it also send this signal to data processor for amplifying and producing a counting interrupt signal. The distance display will show the final result(the distance of the fault spot) and fix the data for stably analysis. The data will be refreshed in the second discharge process. Because that the transmission speed of the Hertzian waves is far outpace the earth surface sound wave, the data processor can calculate the distance of the fault spot by the formula of $I=TV$..

In the formula, I(m) is the distance, V(m/s) is the transmission speed of the sound wave in the earth or cable. T(s) is the time difference of two different waves.

Audio frequency amplifier can amplify the weak seismic wave signal collected by sound wave vibration sensor and monitored by earphone. Combined with the data display in the screen, you can locate the fault spot precisely.

If the seismic wave is too weak to produce a counting interrupt signal, the distance display will send the interrupt signal automatically and the maximum distance reading is 500m.

6 Operate method:

1) Locate the fault precisely: When impulse hi-voltage generator impact the fault cable in a hi-voltage(this voltage must be sufficient high to make sure that the fault spot is punctured completely to discharge), put the audio vibration sensor above the cable path, then switch on and set the location device in “location” channel. On one hand, monitor the seismic wave by earphones, on the other hand, you can also observe the strength of the magnetic signal by magnetic-meter. Before you catch the seismic wave(may be you are far away from the fault spot), the reading of the distance display will refresh the data continuously along with the discharge and the maximum distance reading is 500m. Move the sensor probe along the cable steadily until you hear the seismic wave sounding of the fault spot(that means you have approached the fault spot). When the sound is strongly enough, the distance display will show the actual distance of the fault spot. Then you should put the sensor probe in the corresponding position, the move the probe back and forth to seek the position is where the minimum reading is display. This position is exactly the fault spot. Meanwhile, this reading is also the approximately the depth of the buried cable(The sound in the earphone is the loudest at this time and in synchronization with the refresh reading).

2) Seeking cable path: To seek the path of a cable, firstly you should exert a 16KHz amplitude modulated source on the beginning end of the cable to be tested. Then insert a 16KHz sonde vertically in the input port in the back of the device, set the device in “path” channel and monitor the 16KHz interrupted wave by an earphone and observe the strength of the magnetic signal by magnetic-meter. When the sonde is directly above the cable, the sound is lowest and the swing of the amplitude is the smallest. Blow the sonde is exactly the buried cable. When the

sonde is deviated the path of the cable, the sound is loudest and the swing of the amplitude is the biggest. The line of the lowest sound spot is precisely the path of the buried cable.

3) Test the depth of the buried cable: After you have tested the path of a cable, cling the head of the sonde vertically and tightly to the lowest sounding spot, then slant the cable to a 45 grade(the sound is bigger gradually), then move the sonde along the path vertically and parallel. Meantime, monitor the sound by earphone. After you received the lowest sound again, the moving distance of the sonde is exactly the buried depth of the cable.

7 Notice:

- 1) If conditions permits, firstly you should perform a sketch testing about the fault distance by stroke flash device, then located the buried path of the cable precisely. This device is used for final location. Do not locate the fault if the path is uncertain.
- 2) If you don't have a stroke flash device, you should seek the path of the cable firstly, then locate the fault spot precisely.
- 3) The sonde and the host of the device is precision tool, a falling or collision is definitely prohibited.
- 4) Do not disassemble the sonde or device to prevent from a damage cause by human error.

8 Eight, simple maintenance and repair:

1) . Turn on the tester and set the statue to LOCATION, digital display normally work, adjust the volume to maximum, the headset is a slight noise, but if you knock on sound probe, the headset without any reaction. The possible failure includes:

A : Output cable plug of probe is not inserted in place;

B: Unsoldering or breaking of the plug cable cores;

C Probe cable break;

2) . Turn on the tester and set the statue to LOCATION, the probe sensitivity is significantly low, when knock on the probe, headphones loud very weak. The Possible failure includes:

Due to rough handling in transit, the probe was damaged, then you should carefully unscrew the probe on the end caps, soldering the sensor chips by yourself, then fix it in the probe.

3) . You must recharge the battery after several hours work once the digital display and the voice from headset is weak. Generally, the device can work for 10 hours if it is fully charged.

Chapter VII introduction of cable route test

Application

Detect the route and depth of cable.

1 Feature

Adopts amplitude modulation 15KHz sinusoidal signal, good performance in resisting co-channel interference (15635Hz). Not only suitable for heterodyne receiver, but also can be used for Vertical Multi-Voltage demodulation receiver.

The output signal of this test can reach to 10Km away for detection.

2 Technical parameter

- 1) Output power: Greater than 30w at 10Ω load resistance.
- 2) Frequency of operation: 15KHz
- 3) Operation Mode: interrupted(1Hz/s interval), constant amplitude output, amplitude modulated (modulation frequency 400—1000Hz). Constant out is for heterodyne receiver, modulated amplitude is for Vertical Multi-Voltage demodulation receiver.
- 4) Automatic overheating and overload self-protection, can run over 8 hours continuously.
- 5) Power source: AC 220V ±10%
- 6) Environment: Temperature -20 — +50 °C , humidity below 95%

3 route signal generator panel

- 1) Indication display: indicate the value of output power.
- 2) Q9 plug: output terminal of route test, connecting cable core.
- 3) amplitude modulation knob: modulating test to match impedance of cable to maximize the power output.
- 4) power source: AC 220V
- 5) Power switch: light is on means the test is work normally.
- 6) Accessory: a cable used for connecting signal output. Red alligator clip connect cable

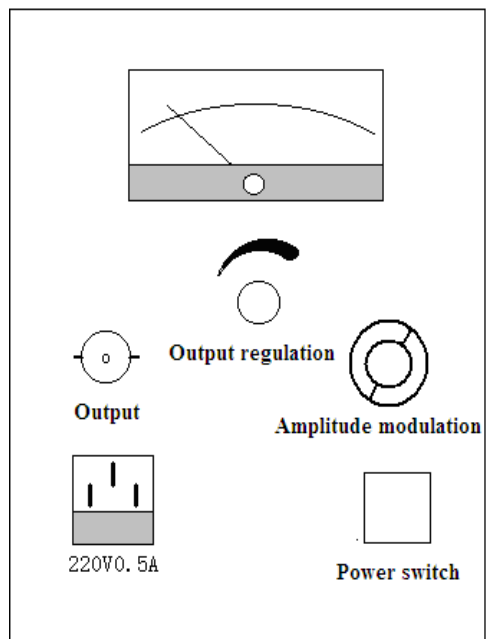

armor(ground wire should disconnected), black alligator clip connect ground wire of the system. Q9 plug insert into the Q9 output socket in the panel.

See the connecting diagram

Shown the connecting diagram in Figure 7.

4 Detect the depth of the cable:

After you know the route of the cable, please make the probe head vertical close to the minimum point of the sound on the ground, then let the probe along the cable path to tilt 45 degrees (at this time sounds in the headphone become louder), and then move the probe parallel to the vertical direction along the cable path sound, while listening with headphones, when the smallest sound is heard again, the distance traveled by the probe on the ground is the cable burial depth.

Chapter VIII Introduction for the fundamental of path-seeking device

1 Introduction for the fundamental of path-seeking device

Path-seeking fundamental is as follow: Exert a electromagnetic wave signal to the cable to be tested, receive the path signal by the electromagnetic collection channel of location device. Exactly above the cable, the electromagnetic signal is weakest. According to this theory, you can seek the path of the cable precisely.

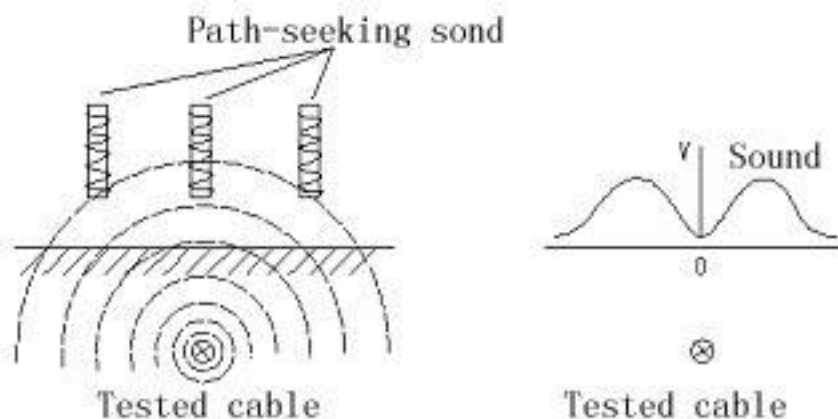

2 Operation method:

1) Connect the core of the cable to be tested and the ground wire with the link cables. The other

sides of the cables are connected to the wire holder 5 correspondingly.

2) Connect the power correctly, adjust the impedance matching switch and set the power button in correct volume. Adjust the output-diversion button to the break-off channel then turn on the device.

3) Set the device in "path" channel, insert path-seeking sonde, the sonde should be vertically to the ground. Swing the sonde left and right along the cable and monitor the sound to seek the minimum sound spot. By this method, you can seek the path of the cable easily.

Note: By this method, the path-seeking device must be set in path function(Press down location/path button). You can also judge the buried path of a cable by observe the Φ value of the magnetic channel without monitor. Namely that when is reading of the meter-head indication is the smallest or even is zero, it means that the sonde is exactly above the buried cable (Receiving antenna must be vertical to the ground) .