

Keysight Technologies B1506A Power Device Analyzer for Circuit Design

Operation and
Demonstration
Guide

Notices

© Keysight Technologies 2015, 2016

No part of this manual may be reproduced in any form or by any means (including electronic storage and retrieval or translation into a foreign language) without prior agreement and written consent from Keysight Technologies as governed by United States and international copyright laws.

Manual Part Number

B1506-90500

Edition

Edition 1, February 2015

Edition 2, August 2016

Published by:

Keysight Technologies International Japan
G.K.

9-1, Takakura-cho, Hachioji-shi, Tokyo
192-0033 Japan

Warranty

The material contained in this document is provided “as is,” and is subject to being changed, without notice, in future editions. Further, to the maximum extent permitted by applicable law, Keysight disclaims all warranties, either express or implied, with regard to this manual and any information contained herein, including but not limited to the implied warranties of merchantability and fitness for a particular purpose. Keysight shall not be liable for errors or for incidental or consequential damages in connection with the furnishing, use, or performance of this document or of any information contained herein. Should Keysight and the user have a separate written agreement with warranty terms covering the material in this document that conflict with these terms, the warranty terms in the separate agreement shall control.

Technology Licenses

The hardware and/or software described in this document are furnished under a license and may be used or copied only in accordance with the terms of such license.

Restricted Rights Legend

If software is for use in the performance of a U.S. Government prime contract or subcontract, Software is delivered and licensed as “Commercial computer software” as defined

in DFAR 252.227-7014 (June 1995), or as a “commercial item” as defined in FAR 2.101(a) or as “Restricted computer software” as defined in FAR 52.227-19 (June 1987) or any equivalent agency regulation or contract clause. Use, duplication or disclosure of Software is subject to Keysight Technologies’ standard commercial license terms, and non-DOD Departments and Agencies of the U.S. Government will receive no greater than Restricted Rights as defined in FAR 52.227-19(c)(1-2) (June 1987). U.S. Government users will receive no greater than Limited Rights as defined in FAR 52.227-14 (June 1987) or DFAR 252.227-7015 (b)(2) (November 1995), as applicable in any technical data.

WARNING



High Voltage

is used in the operation of this equipment.

LETHAL VOLTAGE on CONTACT

may be present at measurement terminals,
if you fail to take in all safety precautions!

- When the RED indicator lights, lethal voltage (± 10 kV dc/pulse) may appear at measurement terminals.
- **Usually use the interlock function**
- Do not operate the instrument unless another person is around the work space that is familiar with instrument operation and hazards or administering first aid.
- Potentials less than ± 500 V may cause death under certain conditions. Therefore, adequate preventive measures must be taken at all times!

FIRST AID FOR ELECTRIC SHOCK

SPECIAL ATTENTION TO RESCUE IN SAFETY

- Never rush into an accidental situation.
- Take special attention to the following notices to prevent second accident.
 - ✓ Do NOT touch the CASUALTY or conductive surface with your hands unprotected.
 - ✓ Shut off high voltage at once.
 - ✓ Disconnect AC mains.
- If it is unsure to make safe, the following procedure will help to protect your lives during the CASUALTY is rescued.
 - ✓ Stand on a dry insulating material; use a dry wooden or plastic implement to free the CASUALTY from contact with hazardous electrical source.
 - ✓ Ground the circuit to de-energize.

Contents

1.	Getting Started	7
	Introduction	8
	Operational Procedure	8
	Preparation	10
	B1506A Hardware Configuration	10
	Easy Test Navigator Software	13
	Calibration	17
2.	Datasheet Characterization	19
	Overview	23
	Datasheet characterization mode.....	23
	Measurement parameters of devices.....	26
	Basic functions.....	32
	Datasheet characterization GUI.....	32
	Basic Functions	33
	An IGBT measurement example	37
	Devices and test fixtures	37
	Measurement Steps	40
	Step 1 Starting the datasheet characterization mode.....	40
	Step 2 Creating a new datasheet definition.....	41
	Step 3 Input the device information.....	42
	Step 4 Input the maximum ratings.....	44
	Step 5 Creating a setup for the characteristics parameters section	46
	Step 6 Creating a setup for characteristics graphs section.....	89
	Step 7 Updating the entire setup	119
	Step 8 Run a test of the entire parameters and graphs	120
	Step 9 Reviewing and checking the printing image of the measurement result .	130
	Step 10 Printing the datasheet	133
	Step 11 Creating a summary report from multiple test result files.....	136
	Useful information for using the datasheet characterization mode	139
	Tips to customize a datasheet setup	139
	The UHCU details and measurement tips	158
	How to change the connections of Rg measurement	164
	Capacitance Measurement Tips.....	167
	Measurement theory and detail explanation of the measurement capability	168
	Capacitance measurement techniques	168
	Gate charge measurement basics	171

	How to use the Oscilloscope View function	174
3.	I/V Measurement	179
	Overview	180
	Measurement parameters of device types.....	181
	Demonstration examples	183
	How to open the I/V measurement mode.....	184
	IV measurement examples	185
	1. IC-VCE IGBT characteristics	185
	2. ID-VDS power MOSFET characteristics	192
	3. ID-VGS power MOSFET characteristics	196
	4. Vgs(th) power-MOSFET characteristics.....	198
	5. RDS-ID power MOSFET characteristics	200
	6. VDS-VGS, RDS-VGS power MOSFET characteristics.....	202
	7. IDSS power MOSFET characteristics.....	206
	8. IGSS power MOSFET Characteristics	210
	9. IS-VSS power MOSFET Characteristics.....	212
	10. IGBT module measurement	215
	Useful information for using I/V measurement mode.....	219
	The differences between the quick mode and the fine mode	219
	How to avoid device oscillation	222
	Accurate measurement using a narrow pulse	223
4.	Capacitance Measurement.....	227
	Overview	228
	Measurement parameters of each device type	231
	Measurement frequency consideration	233
	How to open the capacitance measurement mode.....	238
	Capacitance measurement mode examples.....	239
	1. Ciss, Coss, Crss MOSFET characteristics	240
	2. Rg internal gate resistance characteristics of Power MOSFET	243
	3. IGBT module measurement example and tips.....	246
	Useful information for using capacitance measurement mode.....	248
	Crss measurement of super junction FET	248
	Capacitance compensation data measurement.....	251
	Rg measurement with the open or voltage biased drain/collector	255
	Vgs accuracy improvement by self calibration	259
5.	Gate Charge Measurement	261
	Overview	262

Measurement preparation	264
How to open the gate charge measurement mode.....	264
Gate charge measurement adapter	264
Gate charge measurement examples.....	267
1. Qg Measurement Using Constant Current Load	267
2. Qg measurement using a resistive load.....	283
Useful information for using Qg measurement mode.....	292
Calibration for gate charge measurement.....	292
Brief idea of the gate charge measurement setup	300

1. Getting Started

Introduction	8
Operational Procedure	8
Device data:.....	8
Preparation	10
B1506A Hardware Configuration	10
Mainframe and test modules	10
Cable connections.....	10
Test fixtures	12
Easy Test Navigator Software	13
Easy Test Navigator software.....	13
Starting the Easy Test Navigator software	14
Quitting from the Easy Test Navigator software.....	15
How to start each measurement mode and return to the Pallet window	15
Saving and recalling your setup and measurement data.....	16
Exiting from your setup	16
Calibration	17

Introduction

This documentation provides step by step operations of the basic functions of the Easy Test Navigator software of the B1506A Power Device Analyzer for Circuit Design, so that the B1506A user can start a basic measurement from the first use of the B1506A.

Operational Procedure

The step by step operational procedure describes to create a setup of datasheet characterization function of the B1506A under a demo style which is to set up the B1506A and make measurements using the following demo devices.

The following test devices are used in the example:

- IGBT: FGA180N33ATD
- MOSFET: IXTH1N250
- LDMOSFET: IRFP4004
- MOSFET: IXTX200N10L2N (For current load)
- Super Junction MOSFET: IPW50R109CE (Reference only)
- SiC MOSFET: CMF20120D (Reference only)
- IGBT Module: 1MB1800U4B (Reference only)

Devices used in the example demonstration.



FGA180N33ATD
IGBT



IXTH1N250
HVMOS



IRFP4004
HCMOS

Device data:

Following lists the simplified device data used in the measurement examples.

IGBT: FGA180N33ATD

- VCES: 330 V
- VCE(sat): Typ. 1.68 V @ Ic=180 A
- ID max.: 450A @ 100 μ s pulse, VC=16 V
- SOA: 7.5 kW @ Tc=25 $^{\circ}$ C, 100 μ s pulse
- Vth: 2.5~5.5 V (typ.=4 V) @ Ic=250 μ A
- Coss: 305 pF typ. @ Vc=30 V

MOSFET: IRFP4004Pbf

- VDSS: 40 V
- Rds(on): Typ. 1.35 m Ω (1.70 m Ω max.) @ Vgs=10 V)
- ID max.:350A @ 100 μ s pulse, VD=10V
1390 A @ Vd=2.5 V
- SOA: 3.5 kW @ Tc=25 $^{\circ}$ C, 100 μ s pulse
- Vth: 2~4 V @ Id=250 μ A
- Coss: 2360 pF typ. @ Vd=25 V

High Voltage MOSFET: IXTH1N250

- VDSS: 2500 V
- Rds(on): Max. 40 Ω
- ID max.: 6 A @ 100 μ s pulse, 5 kW @ Tc=25 $^{\circ}$ C
- SOA: 3 kW @ Tc=25 degC, 100 μ s pulse
- Vth: 2~4 V @ Id=250 μ A
- Coss: 77 pF typ. @ Vd=25 V

MOSFET: IXTX200N10L2

- VDSS: 100 V
- ID max.: 500 A @ 100 μ s pulse, VD=35 V
- SOA: 17.5 kW @ Tc=25 $^{\circ}$ C, 100 μ s pulse
- Rds(on): 11 m Ω

Preparation

This section provides the basic information for preparing the demonstration.

B1506A Hardware Configuration

Mainframe and test modules

This guide uses the B1506A with following configuration.
Figure 1-1 shows the module configuration of the mainframe of the B1506A-H51 and H71. It includes the following measurement modules.

- Slot 1: MPSMU
- Slot 2: MFCMU
- Slot 3: MCSMU
- Slot 4: MCSMU
- Slot 5: MCSMU
- Slot 6: MCSMU
- Slot 7: HVSMU

Figure 1-1. Module configuration of B1506A H-51 and H71.



Cable connections

The B1506A uses the following three kinds of cable sets to make the connection between the B1506A mainframe and the B1506A-H51 and H71 test fixture as shown in Figure 1-2.

- Digital I/O cable
- N1300A CMU cable
- System cables (2x5 SMUs cables, 1x HVSMU cable, 1x GNDU cable, 1x Interlock cable)

Figure 1-2 Cable connection of B1506A H51 and H71.

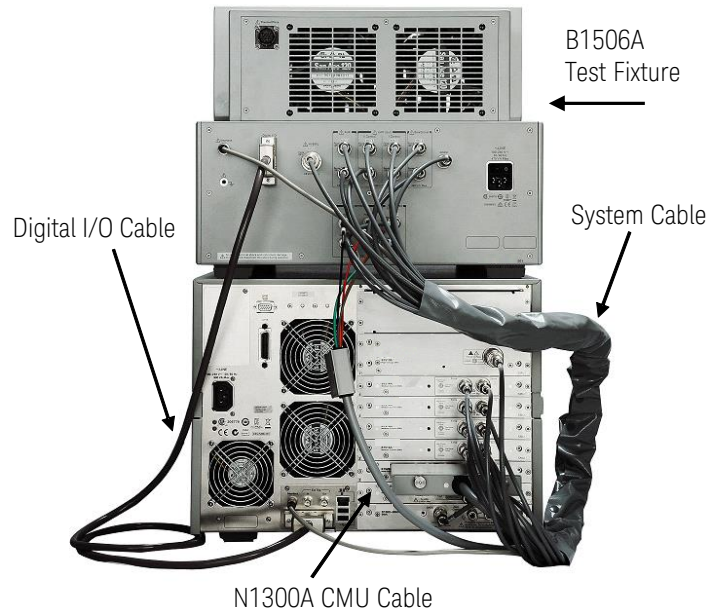

Each cable in the system cable is labeled to indicate the terminal to be connected. (Refer to Figure 1-2 and Figure 1-3.)

For example, the cable labeled 1F is connected to the force terminal of the SMU1, and 1S is connected to the sense terminal of the SMU1 respectively.

Figure 1-3 Input port of the test fixture of B1506A-H51 and H71.

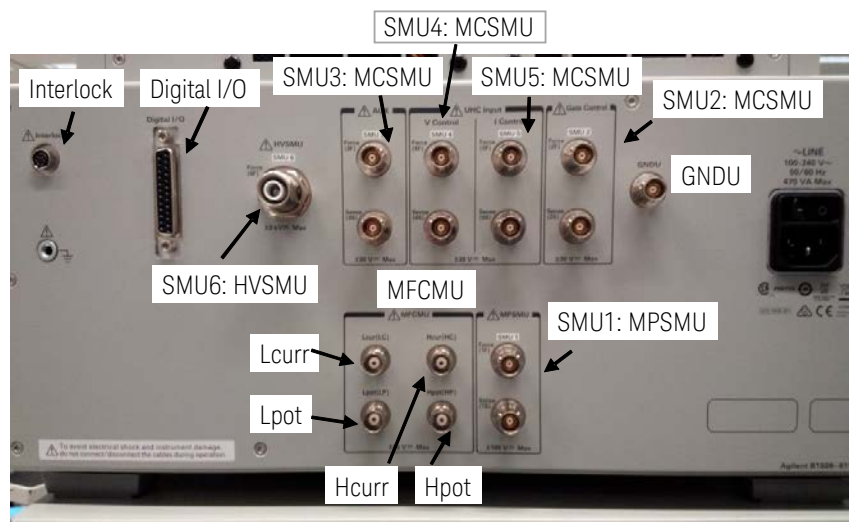

Note

In the case of the B1506A-H21, which is not configured as shown in Figure 1-2, connect the cables by referring to the installation section of the B1506A user's guide.

Test fixtures

The following two types of test fixtures are used.

- 3-pin Inline Package Socket Module
- Gate Charge Socket Adapter

Figure 1-4

Opt.F10 3-pin Inline Package Socket Module.



Figure 1-5

Opt.F14 Gate Charge Socket Adapter.



Easy Test Navigator Software

Easy Test Navigator software

Easy Test Navigator as shown in Figure 1-6 is resident software of the B1506A and its startup screen is a launcher to switch to one of the following measurement modes:

- Datasheet Characterization
- IV Measurement
- Capacitance Measurement
- Gate charge measurement

It also switches to the following software.

- Power Loss Calculation software
- Temperature Monitor/Control mode setup.

Figure 1-6

Easy Test Navigator software.

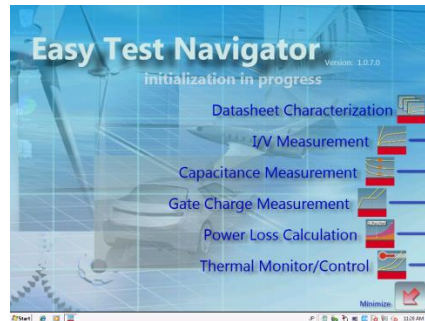

This quick start guide provides the information of how to use this software and make measurements.

Starting the Easy Test Navigator software

Before starting Easy Test Navigator, confirm the power of the B1506A test fixture is on.

To start Easy Test Navigator, select “Easy Test Navigator” under the “Keysight Easy Test Navigator” in the start menu of MS Windows (Figure 1-7 (a)).

Easy Test Navigator start up panel appears (Figure 1-7 (b)), and it moves to home panel (Figure 1-7 (c)) called Pallet of Easy Test Navigator. At the startup of Easy Test Navigator, the B1506A is initialized. During the initialization of the B1506A, the label of “initialization in progress” is blinking, and the selection bar of each measurement mode is disabled.

Figure 1-7

Select Easy Test Navigator from Start menu.



(a) Select "Easy Test Navigator"

(b) Easy Test Navigator start up panel

(c) Easy Test Navigator home panel

During the initialization process, the LEDs on the front panel of the B1506A test fixture change from orange color to green as shown in Figure 1-8 when the initialization is completed successfully. If the initialization fails, the LED of power stays in orange.

Figure 1-8

LED indicator changes to green after the initialization.

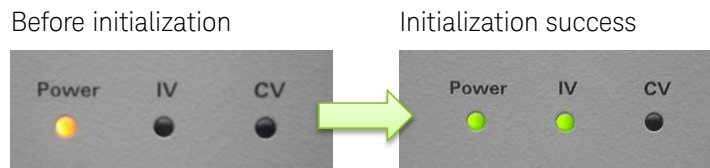

Quitting from the Easy Test Navigator software

There are two ways to quit Easy Test Navigator.

One is to move the mouse cursor to the top right of the pallet panel and click the cross mark appeared when the mouse cursor is there (Figure 1-9 (a)).

The other way is to right click the Easy Test Navigator icon in the task bar and select "Close window" from the list as shown in Figure 1-9 (b).

Figure 1-9 Two ways to quit East Test Navigator.

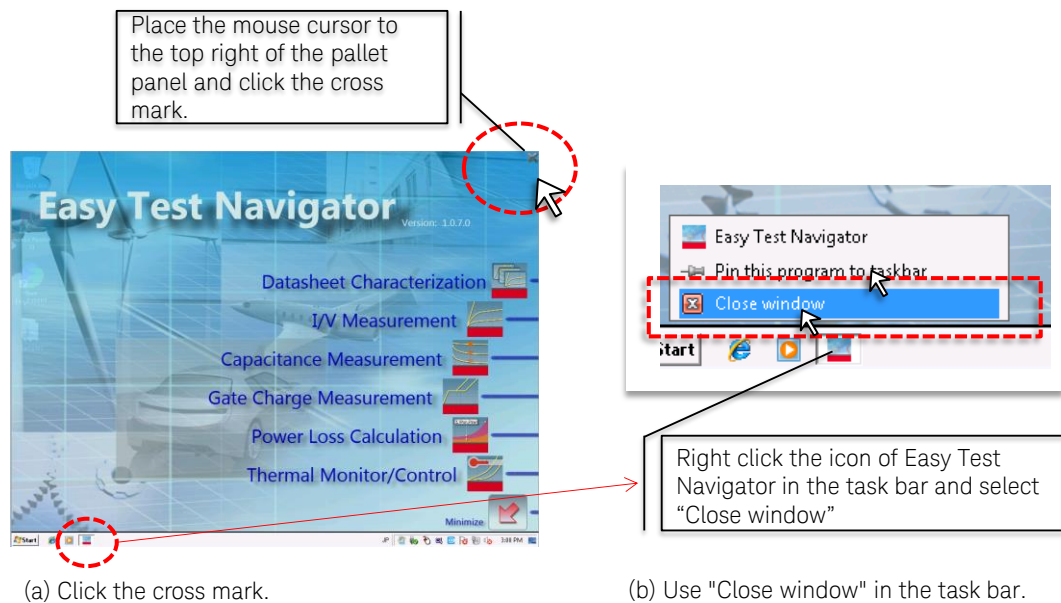

Note: The Figure 1-9 (b) approach is effective to quit each measurement mode.

How to start each measurement mode and return to the Pallet window

How to start each measurement mode:

To launch each measurement mode, place the mouse cursor to the label of the targeted measurement mode and click it.

How to return to the Pallet window:

To go back to the pallet window from the individual measurement mode, click the "Go to Pallet" Icon in the top of the window as shown in Figure 1-10 (a).

Figure 1-10

Pallet icon of each measurement mode is used to returns to the Pallet panel of Easy Test Navigator.

(b) Recall and Save (a) Returns to the Pallet panel

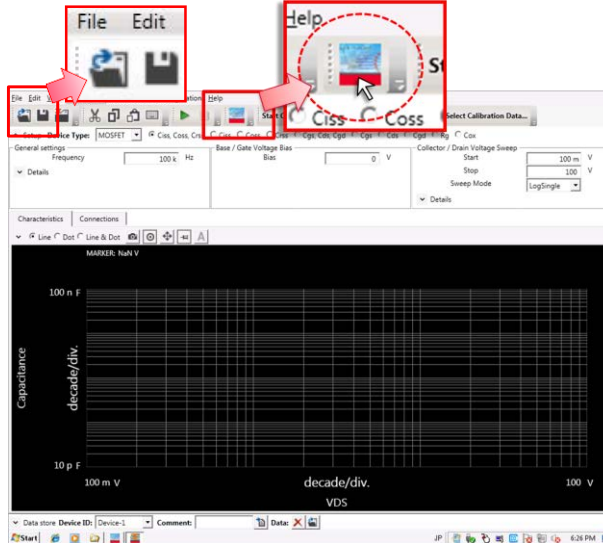

Saving and recalling your setup and measurement data

You can save and recall your measurement setups and the measurement data to the Windows file system in your specified folder and the file name as shown in Figure 1-10 (b).

Exiting from your setup

You can exit from the setup window by clicking the "Exit" icon in the menu bar, or from the file menu as shown in Figure 1-11.

Note:

All the non-saved data in the existing window or panel is not saved when you exit from your setup.

Note that, "Go to Pallet" keeps the setup until you exit from the setup panel or window.

Figure 1-11 Exiting from the Setup panel.

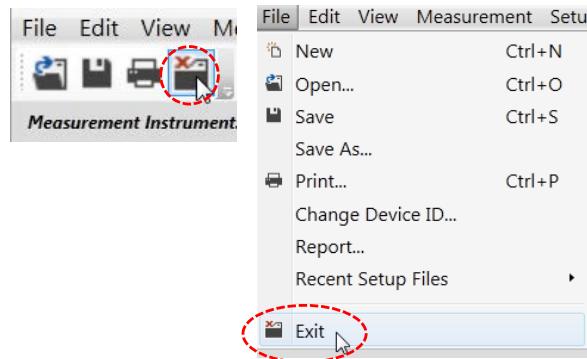

Calibration

There are calibration functions in the capacitance measurement mode and the gate charge measurement mode. These calibrations improve the measurement accuracy, but they are not performed in the operational demo course because they are not necessary for demoing purpose of the Easy Test Navigator functions.

These calibration procedures are included in the following calibration section of each of these test modules.

Capacitance calibration:

Refer to "**Capacitance Compensation Data Measurement**" in Chapter 4.

Gate charge calibration:

Refer to "**Calibration for Gate Charge Measurement**" in Chapter 5.

Getting Started

2. Datasheet Characterization

Overview	23
Datasheet characterization mode.....	23
Measurement parameters of devices.....	26
Basic functions.....	32
Datasheet characterization GUI.....	32
Basic Functions	33
Steps to measure datasheet characteristics of power device.....	34
An IGBT measurement example	37
Devices and test fixtures	37
Device used in the example	37
IV and CV test socket module.....	37
Gate charge test socket adapter	38
Measurement Steps	40
Step 1 Starting the datasheet characterization mode.....	40
Step 2 Creating a new datasheet definition.....	41
Step 3 Input the device information.....	42
Step 4 Input the maximum ratings.....	44
Step 5 Creating a setup for the characteristics parameters section	46
5.1 BVCES	46
How to set up BVCES test condition parameters	46
How to set up the detailed I/V measurement parameters.....	47
Verification of the BVCES measurement setup	50
5.2 ICES.....	52
To set up ICES test conditions and I/V measurement parameters.....	52
Verification of the ICES measurement setup.....	53
5.3 IGES.....	54
How to set up IGES measurement parameters	54
Verification of the IGES measurement setup.....	56
5.4 VGE(th)	57
How to set up VGE(th) measurement parameters	57
Verification of the VGE(th) measurement setup	59
5.5 VGE(th) with constant VCE	60

5.6 VCE(sat).....	64
VCE(sat) test conditions for IC=40 A	64
Verification of the VCE(sat) at IC=40 A measurement setup	67
VCE(sat) test conditions for IC=180 A	67
Verification of the VCE(sat) at IC=180 A measurement setup	69
5.6 Transconductance (gfs)	70
5.7 VF of freewheeling diode	72
How to set up VF measurement parameters.....	72
Verification of the VFM measurement setup	74
5.9 Other IV parameters.....	75
5.10 Internal gate resistance (Rg).....	75
How to set up Rg measurement parameters	76
5.11 Capacitance (Cies, Coes, Cres).....	80
How to set up capacitance measurement parameters	80
Verification of the Cies capacitance measurement setups	82
Verification of the Coes, Cres capacitance measurement setups.....	82
5.12 Gate charge (Qg, Qge, Qgc)	83
How to set up gate charge measurement parameters	83
How to choose a current load FET	84
Qg setup.....	85
Verification of the Qg measurement setup.....	87
Qge, Qgc setup	87
Ho to delete the gate plateau voltage Vge(pl)	88
Step 6 Creating a setup for characteristics graphs section.....	89
6.1 IC-VCE characteristics	90
How to set up IC-VCE graphics measurement parameters	90
Verification of the IC-VCE measurement setup.....	93
6.2 IC-VGE transfer characteristics	95
How to set up IC-VGE graphics measurement parameters.....	95
6.3 VCE-VGE characteristics - VCE(sat).....	103
How to set up VCE-VGE graphics measurement parameters	103
6.4 VF Freewheeling diode forward characteristics	111
How to set up VF graphics measurement parameters.....	111
Verification of the IF-VF measurement setup.....	112
6.5 Other IV characteristics	114
6.6 CV characteristics	114
How to set up CV graphics measurement parameters	114

Verification of the CV measurement setup	116
6.7 Vge-Qg gate characteristics	117
How to set up Qg graphics measurement parameters	117
Verification of the Qg measurement setup	118
How to set up the 2nd Qg graphics measurement	118
Verification of the 2nd Qg measurement setup	119
Step 7 Updating the entire setup	119
Step 8 Run a test of the entire parameters and graphs	120
Step 9 Reviewing and checking the printing image of the measurement result .	130
Step 10 Printing the datasheet	133
Step 11 Creating a summary report from multiple test result files	136
Useful information for using the datasheet characterization mode	139
Tips to customize a datasheet setup	139
Tips: How to change the picture of the device	139
Tips: How to change the symbol name and the description	139
Tips: How to add a new item to the maximum ratings	140
Tips: How to add the minimum / maximum limit to the characteristics parameters	140
Tips: How to change the association of the test conditions with the measurement setup	141
Tips: How to delete the items	144
Tips: How to restore the deleted items	144
Tips: How to duplicate the existing setup	145
Tips: How to change locked parameter in the setup	145
Tips: How to create a new item by modifying the existing item	146
Tips: How to create a new item from the measurement setup	150
Tips: How to import the data from the other measurement setup	155
Tips: How to merge the data of different datasheet setups	156
Tips: How to change the connection diagram	156
Tips: How to change the order of the measurement	156
Tips: How to skip the specified item	156
Tips: How to measure IV, CV and Qg at the specified temperature using the Thermal Monitor/Control function	157
Tips: How to stop the measurement when the result exceeds the limits .	157
The UHCU details and measurement tips	158
How to set the UHCU's V/I parameters for the VCE(sat)	158
How to set the voltage force mode setup	160

The IC-VGE output characteristics measurement using the UHCU	161
How to change the connections of Rg measurement	164
Connection of collector/drain open condition	164
Connection of the collector/drain and the emitter/source shorted.....	165
Connection of collector/drain and emitter/source shorted	165
Capacitance Measurement Tips.....	167
Tips: How to measure large capacitance	167
Tips: How to enhance measurement accuracy	167
Tips: Capacitance data dependency when lowering the measurement frequency	167
Measurement theory and detail explanation of the measurement capability	168
Capacitance measurement techniques	168
Gate charge measurement basics	171
SOA and current load FET in Qg test.....	172
How to determine Ig to measure gate charge.....	173
How to use the Oscilloscope View function	174

Overview

The datasheet characterization function of the B1506A automatically measures a series of electric parameters described in the device datasheet. It includes static electric parameters, capacitance parameters, gate charge (Qg) parameters, and characteristic graphs of these parameters.

Datasheet characterization mode

The image of this function is shown in Figure 2-1, where the device datasheet shown in the left as Figure 2-1 (a) can be measured and printed as shown in Figure 2-1 (b) on the right side.

Figure 2-1 Operational image of the datasheet characterization mode.

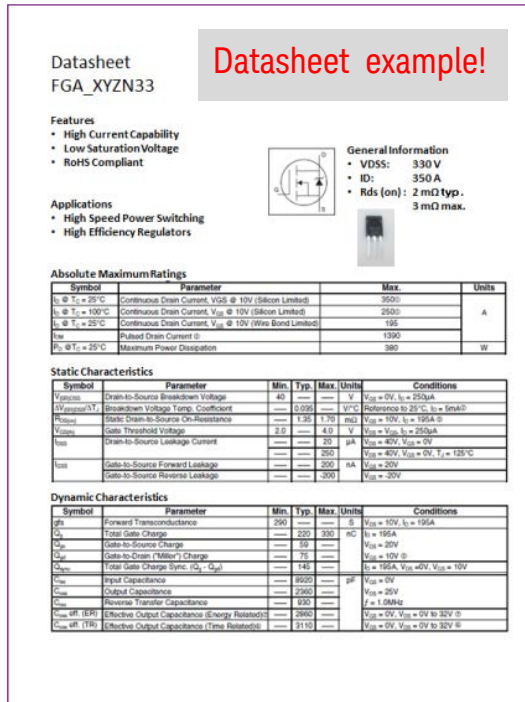

(a) Device datasheet image

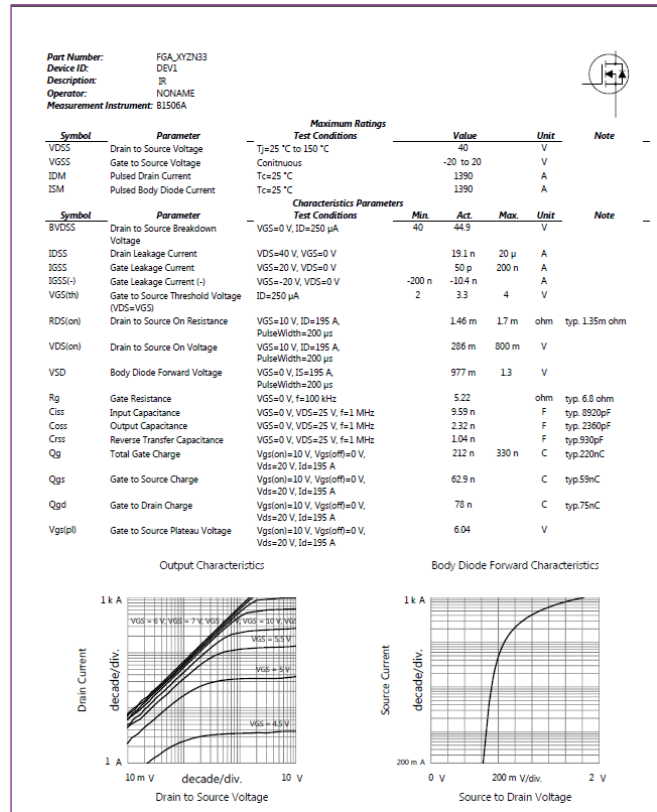

(b) Datasheet Characterization output image

A function to create a summary report from the multiple datasheet files is available in the datasheet characterization mode.

Figure 2-2 shows an example of the summary report imported into a spreadsheet application (the summary report is created in tab separated variable format).

Figure 2-2 A summary report imported into the spreadsheet application

DeviceID	PartNum	SampleID	BVCS	ICES	IGES	IGES(-)	VGE(th)	VCE(sat)	VCE(sat)_VFM	Cies	Coes	Cres	Qg	Qge	Qgc	File
Device-1	FGA180N3	Sample1	371.4	8.80E-08	5.00E-11	0	3.882	1.0409	1.7031	1.1342	4.07E-09	3.13E-10	1.76E-10	1.75E-07	2.30E-08	7.15E-08 C:\Users\Public\Document
Device-1	FGA180N3	Sample2	363.003	9.50E-08	5.00E-11	5.00E-11	3.894	1.0444	1.7113	1.1309	4.03E-09	3.15E-10	1.76E-10	1.70E-07	2.27E-08	6.98E-08 C:\Users\Public\Document
Device-1	FGA180N3	Sample3	367.992	9.80E-08	5.00E-11	0	3.947	1.0385	1.6978	1.1335	4.03E-09	3.19E-10	1.76E-10	1.70E-07	2.28E-08	6.94E-08 C:\Users\Public\Document
Device-1	FGA180N3	Sample4	372.894	9.00E-08	5.00E-11	0	3.872	1.0428	1.7158	1.1369	4.08E-09	3.11E-10	1.77E-10	1.78E-07	2.32E-08	7.33E-08 C:\Users\Public\Document
Device-1	FGA180N3	Sample5	372.756	9.40E-08	5.00E-11	0	3.835	1.0422	1.7123	1.1342	4.08E-09	3.11E-10	1.77E-10	1.78E-07	2.32E-08	7.33E-08 C:\Users\Public\Document

Steps to create a setup of the datasheet characterization mode are described from the next section headed “Basic”.

Note: Supported Device types

Initially, Datasheet Characterization mode covers the following five types of device:

- Power MOS-FET
- IGBT
- BJT
- Diode
- Component

Note: Software relations

The Data sheet Characterization measures the following three parameter groups as DC, capacitance and gate charge. These parameters are measured using three measurement modes as the measurement engine as shown in Figure 2-3.

Because the Datasheet Characterization function uses these measurement modes, a part of these measurement modes is explained in this chapter, too.

Figure 2-3

Measurement mode used in the Datasheet Characterization

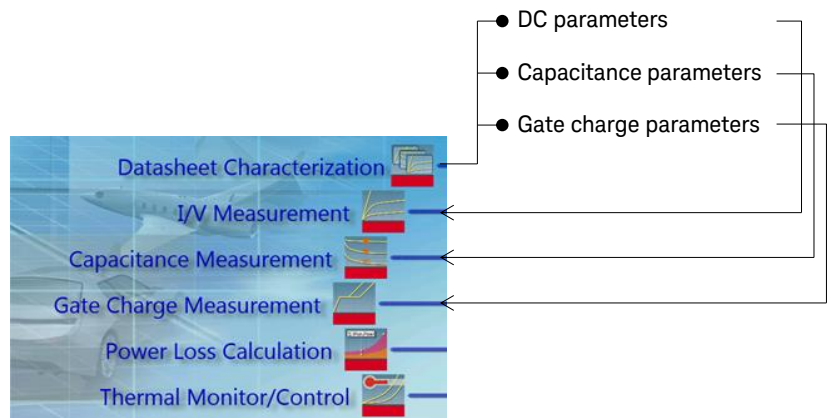

Measurement parameters of devices

The datasheet characterization mode supports the following parameters in five types of device type.

MOSFET parameters

MOSFET device type supports the following device parameters and device characteristics chart.

Table 2-1 Measurable parameters and chart for MOSFET

Parameters	Description
BVDSS	Drain to Source Breakdown Voltage
IDSS	Drain Leakage Current
IGSS(+)	Gate Leakage Current (Positive gate bias)
IGSS(-)	Gate Leakage Current (Negative gate bias)
VGS(th)	Gate Threshold Voltage (VGS = VDS)
VGS(th)	Gate Threshold Voltage (Constant VDS)
gfs*	Transconductance
RDS(on)	Drain to Source On Resistance
VDS(on)	Drain to Source On Voltage
VSD	Body Diode Forward Voltage
Rg	Internal Gate Resistance
Ciss	Input Capacitance
Coss	Output Capacitance
Crss	Reverse Transfer Characteristics
Qg	Total Gate Charge
Qgs	Gate to Source Charge
Qgd	Gate to Drain Charge
Vgs(pl)	Gate to Source Plateau Voltage

Graph	Description
ID-VDS	ID-VDS curve with various VGS
ID-VGS	ID-VGS curve with constant VDS
Gfs-VGS*	Gfs-VGS curve with constant VDS
RDS(on)-ID	RDS(on)-ID curve with various VGS
RDS(on)-VGS	RDS(on)-VGS curve with various ID
VDS-VGS	VDS-VGS curve with various ID
IS-VS	Forward current characteristics of built-in diode
C-V	Capacitance to VDS curve including Ciss, Coss and Crss
Qg-Vgs	Gate charge to VGS curve

*B1506A-H20/H21 only

IGBT parameters

IGBT device type supports the following device parameters and device characteristics graphs.

Table 2-2

Measurable parameters for IGBT

Parameters	Description
BVCES	Collector to Emitter Breakdown Voltage
ICES	Collector Leakage Current
IGES(+)	Gate Leakage Current (Positive Gate Bias)
IGES(-)	Gate Leakage Current (Negative Gate Bias)
VGE(th)	Gate Threshold Voltage (VGE = VCE)
VGE(th)	Gate Threshold Voltage (Constant VCE)
gfs*	Transconductance
VF	Freewheeling Diode Forward Voltage
Rg	Internal Gate Resistance
Cies	Input Capacitance
Coes	Output Capacitance
Cres	Reverse Transfer Characteristics
Qg	Total Gate Charge
Qge	Gate to Emitter Charge
Qgc	Gate to Collector Charge
Vge(pl)	Gate to Emitter Plateau Voltage

Graph	Description
IC-VCE	IC-VCE curve with various VGE
IC-VGE	IC-VGE curve with constant VCE
gfs-VGE*	Gfs-VGE curve with constant VCE
VCE-VGE	VCE(sat) Collector Saturation Voltage
IF-VF	Freewheeling Diode Forward Characteristics
VCE-VGE	VCE-VGE curve with various IC
C-V	Capacitance to VCE curve including Cies, Coes and Cres
Qg-Vge	Gate charge to VGE curve

*B1506A-H20/H21 only

BJT parameters

BJT device type supports the following device parameters and device characteristics graphs.

Table 2-3

Measurable parameters for BJT

Parameters	Description
ICEO	Collector Cutoff Current
IEBO	Emitter Cutoff Current
hft*	DC Current Gain
VCE(sat)	Collector-Emitter Saturation Voltage
VBE(sat)	Base-Emitter Saturation Voltage
VBE(on)	Base-Emitter ON Voltage
V(BR)CEO	Collector-Emitter Breakdown Voltage
V(BR)EBO	Emitter-Base Breakdown Voltage

Graph	Description
IC-VCE	IC-VCE curve with various IB
hfe-IC*	hft-I curve with constant VCE
VBE-IC*	VBE-IC curve with constant VCE

*B1506A-H20/H21 only

Diode parameters

Diode device type supports the following device parameters and device characteristics graphs.

Table 2-4

Measurable parameters for diode

Parameters	Description
VDC	DC Blocking Voltage
VF	Forward Voltage
IR	Reverse Current
C	Total Capacitance

Graph	Description
IF-VF	Forward Characteristics
IR-VR	Reverse Characteristics
C-V	Capacitance to Reverse Voltage Characteristics

Component parameters

Each device in the Component type supports the following device parameters and device characteristics graphs.

Table 2-5 Measurable parameters for component

Component type: Inductor

Parameters	Description
L	Inductance at zero bias current
RDC	DC resistance

Component type: Capacitor

Parameters	Description
C	Capacitance at zero bias voltage
C (biased)	Voltage coefficient capacitance
Leak	Leak current
R (insulation)	Insulation resistance

Graph	Description
C-V	Capacitance to Voltage Characteristics

Component type: Shunt Resistor

Parameters	Description
R	Resistance at specified current

Component type: Resistor

Parameters	Description
R	Resistance at specified voltage

Component type: Connector

Parameters	Description
R (contact)	Contact resistance
BV	Withstanding voltage
Leak	Leak current
R (insulation)	Insulation resistance
C (insulation)	Insulation capacitance

Graph	Description
R-I	Contact resistance vs. Conduction Current
C-V	Insulation Capacitance vs. Insulation Voltage

Component type: Cable

Parameters	Description
C	Capacitance
R (insulation)	Insulation resistance
R (conduction)	Conduction resistance

Graph	Description
R-I	Contact resistance vs. Conduction Current

Component type: Relay

Parameters	Description
R (contact)	Contact resistance
R (coil)	Coil resistance
R (open contacts)	Insulation resistance between open contacts
R (coil-contact)	Insulation resistance between coil and contact
V (pick-up)	Pick-up/Set voltage
V (drop-out)	Drop-out/Reset voltage
I (operating)	Operating current
C (open contacts)	Capacitance between open contacts
C (coil-contact)	Capacitance between coil and contact

Graph	Description
R-I	Conduction resistance vs. Conduction Current

Component type: Photo Coupler

Parameters	Description
V _F	LED Forward Voltage
I _R	LED Reverse Current
C _T	LED Total Capacitance
BV _{CEO}	Detector Collector-Emitter Breakdown Voltage
BV _{ECO}	Detector Emitter-Collector Breakdown Voltage
I _{CEO}	Detector Collector Dark Current
C _{ce}	Detector Collector-Emitter Capacitance
V _{CE(sat)}	Detector Collector-Emitter Saturation Voltage
C _S	Input-Output Capacitance
R _S	Isolation Resistance
B _V S	Isolation Voltage

Graph	Description
IF-VF	Forward Current vs. Forward Voltage
IFP-VFP	Pulsed Forward Current vs. Pulsed Forward Voltage
IC-VCE	Collector Current vs. Collector-Emitter Voltage
IC-IF	Collector Current vs. Forward Current
Cce-VCE	Collector-Emitter capacitance vs. Collector-Emitter Voltage

Component type: Solid State Relay

Parameters	Description
VF	LED Forward Voltage
VR	LED Reverse Voltage
IF (on)	LED Operate Current
IF (off)	LED Turn-off Current
R (on)	On Resistance
I (leak)	Off-state Leakage Current
C (out)	Output Capacitance
C (iso)	I/O Capacitance
R (iso)	I/O Isolation Resistance

Graph	Description
IF-VF	Forward current vs. Forward voltage
IL-V	Output current vs. Output voltage
I(off)-VL	Off-state Leakage current vs. Load Voltage
C(out)-VL	Output Capacitance vs. Load Voltage

Basic functions

Datasheet characterization GUI

Datasheet Characterization mode graphical user-interface (GUI) is shown in Figure 2-4.

Figure 2-4 Datasheet Characterization GUI.

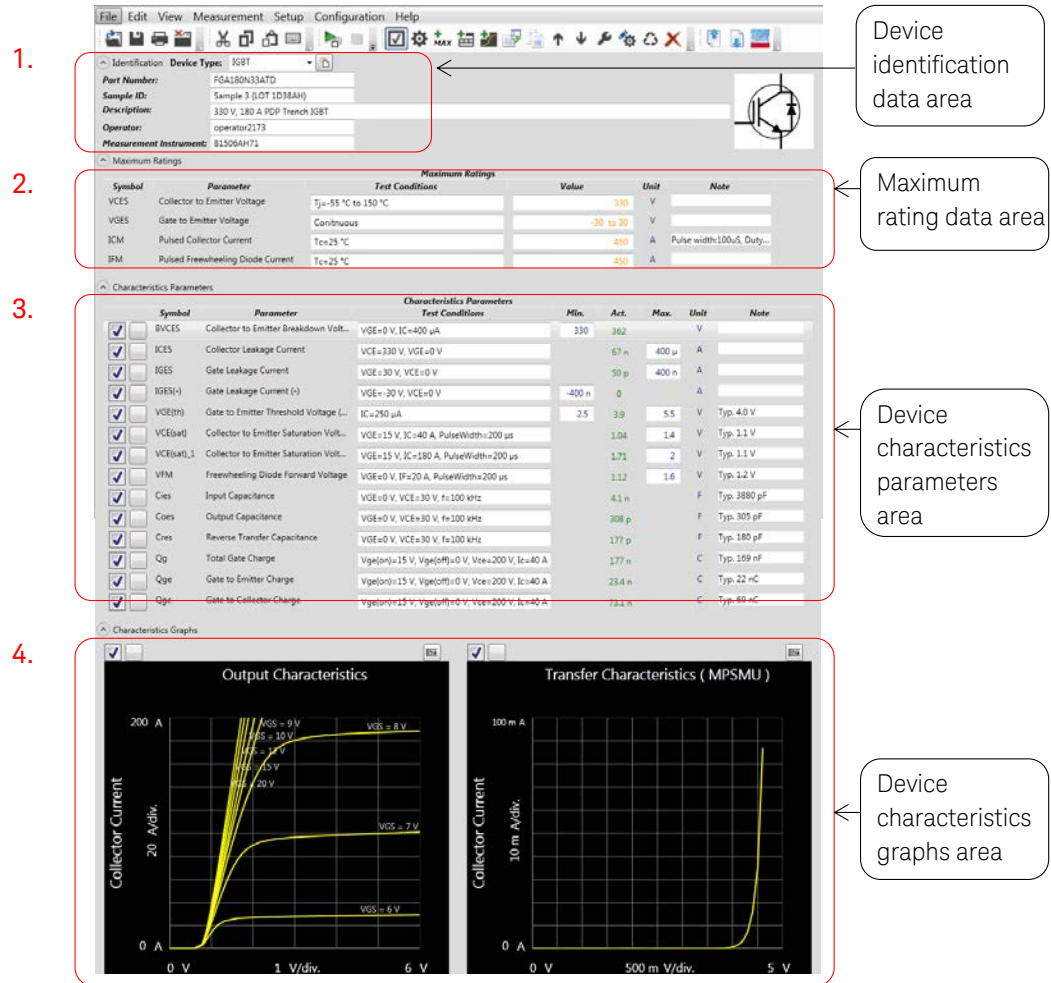

The GUI consists of the following four parts (Refer to the corresponding numbers in the figure.);

1. Device identification data area.
The device and operator information is entered in this area.
2. Maximum rating data area.
The maximum ratings of the device are entered in this area.
The test setup uses these parameters as the maximum limit when setting the test conditions.
3. Device characteristics parameters area.
This area defines the actual device parameters to measure and the test parameters.
4. Device characteristics graph areas.

This area defines the characteristics graph to measure, the test conditions and the output graph scales.

Note: In the breakdown test such as the BVDES or BVCES, the test setup uses higher voltage compliance in the default setup (typically 3 kV) than the maximum rating because the actual breakdown voltage is higher than the maximum rating value.
The device should not be damaged by the specified collector current.

Basic Functions

Datasheet measurement mode has the following test support and editing capabilities.

- ✓ Protect the test device.
The test setup is automatically limited by the maximum ratings, and the device is operated in a safe condition inside the device operation range.
- ✓ Minimum and Maximum parameter limits are checked automatically.
The measured parameters are automatically checked if they are inside the minimum and the maximum limits. If the measurement data is outside the limit, the measured parameter is shown in red color in the display.
- ✓ Modification capability of the measurement condition.
The measurement conditions can be changed in the detail measurement setup window.
- ✓ Deselect capability of specified parameters in the measurement.
You will have an option to deselect a parameter from your Datasheet Characterization test file when you start measurements. This capability is useful when only limited tests are necessary to measure.
- ✓ Duplication capability of existing device characteristic parameters to measure with a different test condition.
You can duplicate the predefined test and add as another test in a different test condition.
- ✓ Importing capability of separately measured data.
If the measurement type is the same, the existing data can be imported in the current setup including the measured data.
- ✓ Moving Up/Down a measurement item.
You can change the order the measurement.
- ✓ Adding new test parameter
You can add a new test parameter based on existing IV, CV and Qg data.
- ✓ Modification capability to create new parameter from the existing parameters.
You can create a new parameter by modifying the existing parameter

Note: How to add new parameter, refer to section “**Tips to customize a datasheet setup**” in the section headed “**Useful information for using the datasheet characterization mode**”.

Steps to measure datasheet characteristics of power device

A typical flow to measure the datasheet characteristics is described in Figure 2-5.

If the setup for specific device is available, it is possible to re-use it and you can skip the steps to modify the measurement conditions.

During the measurement, it is necessary to manually change the connection from the IV/CV measurement test module to the Qg measurement socket adapter.

Figure 2-5 Typical flow to run Datasheet Characterization mode.

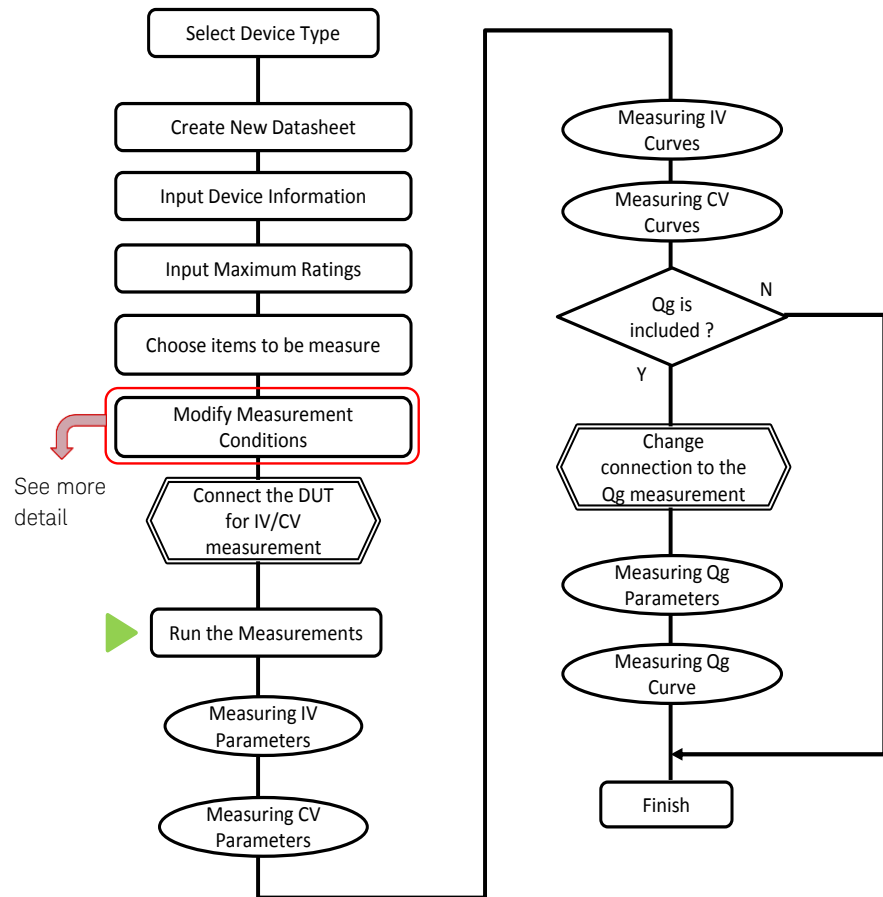

Details of measurement condition modification

The "Modify Measurement Conditions" step in Figure 2-5 is actually setting the parameters in each parameter and graph item in 3 and 4 parameter blocks in Figure 2-4.

Each line items and graphics of these items are broken down to the detailed measurement setup window shown in Figure 2-6.

This detail setup for each parameter is repeated for all the device parameters in the initial setup phase of the test device as shown in Figure 2-7.

Figure 2-6 Example of the detail measurement setup window for each device parameter.

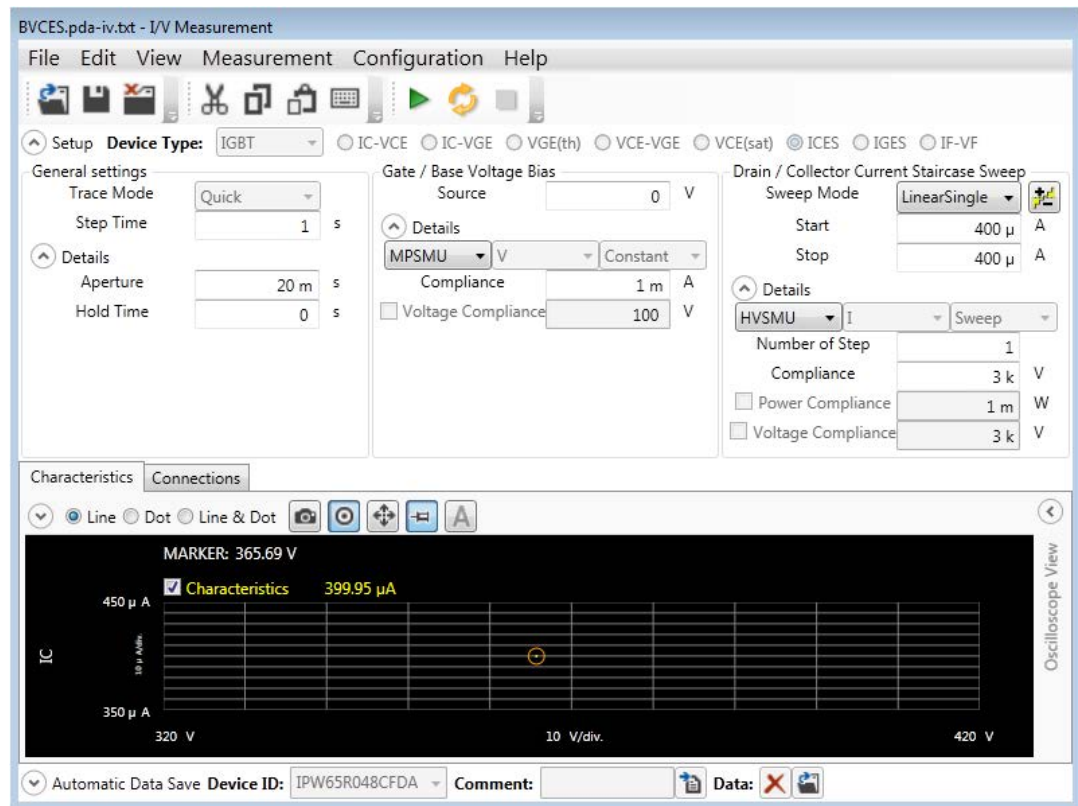
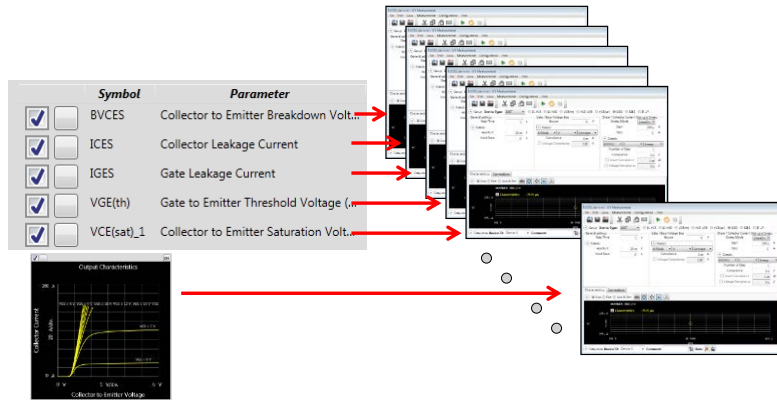

Figure 2-7

Detail measurement setup is repeated for each parameter.



An IGBT measurement example

Devices and test fixtures

Device used in the example

In this section, discrete IGBT FGA180N33ATD is used as the example test device. (See picture on the right).

This device has the following basic characteristics.

- ✓ VCES: 330 V
- ✓ VGES: +/-30 V
- ✓ IC: 180 A(DC), 450 A(Pulse)



FGA180N33ATD
IGBT

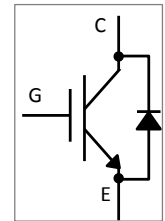
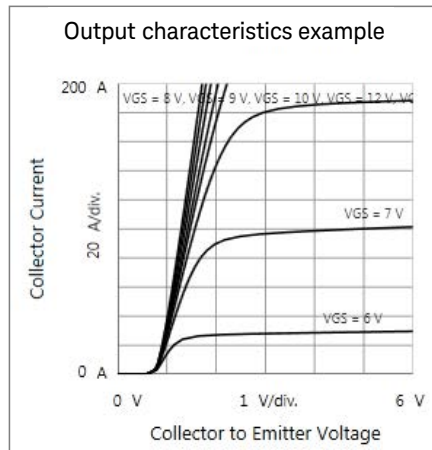

Test conditions for each measurement parameters for Datasheet Characterization function are picked up from the datasheet of the device.

IV and CV test socket module

To measure IV and CV characteristics, B1506A Opt. F10 3 pin Inline Package Socket Module is used as shown in Figure 2-8.

Figure 2-8

B1506A Opt. F10 3 pin Inline Package Socket Module, and IGBT setting on the socket.



Gate charge test socket adapter

To measure the gate charge parameters, B1506A Opt. F14 Gate charge measurement adapter shown in Figure 2-9 is used.

In this section, the constant current load method is used to measure the gate charge of the device under test (DUT). The left hand TO socket is used to attach the current load FET (IXTH200N). The DUT is attached to the right-hand TO socket.

Note:

To measure Q_g of the DUT attached to the TO socket, the DUT selector switch has to be set to “Internal Package”. Also, the shorting bar has to be attached to the collector/drain sense terminals for external DUT measurement as shown in Figure 2-10.

Figure 2-9 B1506A Opt. F14 Gate charge measurement adapter.

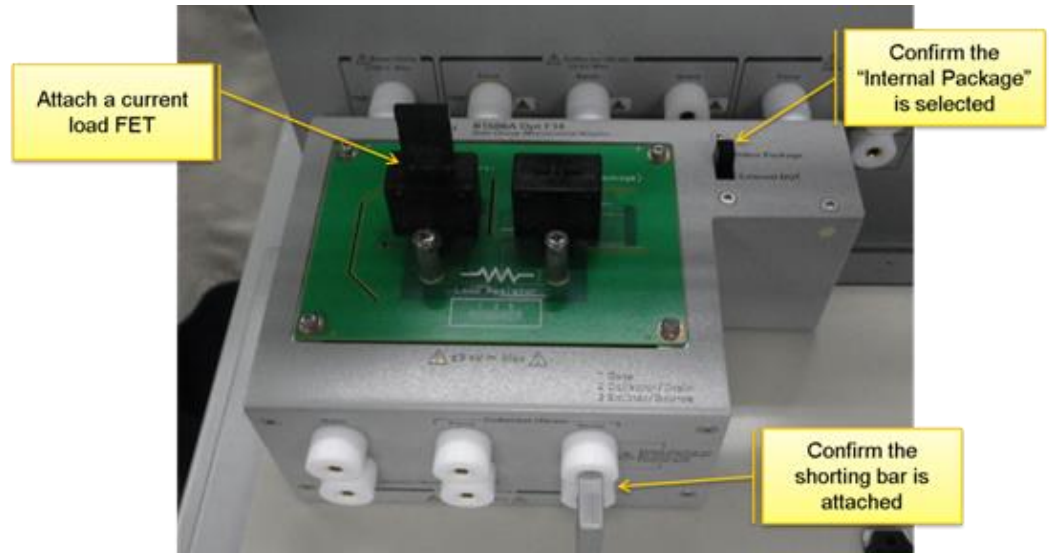
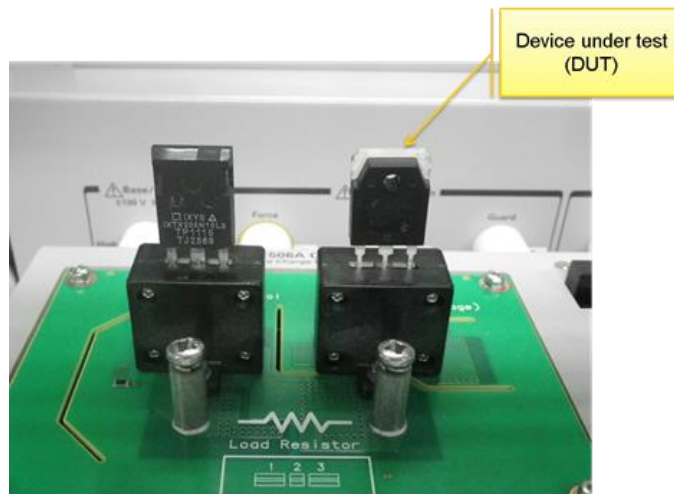

Figure 2-10 Current load FET (IXTH200N (Left), and the DUT (Right).



Measurement Steps

Following shows the measurement steps of the Datasheet Characterization mode.

Step 1

Starting the datasheet characterization mode

Click “Datasheet Characterization”. (Figure 2-11)

The datasheet characterization mode is launched.

Initially, a blank datasheet characterization setup as shown in Figure 2-12 opens.

Figure 2-11

Click “Datasheet Characterization”.

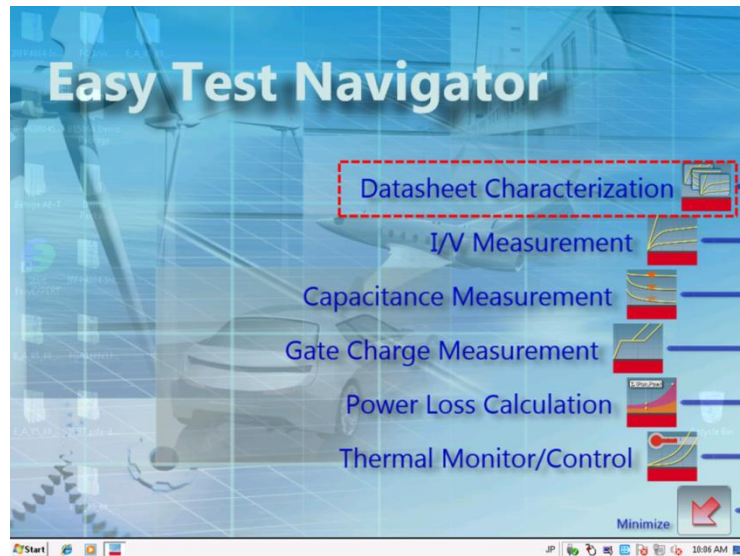
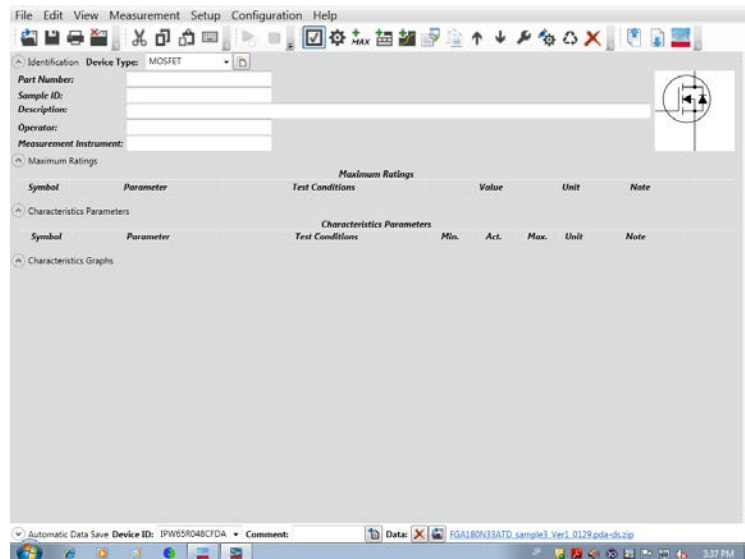

Figure 2-12

A blank datasheet characterization setup panel opens.



Step 2

Creating a new datasheet definition

Follow the next steps to open the new datasheet template by referring to Figure 2-13.

- Select a device type from the pull down list.
- Click the "New Datasheet" button.
- Click the "OK" button of the confirmation window.
- IGBT datasheet template opens.

Figure 2-13 Steps for creating a new datasheet definition.

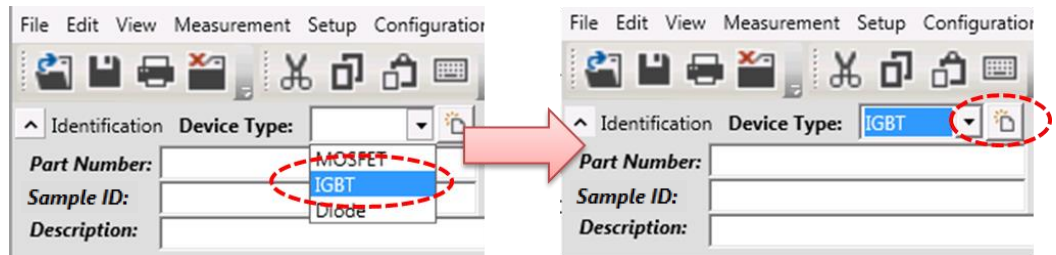

(a) Select a device type - IGBT.

(b) Click the "New Datasheet" button .



(c) Click "OK" button.

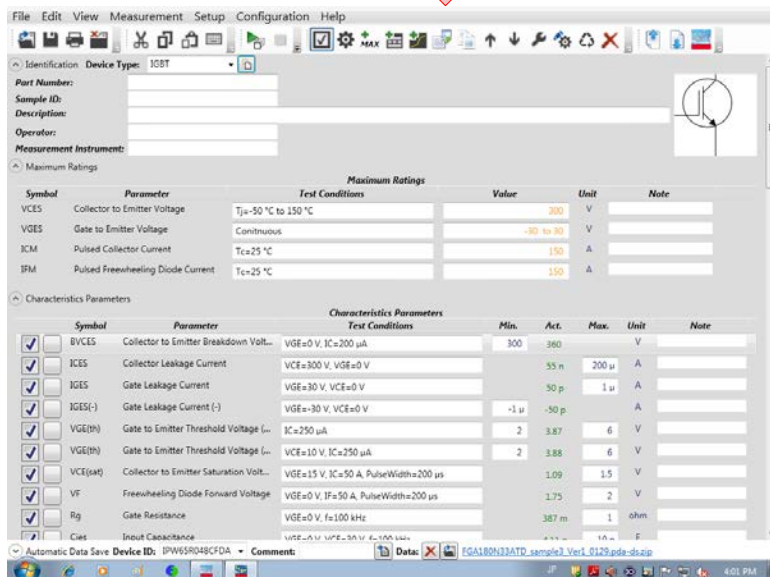

(d) Template of IGBT Datasheet..

Step 3

Input the device information

Input the device information to the Identification section of the datasheet template as shown in Figure 2-14.

Figure 2-14

Example of the Identification section of the demo device.

^ Identification		Device Type:	IGBT
1.	Part Number:	FGA180N33ATD	
2.	Sample ID:	Sample 1	
3.	Description:	Fairchild: 330 V, 180 A PDP Trench IGBT	
4.	Operator:	Keysight Application Development	
5.	Measurement Instrument:	B1506A H71 Demo Equipment #1	

Using a part number and device description including the manufacturer information (Figure 2-15 as an example) are recommended to identify the device in detail in the future use.

Enter the following information:

1. Part number:
Device name from the datasheet.
2. Sample ID:
Describes the information to individualize each sample device.
3. Operator name:
4. Measurement instrument sections:
These are used to note information to identify measurement situations. For example, like who has measured it or what equipment is used to measure the data.

These information are recorded in the test result file.

Figure 2-15

Datasheet description example.

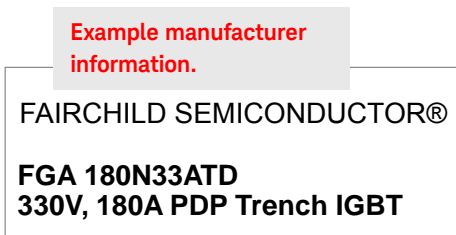

- ✓ Input the device ID in the bottom of the panel. (Figure 2-16)
This device ID is used as a header of the file name to store the measurement results.

Figure 2-16 Device ID in the bottom of the panel

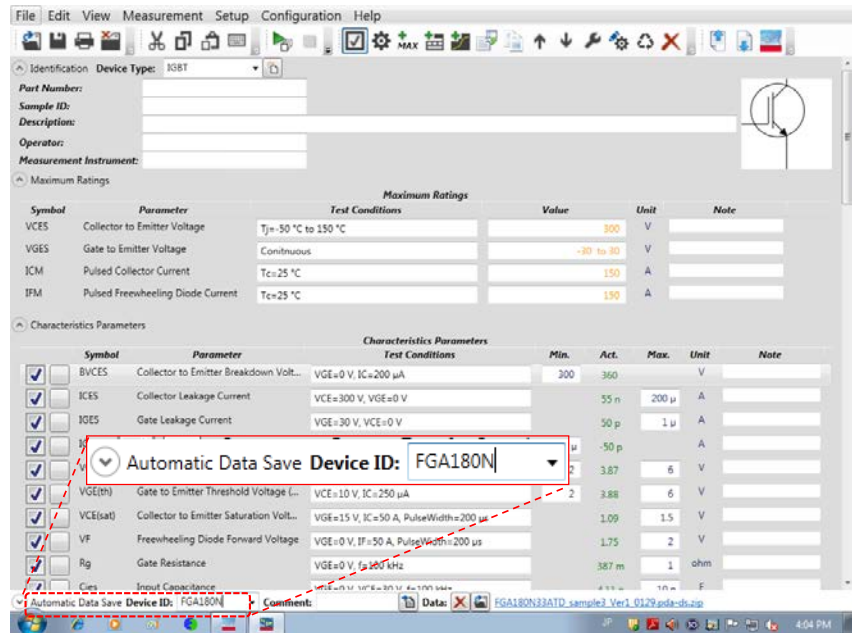

Tips:

How to change the device picture:

Refer to the section "Tips: How to change the picture of the device"

Step 4

Input the maximum ratings

Input the maximum ratings of the device in the Maximum Ratings section. The ratings specified in this part are used to limit the applied voltage/current, and they protect the device during the measurement

Figure 2-17 shows the maximum ratings picked up from the FGA180N33ATD's datasheet.

Figure 2-17

Absolute Maximum ratings described in the datasheet of the example demo device.

Absolute Maximum Ratings

Symbol	Description	Ratings	Unit
VCES	Collector to Emitter Voltage	330	V
VGES	Gate to Emitter Voltage	± 30	V
IC	Collector Current @ TC = 25°C	180	A
ICM (1)	Pulsed Collector Current @ TC = 25°C	450	A
TJ	Operating Junction Temperature	-55 to +150	°C

To input the maximum ratings:

Follow the next steps to input the maximum ratings of Figure 2-17 by referring to the number shown in Figure 2-18.

1. Click the parameter to be modified.
2. Then the parameter input field changes to edit mode.
In the example, Tj Min., Max and VCES max value are changed.
3. Modify the VCES value field based on the datasheet (Figure 2-17).
4. Enter Tj Min., Max.
Note:
Tj parameters are used for reference only, not for actual measurements.
5. After modifying the value, click the “x” button to exit the edit mode.
6. Set all the other parameters' maximum ratings in the same way by referring to the above steps from 1 to 5.

Note:

For maximum current rating of ICM, sine the B1506A uses pulsed measurement mode to measure it, choose the maximum rating defined in the pulse current mode.

Figure 2-19 shows the maximum ratings section after all the parameters have been entered for FGA180N33ATD.

Figure 2-18 Editing the VCES maximum rating and the other maximum ratings.

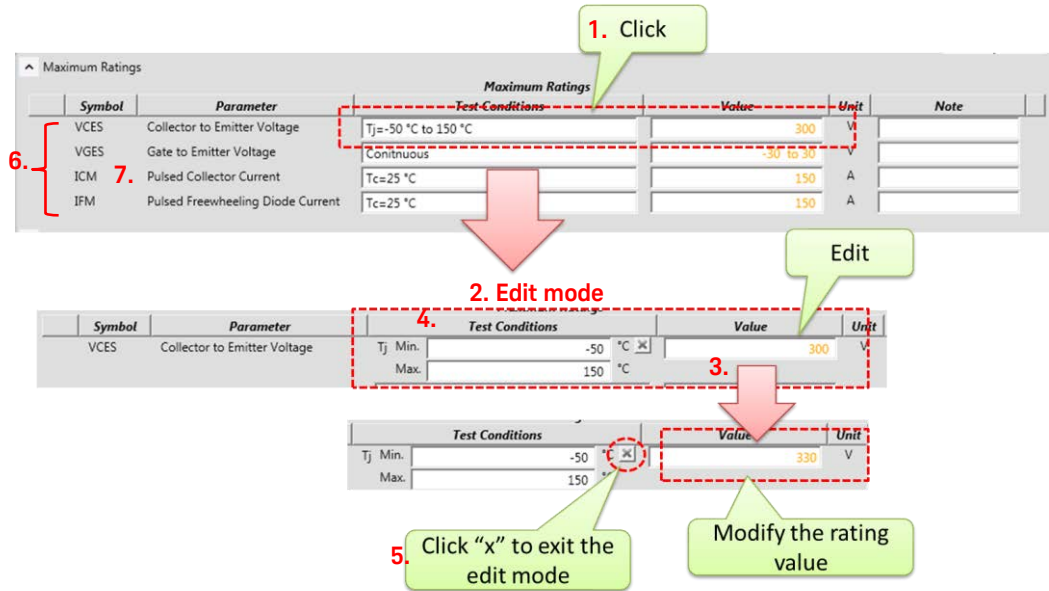

Note: If the maximum current of the freewheeling diode is not described in the datasheet, typically it is the same as the maximum collector current. Use the maximum collector current as an IFM.

Figure 2-19 Maximum ratings section for FGA180N33ATD.

Symbol	Parameter	Test Conditions	Value	Unit
VCES	Collector to Emitter Voltage	T _J =-50 °C to 150 °C	330	V
VGES	Gate to Emitter Voltage	Continuous	-30 to 30	V
ICM	Pulsed Collector Current	T _c =25 °C	450	A
IFM	Pulsed Freewheeling Diode Current	T _c =25 °C	450	A

Tips How to change the symbol name or description:
Refer to the section named “**Tips: How to change the symbol name and the description**” in the section headed “Useful information for using the datasheet characterization mode”.

Tips How to add an item to the section of maximum ratings
Refer to the section named “**Tips: How to add a new item to the maximum ratings**” in the section headed “Useful information for using the datasheet characterization mode”.

Step 5

Creating a setup for the characteristics parameters section

This step demonstrates how to create each measurement setup for the following device parameter characteristics.

- 5.1 BVCES
- 5.2 ICES
- 5.3 IGES
- 5.4 VGE(th) (gate-drain connected)
- 5.5 VGE(th) with constant VCE
- 5.6 VCE(sat)
- 5.7 Transconductance (gfs)
- 5.8 VF of freewheeling diode
- 5.9 Other IV parameters
- 5.10 Rg internal gate resistance
- 5.11 Capacitance (Cies, Coes, Cres)
- 5.12 Gate charge (Qg, Qge, Qgc)

5.1 BVCES

BVCES is defined as the collector voltage at the specified collector current when applying VCES to the collector while keeping the device turned off.

How to set up BVCES test condition parameters

Modify the test conditions based on the conditions described in the datasheet. For example, here is a description of BVCES in the datasheet. VBCES is defined as the collector voltage when the collector current is 400 μ A with 0 V gate to emitter voltage.

Symbol	Parameter	Test Conditions	Min.	Typ.	Max.	Unit
Off Characteristics						
BVCES	Collector to Emitter Breakdown Voltage	VGE = 0V, IC = 400 μ A	330	-	-	V

To modify the test conditions, (refer to Figure 2-20)

- ✓ Click the parameter area to move into the edit mode.
- ✓ Modify the test conditions and ratings the according to the datasheet.

Figure 2-20

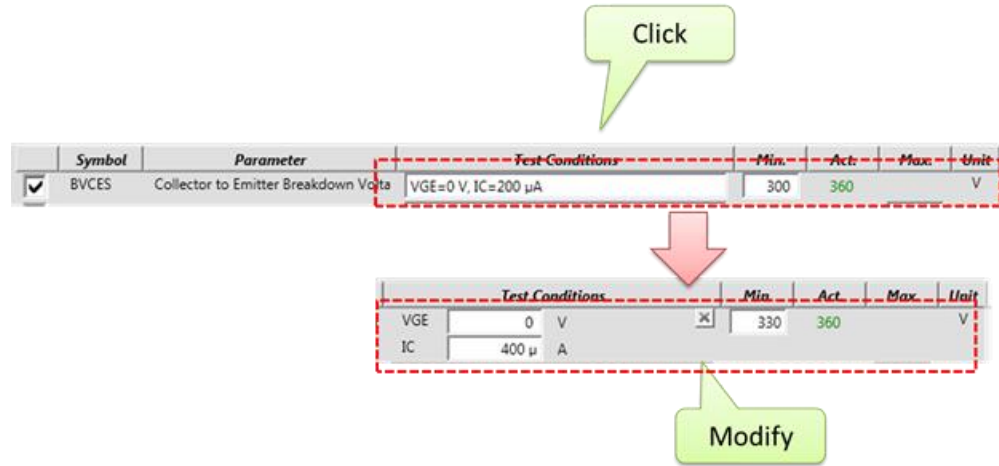

Note: Normally, only the minimum value is defined for BVCEs in the datasheet. But, it is possible to add a maximum limit in addition to the minimum limit if necessary. To add the maximum or minimum limit to the item, refer to section “**Tips: How to add the minimum / maximum limit**”.

How to set up the detailed I/V measurement parameters

To create a new measurement setup for a new device parameter, or to verify the existing individual setup, or to modify the measurement setup in details, open the corresponding setup window from one of the following two ways.

Method 1: Open Setup from the pop up menu:

- ✓ Right-click the parameter to be modified excepting the input parameters. (Refer to Figure 2-21.)
- ✓ Select “Setup” from the pop-up menu.

Figure 2-21

Selecting setup from the pop up menu.

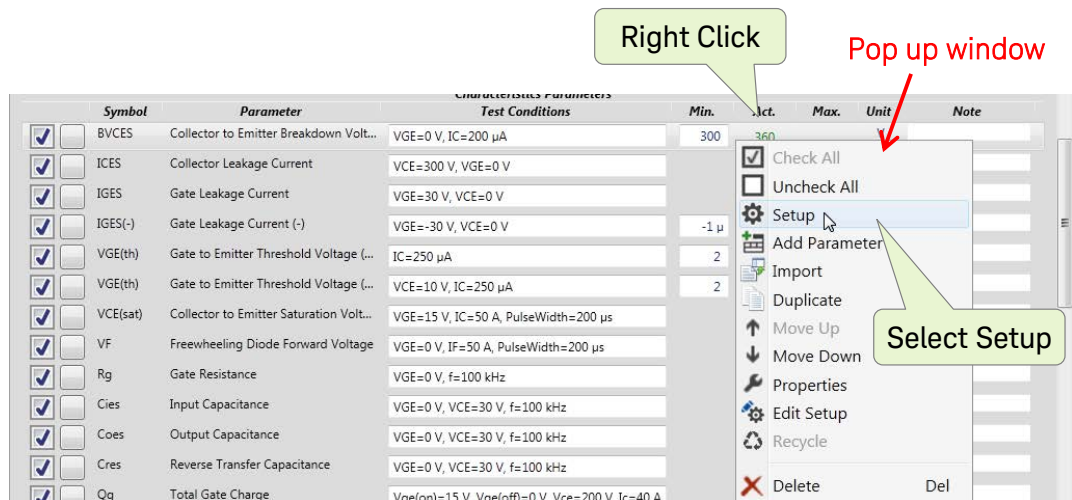

Method 2: Open Setup from the ribbon menu of the Datasheet Characterization mode panel (Figure 2-22).

- ✓ Click the parameter to be modified excepting the input parameters.
- ✓ Click the setup button in the ribbon menu.

Figure 2-22 Selecting setup from the ribbon menu.

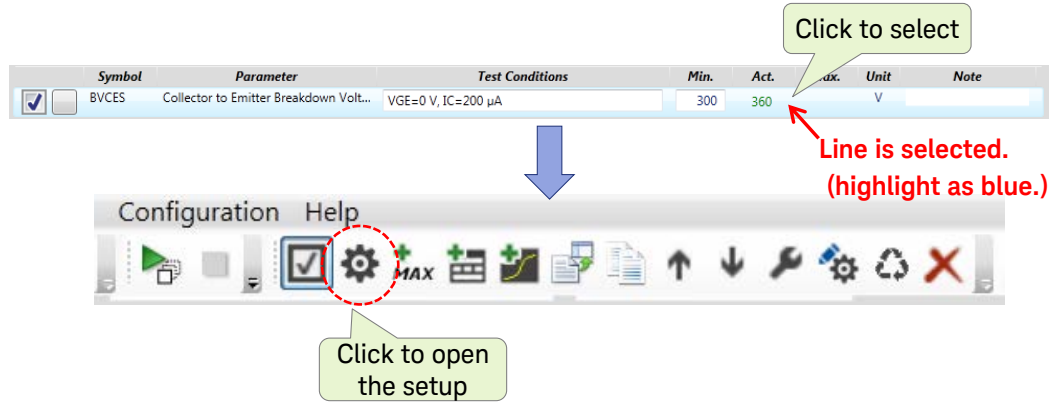

- ✓ Corresponding setup is opened. (Figure 2-23)

The following explains the BV CES I/V measurement setup. Refer to the corresponding numbers shown in the figure.

1. For BV CES measurement, the “ICES” preset of the IV measurement mode is used (the measurement item cannot be changed in this mode. To change it, refer to section “**Tips: How to change locked parameter in the setup**”).
2. To see the detailed setup, click the down arrow on the left side of the “Details” label.

Figure 2-23 BVCES I/V Measurement panel.

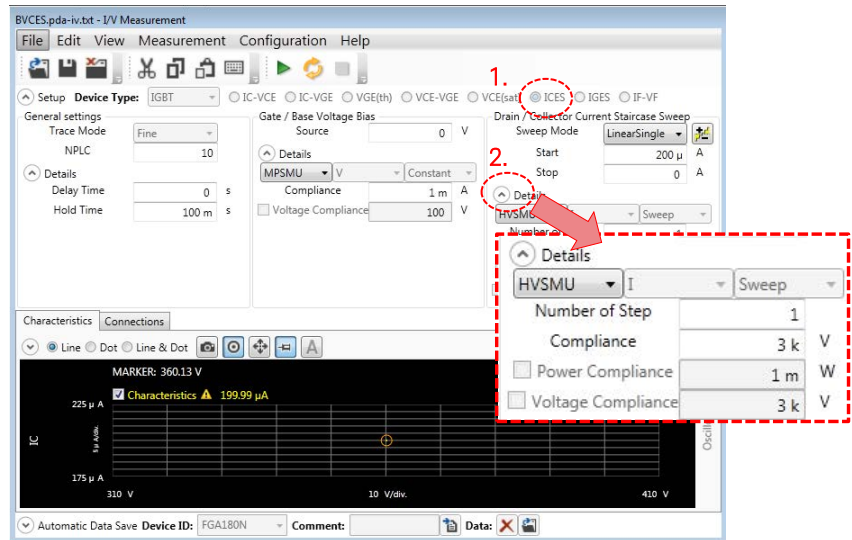

The detail of the BVCES parameter setup is shown in Figure 2-24.

Figure 2-24 Detail of the BVCES I/V Measurement setup.

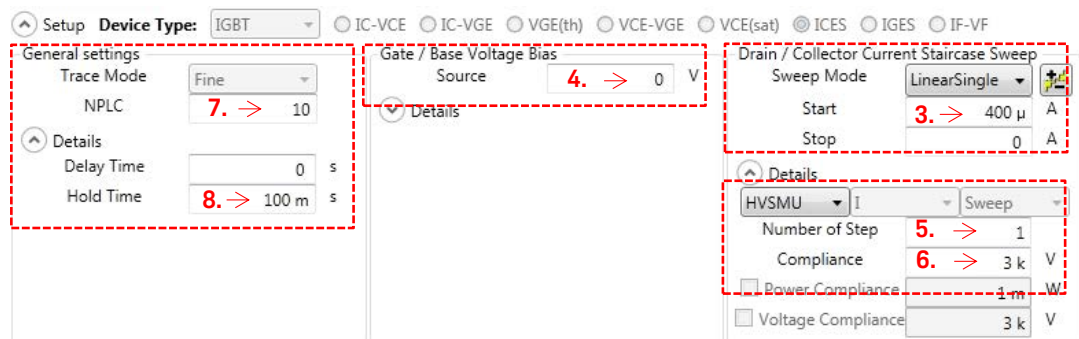

- ✓ To measure BVCES, the HVSMU forces 400 μA in constant current mode and measures the collector voltage.
- 3. The start current is set as 400 μA , which is taken from the Test Conditions of the VBCES.
- 4. The gate voltage is set as 0 V, which is taken from the Test Conditions of the VBCES.
- 5. The Number of Steps is set as 1 to do a single spot measurement at the start value.
- 6. The Voltage compliance used in this measurement is larger than the maximum rating of the device because BVCES is normally larger than it, and the device should not be damaged by the specified collector current.

7. It is possible to modify the measurement setup in details here (example: Hold time, Delay time and Meas. Time).

To see the detailed setup, click the down arrow on the left side of the “Details” label.

The NPLC mode of measurement time is used. NPLC stands for number of power line cycle (1 PLC = 20 ms @ 50 Hz region, 16.67 ms @ 60 Hz region) and it is effective to reduce measurement noise coming from the commercial power line. Also, to reduce a random noise on measured data, measurement time should be long enough. In this setup, 10 PLCs of measurement time is used for precision leakage current measurement.

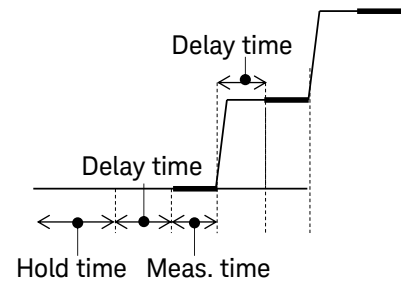

8. The hold time should be long enough to wait for the settling of the voltage and the current.

Note:

To measure BVCES with small IC accurately, the fine mode is used in the IV measurement mode. It uses limited auto ranging to use an appropriate measurement range and PLC mode of measurement time to reduce measurement noise coming from the commercial power source. The fine mode is only available when DC bias mode (V or I) is used. When using pulsed bias mode (VPulse or IPulse), the quick mode is used. In the quick mode, measurement timing is defined as step time or pulse with, and aperture.

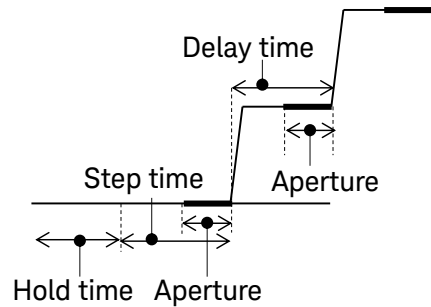

Verification of the BVCES measurement setup

After the detail I/V measurement setup is finished, it is recommended to perform the verification of the measurement setup. Follow the next steps by referring to the number in Figure 2-25

9. Click the measure button and the measurement result is displayed in the graph area.
10. In this case, measured BVCES is 334.45 V.
11. To save the test setup and the test result to the datasheet level, save the setup by selecting “File”-->”Save”. The actual value in the datasheet is updated (Figure 2-26).

Figure 2-25 Execution of the BVCES I/V measurement.

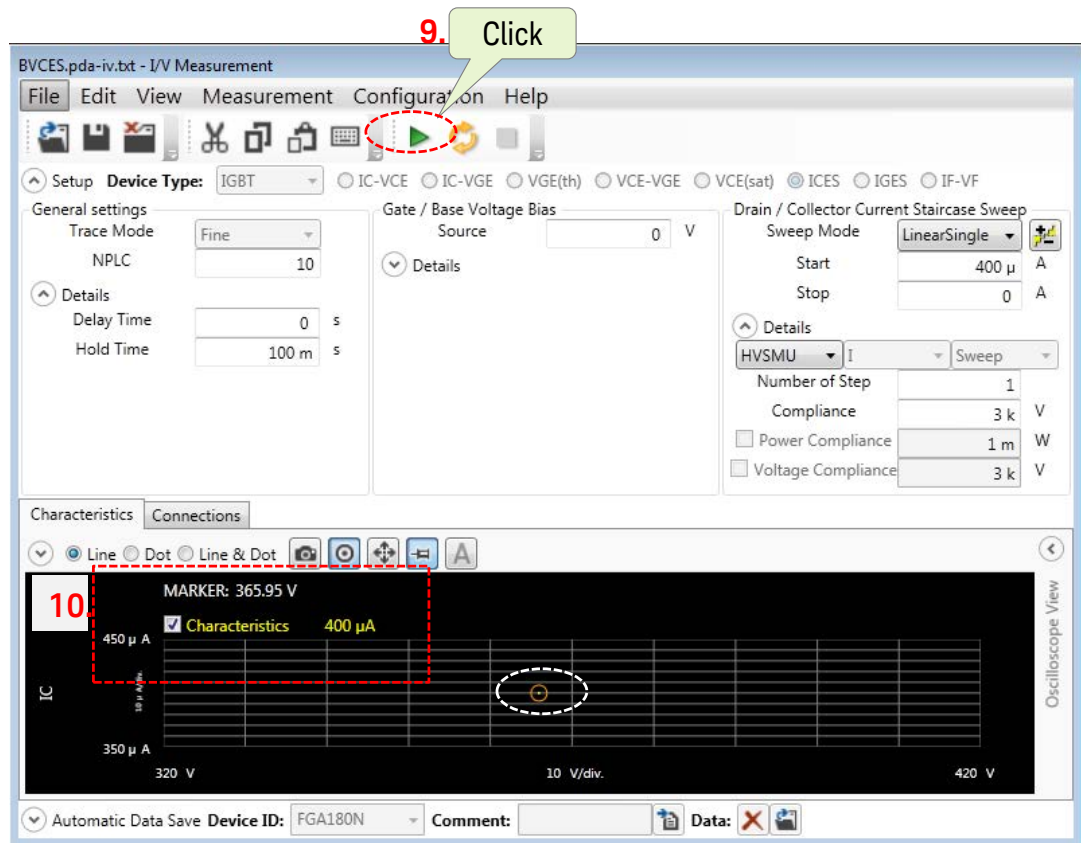

Figure 2-26 Update on the datasheet result.

11.

Symbol	Parameter	Test Conditions	Min.	Act.	Max.	Unit
<input checked="" type="checkbox"/>	BVCES	Collector to Emitter Breakdown Volt...	VGE=0 V, IC=400 μA	330	348	V

Note: If you change any of the optional parameters and to reflect the change, save the setup by selecting “File”-->”Save”.



5.2 ICES

ICES is defined as the collector current when applying specified VCES to the collector while keeping the device turned off.

To set up ICES test conditions and I/V measurement parameters

Modify test conditions based on the conditions described in the datasheet. For example, here is a description of ICES in the datasheet. ICES is defined as the maximum collector current as 400 μA when the collector voltage is VCES with 0 V gate to emitter voltage.

Symbol	Parameter	Test Conditions	Min.	Typ.	Max.	Unit
Off Characteristics						
BVCES	Collector to Emitter Breakdown Voltage	VGE = 0V, IC = 400 μA	330	-	-	V
ICES	Collector Cut-Off Current	VCE = VCES, VGE = 0V	-	-	400	μA

To modify the test conditions (refer to Figure 2-27)

- ✓ Click the parameter area to move into the edit mode.
- ✓ Modify the test conditions and ratings according to the datasheet.

Figure 2-27 ICES Test Conditions

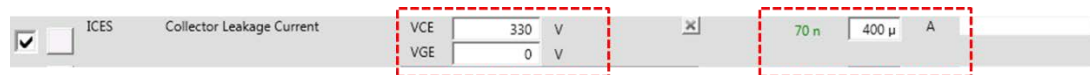

- ✓ Open the ICES I/V measurement setup panel (Figure 2-28).

Following explains the ICES I/V measurement setup. Refer to the corresponding numbers shown in the figure.

1. In the background of the ICES measurement, “ICES” measurement template of the IV measurement mode is used.
2. For drain/collector biasing, the HVSMU is operated in Voltage force mode.
3. HVSMU operates with a single step sweep measurement of 330 V start voltage (only the first step with the start voltage is measured).
4. Gate voltage bias is taken from the datasheet input.

Note: The start voltage of the drain/collector voltage staircase sweep and the source voltage of the gate/base voltage bias are inherited from the test conditions defined in the datasheet mode.

Note: The current compliance is automatically defined as 10 times of the maximum limit defined in the upper level (datasheet mode). It can be changed by editing the property of the test parameter (refer to “**Tips: How to change the association of the test conditions with the measurement setup**”).

5. 10 PLCs of measurement time is used as a default value and, typically, it is long enough.
6. 100 ms of Hold Time is used as a default value. If the compliance value is very small, it is necessary to make it long enough to charge up the capacitance of the device before measuring ICES. Since “Fine” mode uses limited auto ranging, measurement resolution is not degraded even if large current compliance is used.

Figure 2-28 ICES I/V Measurement panel.

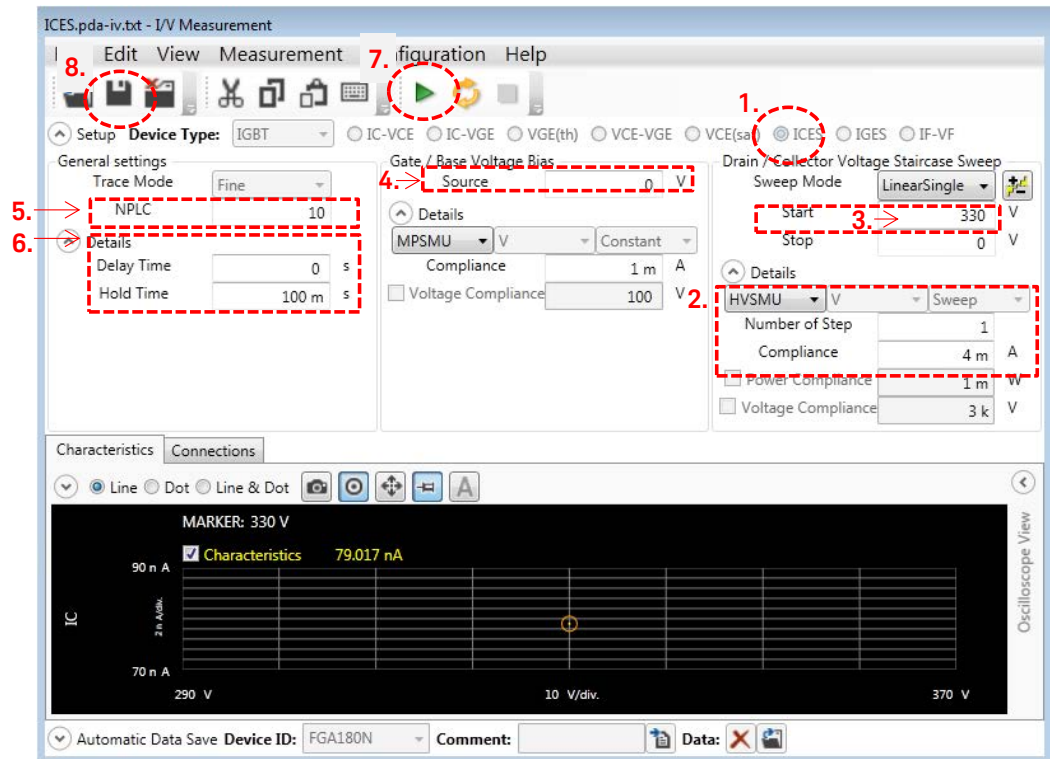

Verification of the ICES measurement setup

After the detail I/V measurement setup is finished, it is recommended to perform the verification of the measurement setup. Follow the next steps by referring to the number in Figure 2-28

7. Click the measure button, and the measurement result is displayed in the graph area.
8. To save the test setup and the test result in the datasheet, save the setup by selecting “File”-->”Save”.

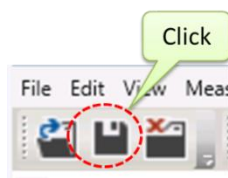

5.3 IGES

IGES is defined as the gate leakage current at VGES both in positive and in negative voltages.

How to set up IGES measurement parameters

Modify test conditions based on the conditions described in the datasheet. For example, here is a description of ICES in the datasheet.

Symbol	Parameter	Test Conditions	Min.	Typ.	Max.	Unit
Off Characteristics						
BVCES	Collector to Emitter Breakdown Voltage	VGE = 0V, IC = 400μA	330	-	-	V
ICES	Collector Cut-Off Current	VCE = VCES, VGE = 0V	-	-	400	μA
IGES	G-E Leakage Current	VGE = VGES, VCE = 0V	-	-	±400	nA

Note: In the datasheet characterization mode, since only single test condition can be specified at one measurement item, it is necessary to separate the IGES measurement into two parts, positive and negative biased conditions.

To modify the test conditions, (refer to Figure 2-29)

- ✓ Click the parameter area to move into the edit mode.
- ✓ Modify the test conditions and ratings according to the datasheet.
 1. IGES is used for positive biased measurement and IGES(-) is used for negative biased measurement.
 2. For IGES, input the same test conditions as in the datasheet (VGE = 30 V, VCE = 0 V and the max. limit = 400 nA).
 3. For IGES(-), the signs of all parameters are reversed and the max. limit is converted to the min. limit. (VGE = -30 V, VCE = 0 V and the max. limit = -400 nA)

Figure 2-29 IGES Test Conditions.

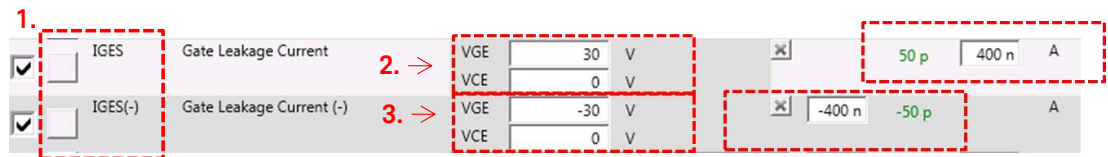

- ✓ Open the IGES I/V measurement setup panel. (Figure 2-30)

Following explains the IGES I/V measurement setup. Refer to the corresponding numbers shown in the figure.

4. In the background of the IGES measurement, “IGES” template of the IV measurement mode is used.
5. For gate/bias voltage staircase bias, the MPSMU is used in Voltage force mode with a single step sweep measurement.
6. The single step of 30 V is set as the Start voltage (only the first step with the start voltage is measured).

Note: The start voltage of the gate/base voltage staircase sweep and the source voltage of the drain/collector voltage bias are inherited from the test conditions defined in the datasheet mode (30 V and 0 V).

7. The current compliance of gate bias is automatically defined as + 1 mA to the maximum limit defined in the upper level (datasheet mode). Since the current compliance is determined by the maximum limit defined in the datasheet mode, it is not allowed to remove it. To change/remove association between the maximum limit and the current compliance, refer to **“Tips: How to change the association of the test conditions with the measurement setup”**.
8. Fine mode is used to measure leakage current accurately. Hold time determines the wait time before measurement after applying the bias. In this case after waiting 1 s, ICE is measured with 10 PLCs of measurement time (1 PLC = 1/ Frequency of commercial power source).

Note: If the input capacitance of the gate of the DUT is large and the current compliance is small, the default wait time (1 s) is possibly not enough to charge the gate input capacitance due to the charge current limitation by the current compliance.

- ✓ If the wait time is not long enough, the measured current exceeds the maximum limit defined as the test conditions in the datasheet mode, and it reaches the current compliance value.
- ✓ In such a case, set a longer Step Time, for example, 2 seconds.

Figure 2-30 IGES I/V Measurement panel.

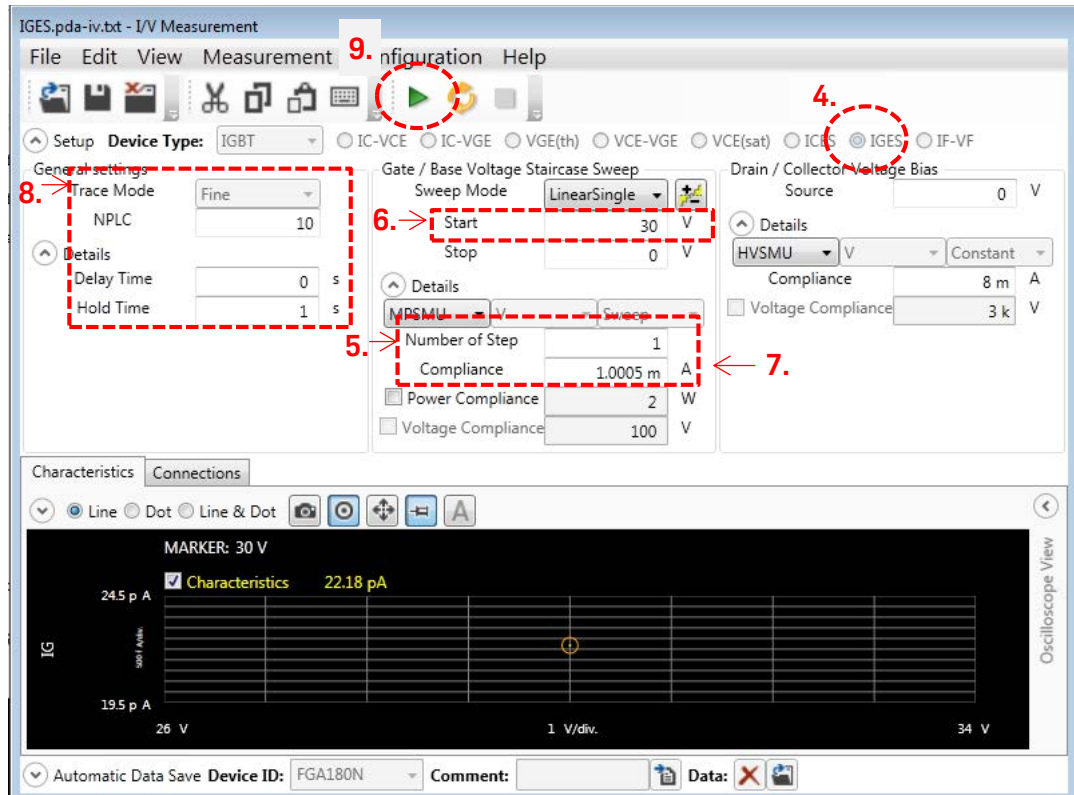

Verification of the IGES measurement setup

After the detail I/V measurement setup is finished, it is recommended to perform the verification of the measurement setup. Follow the next steps by referring to the number in Figure 2-30

9. Click the measure button, and the measurement result is displayed in the graph area.
- ✓ To save the test setup and the test result in the datasheet, save the setup by selecting "File"-->"Save".



For IGES(-): IGES(-) I/V measurement setup and verification

Repeat the I/V measurement setup and verification for IGES(-) parameters by opening the IGES(-) I/V measurement setup panel.

5.4 VGE(th)

Gate threshold voltage, VGE(th) is defined as the gate voltage when the specified collector/drain current flows with the specified collector/drain bias condition.

Typically, in the datasheet of the power devices, the gate to emitter voltage VGE is defined as being the same as the collector voltage VCE. It means that the gate and the collector of the DUT are connected together.

How to set up VGE(th) measurement parameters

Modify test conditions based on the conditions described in the datasheet. For example, here is a description of VGE(th) in the datasheet. VGE(th) is defined at IC = 250 μA, VCE = VGE.

Symbol	Parameter	Test Conditions	Min.	Typ.	Max.	Unit
On Characteristics						
VGE(th)	G-E Threshold Voltage	IC = 250μA, VCE = VGE	2.5	4	5.5	V
		IC = 40A, VGE = 15V	-	1.1	1.4	V
VCE(sat)	Collector to Emitter Saturation Voltage	IC = 180A, VGE = 15V,	-	1.68	-	V
		IC = 180A, VGE = 15V TC = 125°C	-	1.89	-	V

Note:

Vth measurement method selection:

In the setup of the datasheet characterization mode, there are two kinds of VGE(th) setup as shown in Figure 2-31.

- ✓ The upper one is used to measure VGE(th) with condition of VGE = VCE. So there is no condition of VCE. When using this setup, the gate and the collector of the DUT are connected physically by the switch in the B1506A test fixture.
- ✓ The lower setup is used to measure the threshold voltage by applying constant collector voltage from SMU.

Figure 2-31

Two types of Vth measurement methods of the B1506A.

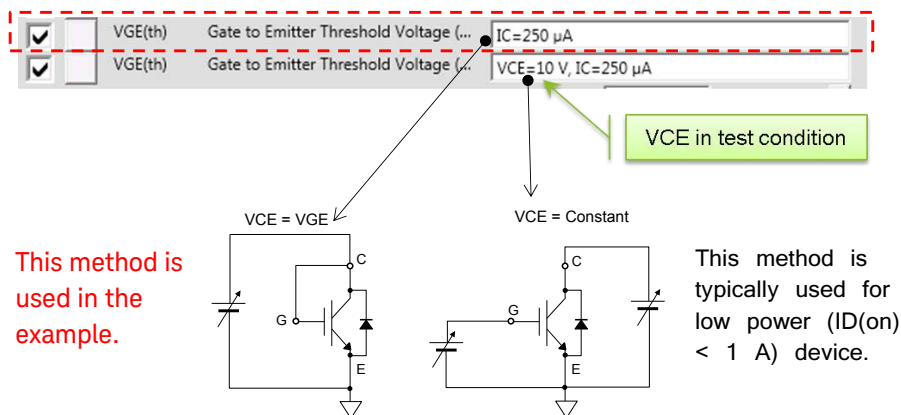

To measure VGE(th) of the DUT used in this section, the upper side measurement method is used as shown in Figure 2-31.

To modify the test conditions, (Figure 2-32)

- ✓ Click the parameter area to move into the edit mode.
- ✓ Modify the test conditions and ratings according to the datasheet.

Figure 2-32 VGE(th) test conditions used in the example.

	Symbol	Parameter	Test Conditions	Min.	Act.	Max.	Unit	Note
<input checked="" type="checkbox"/>	VGE(th)	Gate to Emitter Threshold Voltage (...)	IC=250 μA	2.5	3.87	5.5	V	Typ. 4.0 V

Note: If a typical value is listed in the datasheet, it is useful to input the value in the “Note” section as a reference.

- ✓ Open the ICES I/V measurement setup panel. (Figure 2-33)
- ✓ Following explains the VGE(th) I/V measurement setup. Refer to the corresponding numbers shown in the figure.
 1. The “VGE(th)” template of the IV measurement is used for this measurement.
 2. Same MPSMU are used for both gate/base current staircase sweep and drain/collector current staircase sweep.
 3. The current output mode of the MPSU is used and the start value of the current sweep is inherited from the test conditions in the datasheet mode.
 4. By forcing the specified current, it is possible to measure VGE(th) with a single spot measurement.
 5. The compliance voltage is defined from the maximum voltage defined in the datasheet mode.

Note: Since the voltage compliance is determined by the maximum limit defined in the datasheet mode, it is not allowed to remove it. To change/remove association between the maximum limit and the current compliance, refer to “**Tips: How to change the association of the test conditions with the measurement setup**”.

Figure 2-33 VGE(th) test setup.

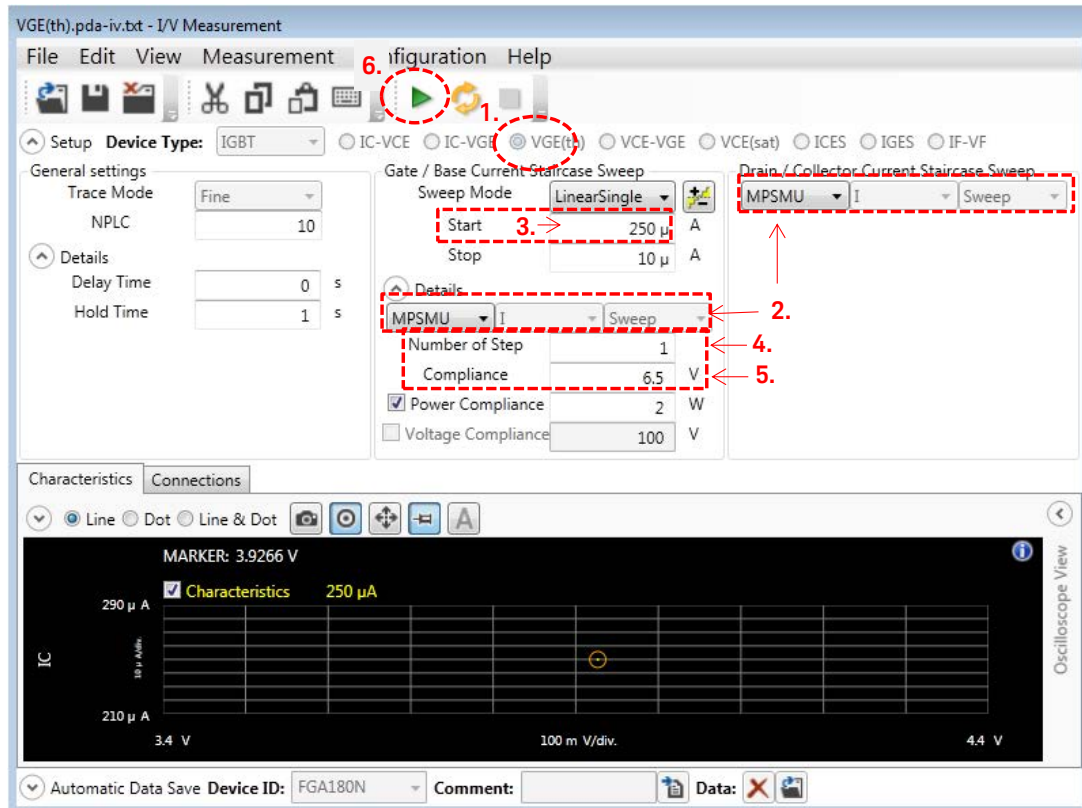

Verification of the VGE(th) measurement setup

After the detail I/V measurement setup is finished, it is recommended to perform the verification of the measurement setup. Follow the next steps by referring to the number in Figure 2-33

6. Click the measure button, and the measurement result is displayed in the graph area.
- ✓ To save the test setup and the test result in the datasheet, save the setup by selecting “File”-->”Save”.



5.5 VGE(th) with constant VCE

Since there is no definition of VGE with constant VCE in the datasheet of the sample DUT, in this section, the procedure for making a setup of the parameter is described without referring the datasheet.

How to delete the existing item

If you need to delete the existing item, right-click on it, and select “Delete” from the pop-up menu (Figure 2-34), or select the item and click the delete button in the ribbon menu (Figure 2-35).

Figure 2-34 Deleting the VGE(th) test setup by right clicking the test definition.

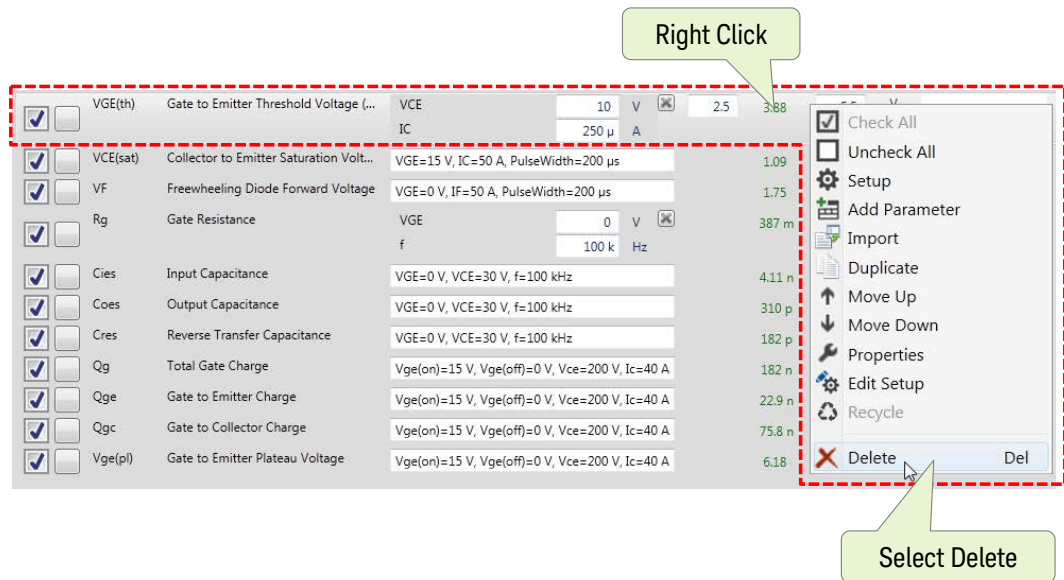
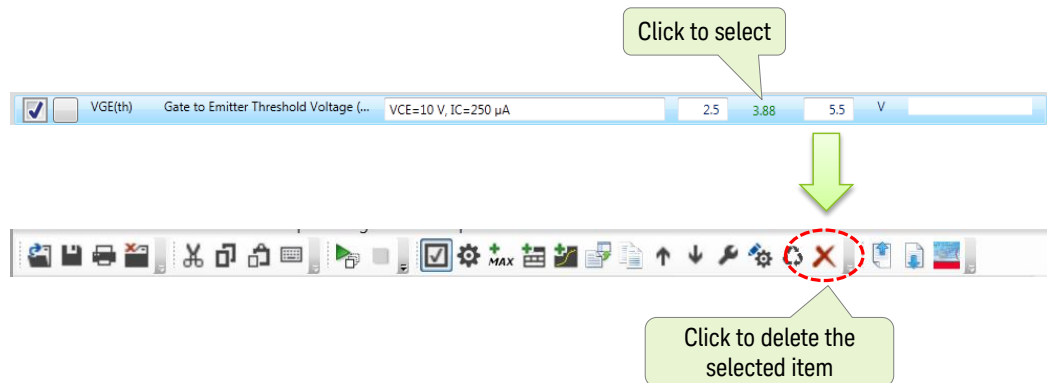

Figure 2-35 Deleting the VGE(th) test setup using the setup ribbon menu.



It is possible to select multiple items by Ctrl+Click or Shift+Click and delete them all at once.

How to set up the VGE(th) measurement with constant VCE measurement

Figure 2-36 shows test conditions of the VGE(th) with constant VCE in this section.

Figure 2-36 VGE(th) with constant VCE test conditions used in the example.



- ✓ Open the ICES I/V measurement setup panel. (Figure 2-37)

The following explains the VGE(th) I/V measurement setup. Refer to the corresponding numbers shown in the figure.

1. The “IC-VGE” template of the IV measurement is used for this measurement.
2. The gate voltage is swept from 1.5 V to 6.5 V in constant step (staircase sweep). The start and stop value of the sweep are automatically determined from the minimum and the maximum limit defined in the datasheet level. As a default, the minimum limit -1 V is used as the start voltage, and the maximum limit +1 V is used as the stop voltage. The associations between them are defined in the properties of the parameter.
3. The MPSMU is used to apply constant VCE = 10 V with 250 µA compliance.
4. The step number of the gate voltage sweep should be large enough to make the gate voltage step precise enough to measure the VGE(th).
 - ✓ The current compliance should be large enough to charge the gate capacitance fast enough.
 - ✓ The power compliance must be checked to enable the “STOP AT ANY ABNORMAL” function to stop the sweep when the collector current reaches to the compliance (250 µA).
5. The IV measurement automatically reads out the value at the last point of the sweep.
 - ✓ 5 ms step time and 2 ms aperture are used for fast sweep with 201 steps (wait time = 5 ms - 2 ms = 3 ms).

Figure 2-37 VGE(th) with constant VCE test setup used in the example.

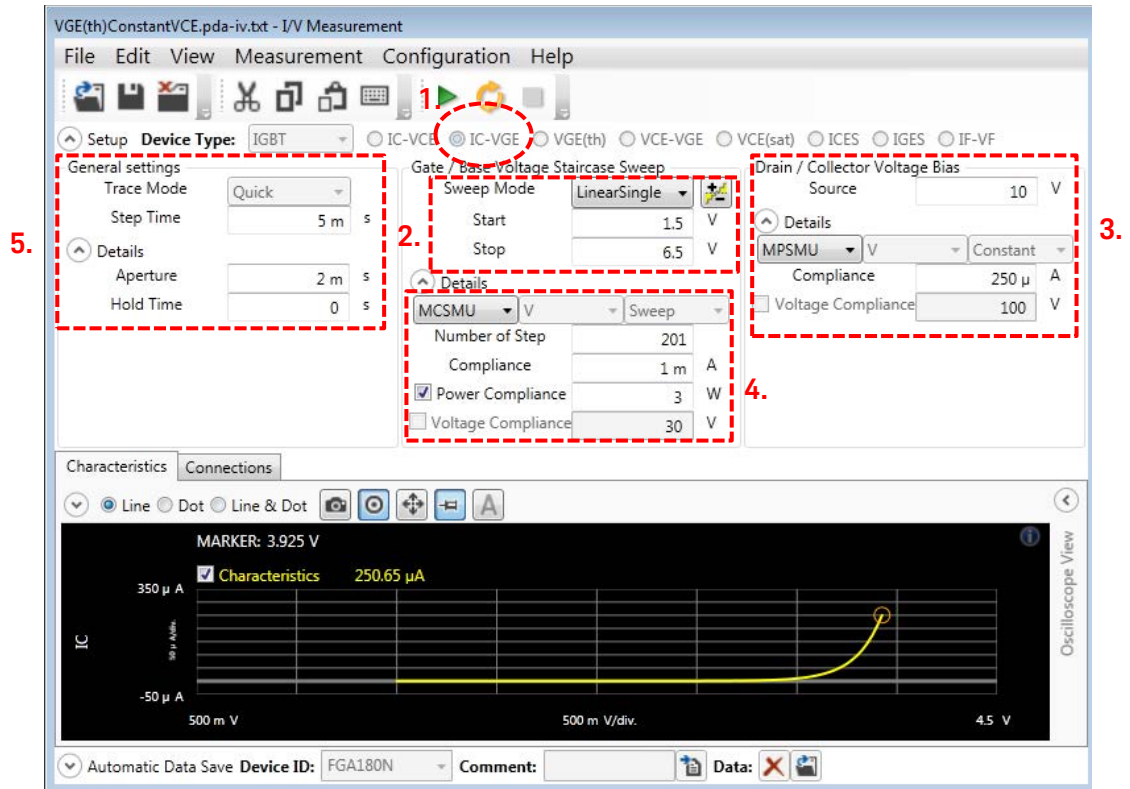

Note: Since the start and stop voltage of the gate voltage sweep are determined by the minimum and maximum limits defined in the datasheet mode, it is not allowed to remove them. To change/remove association between the minimum/maximum limit and the start/stop voltage, refer to “**Tips: How to change the symbol name and the description**” in the section headed “**Useful information for using the datasheet characterization mode**”.

Note: Do not remove the check form the power compliance in the gate/base voltage staircase sweep setting. Without enabling the power compliance, the sweep is not stopped even if the collector current reaches to the compliance and the VGE(th) read out from the sweep becomes erroneous (Figure 2-38).

Figure 2-38 Erroneous VGE(th) extraction by removing the check of the power compliance

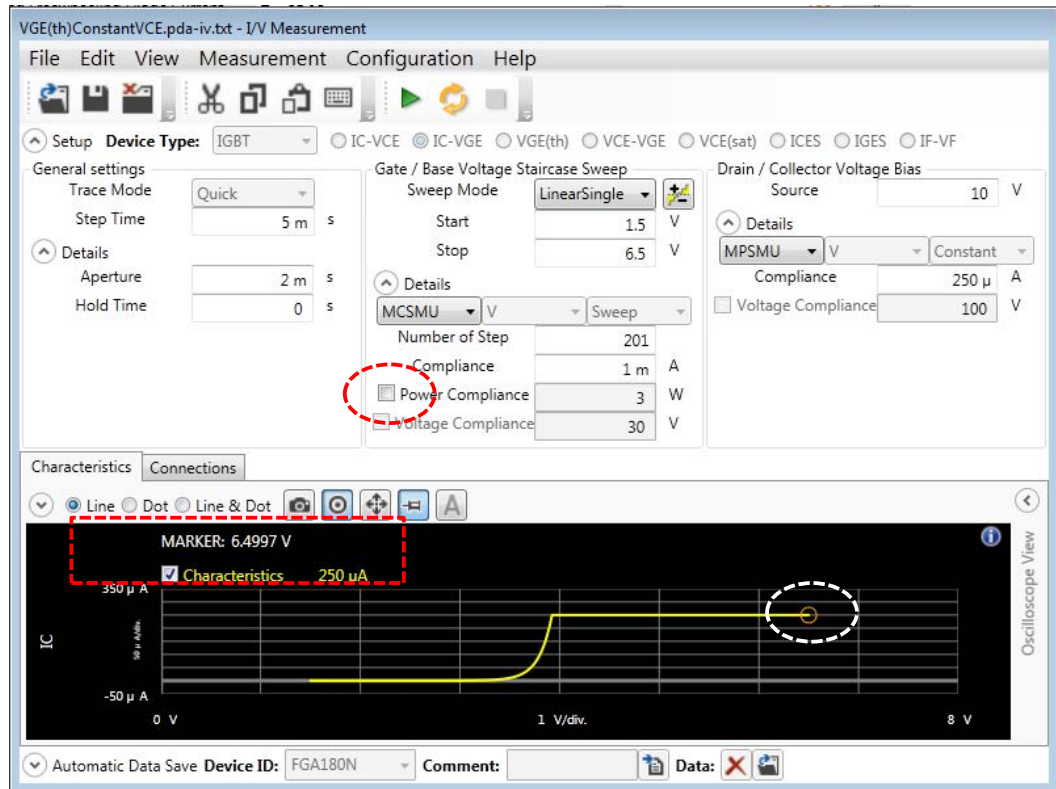

5.6 VCE(sat)

VCE(sat) is defined as a collector to emitter voltage when the specified collector current is flowing with the specified gate voltage. This parameter is typically used to estimate a conduction loss of IGBT.

How to set up the VCE(sat) measurement parameters

Typically, VCE(sat) is defined with two different collector current conditions as shown in Figure 2-39. In this demonstration, the VCE(sat) is defined at IC=40 A and 180 A.

In this case, duplicate the setting of the existing VCE(sat) and modify the test conditions by following the datasheet parameters.

Figure 2-39 VCE(sat) defined in two conditions, at IC = 40 A and 180 A.

On Characteristics							
VGE(th)	G-E Threshold Voltage	IC = 250uA, VCE = VGE	2.5	4	5.5	V	
VCE(sat)	Collector to Emitter Saturation Voltage	IC = 40A, VGE = 15V	-	1.1	1.4	V	
		IC = 180A, VGE = 15V,	-	1.68	-	V	
		IC = 180A, VGE = 15V,	-	-	-	-	V
		TC = 125°C	-	1.89	-	V	

VCE(sat) test conditions for IC=40 A

Follow the next steps to set up the first VCE(sat) test (Figure 2-40).

- ✓ Input the same test condition as in the datasheet (VGE = 15 V and IC = 40 A).
- ✓ Pulse width has to be chosen carefully not to damage the device by exceeding the safe operating area (SOA) limit of the device (See VCE-VGE measurement). For the device used in the example, 200 μs is enough).

Note: SOA limit using UHCU:

Refer to section “SOA and current load FET in Qg test” for SOA limitation using UHCU.

- ✓ Input the same maximum limit and typical value as in the datasheet.

Figure 2-40 VCE(sat) test conditions defined at IC=40 A.

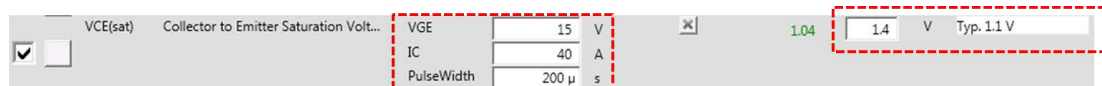

- ✓ Open the VCE(sat) I/V measurement setup panel. (Figure 2-41)

VCE(sat) I/V setups:

Following explains the VCE(sat) I/V measurement setup. Refer to the corresponding numbers shown in the figure.

1. VCE(sat) measurement template, which is based on the VCE-VGE measurement, is used. This setup outputs the specified pulsed constant collector current and measures the collector voltage.
2. The source value of the "Gate/Base Voltage Pulse Bias" parameter, "Start" value and "Pulse Width" of the "Drain/Collector Current Pulse Sweep" parameters are inherited from the test conditions defined in the datasheet mode.
3. The voltage compliance of the drain/collector bias is automatically determined by the maximum limit defined in the datasheet mode (+1 V).
4. In the VCE-VGE measurement, UHCU is used in current pulse mode (IPulse) which applies pulse with the specified current value.
5. The compliance voltage specified in the drain/collector bias setting is the maximum voltage limit of the voltage source in the UHCU.

Note: In the UHCU, the output current is determined by the setting voltage of the internal bias source (Vset), output resistor and resistance of the DUT. For details of UHCU setting tips, refer to section "The UHCU details and measurement ".

Figure 2-41 VCE(sat) test measurement setup for current pulse at IC=40 A.

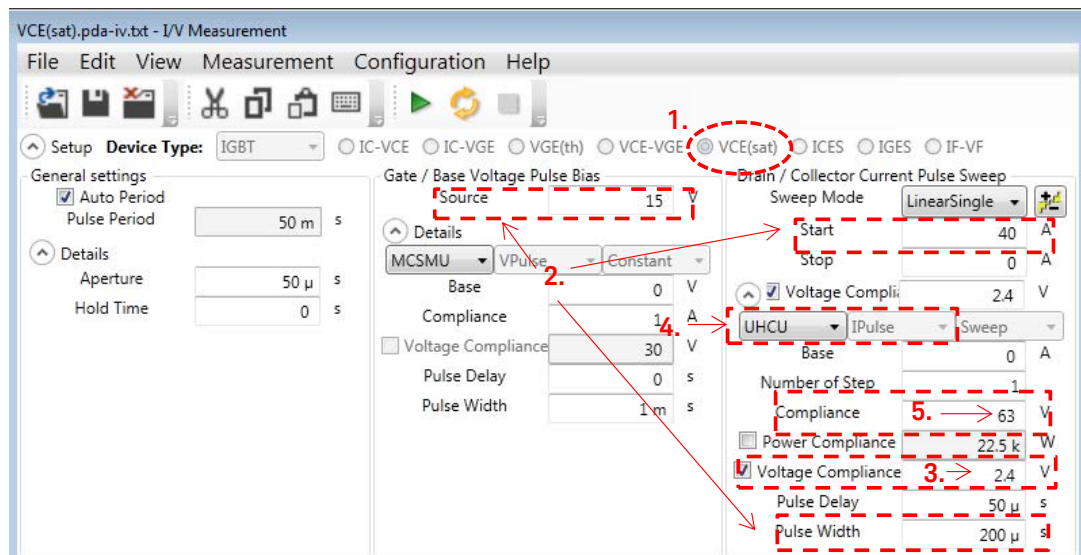

VCE(sat) pulse parameter setup:

Figure 2-42 shows the pulse setup parameters and the pulse timing.

6. There are following two parameters to set the pulse start timing.
 - 6a: Gate/Base Pulse Delay time.
 - 6b: Drain/Collector Pulse delay time.

Normally, the gate/base bias is set to start prior to the drain/collector bias to turn the DUT on before applying the drain/collector bias.

7. Pulse period setting
Pulse period is the time between the two measurement pulses. When “Auto Period” is enabled (refer to number 7a.), pulse period is automatically determined to make duty ratio maximum. “Auto Period” is typically used if there is no specific requirement in the timing.

Figure 2-42 VCE(sat) pulse test parameters and the pulse timing.

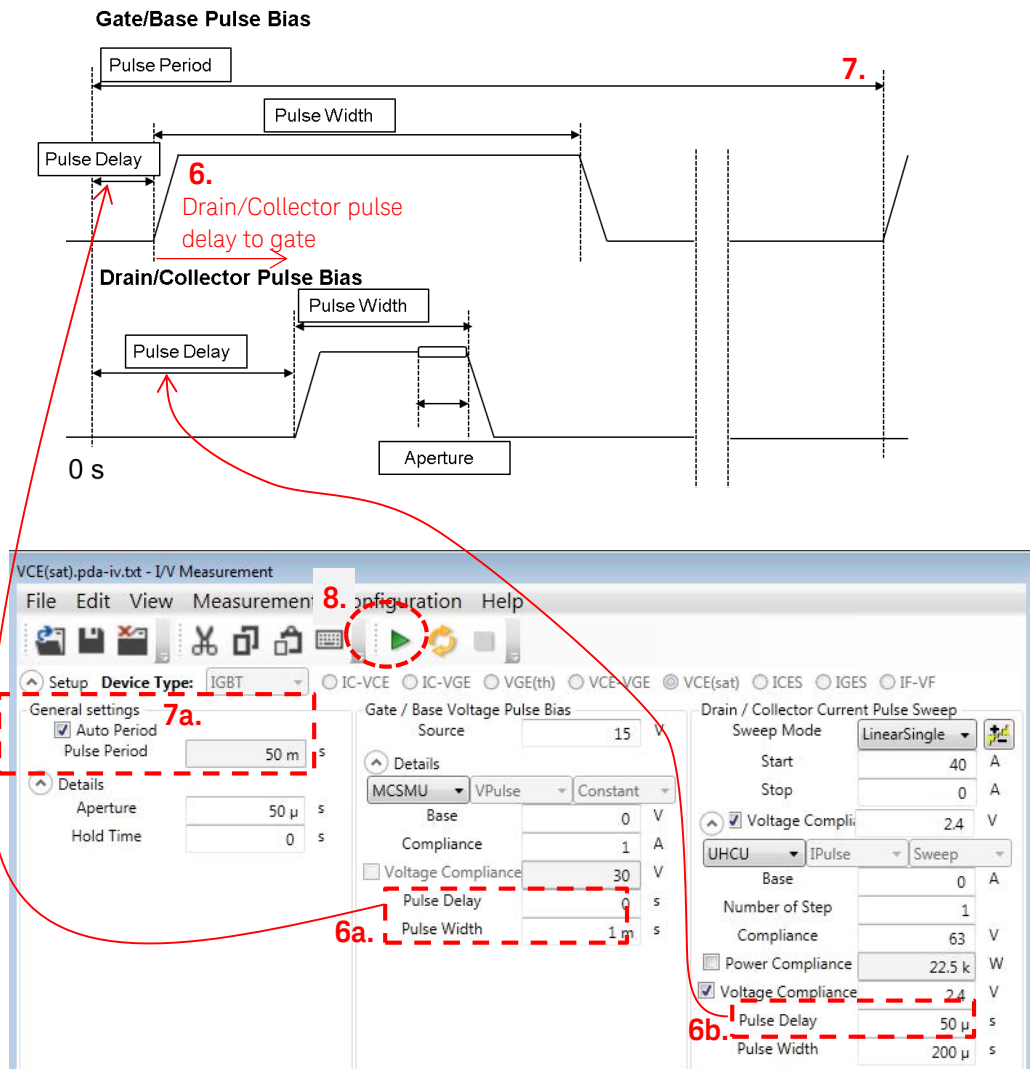

Note: For UHCU, 0.4 % is the maximum duty ratio for 500 A, and 0.1 % is the maximum duty ratio for 1500 A range. For HCSMU (B1506A-H21), the maximum duty ratio depends on the output current range (refer to the datasheet of B1506A).

Verification of the VCE(sat) at IC=40 A measurement setup

After the detail I/V measurement setup is finished, it is recommended to perform the verification of the measurement setup before going to set the second IC test condition. Follow the next steps by referring to the number in Figure 2-42.

8. Click the measure button, and the measurement result is displayed in the graph area.
- ✓ To save the test setup and the test result in the datasheet, save the setup by selecting “File”-->”Save”.



VCE(sat) test conditions for IC=180 A

After determining the first VCE(sat) test condition, the second VCE(sat) test condition at IC=180 A is set by duplicating the first setup to re-use the proven settings defined in the first VCE(Sat) IV measurement setup.

How to duplicate the existing test setup:

There are the following two ways to duplicate the existing test setup. Duplicate the existing VCE(sat) measurement setup from one of the following two ways.

Method 1: Duplicate Setup from the pop up menu:

- ✓ Right-click the parameter to be modified excepting the input parameters. (Refer to Figure 2-43.)
- ✓ Select the “Duplicate” from the pop-up menu.

Figure 2-43 Selecting "Duplicate" from the pop up menu.

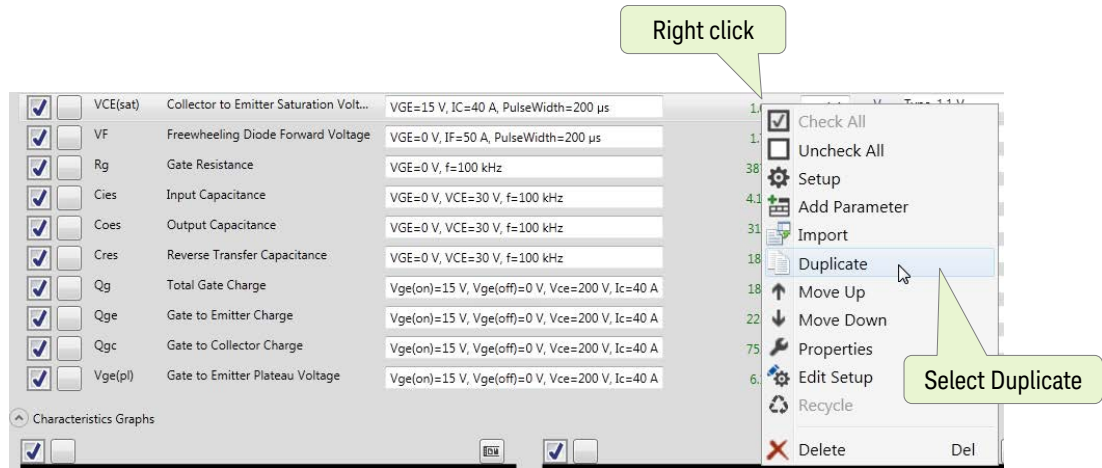

Method 2: Duplicate Setup from the ribbon menu of the Datasheet Characterization mode panel.

- ✓ Click the parameter to be modified excepting the input parameters, and select the measurement setup. . (Refer to Figure 2-44.)
- ✓ Click the "Duplicate" button in the ribbon menu.

Figure 2-44 Selecting "Duplicate" from the ribbon menu.

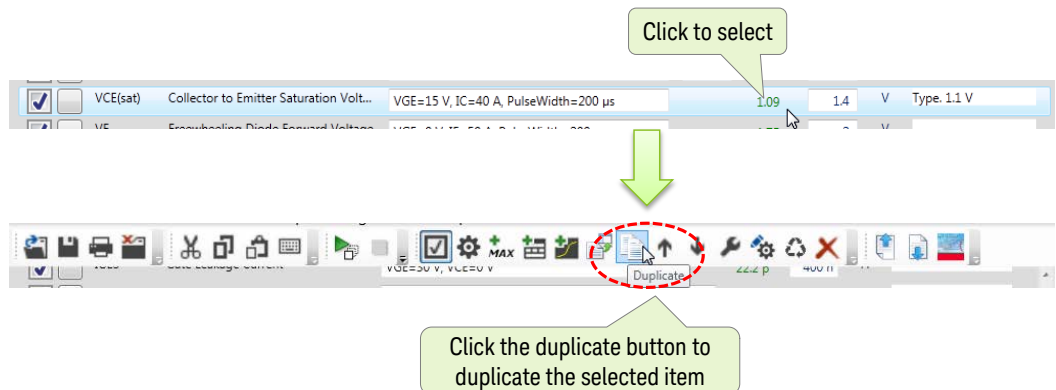

- ✓ The Copy of the setup for VCE(sat) is created as VCE(sat)_1. Then modify the test conditions of them based on the datasheet parameters. In the VCE(sat) example, enter IC=180 A as shown in the next figure.
- ✓

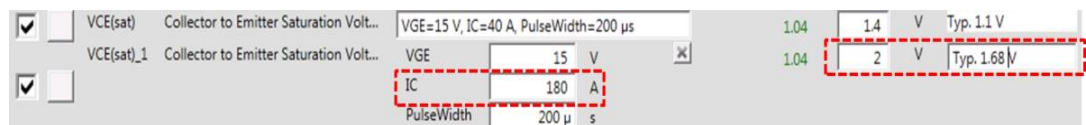

Note

In the datasheet, only the typical value is defined when IC is 180 A. However, the maximum limit is used to determine the voltage compliance in the detailed setup. This cannot be removed. So put a large enough value to pass the criteria as the maximum value and write the typical value in the Note field as a memo.

Verification of the VCE(sat) at IC=180 A measurement setup

- ✓ After the detail I/V measurement setup is finished, it is recommended to perform the verification of the measurement setup
- ✓ To save the test setup and the test result in the datasheet, save the setup by selecting "File"-->"Save".



5.6 Transconductance (gfs)

Note

The transconductance appears in the list of characteristics parameters only when using the B1506A-H20/H21 model. Since gfs is defined as dI_C/dV_{GE} with constant VCE at on-state, the HCSMU of B1506A-H20/H21 has to be used to measure it (B1506A-H50/51/H70/H71 have the UHCU instead of the HCSMU and it cannot keep constant VCE while outputting collector current due to voltage drop at its output resistor).

The DUT used in this example is the 2SK3475 high voltage MOS-FET which has following characteristics.

- ✓ VDSS: 1500 V
- ✓ VGSS: +/- 20 V
- ✓ IDPM: 4 A
- ✓ Rds(on): 10 Ω

gfs of the device is 14. S typical with VDS = 20 V and ID = 1 A (Figure 2-45).

Figure 2-45 gfs test conditions of 2SK3745



The following explains the gfs I/V measurement setup. Refer to the corresponding numbers shown in Figure 2-46.

1. The “IC-VGE” template of the IV measurement is used for this measurement.
2. In gfs measurement, gfs is used as the Y axis value instead of ID (Figure 2-47).
3. The gate voltage is swept from 0 V to 10 V in constant step (staircase sweep). It is necessary to define the start and stop value to make the drain current large enough to measure gfs. It should be larger than ID to measure gfs.
4. The HCSMU is used to apply drain bias in pulse mode. The source voltage is inherited from the VDS defined in the datasheet mode. The compliance current is also inherited from the ID to measure gfs from the datasheet.
5. To stop the IV sweep when the drain current reaches to 1 A defined as the current compliance, the power compliance is enabled.
6. The marker is automatically placed at the last point of the sweep to read out the gfs value at the specified current.

Figure 2-46 gfs test setup

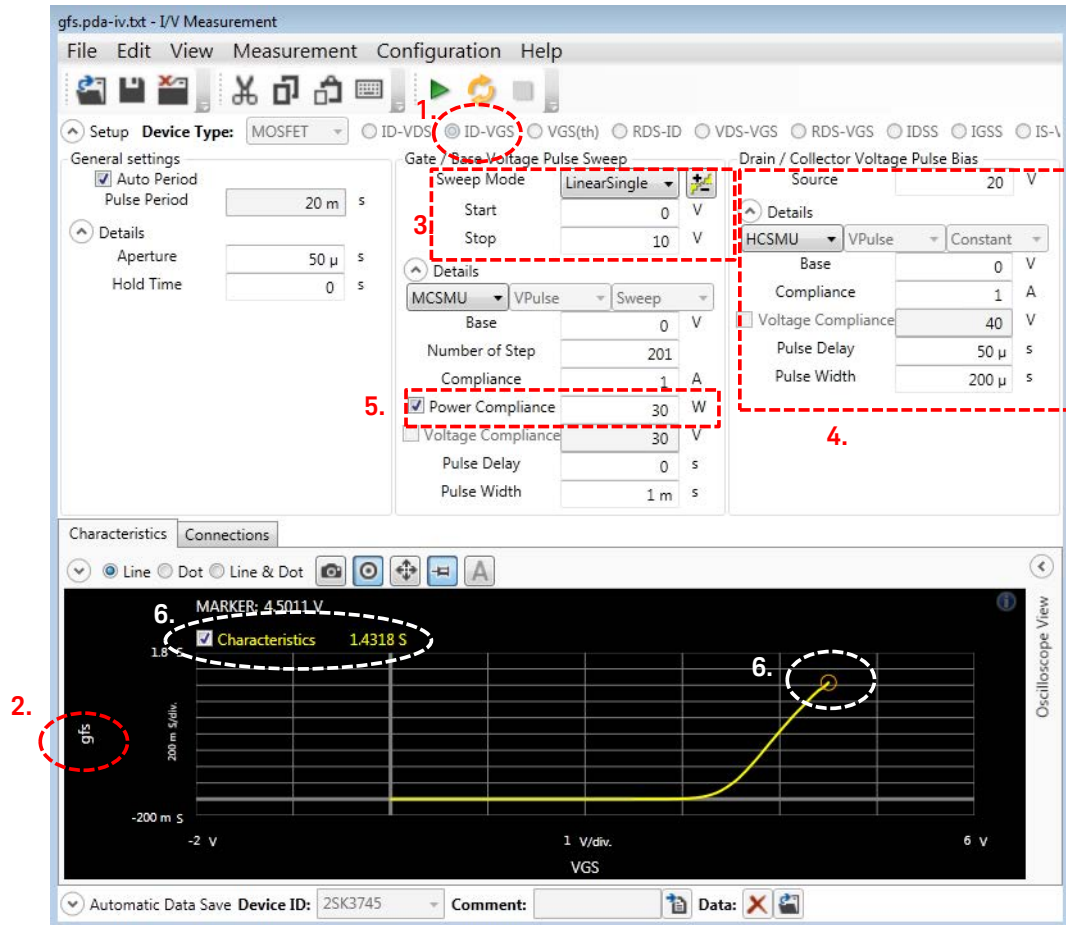
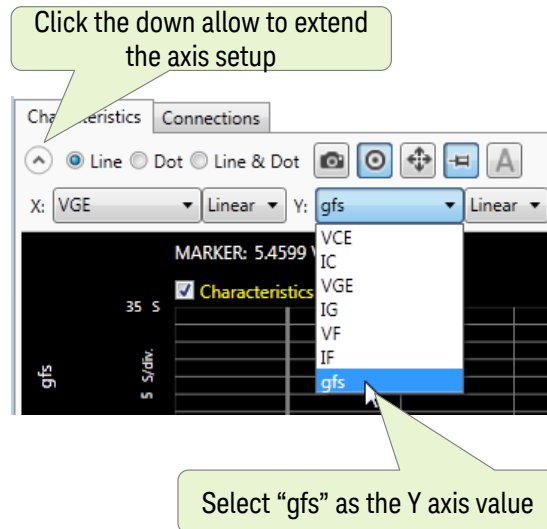

Figure 2-47 How to change the axis value



5.7 VF of freewheeling diode

VF is defined as forward voltage at the specified forward current of freewheeling diode which is built inside the IGBT package or built-in diode of the power MOSFET.

How to set up VF measurement parameters

Modify test conditions based on the conditions described in the datasheet. For example, here is a description of VFM in the datasheet. The diode forward voltage is defined at IF=20 A.

Symbol	Parameter	Test Conditions	Min.	Typ.	Max	Units
V _{FM}	Diode Forward Voltage	I _F = 20A T _C = 25°C T _C = 125°C	-	1.2	1.6	V

How to modify the test conditions, (refer to Figure 2-48)

- ✓ Click the parameter area to move into the edit mode.
- ✓ Modify the test conditions and ratings according to the datasheet.

1. Change the name of the symbol according to the datasheet, from "VF" to "VFM"
2. Input the same test condition as in the datasheet (V_{GE} = 0 V and I_F = 20 A).
3. Pulse width has to be chosen carefully not to damage the device by exceeding the SOA limit of the device (See V_{CE}-V_{GE} measurement).
(For the device used in this example, 200 μs is enough).
4. Input the same maximum limit and typical value as in the datasheet.

Figure 2-48 VFM test conditions.

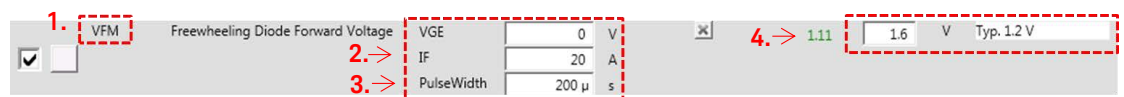

- ✓ Open the IF-VF I/V measurement setup panel. (Figure 2-49)

Following explains the IF-VF I/V measurement setup. Refer to the corresponding numbers shown in the figure.

5. IF-VF template of the IV measurement mode is used to measure VF.
6. This setup forces single step current pulse in the DUT and measures the voltage.
Since the polarity of VF is inverse of V_{CE} as shown in the next figure, the start current for VF measurement is to set in negative

polarity value of the specified IF.

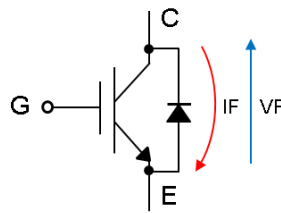

- The source value of gate/base voltage pulse bias, start value and pulse width of drain/collector current pulse sweep are inherited from the test condition defined as the datasheet setup.

Note: Normally, in the VF measurement, only the IF value is supposed to be modified. In some cases, depending on the device characteristics, the pulse width may have to be modified, too. In this case, the same pulse width as used in the IC-VCE measurement is basically used.

Figure 2-49 VFM test setup.

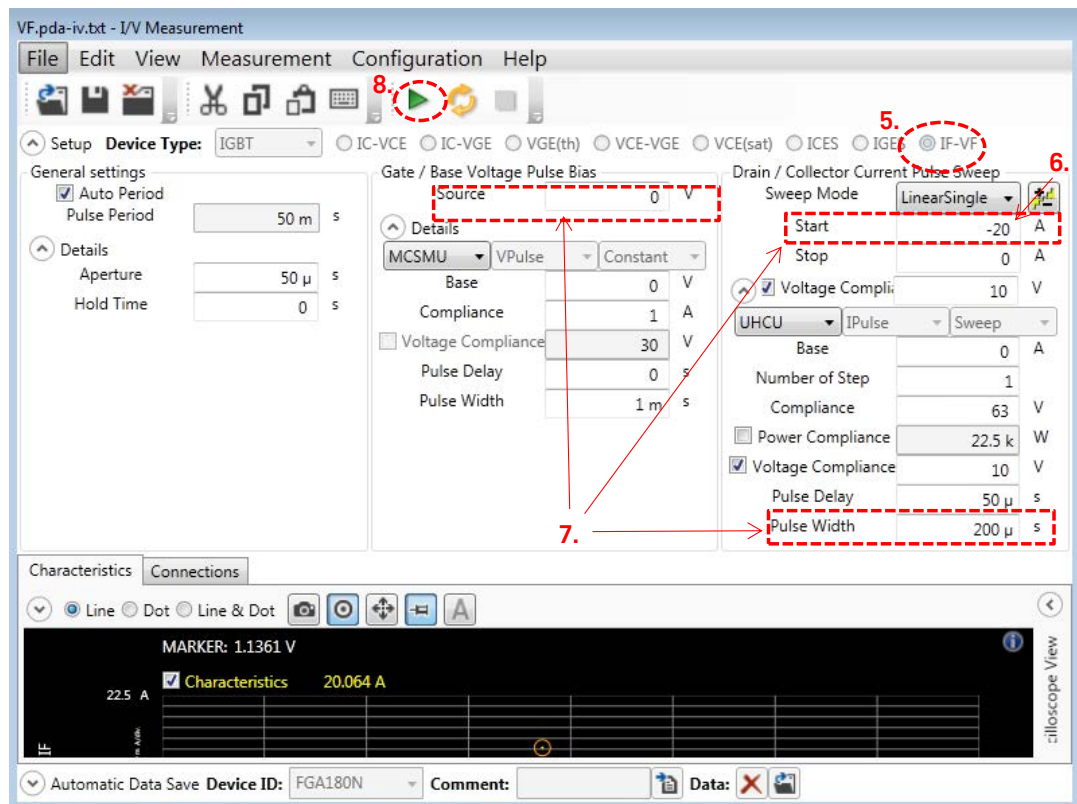

Verification of the VFM measurement setup

After the detail I/V measurement setup is finished, it is recommended to perform the verification of the measurement setup

8. Click the measure button, and the measurement result is displayed in the graph area.
- ✓ To save the test setup and the test result in the datasheet, save the setup by selecting “File”-->”Save”.

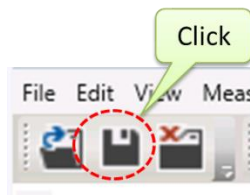

5.9 Other IV parameters

For information regarding measurements of other IV parameters such as $R_{ds(on)}$ of power MOSFET, please refer “Chapter 3. I/V Measurement”.

5.10 Internal gate resistance (R_g)

Internal gate resistance (R_g) is not listed in the datasheet of the FGA180N33ATD. In this section, the procedure to make a setup of R_g is referenced.

If you do need to delete the item, it can be deleted by right-clicking it, and selecting “Delete” from the pop-up menu (Figure 2-50), or by selecting the item and clicking the delete button in the ribbon menu (Figure 2-51).

Figure 2-50 Deleting the R_g by right clicking the test definition.

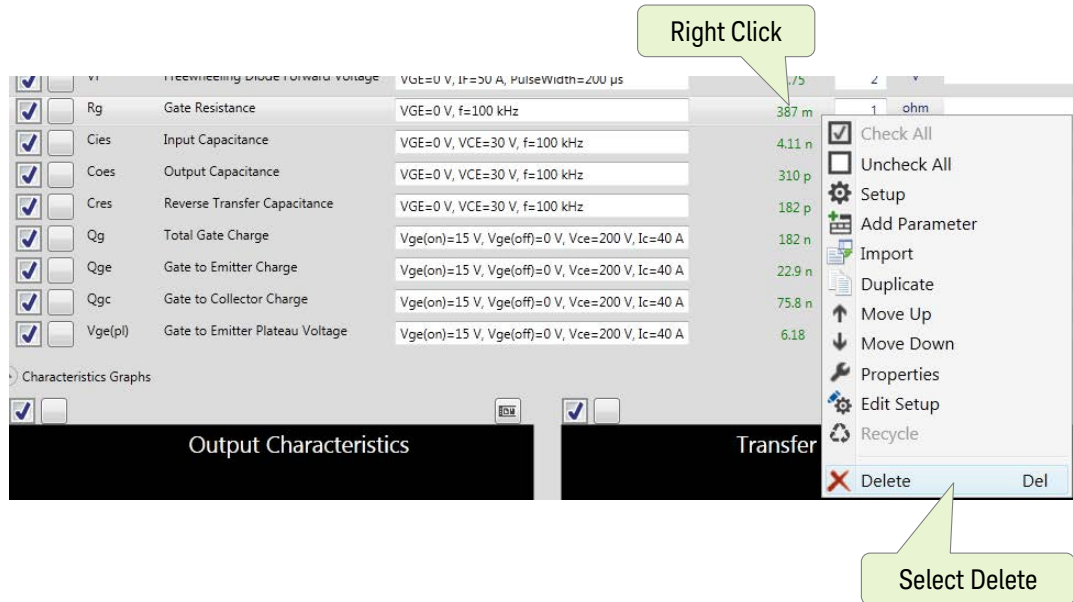
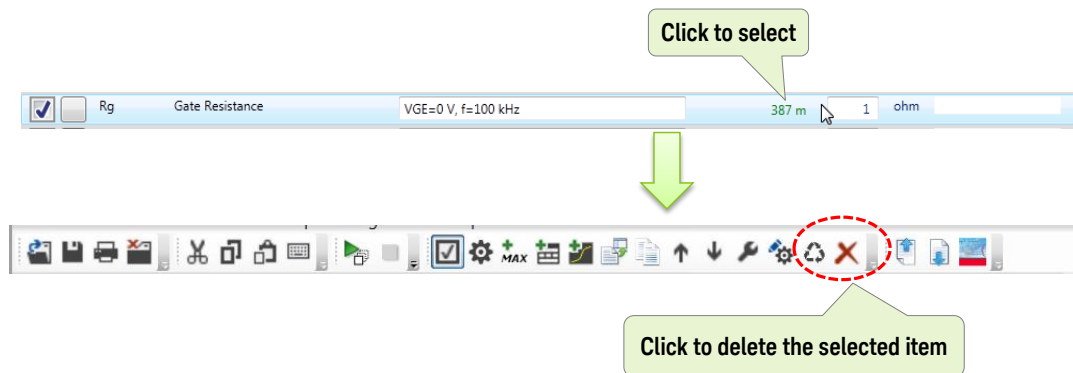

Figure 2-51 Deleting the R_g using the setup ribbon menu.



How to set up Rg measurement parameters

- ✓ Click the parameter area to move into the edit mode.
- ✓ Input the gate bias voltage and measurement frequency. Since Rg measurement uses the MFCMU in Cs-Rs mode, and extract Rg as series resistance to the gate capacitance, measurement frequency has to be specified (Figure 2-52)

Figure 2-52 Rg Test Conditions



- ✓ Open the Rg measurement setup panel and follow the next steps to set up the Rg measurement by referring to the corresponding number in Figure 2-53.
 1. In the background of the ICES measurement, “ICES” measurement template of the IV measurement mode is used.
 2. In the general setting, 100 kHz of measurement frequency is used. This value is inherited from the frequency defined in the datasheet mode.
 3. 30 mV of AC level is a value typically used for the capacitance measurement of a semiconductor device to maintain thermal equilibrium conditions.
 4. PLC mode is used for accurate measurement. If the measured Rg is noisy, increasing the number of NPLC (4, 8, 16 or more) is effective to reduce variations on measurements.

Figure 2-53 Rg measurement setup.

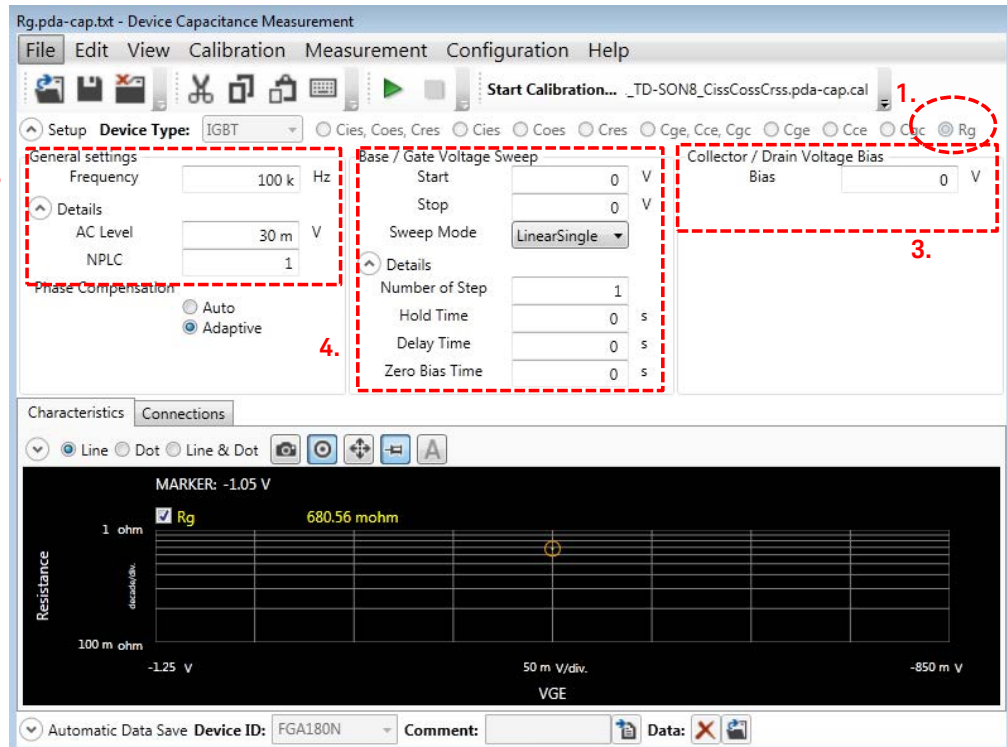

- ✓ As a default test condition, the collector terminal of the device is open (Figure 2-54). So, changing the collector voltage is not effective.
- ✓ The single step of 0 V is set as the Start voltage (only the first step with the start voltage is measured). This value is inherited from the VGE defined in the datasheet mode.

Figure 2-54 A simplified schematic circuit diagram of Rg measurement

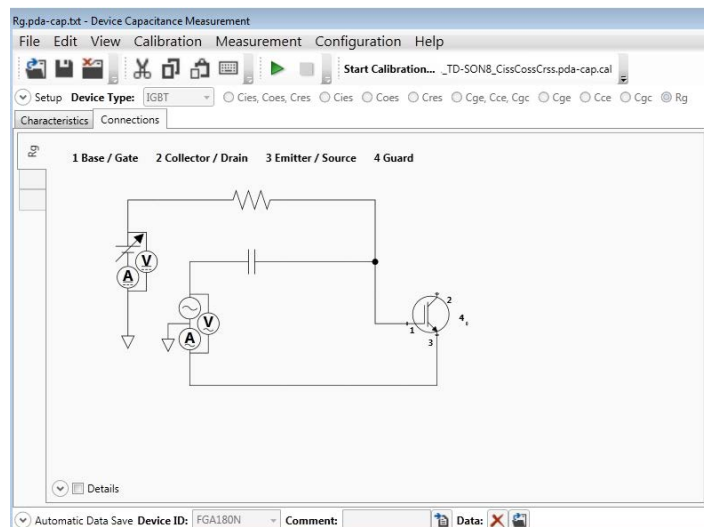

Note: **R_g measurement circuit**

Typically, R_g is measured as a series resistance when measuring C_{gs} of MOS-FET with drain open condition as shown in Figure 2-55(a).

Figure 2-55 R_g measurement circuit for Power MOSFET

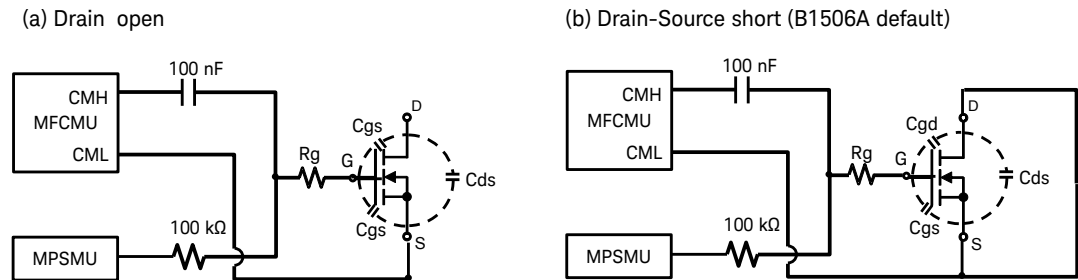

The default setup of the Easy Test Navigator software for the R_g measurement template for MOSFET is the short connection of the drain and the source as shown in Figure 2-55(b).

The connection of the drain and the source short is used to minimize the error associated with the "Device capacitance switch". Therefore, it is recommended that you use the default drain-source short condition unless there is a particular reason for not doing so.

To change the drain and source connection for R_g measurement, refer to section **"How to change the connections of R_g measurement"** in the section headed **"Useful information for using the datasheet characterization mode"** at the end of this chapter.

Note: **R_g measurement of IGBT with VCE ≠ 0 V**

Occasionally, in the datasheet of IGBT, sometimes, R_g is defined with VCE biased condition on to the collector. In this case, the same connection as in the C_{ies} measurement can be used (Figure 2-56).

Figure 2-56

R_g Measurement circuit for IGBT with collector biased condition

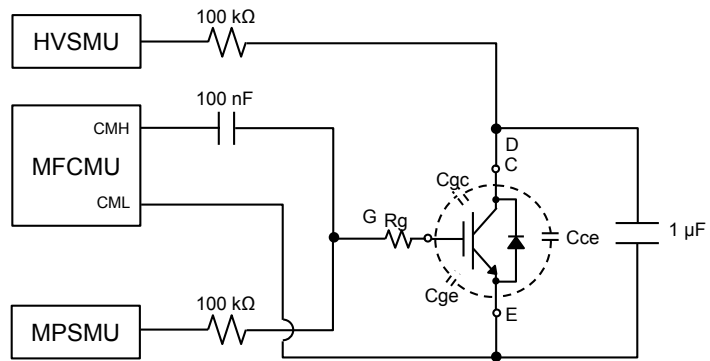

How to apply the bias voltage to the collector:

To apply a bias voltage as show in Figure 2-56, refer to section “**How to change the connections of R_g measurement**” in the section headed “**Useful information for using the datasheet characterization mode**” at the end of this chapter.

5.11 Capacitance (Cies, Coes, Cres)

Capacitance characterization in the datasheet mode supports the following parameters.

IGBT: Cies, Coes and Cres

MOSFET: Ciss, Coss and Crss

How to set up capacitance measurement parameters

Capacitance measurement is quite simple.

- ✓ Specify the same test conditions as in the datasheet works fine for a relatively small device.

Note:

For large capacitance measurement or enhancing the measurement accuracy, refer to section “Capacitance Measurement Tips” in the section headed "Useful information for using the datasheet characterization mode" at the end of this chapter.

How to modify the test conditions, (Figure 2-57.)

You can modify the test conditions based on the conditions described in the datasheet. For example, here is a description of the dynamic characteristics of the capacitor components in the datasheet.

Dynamic Characteristics						
Symbol	Parameter	Test Conditions	Min.	Typ.	Max.	Unit
Cies	Input Capacitance	VCE = 30V, VGE = 0V, f = 1MHz	-	3880	-	pF
Coes	Output Capacitance		-	305	-	pF
Cres	Reverse Transfer Capacitance		-	180	-	pF

Set the test conditions for each parameter by the following steps by referring to the number shown in the figure.

1. Enter the test conditions for VGE, VCE and measurement frequency. When using the B1506A, due to an additional error of its device capacitance switch, 100 kHz measurement frequency is recommended.
2. Enter the maximum test limits if those are defined in the datasheet. If not, it is possible to remove the maximum or the minimum value by leaving them blank.
3. Entering a typical value is recommended in the case of no max. value is described in the datasheet.

Figure 2-57 Capacitance test conditions.

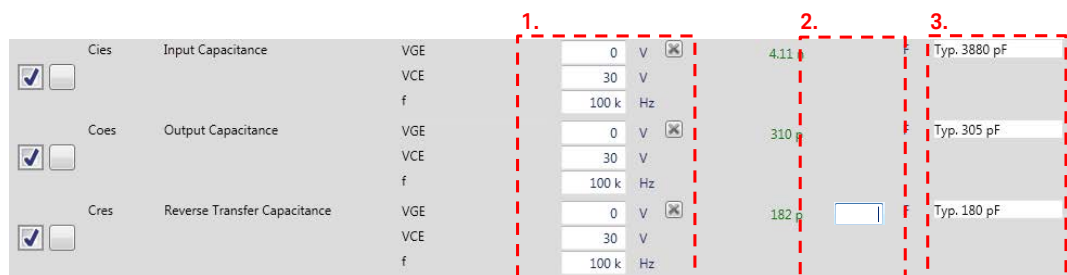

The detail of the Capacitance measurement setups

To measure the capacitance parameters, the capacitance measurement mode is used.

4. For a Cies measurement, the “Cies” template of the capacitance measurement mode is used as shown in Figure 2 58. Coes and Cres are the same, and not showing in the setup windows.
5. Measurement frequency, VGE and VCE to measure capacitance are inherited from the test conditions defined as the datasheet setup.
6. Start and stop voltage are inherited from the test condition as the datasheet setup. Single point measurement is defined by specifying “1” as the number of the step.

There is no need to change the measurement parameters in the capacitance measurement setups.

The available options are AC level (measurement signal level) and N PLC (number of power line cycle) measurement time.

Hold time and delay time to wait charging of DC blocking / AC short capacitor in the device capacitance switch are added internally to the specified values

Figure 2-58 Cies Capacitance measurement example.

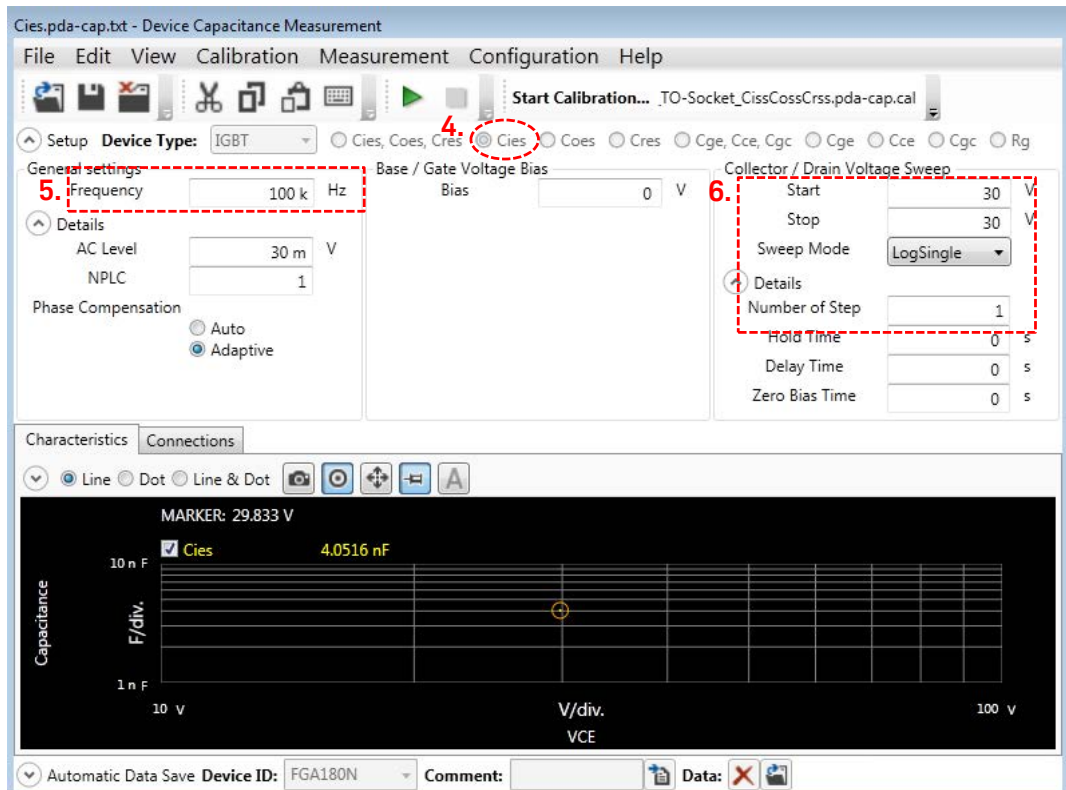

Note: In the capacitance measurement mode, connection of bias-T, AC block resistor and AC short capacitance are automatically changed to measure each capacitance parameter respectively.

Reference: Refer to the section "**Capacitance measurement techniques**" in the section headed "**Useful information for using the datasheet characterization mode**" at the end of this chapter for details of the measurement circuitry including the AC short capacitor.

Verification of the Cies capacitance measurement setups

After the capacitance measurement setup is finished, it is recommended to perform the verification of the measurement setup.

- ✓ Click the measure button, and the measurement result is displayed in the graph area.
- ✓ To save the test setup and the test result in the datasheet, save the setup by selecting "File"-->"Save".



Verification of the Coes, Cres capacitance measurement setups

Repeat the verification for Coes and Cres as in the Cies setup.

5.12 Gate charge (Qg, Qge, Qgc)

A gate charge (Qg) measurement measures a charge injected into the gate terminal to raise the gate voltage with a limited gate current and to turn the device from off state to on condition.

Reference: Refer to section "Gate charge measurement basics" for details of the measurement circuitry.

How to set up gate charge measurement parameters

Modify the test conditions based on the conditions described in the datasheet as shown in Figure 2-59. For example, here is a description of Qg characteristics in the datasheet.

Switching Characteristics						
Symbol	Parameter	Test Conditions	Min.	Typ.	Max.	Unit
Qg	Total Gate Charge	VCE = 200V, IC = 40A, VGE = 15V	-	169	-	nC
Qge	Gate to Emitter Charge		-	22	-	nC
Qgc	Gate to Collector Charge		-	69	-	nC

In the case if the gate charge parameters are defined with constant collector current (or drain current) as in the example case, the settings of Qg measurements are straightforward. Simply enter the specified parameters to the test conditions field as in the datasheet.

Set the test conditions for each parameter by following steps by referring to the number shown in the figure.

1. Enter the test conditions for Vg(on), Vg(off), Vce and Ic for the parameters Qg, Qge and Qgc.
2. Enter the maximum test limits. Although there is no maximum specification in the datasheet, it is recommended to enter some larger value for pass/fail judgment of the software. If the max. value is smaller than the measurement value, then the measured value is shown in red color as shown in the bottom of the figure by the red arrow.
3. Entering a typical value is recommended in the case of no max. value in the datasheet.

Figure 2-59 Qg test condition setup.

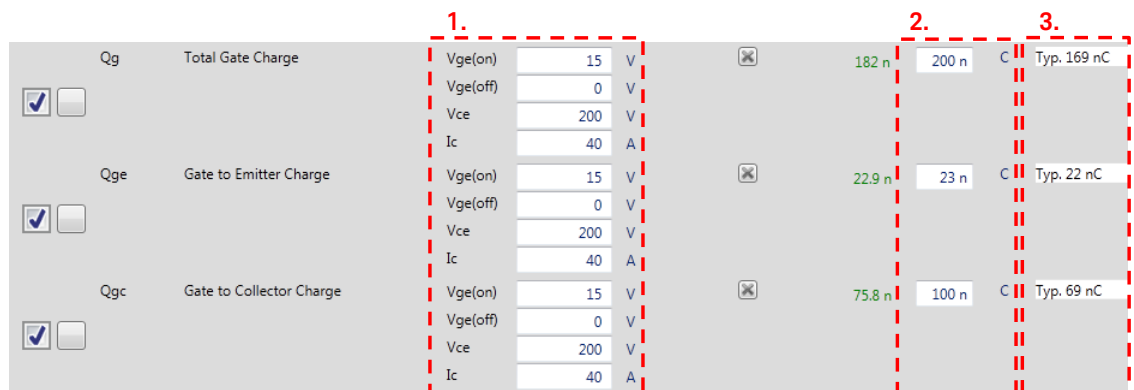

Note When the load resistance is specified to measure Q_g in the datasheet, it is recommended to convert the resistance value to the current value using the conversion as $(I = V_{CE}/\text{Resistance value})$. This is because the Q_g measurement of the B1506A uses different methodology (i.e. constant current load instead of resistance). For more details of Q_g settings, refer to section "**Chapter 5 Gate charge measurement**".

Tips For $V_{ge}(\text{off})$ (or $V_{gs}(\text{off})$), normally 0 V is used as in the Q_g curve in the graph section of the datasheet. (Figure 2-60)

Figure 2-60 Gate charge characteristics example.

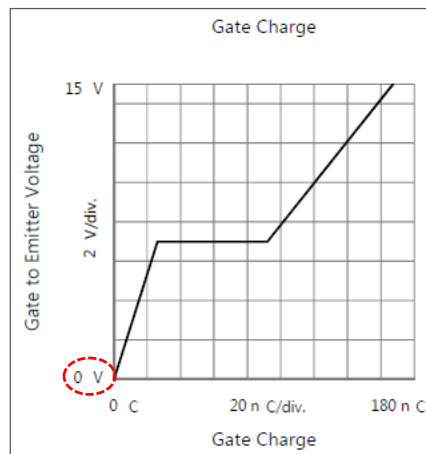

How to choose a current load FET

Generally, the same device as the DUT can be used as a current load FET.

But, since the switching time during the Q_g measurement using B1506A is relatively long compared to conventional Q_g measurement equipment, there is a potential risk of damaging the current load FET if the test condition exceeds the safe operating area (SOA) of the current load FET.

Tips: Since the current load FET is used at its saturation area (constant drain current area), there is a potential risk of device breakdown due to its SOA limit. Therefore, it is recommended to choose a device with wider SOA than the DUT, if possible. Refer to section "**SOA and current load FET in Q_g test**" for a more detailed explanation.

In the B1506A's demonstration purpose, IXTX200N10L2 N-Channel MOS-FET is used as a standard current load.

It has the following characteristics.

- ✓ VDSS: 100 V
- ✓ IDM(pulse): 500 A
- ✓ RDS(on): 11 mΩ
- ✓ SOA limit: If the maximum 60 V from UHCU is consumed at the device, it can be used as a current load up to 200 A.

Qg setup

To measure Qg in the datasheet, the gate charge measurement mode of Easy Test Navigator is used.

- ✓ Open the gate charge measurement setup panel. (Figure 2-61)
The following parameters come from the test condition setup from the datasheet setup, and they are inherited from the test conditions defined in the datasheet setup. (Refer to the number in the figure for corresponding items.)
1. $V_{ds(off)} = V_{ce(off)}$
 2. $I_{d(on)} = I_{c(on)}$
 3. $V_{gs(off)} = V_{ge(off)}$
 4. $V_{gs(on)} = V_{ge(on)}$
 5. Input the V_{th} from the $V_{GE(th)}$ ($V_{GS(th)}$ for MOSFET) to the $V_{gs(th)}$ in the definition area of Qg curve.

Figure 2-61 Gate charge measurement window.

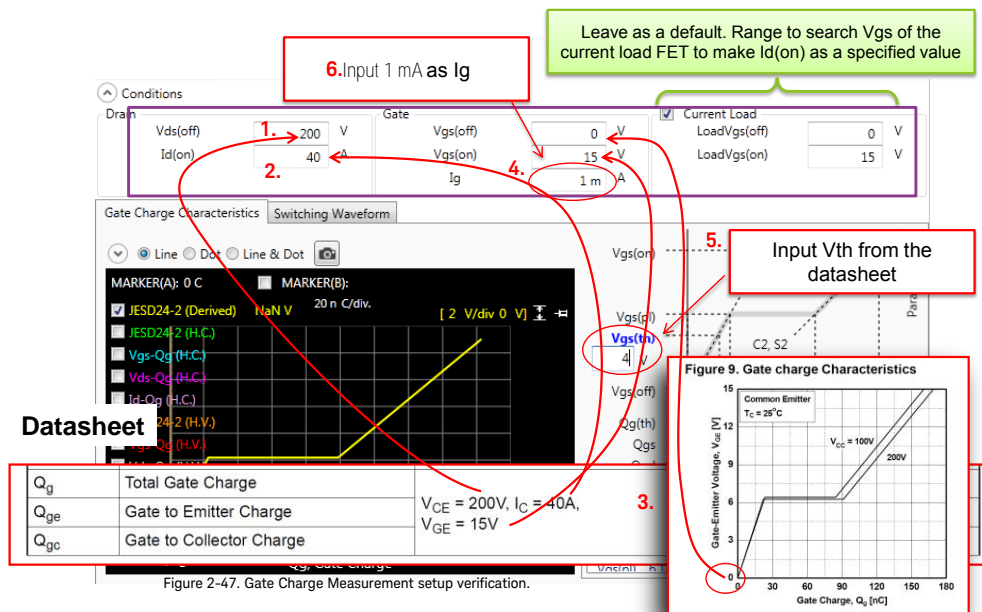

6. Gate current (I_g) is not usually picked up from the datasheet. The I_g parameter used in the B1506A is determined by the following steps.

Calculate the required charges (R_q) to drive the gate using the following formula:

$$- R_q = (Q_g \text{ (from the datasheet)} / V_{GE} \text{ (Test condition)}) + 1.6 \text{ nF} \\ \times ((V_{GE} \text{ (Test condition)} + 3.5) \times (1.5 \sim 2))$$

Using the example parameters, R_q can be calculated as;

$$- R_q = (169 \text{ (nC)} / 15 \text{ (V)} + 1.6 \text{ (nF)}) \times (15 \text{ (V)} + 3.5) \times (1.5 \sim 2)^* \\ = 238 \times (1.5 \sim 2) \text{ nC} \\ = 357 \sim 476 \text{ nC.}$$

Note: This charge must be forced to the gate within one gate pulse width period.

(1.5 ~ 2) factor is multiplied to compensate the actual current from MCSMU. The MCSMU current in a short transient period is typically lower than the set value, and adding this factor is recommended.

- a) Calculate the minimum I_g required to charge R_q in default 400 μs gate pulse.

$$- \text{Min. } I_g = R_q / 400 \mu\text{s}$$

Using the required charge in the previous step is calculated as,

$$- \text{Min. } I_g = (357 \sim 476) \text{ nC} / 400 \mu\text{s} = 0.89 \text{ mA} \sim 1.19 \text{ mA}$$

- b) Determination of I_g used in the Q_g measurement.

Using the min I_g calculated in the previous step, 1 mA is used in the example Q_g measurement.

Note: For more details of the I_g determination background, refer to section "**How to determine I_g to measure gate charge**" section for a more detailed explanation.

Note: Some datasheet describes I_g for Q_g measurement, but this I_g is to drive the gate in a real switching speed. For B1506A, the I_g cannot be used because the actual switching speed is too fast for B1506A.

Verification of the Qg measurement setup

After the detail Qg measurement setup is finished, it is recommended to perform the verification of the Qg measurement setup. (Refer to Figure 2-62)

7. Click the measure button, and the measurement result is displayed in the graph area.
8. To save the setup and the test result in the datasheet, save the setup by selecting “File”-->”Save”, or click save button in the ribbon menu.

Figure 2-62 Qg measurement setup verification.

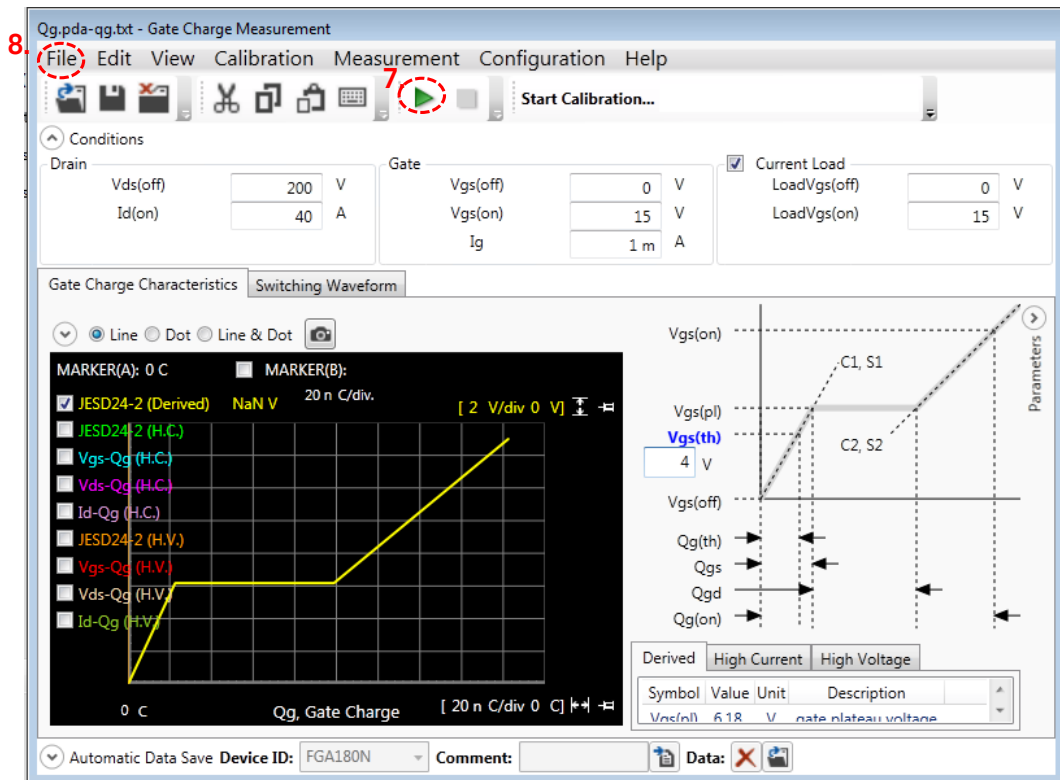

Qge, Qgc setup

Repeat the steps shown in Qg setup for Qge and Qgc setups and the verification of the setups.

How to delete the gate plateau voltage $V_{ge(pl)}$

Since there is no definition of the gate plateau voltage, the $V_{ge(pl)}$ in the datasheet of the sample device, this test can be removed.

Delete the setup of the $V_{ge(pl)}$ by right-clicking it and select “Delete” from the pop-up menu (Figure 2-63), or select the item and click the delete button in the ribbon menu (Figure 2-64).

Figure 2-63 Deleting the $V_{ge(pl)}$ parameter from the datasheet using popup menu.



Figure 2-64 Deleting the $V_{ge(pl)}$ parameter from the datasheet using the ribbon menu.

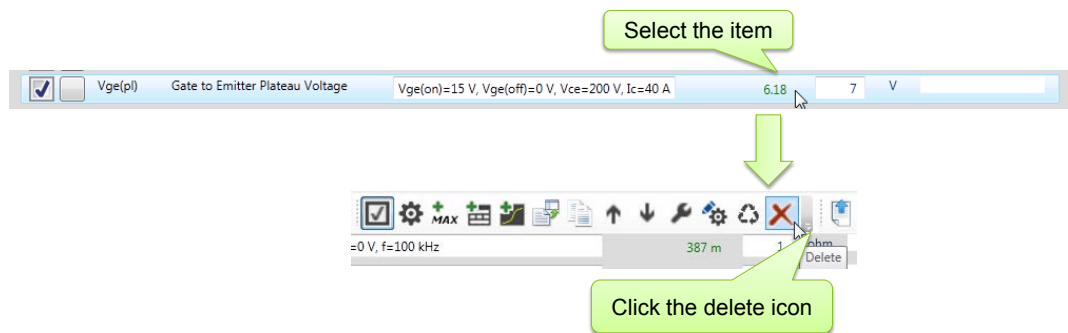

Step 6

Creating a setup for characteristics graphs section

This step demonstrates how to create each measurement setup of the graph characterization for the following devices.

6.1 IC-VCE characteristics

6.2 IC-VGE characteristics

6.3 VCE-VGE characteristics

6.4 VF (Freewheel diode) characteristics

6.5 Other IV characteristics

6.6 CV characteristics

6.7 Gate charge characteristics

Characteristics Graphs section locates the bottom section of the Datasheet Characterization panel. To set up the measurement and graphics display parameters, place the mouse cursor on top of the graphics or the graph parameters, then click the item to edit.

6.1 IC-VCE characteristics

How to set up IC-VCE graphics measurement parameters

FGA180N33ATD measurement condition of IC-VCE output characteristics:

- ✓ IC: 0 - 200 A
- ✓ VGE: 0 - 6 V
- ✓ VGE: 6, 7, 8, 9, 10, 12, 15, 20 V

Follow the next steps to set up the parameters.

1. Graphic scale setup

Modify ranges of the vertical axis and the horizontal axis of the graphics (refer to Figure 2-65) the same way as in the datasheet.

Figure 2-65

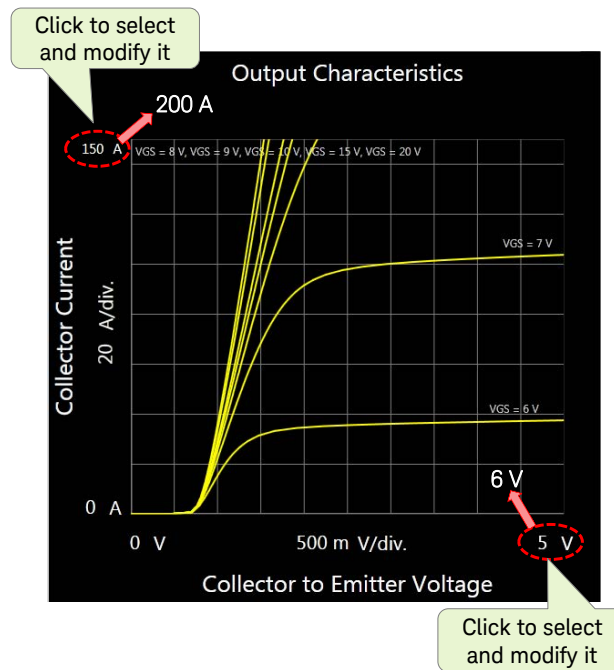

- ✓ Set collector current: 0 - 200 A
- ✓ Set collector voltage: 0 - 6 V
- ✓

2. Gate voltage steps

Modify the gate voltage steps by opening the setup of the IC-VCE measurement by referring to Figure 2-66.

- ✓ Open the setup window from one of the following two ways:
 - a) Right click the item and select "Setup" from the pop-up list.
or
 - b) Select the item and click the setup button in the ribbon menu.

Figure 2-66 Opening the IC-VCE setup.

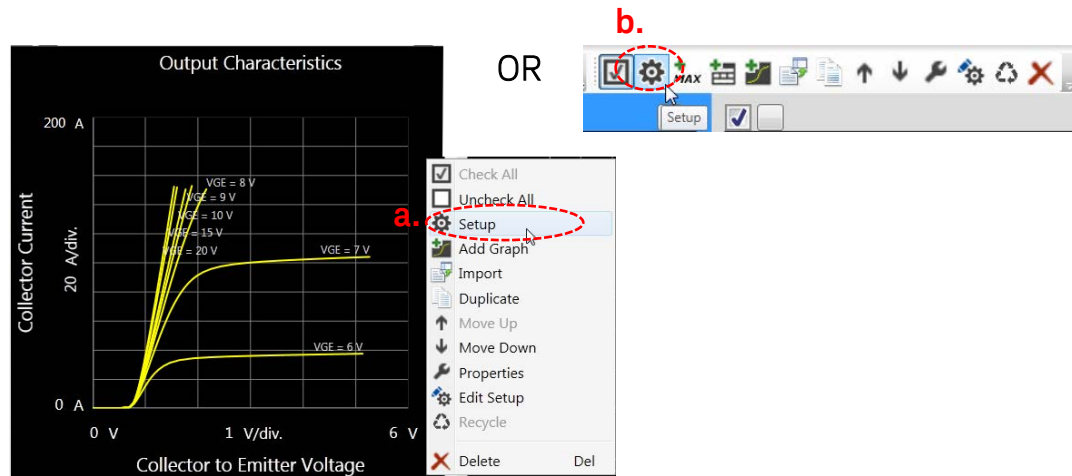

- ✓ The IC-VCE setup window opens as shown in Figure 2-67.
- ✓ Click on the list numbers of the step list to expand the number list to edit mode. (Figure 2-67(a))
- ✓ Modify the list of the gate sweep voltage same as the datasheet (6 V, 7 V, 8 V, 9 V, 10 V, 12 V, 15V, 20 V).

Figure 2-68 shows how the gate step voltage can be changed. Follow the next steps by referring to the number in the figure.

There are already 6, 7, 8, 9, 10, 15, 20 V in the list, and the missing 12 V is added.

1. Click 15 V
2. Click Insert icon.
3. 0 V is inserted.
4. Change the inserted 0 V to 12 V.

- ✓ Modify the stop voltage of the collector voltage sweep to 30 V to cover the whole area of the chart as shown in Figure 2-67(b).

The stop voltage is determined by using the following formula,
 $V_{set} > (max. V_{out}) + (current\ compliance) \times R_{out}$,
 and it is,

$$6\text{ V} + 200\text{ A} \times 120\text{ m}\Omega = 30\text{ V}$$

where 120 mΩ is the value of the output resistance at 500 A range of Ultra High Current Unit (UHCU).

Refer to section "How to set the UHCU's V/I parameters for the VCE(sat)" for the detailed explanation of the UHCU operation.

Figure 2-67 IC-VCE setup window.

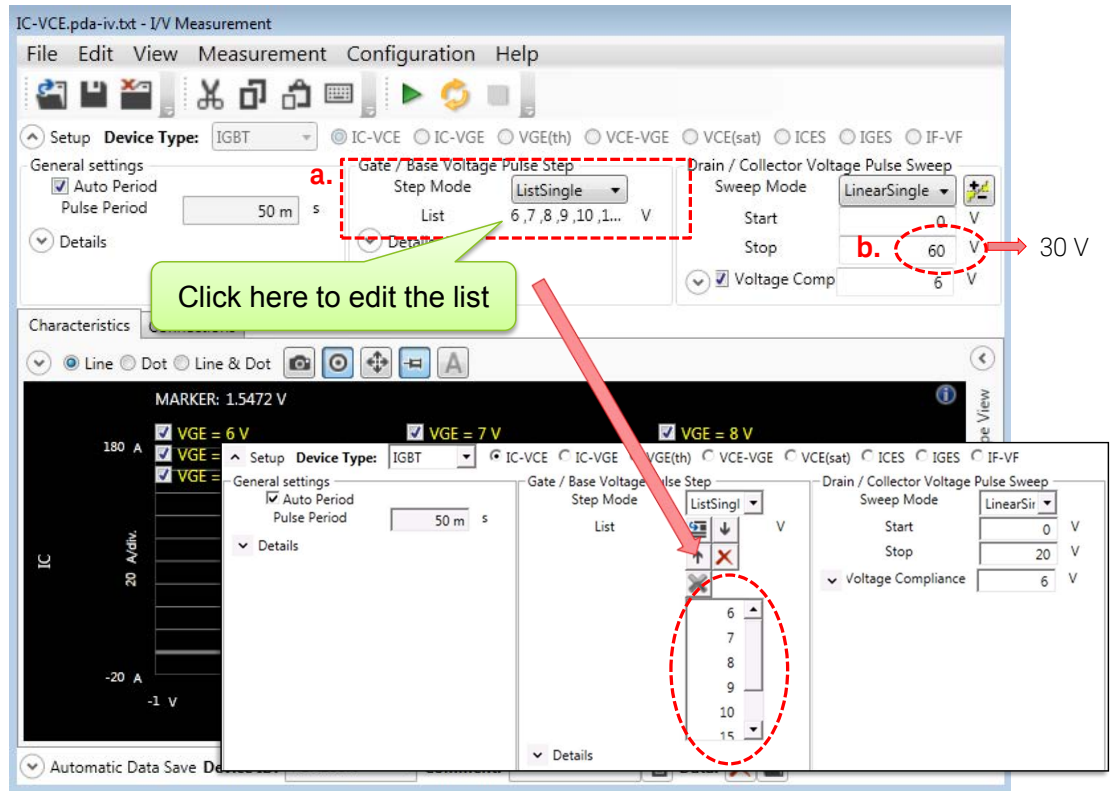
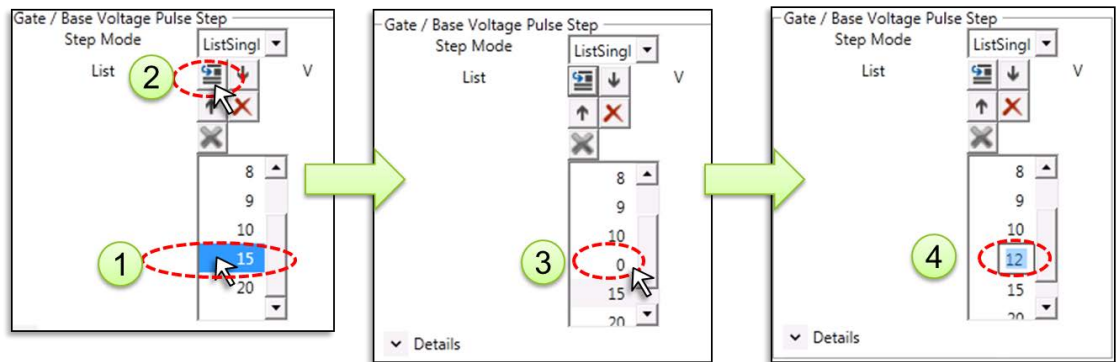

Figure 2-68 Gate step voltage modification.



Verification of the IC-VCE measurement setup

After the detail measurement setup is finished, it is recommended to perform the verification of the measurement setup

- ✓ Click the "Measure" button of the IV measurement setup to confirm the settings. (Refer to Figure 2-69(a).)

Figure 2-69 IC-VCE measurement result

a) Ic-VCE setup and the output.

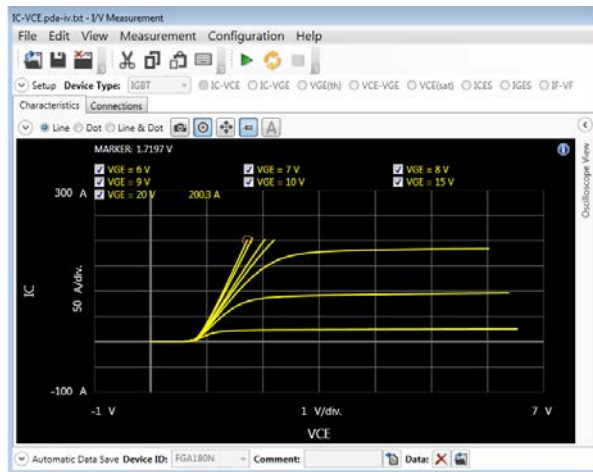

b) Updated Datasheet graph.

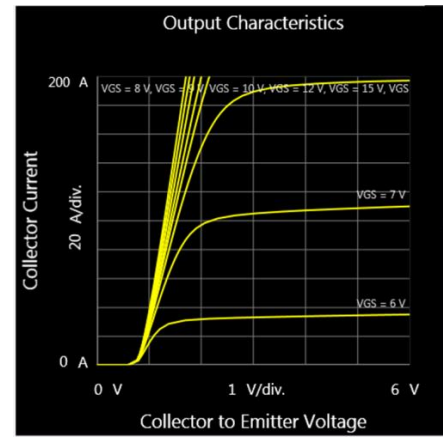

Note:

At the upper right corner, sometimes, an exclamation mark appears after finishing the measurement (Figure 2-70). It indicates a certain abnormal status is reported during the measurement. In the case of IC-VCE measurement, since measurement at voltage or current exceeds the specified voltage and current compliances are skipped, the exclamation mark appears. Details of the reported status can be checked by clicking the mark.

Figure 2-70 Notification of measurement status

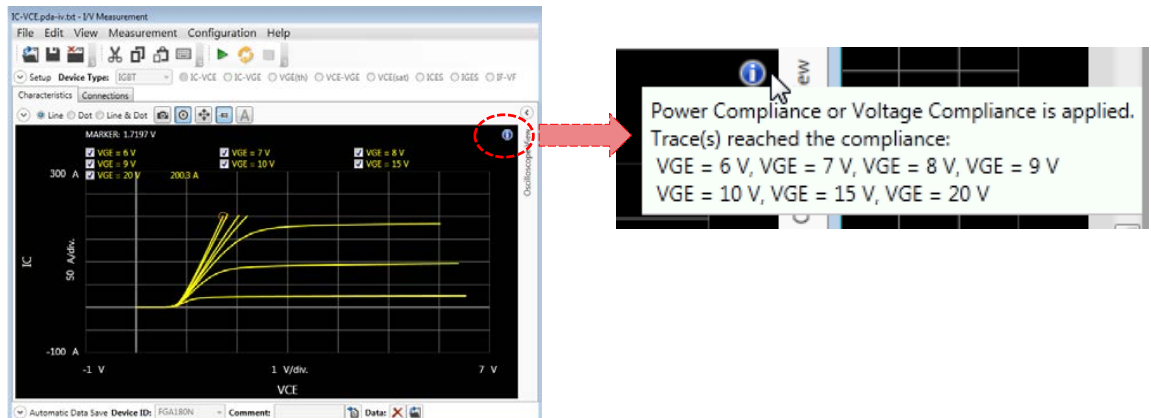

Datasheet Characterization

- ✓ To save the setup and the test result in the datasheet, save the setup by selecting “File”-->”Save”, or click save button in the ribbon menu.

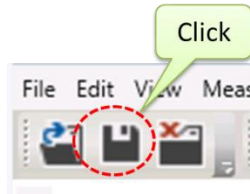

- ✓ The graph in the datasheet is updated as shown in Figure 2-69(b).

6.2 IC-VGE transfer characteristics

IC-VGE transfer characteristics measures the collector current by sweeping the gate voltage under the fixed collector voltage condition.

SMU must be used in the measurement which requires fixed Vce. The B1506A-H51/H71 model uses MPSMU, and the B1506A-H21 uses HCSMU.

The maximum output current used in this measurement is shown next.

- MPSMU: 100 mA
- HCSMU: 20 A

FGA180N33ATD measurement condition of IC-VGE transfer characteristics:

- ✓ VCE: 20 V
- ✓ ICE: 0 - 200 A
- ✓ VGE: 0 - 10 V

Note: The UHCU in B1506A-H51/H71 cannot hold the fixed voltage while the output current is changing due to the voltage drop by the output resistance of UHCU. Therefore the measurement results may differ from the expected test results. Refer to section “**How to set the voltage force mode setup**” for more details about this.

Note: To measure IC-VGE (or ID-VDS) at higher current, Ic-Vge for Expanders (or Id-Vgs for Expanders) application of EasyEXPERT is useful.

How to set up IC-VGE graphics measurement parameters

In the example measurement, MPSMU is used as the collector supply, and maximum current is 100 mA.

Follow the next steps to set up the parameters.

1. Graphic scale setup

Modify ranges of the vertical axis and the horizontal axis of the graphics the same as the datasheet by referring to Figure 2-71.

Figure 2-71

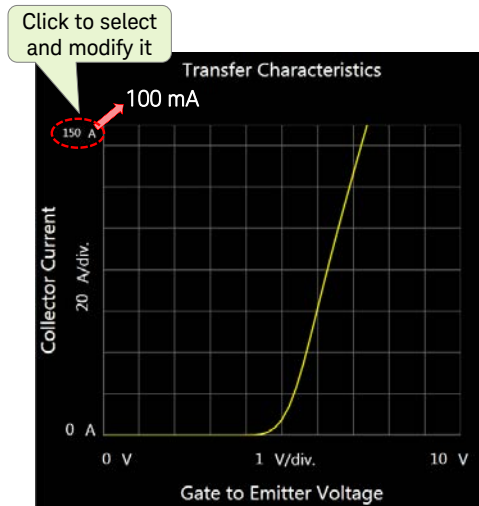

- ✓ Change the maximum collector current to 100 mA.

2. IC-VGE measurement setup

Modify the measurement setup by opening the IC-VGE I/V measurement setup window. (Refer to Figure 2-66, IC-VCE example to open the measurement setup window.)

- ✓ The IC-VGE setup window opens as shown in Figure 2-72.

Follow the next steps to set up the IC-VGE I/V measurement by following the number and corresponding one in the figure.

1. For IC-VGE I/V measurement, "IC-VGE" template of the I/V measurement is used.
2. Click the drive unit button (UHCU is selected), and drive selection pull-down menu opens.
3. Click "MPSMU".
4. MPSMU is set as the Drain/Collector voltage source, and the input field changes for MPSMU setup parameters.
5. Change Collector Pulse Bias source to 20 V.
6. Change the current compliance to 100 mA.
7. Note that the pulse width is set to 500 μ s.
8. Check the sweep stop V of the gate, 10 V.
9. Click the "Start Measurement" button.
IC-VGE measurement is made (Figure 2-73(a)).
10. Save the setup and the measurement data by pressing "save" icon. (Figure 2-73).
11. The datasheet graph is updated (Figure 2-73(b)).

Figure 2-72 An IC-VGE I/V measurement setup for MPSMU.

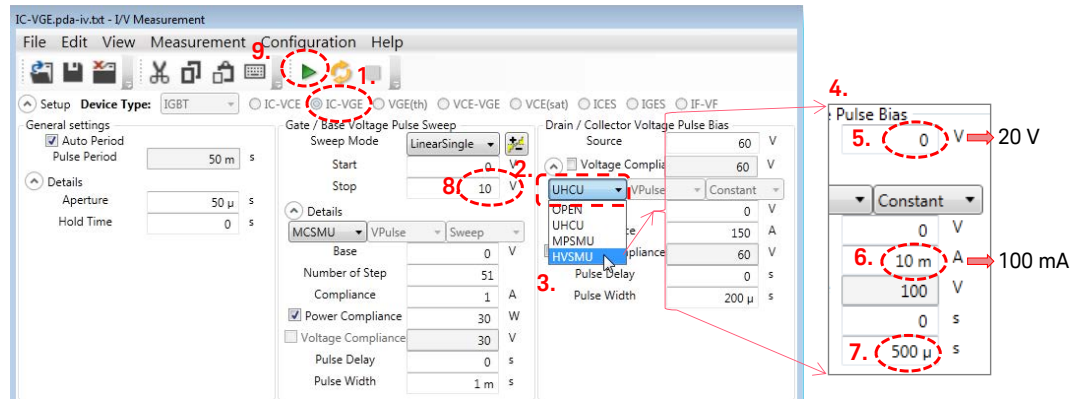
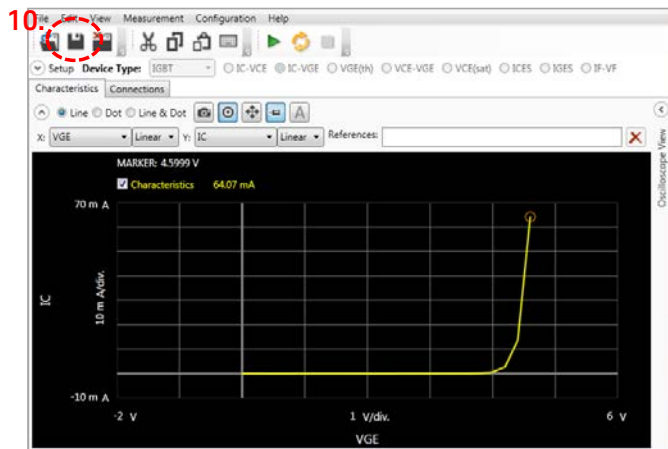
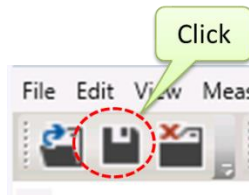
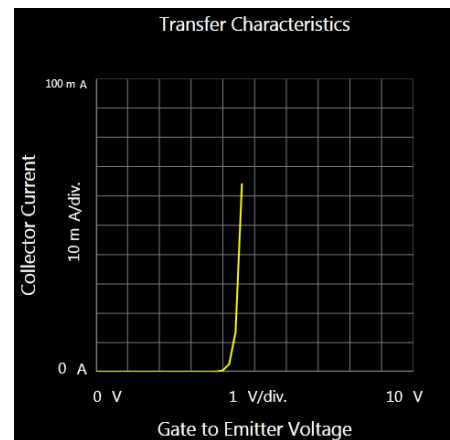

Figure 2-73

a) IC-VGE setup and the output.



11. b) Updated Datasheet graph.



Reference: High current IC-VGE measurement using UVCU:

You may have interest about the test result of IC-VGE using UVCU for measuring to more than 100 A. IC-VGE measurement using UVCU is introduced in "The IC-VGE output characteristics measurement using the UVCU" section.

How to measure IC-VGE characteristics under the threshold region

Since the default setup of IC-VGE measurement uses pulse mode, current measurement resolution is defined by the compliance current. With 100 mA compliance, current measurement resolution is 5 μA and it is not possible to measure characteristics lower than this.

Figure 2-74 shows measured IC-VGE curve in a log scale.

To change the scaling mode of the graph,

1. Click the graph icon at upper right of the graph to show the plot and axis setup,
2. Change the Y axis scaling mode to "PositiveLog",
3. Change the minimum value of the Y axis to 1 nA.

Figure 2-74 Low current area of IC-VGE characteristics

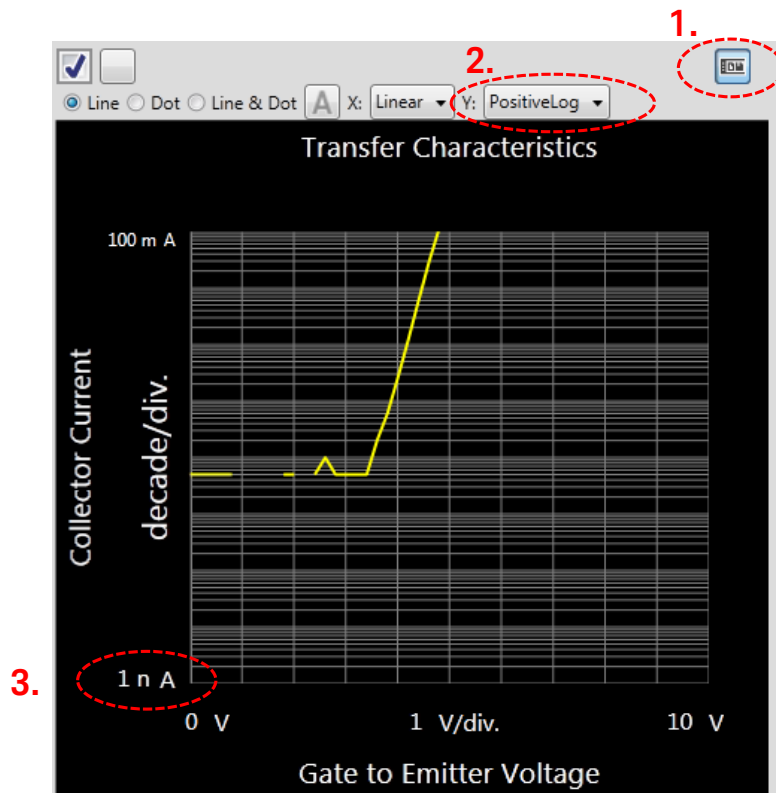

To measure IC-VGE characteristics at lower current range such as around threshold voltage, it is necessary to use “Fine” mode and to use the MPSMU in “V” mode (DC mode). But, default setup if IC-VGE are optimized to measure it at high current by using the UCHU or HCMU in pulse mode. In the setup, parameters critical to the parameters are locked to avoid measurement error caused by inappropriate settings.

To modify the locked parameters, it is necessary to use “Edit Setup” as shown in Figure 2-75,

- a) Right click the item and select “Setup” from the pop-up list.
- or
- b) Select the item and click the setup button in the ribbon menu

Figure 2-75 Changing the locked parameters in the setup

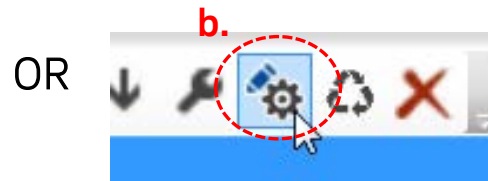
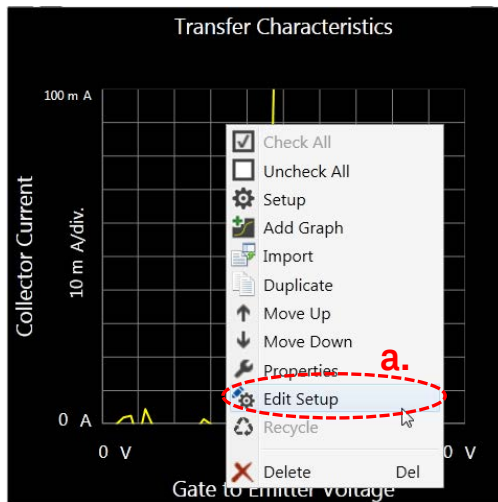

Change the setup as follows;

1. Change the output mode from “VPulse” to “V”.
Set 20 V as the source voltage and 100 mA as the current compliance.
2. Change the output mode from “VPulse” to “V”.
Set 0 V as the start voltage and 10 V as the stop voltage.
Set the number of step as 51.
Check “Power compliance”.
3. Change the trace mode to “Fine”.
4. Click the "Start Measurement" button.
5. Click the "Save" button to reflect the change to the datasheet level.

Figure 2-76 IC-VGE setup for lower current region

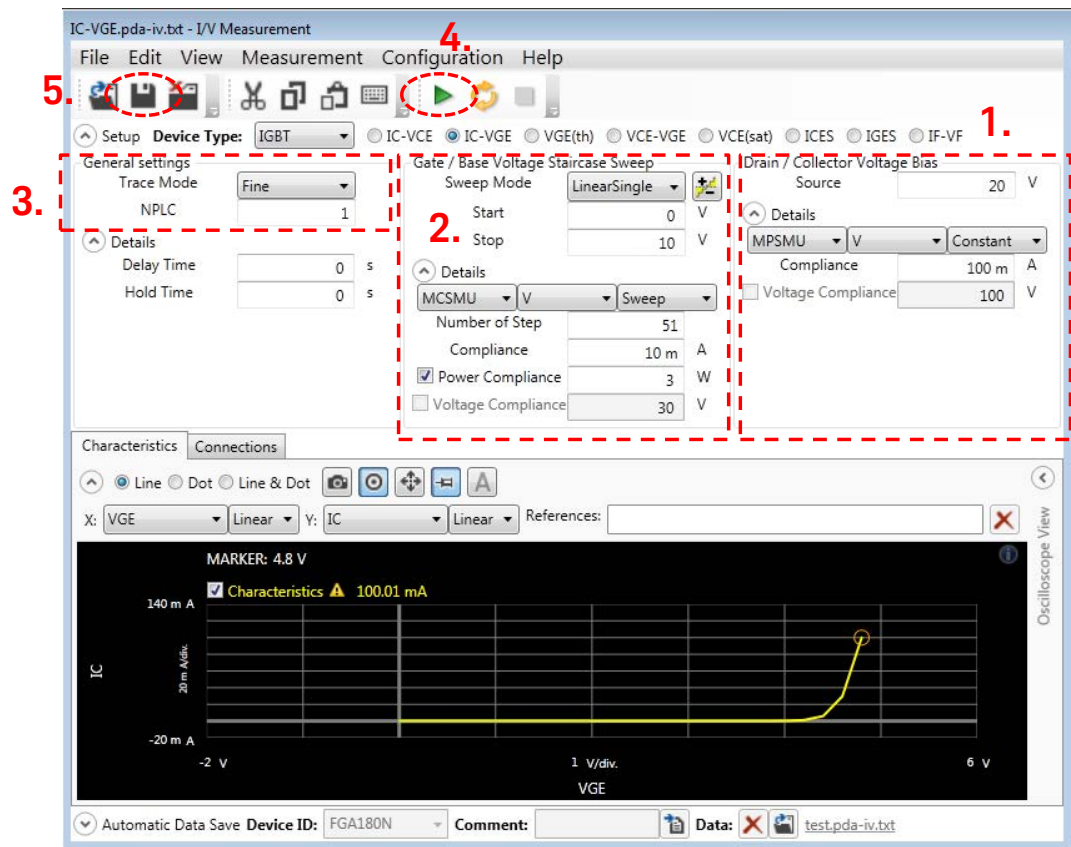

6. After saving the setup, a window to warn mismatch between the setup and the datasheet property appears (Figure 2-77).
- ✓ Click "OK" to move into the property editor.

Figure 2-77 Warning of a mismatch between the IV measurement setup and the datasheet setup

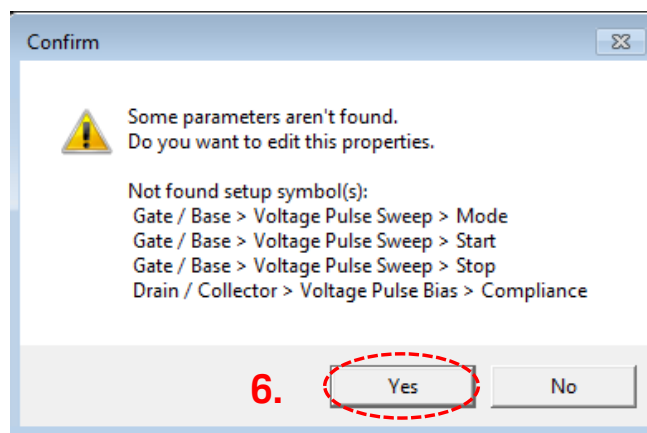

7. Select the “Graph” tab. In the graph pane, mismatched parameters are mark out in pink.
8. Change the setup related to the scaling mode of X axis to “Gate / Base > Voltage Staircase Sweep > Mode”.
9. Change the setup related to the minimum value of the X axis to “Gate / Base > Voltage Staircase Sweep > Start”.
10. Change the setup related to the maximum value of the X axis to “Gate / Base > Voltage Staircase Sweep > Stop”.
11. Change the setup related to the maximum value of the Y axis to “Drain / Collector > Voltage Bias > Compliance”.
12. Click “OK” to effect those changes.

Figure 2-78 Modification of the IC-VGE measurement property

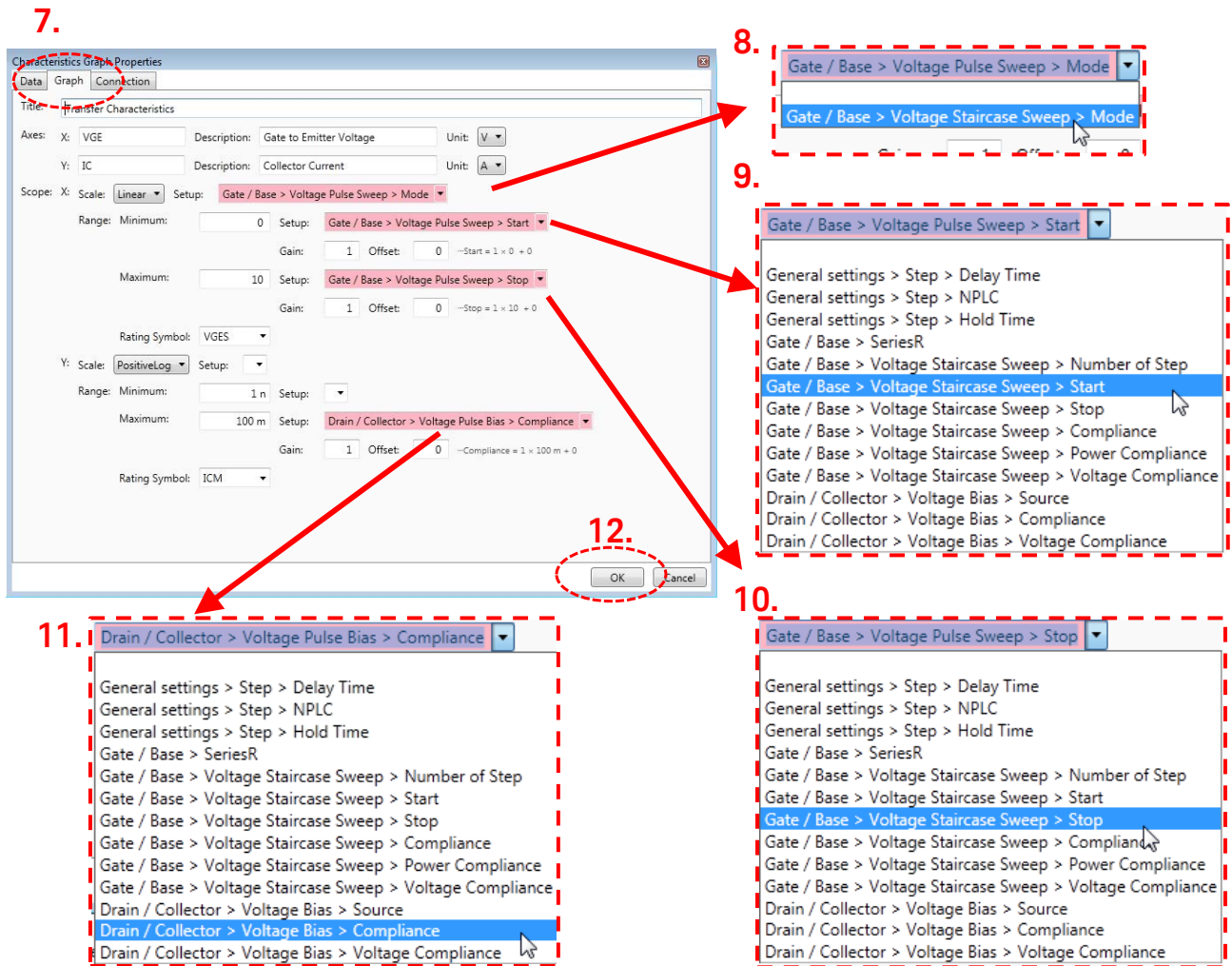

After updating the property of the graph, the graph is updated with a lower current in nA range (Figure 2-79).

Figure 2-79 IC-VGE result measured in the fine mode.

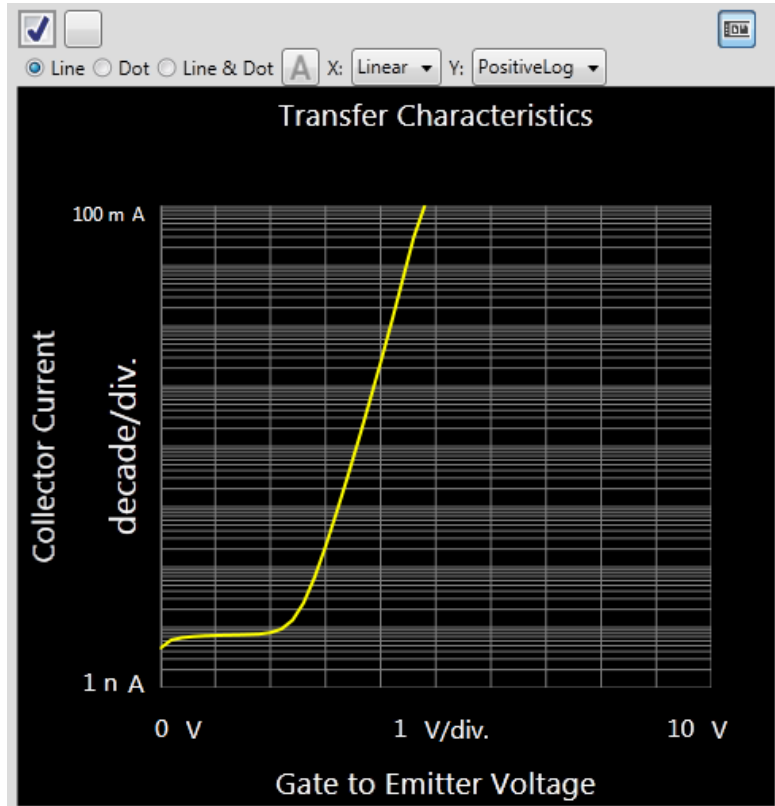

6.3 VCE-VGE characteristics - VCE(sat)

VCE-VGE characteristics is known as the collector saturation voltage characteristics, VCE(sat).

FGA180N33ATD Measurement condition of VCE-VGE transfer characteristics:

Figure 2-80 shows typical VCE(sat) versus VGE characteristics.

Figure 2-80

AVCE-VGE saturation voltage characteristics.

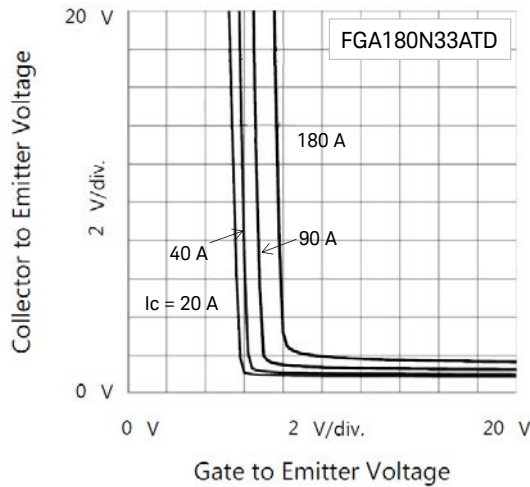

How to set up VCE-VGE graphics measurement parameters

Follow the next steps to set up the parameters.

1. Graphic scale setup

Modify ranges of the axis of the graphics the same as the datasheet by referring to Figure 2-81.

Figure 2-81

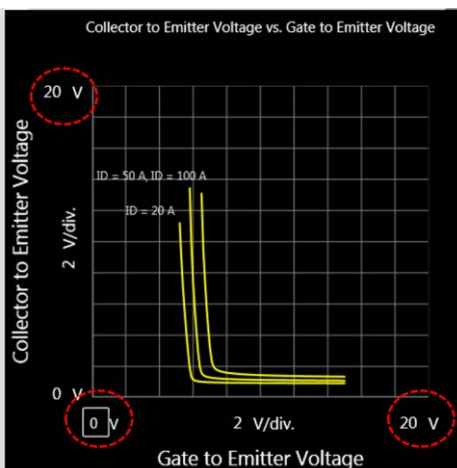

- ✓ Collector to Emitter voltage: 0 - 20 V
- ✓ Gate to Emitter voltage: 0 - 20 V

2. VCE-VGE I/V Measurement steps

Modify the measurement setup by opening the VCE-VGE I/V measurement setup window. (Refer to Figure 2-66, IC-VCE example to open the measurement setup window.)

- ✓ The VCE-VGE setup window opens as shown in Figure 2-82.

Follow the next steps to set up the VCE-VGE I/V measurement by following the number and corresponding one in the figure.

1. For VCE-VGE I/V measurement, "VCE-VGE" template of the I/V measurement is used.
2. Modify the list of the collector current same as the datasheet, as 20, 40, 90 and 180 A (Refer to Figure 2-82).
3. Gate / Base bias sweep range and the voltage compliance are inherited from the test conditions defined as the datasheet setup.
4. Modify the pulse width of the drain/collector current pulse setup from 500 μ s to 300 μ s. (Figure 2-83).
5. Click the "Start Measurement" button.
VCE-IGE measurement is made (Figure 2 84).
6. Save the setup and the measurement data by pressing "save" icon. (Figure 2 84). The datasheet graph is updated as Figure 2 85.

Figure 2-82 VCE-VGE I/V measurement setup for VCE(sat) measurement.

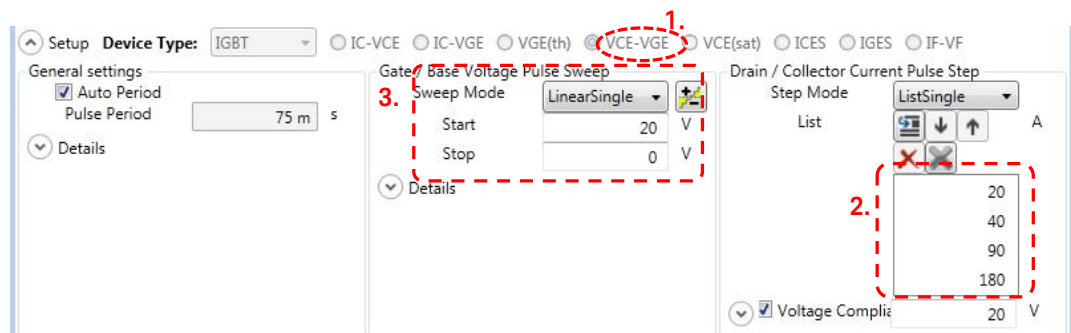

Figure 2-83 Pulse setup.

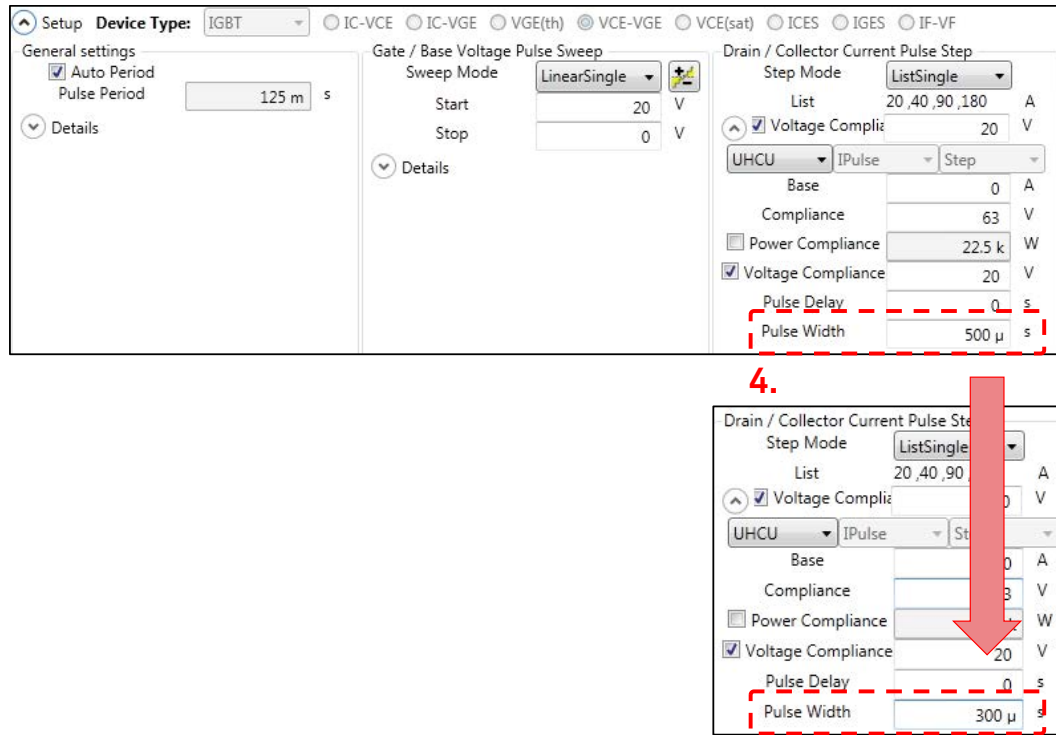

Figure 2-84 VCE-VGE measurement result.

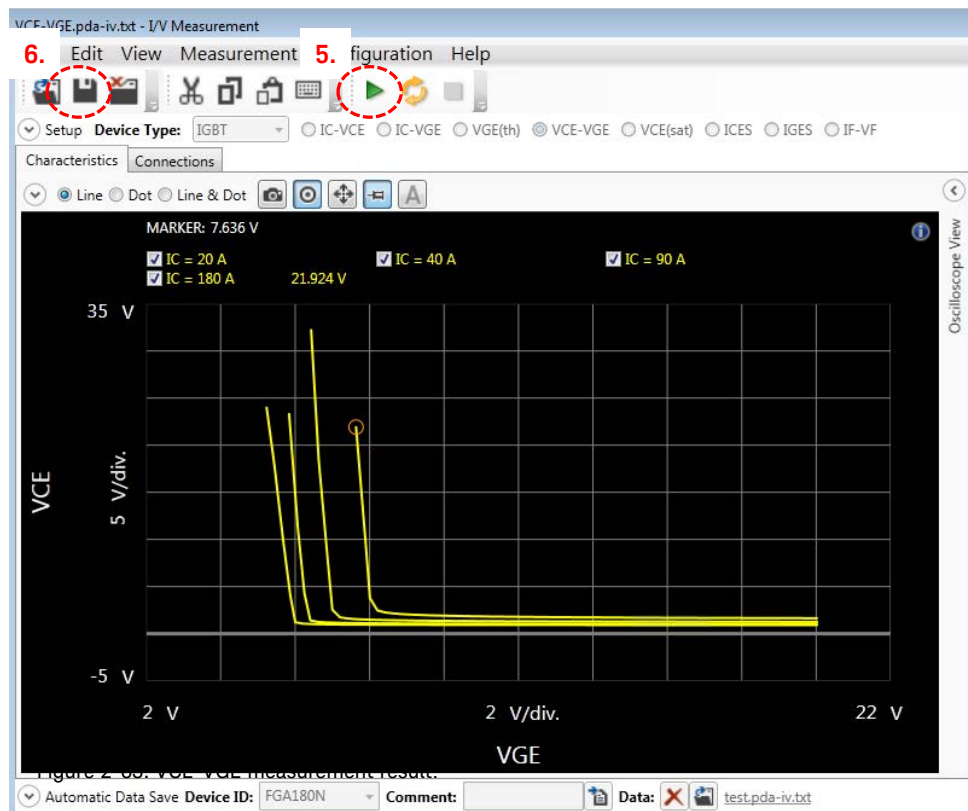
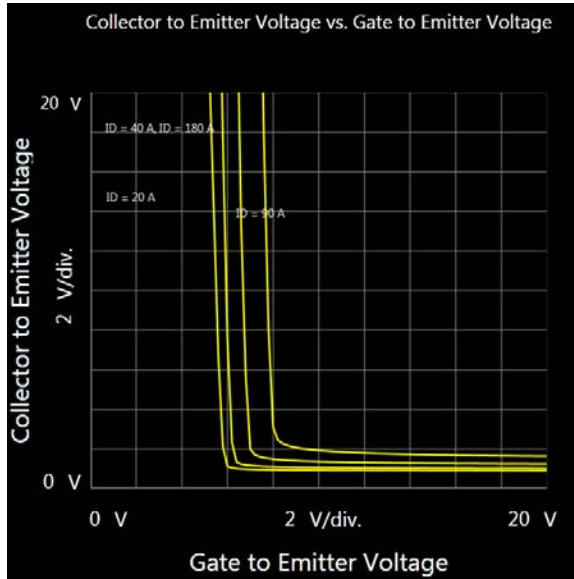



Figure 2-85 VCE-VGE graph updated in the datasheet characterization panel.



Note:

The pulse width used in VCE-VGE measurement has to be chosen carefully not to exceed the SOA limit of the device.

In this example, the maximum collector current and collector voltage are 180 A and 20 V respectively. Figure 2-86 shows the SOA characteristics of the device, UHCU's maximum output range in 500 A range, and the 180A - 20 V line. From the SOA characteristics of FGA180N33ATD, the maximum allowable pulse width is determined as 300 μ s to 400 μ s.

By reducing the compliance (voltage) setting to about 45 V, which satisfies the 180A and 20 V output in 500 A range, HCU's absolute output power can be also limited.

Figure 2-86

SOA limit and pulse width setting.

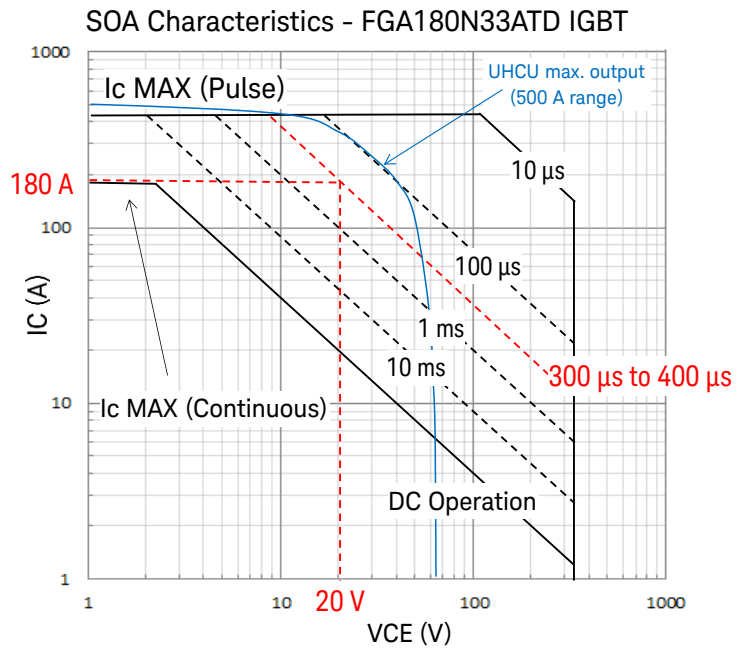

Tips:

How to determine an appropriate pulse width

Shorter pulses like those with a 200 μ s pulse width sometimes distort the VCE(sat) curve at the off state and may not be used in the case when the IC is small like 20 A, which is the specification parameter of ICE(sat) used in the example.

When using the 200 μ s pulse width, for example, measured VCE-VGE curve with 20 A collector current becomes erroneous as shown in Figure 2-87. The VCE curve shows a flat voltage at lower VGE where the device is close to off state.

This phenomenon is caused by a slow voltage rise time or response time at relatively low current when the UHCU is used in current force mode (IPulse).

Figure 2-87 VCE(sat) at 200 μ s pulse width.

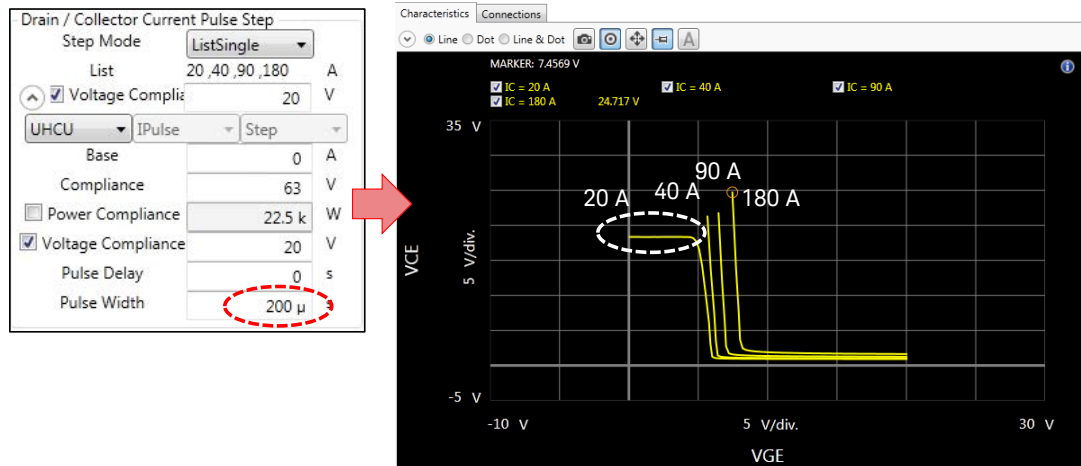
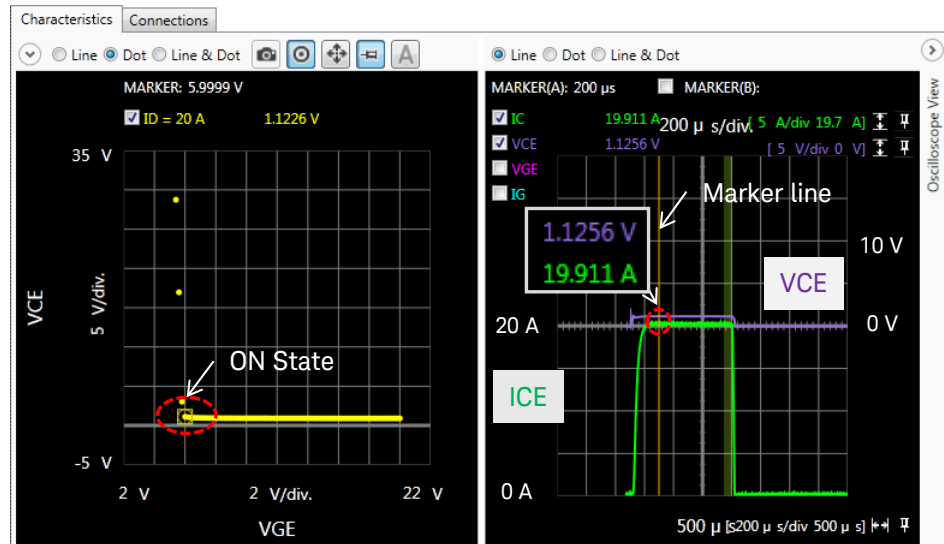

Figure 2-88 shows the VCE(sat) pulse waveforms of VCE and ICE in both on and off state when IC is set to 20 A and pulse width is 1 ms.

Figure 2-88(a) shows the on state VCE-VGE curve (left) and the pulse waveform on the right, where the ICE pulse rises up to the specified current (20 A) at 1.1256 V on voltage (refer to the pulse shape and marker reading at VCE =1.1256 V and IC =19.91 A at 200 μ s pulse position).

Figure 2-88 VCE(sat) Oscilloscope View of ON and OFF state.
 (a) ON state pulse



(b) OFF state pulse

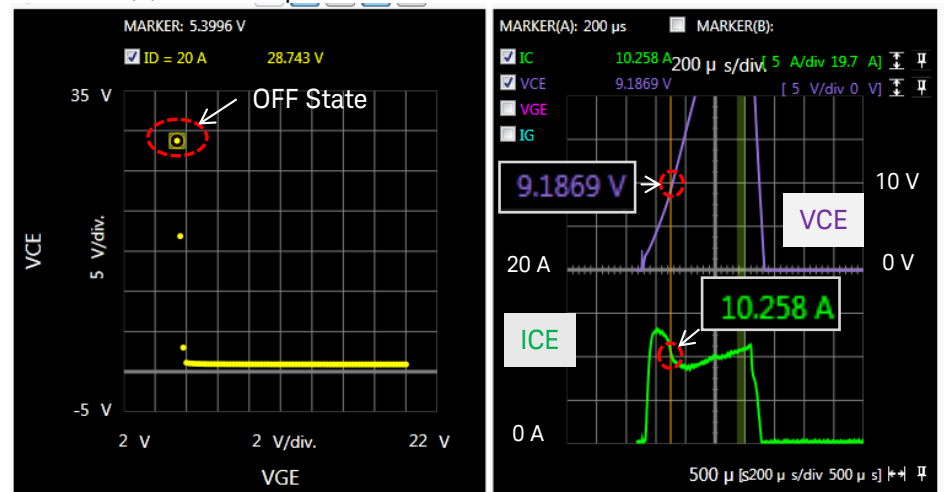

Figure 2-88(b) shows an example of the off state VCE-VGE curve at 1 ms pulse timing (left) and the pulse waveform (right) from 0 to 1ms span. Since the device is in off state, actually the specified ICE current (20 A) may not be forced. In the example case shown in the figure, the voltage pulse waveform is still in the middle of the voltage rise process, trying to force the specified 20 A current. As a result, the marker reading is 10.258A and 9.1869 V at 200 μs pulse timing, and this voltage reading is somewhat lower than the expected voltage considering the voltage waveform is still rising. (Note that the reading of the off-state voltage measurement is actually limited by the voltage compliance setting of the test setup.)

So, to measure the VCE(sat)-VGE curve using the constant current mode with various VGE settings, it is necessary to choose an appropriate pulse width to get the expected VCE-VGE curve as in the datasheet.

The following two conditions must be met to get a satisfactory result

- ✓ Short enough pulse for not to damage the device.
- ✓ Long enough pulse to raise the voltage enough.

Note:

Actually, the 1 ms pulse width is not allowed for VCE-VGE measurement with 180 A collector current in the example device because it exceeds the SOA limit. Even when using a shorter pulse width like 300 μ s as in the example, the measured voltage at the off-state is lower than the expected value.

But, one of the key points to measure the VCE-VGE curve is to know the VGE voltage that the VCE status changes from on to off.

The VCE-VGE slope in the off state is not so important, and the lower measurement voltage in the off state will not be an issue.

Note:

Regarding the usage of the oscilloscope view, refer to section "**How to use the Oscilloscope View**" in the section headed "**Measurement theory and detail explanation of the measurement capability**".

6.4 VF Freewheeling diode forward characteristics

How to set up VF graphics measurement parameters

Follow the next steps to set up the parameters.

1. Graphic scale setup

In the datasheet of this device, the vertical axis of the IV-VF chart is log scale.

Follow the next steps.

1. Modify the scale mode of the chart first. (Figure 2-89.)
Click the icon in the top-right corner of the chart to display the setting of scaling.
2. Change the scale mode of the Y axis from “Linear” to “PositiveLog”.
3. Modify the range of the vertical and horizontal axis according to the graph in the datasheet. (Figure 2-90)

Figure 2-89 Changing the Y axis scaling mode.

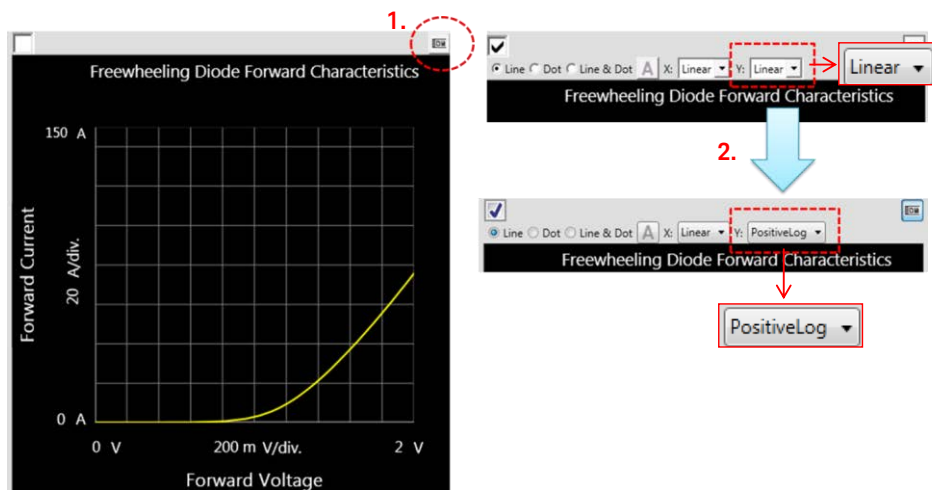
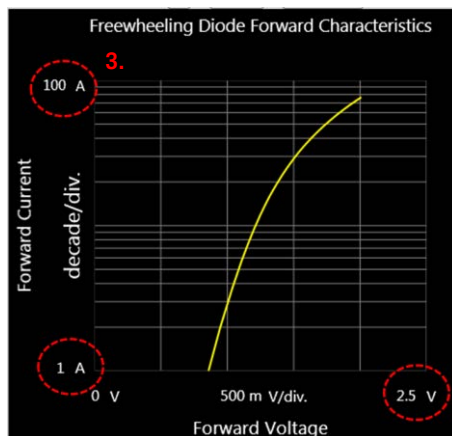

Figure 2-90 Changing the X and Y axis scaling.



2. VF measurement setup

Modify the measurement setup by opening the IF-VF I/V measurement setup window. (Refer to Figure 2-66, IC-VCE example to open the measurement setup window.)

Follow the next steps by referring to Figure 2-91.

4. Open the setup and modify the stop voltage high enough to cover the maximum current and voltage which are the maximum on voltage of the diode and the voltage drop of UHCU's output resistor as,

$$2.5 \text{ V} + 100 \text{ A} \times 120 \text{ m}\Omega = 14.5 \text{ V}$$
5. Set the number of steps properly to make measurement faster and also to maintain proper voltage steps.

Figure 2-91 IF-VF I/V measurement setup.

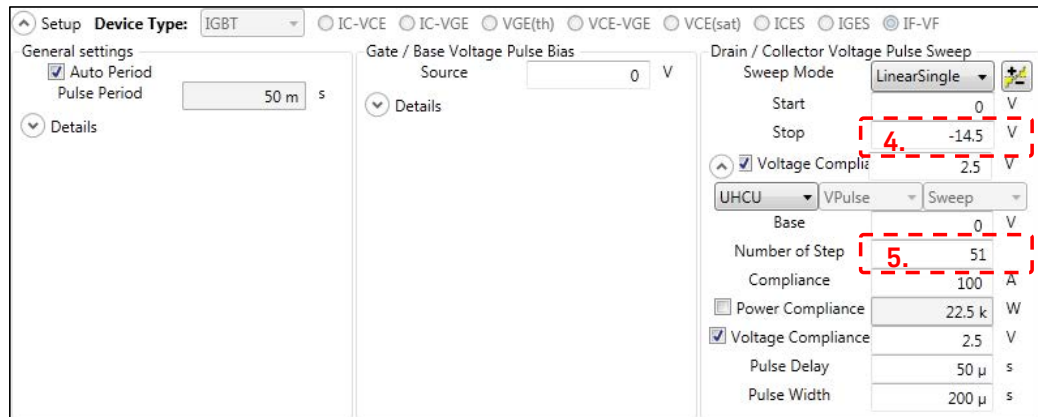

Verification of the IF-VF measurement setup

After the detail measurement setup is finished, it is recommended to perform the verification of the measurement setup

- ✓ Run the measurement.
- ✓ To save the setup and the test result in the datasheet, save the setup by selecting “File”-->”Save” or click the save icon in the ribbon menu.

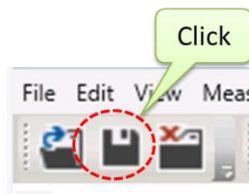

The IF-VF graph in the datasheet is updated as shown in
✓ Figure 2-92.

Figure 2-92

IF-VF Freewheel diode forward characteristics.

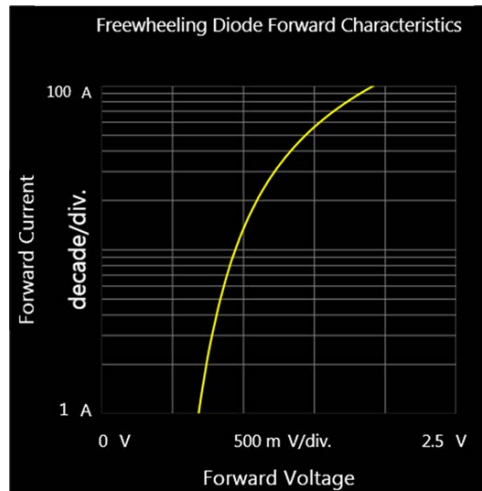

6.5 Other IV characteristics

Regarding measurement of other IV characteristics such as $R_{ds(on)}-I_d$, $R_{ds(on)}-V_{gs}$ or $V_{ds}-V_{gs}$ of power MOSFET, please refer to “**I/V Measurement**”.

6.6 CV characteristics

How to set up CV graphics measurement parameters

Follow the next steps to set up the parameters.

1. Graphic scale setup

Modify the scaling mode to "Linear" and the range of the vertical and the horizontal axis according to the CV graph shown in the datasheet.

Follow the next steps.

1. Modify the scale mode of the chart first. (Refer to Figure 2-93.) Click the icon in the top-right corner of the chart to display the setting of scaling.
2. Change the scale mode of the Y axis from “PositiveLog” to “Linear”.
3. Modify the range of the vertical and horizontal axis according to the graph in the datasheet. (Figure 2-94)

Figure 2-93 Changing a scaling mode.

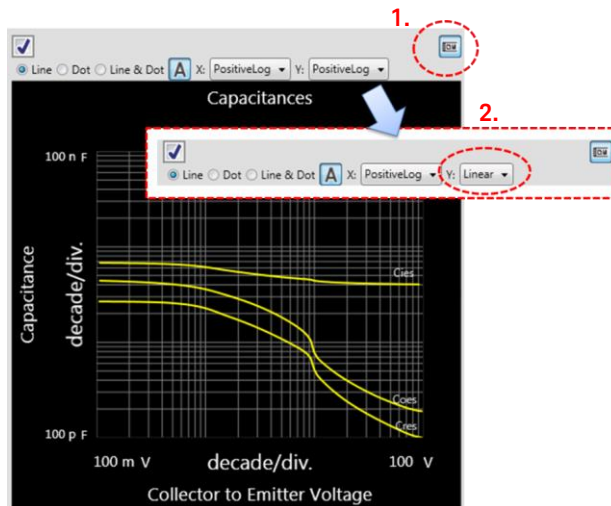
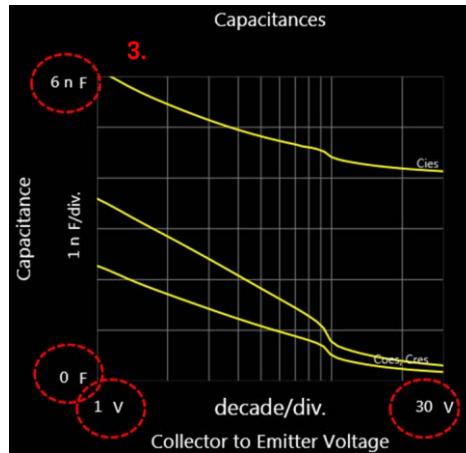

Figure 2-94 Change the X and the Y axis scaling.



2. CiesCoesCres-VCE CV measurement setup

Modify the measurement setup by opening the **CiesCoesCres-VCE** measurement setup window. (Refer to Figure 2-66, IC-VCE example to open the measurement setup window.)

- ✓ Modify the measurement frequency according to the condition defined in the datasheet. (Refer to Figure 2-95.)

Note: If the measured CV curves differ from the curves in the datasheet, try to change the frequency to 100 kHz to reduce influences from residual inductance, resistance and stray capacitance of the switching system.

Figure 2-95 CiesCoesCres-VCE measurement setup

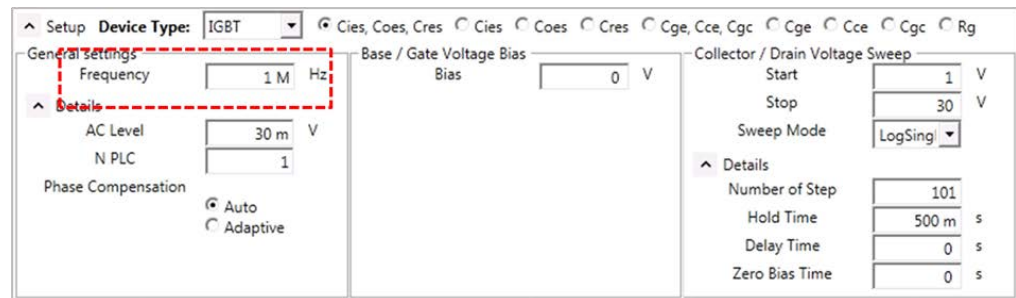

Verification of the CV measurement setup

After the detail measurement setup is finished, it is recommended to perform the verification of the measurement setup

- ✓ Run the measurement.
- ✓ To save the setup and the test result in the datasheet, save the setup by selecting “File”-->”Save”.

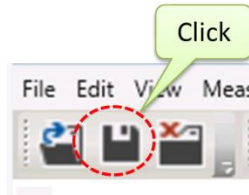

- ✓ The CV graph in the datasheet is as shown in Figure 2-96.

Figure 2-96

Cies, Coes, Cres-VCE datasheet characteristics graph.

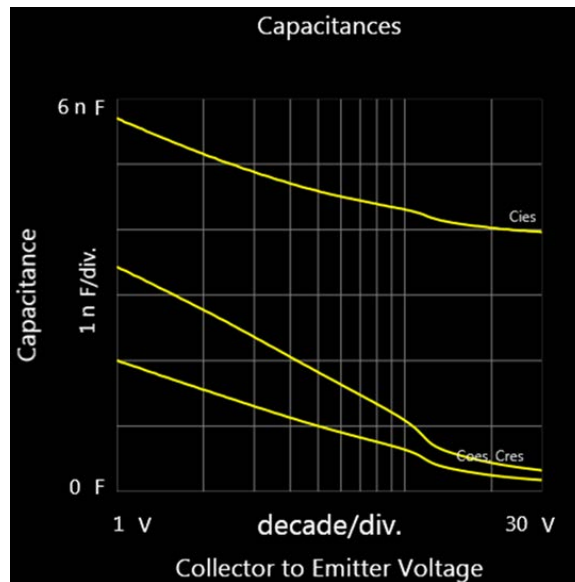

6.7 Vge-Qg gate characteristics

Depending on the devices in the market, multiple Qg curves with different measurement conditions are described in the same characteristics graph, for example at two different Vcc test conditions.

The Qg graph of the datasheet mode can only display curves with a single measurement condition. Therefore, it is necessary to duplicate the setup to display multiple Qg graphs of different test conditions.

How to set up Qg graphics measurement parameters

Follow the next steps to set up the parameters.

1. Graphic scale setup

Modify the range of the vertical axis and horizontal axis of the Qg graph according to the datasheet (Figure 2-97).

Figure 2-97

Qg graph scaling (IC = 40 A, VCE = 100 V).

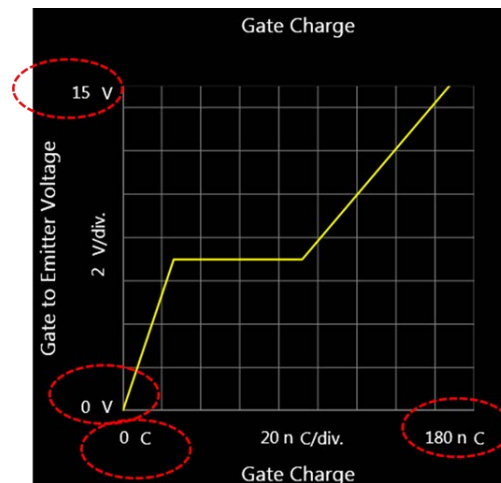

2. VGE-Qg measurement setup

Modify the measurement setup by opening the VGE-Qg gate charge measurement setup window. (Refer to Figure 2-66, IC-VCE example to open the measurement setup window.)

- ✓ Modify the test setup the same way as shown in Figure 2-98. The same collector current as the Qg datasheet parameters is also used to measure the VCE-Qg graph.

Figure 2-98 Vge-Qg Gate charge measurement setup.

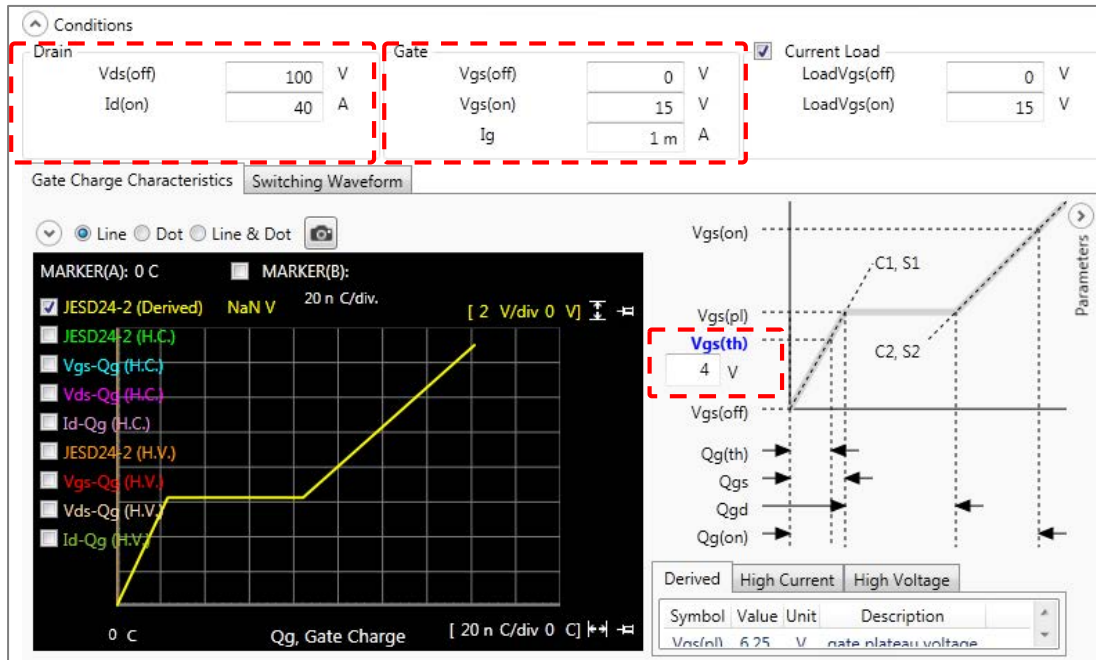

Verification of the Qg measurement setup

After the detail measurement setup is finished, it is recommended to perform the verification of the measurement setup

- ✓ Run the measurement.
- ✓ To save the setup and the test result in the datasheet, save the setup by selecting "File"-->"Save".

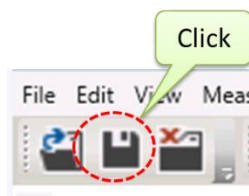

- ✓ The Qg graph in the datasheet is updated after finishing the measurement

How to set up the 2nd Qg graphics measurement

- ✓ Duplicate the modified setup and modify the off voltage of the duplicated VGE-Qg graph.

How to duplicate a graph:

Figure 2-99 shows two ways to duplicate the graph.

(a) Simply right click on the graph and click on the Duplicate pop-up menu, or (b) click on the "Duplicate" button in the ribbon menu after selecting the graph.

Figure 2-99 Duplicating graph setup (IC = 40 A, VCE = 200 V).

(a) Right click, and select from the pop-up menu.

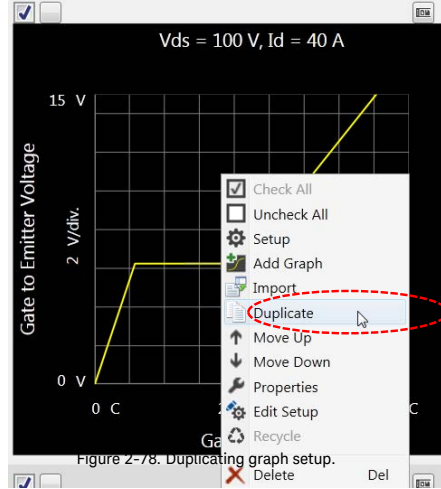

(b) Select from the menu bar.



How to set up off voltage

- ✓ Set second $V_{ds(off)}$ test condition (Figure 2-100).

Figure 2-100 2nd V_{ge-Qg} Gate charge measurement setup for different V_{ds} .

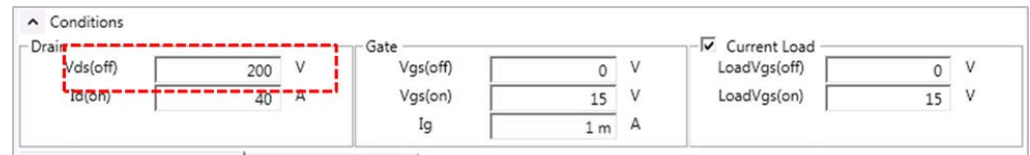

Verification of the 2nd Q_g measurement setup

Verify the measurement as the same way of the first parameter measurement and save the setup.

Step 7 Updating the entire setup

To update the modified setup of the entire measurement, select “Save” to update the current setup or “Save as” to save it under a different file name.

Step 8

Run a test of the entire parameters and graphs

To run the entire measurement, confirm that all measurement items are “Checked”, and then click the “Measure button.”

1. How to start test

- ✓ Click the “Measure button.”
The measure button is shown in Figure 2-101.

Figure 2-101 Start measure button.

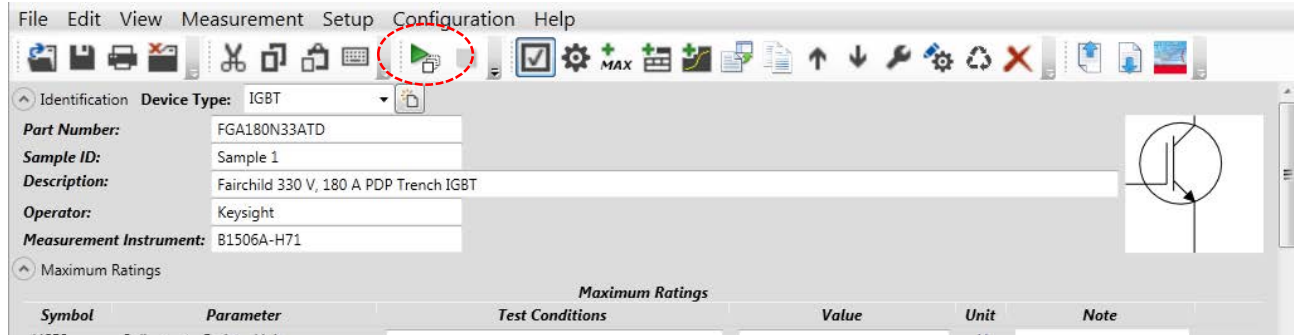

Measurement options

The datasheet measurement mode has three options as shown in Figure 2-102 and Figure 2-103.

- ✓ "Without data cleared" option starts measurement by keeping the existing data, and updates the existing result after the new measurement has finished. (Refer to Figure 2-104.)
- ✓ "With data cleared" option clears all the existing data and starts new measurements. (Refer to Figure 2-105.)
- ✓ If the “Stop if an actual value is out of range” option skips consequent measurement after the actual measured value exceeds the specified minimum/maximum value (Refer to Figure 2-106). The window to indicate the measurement is stopped will pop up.

Note: The window to indicate the measurement is stopped does not pop up if the measurement is automatically triggered by Thermal Monitor/Control function of Easy Test Navigator

Figure 2-102 Start options.

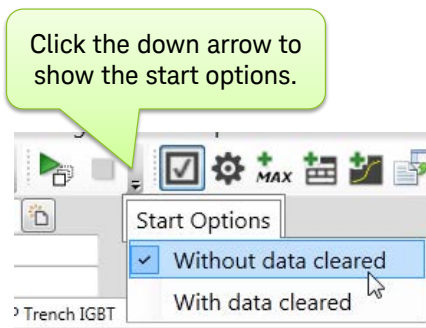

Figure 2-103 Option to abort the consequent measurement if the measured value is out of range.

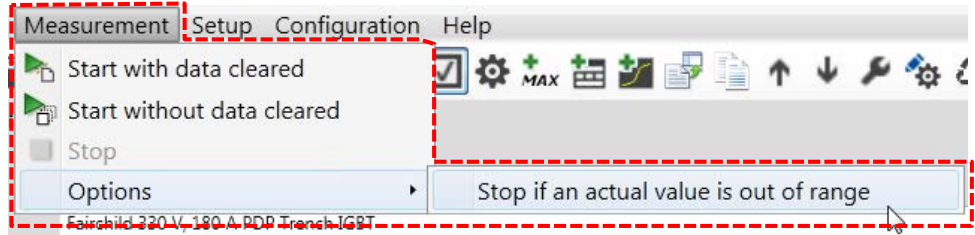

Figure 2-104 Measurement under the "Without data cleared" option.

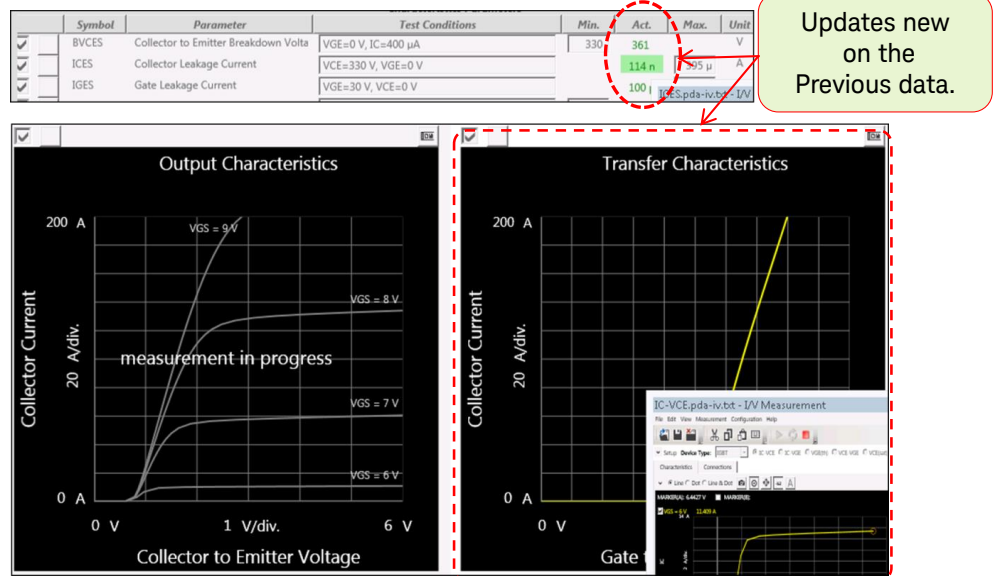

Figure 2-105 Measurement under the "With data cleared" option.

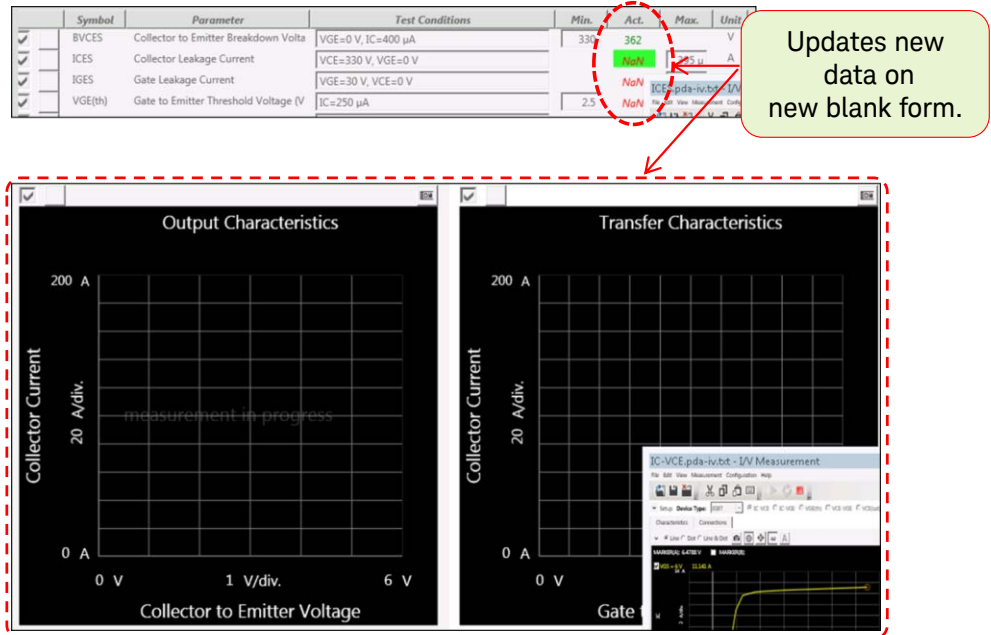
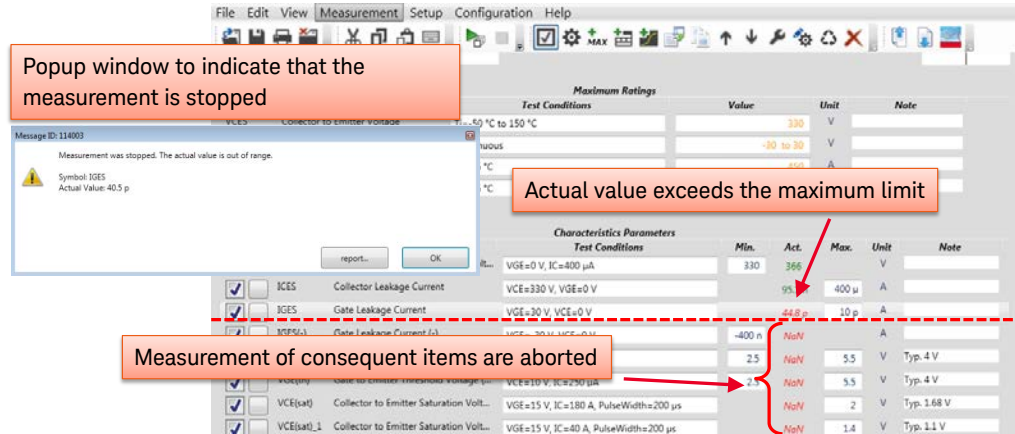

Figure 2-106 Measurement with the "Stop if actual value is out of range" option.



2. Device setup confirmation for I/V and CV measurements

- ✓ At the beginning of the measurement, the dialogue box shown in Figure 2-107 appears.
- ✓ This dialog box indicates the check of the connection for IV/CV measurement.
- ✓ After the confirmation of the connection, click “OK” to start the measurement.

Figure 2-107 Dialog box for confirming the connections for I/V and CV measurements.

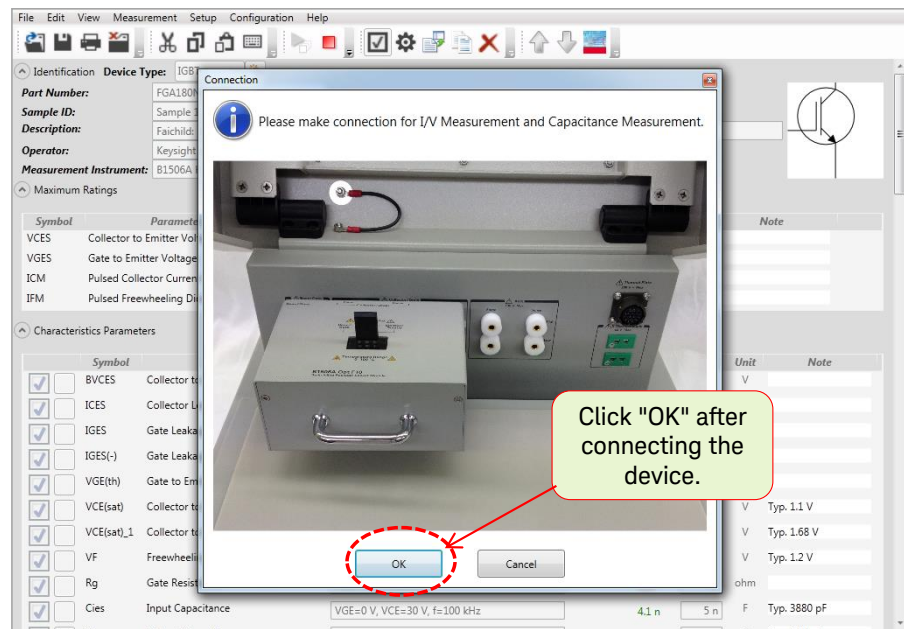

- ✓ All the device parameter and graphics characterization measurements except for the Q_g measurement are performed sequentially.
- ✓ Basically, measurement starts from the top to the bottom of the list as shown in Figure 2-108.

Note: After the completion of all the measurements for IV and CV items, the dialogue box indicating to check for the connection of Q_g measurement appears

Figure 2-108 Test continues from the top to bottom.

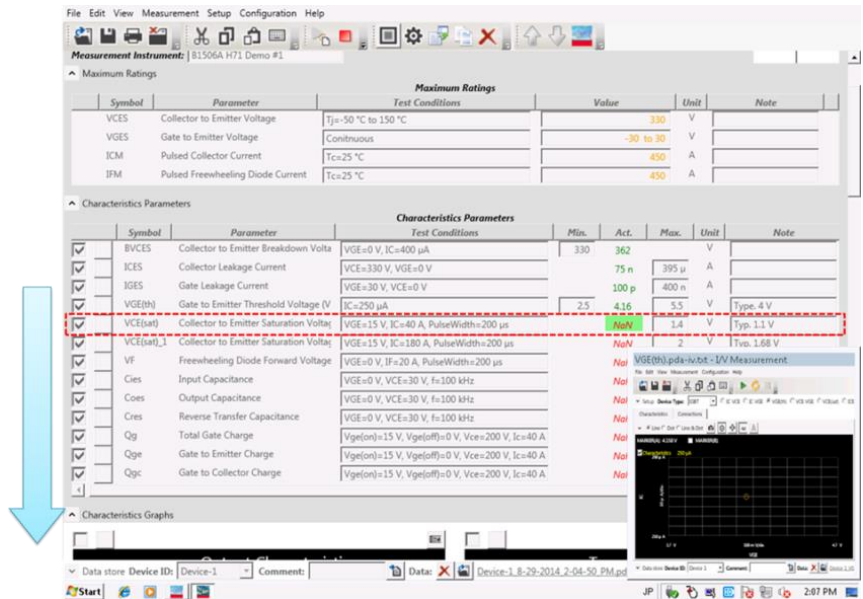

- ✓ After the completion of the IV and CV parameter measurement, the test continues to the graphics characteristic measurements.
- ✓ During the measurement (Refer to Figure 2-109)
 1. The graph under measurement is blinking and
 2. The small window of each measurement mode appears in the bottom right of the screen.

Figure 2-109 Graphic characteristic measurements.

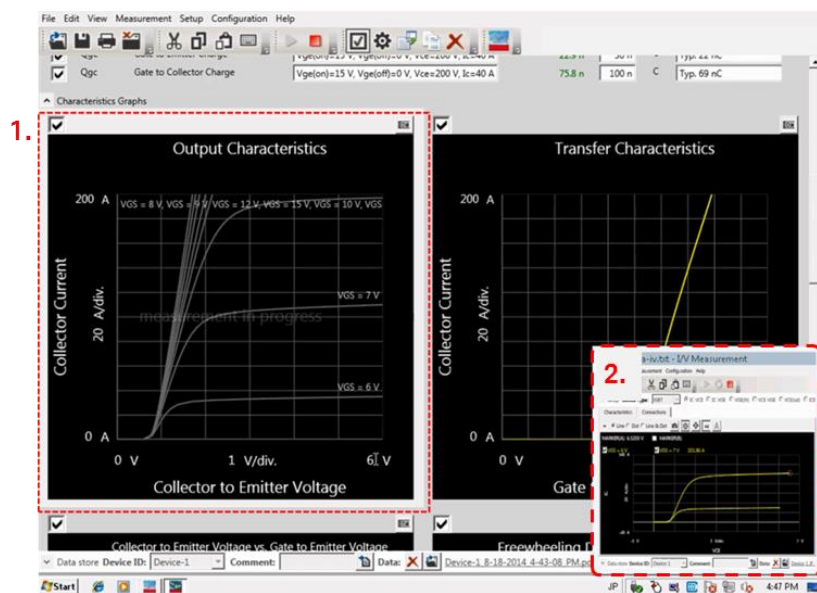

3. Device setup confirmation for Qg measurements

- ✓ After the completion of all the measurements for the IV and CV items, the dialogue box indicating to check for the connection of Qg measurement setup appears as shown in Figure 2-110.
- ✓ After the confirmation of the connection, click "OK" to start measurement.
- ✓ After finishing the entire measurement, the results are automatically saved in the pre-defined directory shown in Figure 2-111.

Figure 2-110

Dialog box for confirming the connections for Qg measurements.

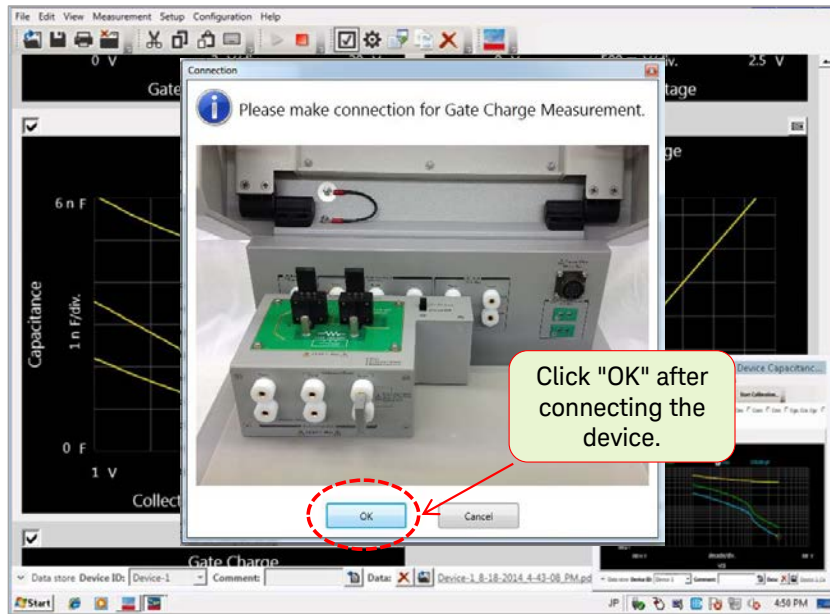
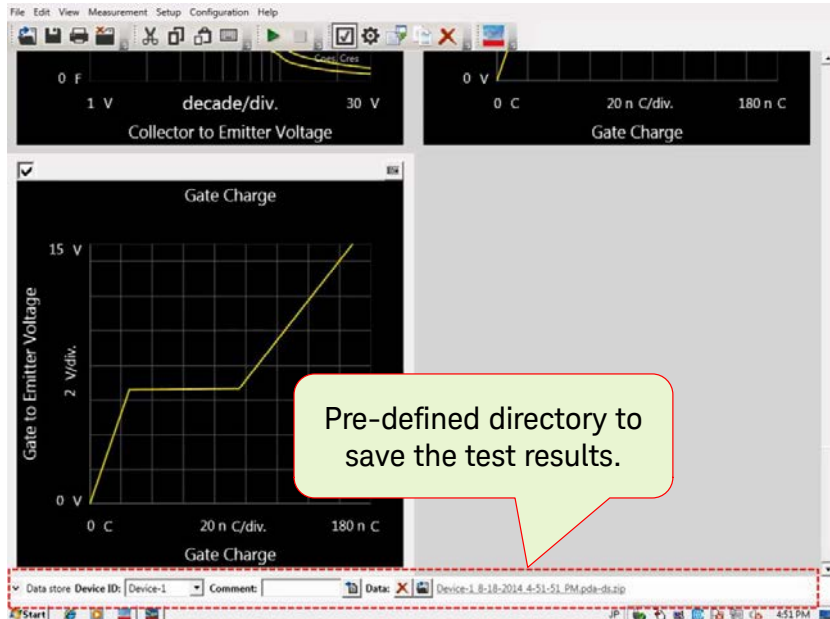

Figure 2-111

Auto-save the results to pre-defined directory.



Tips:

**How to change the order of the measurement
Method 1: Sequence control using a priority group**

It is possible to prioritize each measurement item.

- ✓ There are three priorities, first, second and third.



- ✓ Priority can be changed by clicking the button.

Click the button to toggle the priority

Symbol	Parameter
<input checked="" type="checkbox"/>	BVCES Collector to Emitter Bri
<input checked="" type="checkbox"/>	ICES Collector Leakage Curr
<input checked="" type="checkbox"/>	IGES Gate Leakage Current
<input checked="" type="checkbox"/>	VGE(th) Gate to Emitter Thresh
<input checked="" type="checkbox"/>	VCE(sat) Collector to Emitter Sa
<input checked="" type="checkbox"/>	VCE(sat)_1 Collector to Emitter Sa
<input checked="" type="checkbox"/>	VF Freewheeling Diode Fo
<input checked="" type="checkbox"/>	Cies Input Capacitance
<input checked="" type="checkbox"/>	Coes Output Capacitance
<input checked="" type="checkbox"/>	Cres Reverse Transfer Capa
<input checked="" type="checkbox"/>	Qg Total Gate Charge

- ✓ Measurement starts from the top item in the first priority group to the bottom.
- ✓ Next, move to the top item in the second priority group.
- ✓ After finishing the second priority group, measurement of the third priority group starts.

It is possible to skip specific items by removing the "check" mark from the listed items.

<input type="checkbox"/>	VCE(sat)
<input type="checkbox"/>	VCE(sat)_1
<input checked="" type="checkbox"/>	VF

- ✓ You can add/remove the check mark of all items.

Note:

Even if the priority of Qg measurement is set as first priority, Qg measurement starts after completing the entire IV and CV measurement including the parameter and graph items.

Note:

Even if the order of measurement is changed by specifying the priority, the order of items in a printed report is not changed.

Method 2: Changing the order of items

To change the order of the items in the printed report, or to change the order of measurement in the same priority, it is necessary to change the order of items in the setup. It is possible to change the order of the items by moving up / down the selected item as described in Figure 2-112.

Figure 2-112 Changing the order of the items

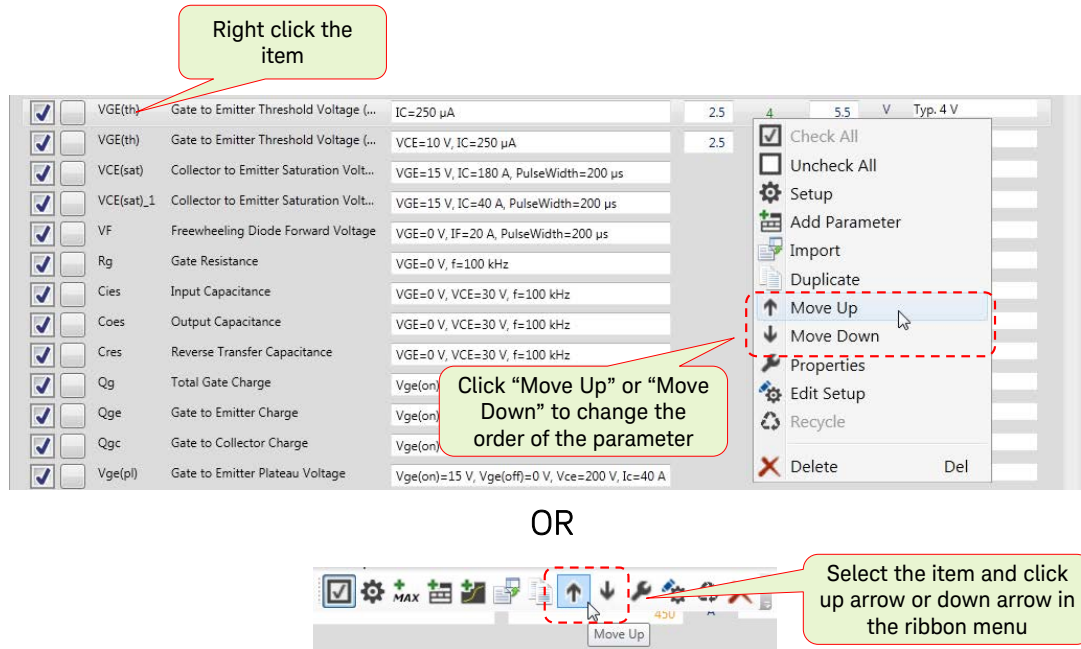

Method 3: Changing the picture of the connection

The priority of the items are also determined by the diagram used in the connection confirmation window (Figure 2-113). As the default, the picture of the standard TO socket adapter is used as the connection diagram.

Figure 2-113 Default connection confirmation window of IV and CV measurement



The diagram used in the connection confirmation window is defined in the connection tab of the item property. To change the diagram, open the property of the item (Figure 2-114), select the connection tab and import the picture used for the item (Figure 2-115).

Figure 2-114 Opening the property of the item

Right click the item

Symbol	Parameter	Test Conditions	Min.	Act.	Max.	Unit	Note
<input checked="" type="checkbox"/>	BVCES	Collector to Emitter Breakdown Volt...	VGE=0 V, IC=400 μ A	330	366	V	
<input checked="" type="checkbox"/>	ICES	Collector Leakage Current	VCE=330 V, VGE=0 V	95.5 n			
<input checked="" type="checkbox"/>	IGES	Gate Leakage Current	VGE=30 V, VCE=0 V	25.9 p			
<input type="checkbox"/>	IGES(-)	Gate Leakage Current (-)	VGE=-30 V, VCE=0 V	-400 n	-27.3 p		
<input type="checkbox"/>	VGE(th)	Gate to Emitter Threshold Voltage (...)	IC=250 μ A	2.5	4		
<input type="checkbox"/>	VGE(th)	Gate to Emitter Threshold Voltage (...)	VCE=10 V, IC=250 μ A	2.5	4		
<input type="checkbox"/>	VCE(sat)	Collector to Emitter Saturation Volt...	VGE=15 V, IC=180 A, PulseWidth=200 μ s	1.7			
<input type="checkbox"/>	VCE(sat)_1	Collector to Emitter Saturation Volt...	VGE=15 V, IC=40 A, PulseWidth=200 μ s	1.04			
<input type="checkbox"/>	VF	Freewheeling Diode Forward Voltage	VGE=0 V, IF=20 A, PulseWidth=200 μ s	1.14			
<input type="checkbox"/>	Rg	Gate Resistance	VGE=0 V, f=100 kHz	841 m			
<input type="checkbox"/>	Cies	Input Capacitance	VGE=0 V, VCE=30 V, f=100 kHz	605 n			

Click "Properties" to open the property of the item

- Check All
- Uncheck All
- Setup
- Add Parameter
- Import
- Duplicate
- Move Up
- Move Down
- Properties
- Edit Setup
- Recycle
- Delete Del

Figure 2-115 Importing the connection diagram



The supported formats of the diagram are BMP, GIF, JPG, PNG and TIF. The imported files are built-in to the datasheet setup and results file. To reduce the size of the result, it is recommended to resize the picture for it to fit the diagram canvas (640 x 360 pixels).

Figure 2-116 Default connection confirmation window of the IV and CV measurement

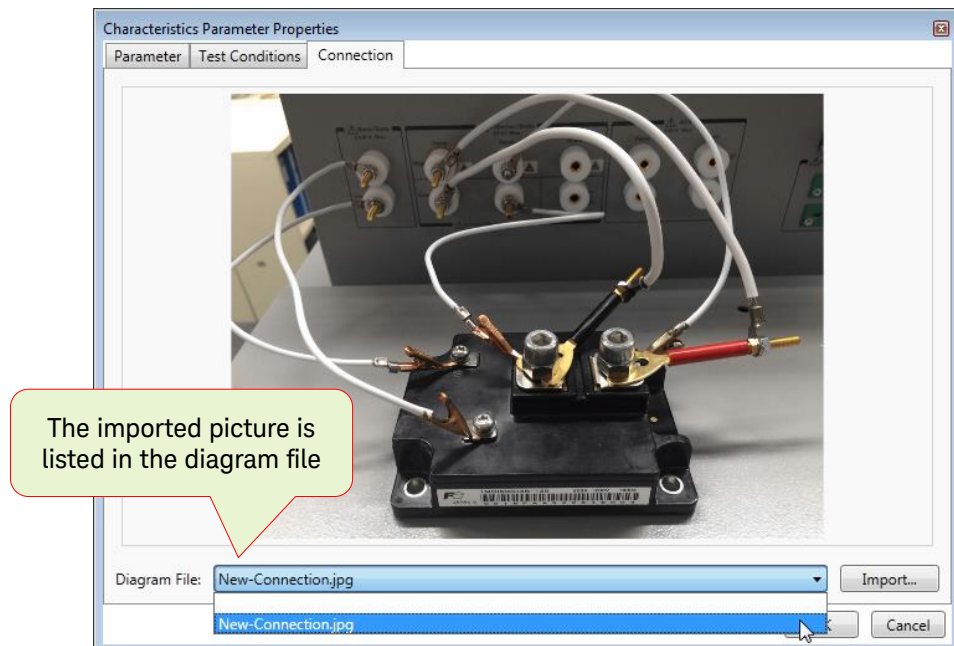

Once the diagram is imported, it appears in the list of diagrams. To use the same diagram for the other items in the same datasheet setup, select it from the list.

Note: To use the default picture, select blank from the list of the diagram file.

The priority of measurement using the customized diagram picture is determined as following order.

- The priority of the IV and CV measurement is higher than the Qg measurement.
- The priority defined by the priority group function is higher than the priority determined by the diagram picture.
- The priority of items using the default picture is higher than items using customized diagram pictures.

For example, the items using the customized diagram picture categorized in the first priority group are executed before executing the items using the default picture categorized in the second priority group.

The connection confirmation window pops up before measuring the item using a different diagram picture.

Step 9 Reviewing and checking the printing image of the measurement result

How to review the test results:

To review the test result, click the down arrow in the bottom left of the screen to expand the test result viewer.

The area expands, and you can see the test data files.

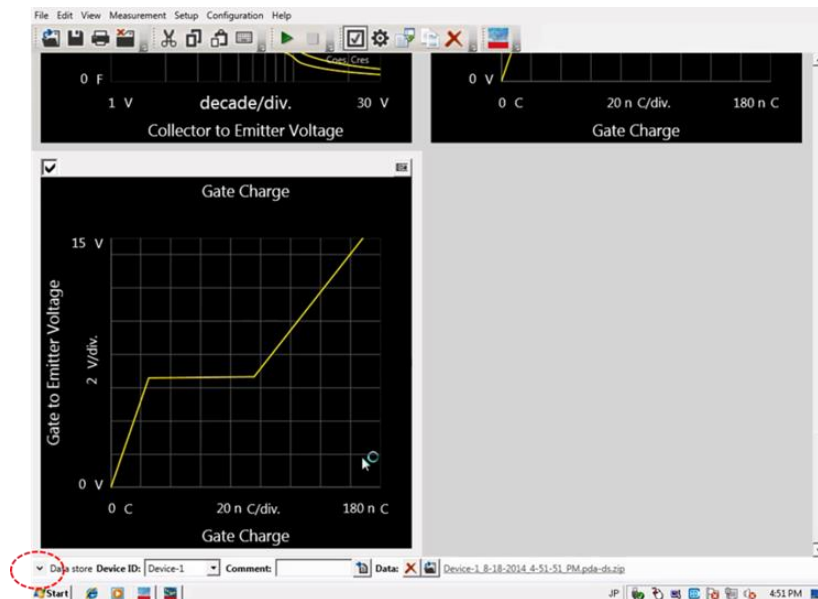

How to recall test result:

To recall the test result, click the name of the result in the recent data area, or click the "File" icon at the left of the latest test result file.

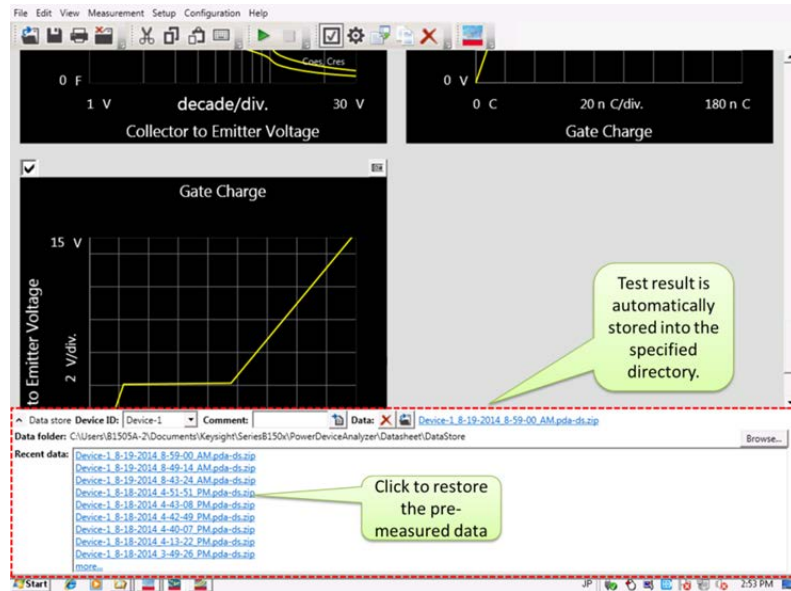

How to display the test results in the datasheet image:

The test result can be printed as the same image as the datasheet. Click File -> Print of the datasheet characterization drop down menu, or click the printer icon in the ribbon menu of the Datasheet characterization panel.

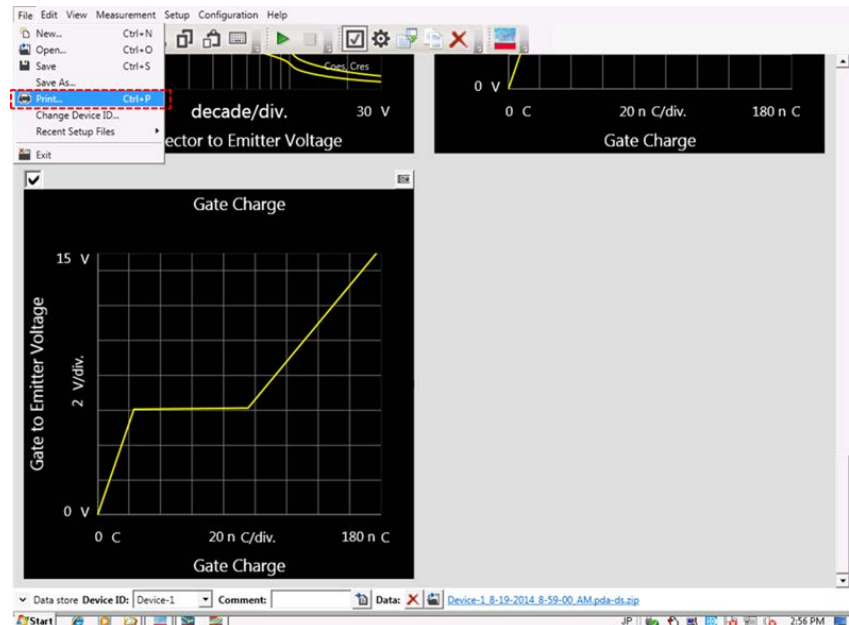

Datasheet Characterization

The print pre-view panel opens.

Print Datasheet

Part Number: FGA180N334TD
 Device ID: Sample 1
 Description: Fairchild 330 V, 180 A PDP Trench IGBT

Maximum Ratings

Symbol	Parameter	Test Conditions	Value	Unit	Note
V _{CE}	Collector to Emitter Voltage	T _j =50 °C to 150 °C	330	V	
V _{GE}	Gate to Emitter Voltage	Continuous	-30 to 30	V	
I _{CM}	Pulsed Collector Current	T _c =25 °C	450	A	
I _{FM}	Pulsed Free-wheeling Diode Current	T _c =25 °C	450	A	

Characteristics Parameters

Symbol	Parameter	Test Conditions	Min.	Act.	Max.	Unit	Note
B _V CE _S	Collector to Emitter Breakdown Voltage	V _{GE} =0 V, I _C =400 μA	330	364.271		V	
I _{CES}	Collector Leakage Current	V _{CE} =330 V, V _{GE} =0 V	114	395		μA	
I _{GES}	Gate Leakage Current	V _{GE} =30 V, V _{CE} =0 V	100	400		nA	
V _{GE(th)}	Gate to Emitter Threshold Voltage (V _{CE})	I _C =250 μA	2.5	3.835	5.5	V	Type 4 V
V _{CE(sat)}	Collector to Emitter Saturation Voltage	V _{GE} =15 V, I _C =40 A, PulseWidth=200 μs	1.044	1.4		V	Type 1.1 V
V _{CE(sat)_L}	Collector to Emitter Saturation Voltage	V _{GE} =15 V, I _C =180 A, PulseWidth=200 μs	1.7468	2		V	Type 1.88 V
V _F	Free-wheeling Diode Forward Voltage	V _{GE} =0 V, I _F =20 A, PulseWidth=200 μs	1.1145	1.6		V	Type 1.2 V
C _{ies}	Input Capacitance	V _{GE} =0 V, V _{CE} =30 V, f=100 kHz	4.1020	5		nF	Type 3880 pF
C _{oes}	Output Capacitance	V _{GE} =0 V, V _{CE} =30 V, f=100 kHz	308.066	500		pF	Type 305 pF
C _{res}	Reverse Transfer Capacitance	V _{GE} =0 V, V _{CE} =30 V, f=100 kHz	176.831	300		pF	Type 180 pF
Q _g	Total Gate Charge	V _{ge(on)} =15 V, V _{ge(off)} =0 V, V _{ce} =200 V	175.731	250		nC	Type 169 nC
Q _{ge}	Gate to Emitter Charge	V _{ge(on)} =15 V, V _{ge(off)} =0 V, V _{ce} =200 V	22.7341	30		nC	Type 22 nC
Q _{gc}	Gate to Collector Charge	V _{ge(on)} =15 V, V _{ge(off)} =0 V, V _{ce} =200 V	72.6221	100		nC	Type 69 nC

Output Characteristics

Transfer Characteristics

Step 10 Printing the datasheet

To print the datasheet, click the printer icon in the preview panel shown in the previous page.

Note: How to print in electric format

- ✓ It is possible to save it in PDF format by installing the printer driver which can print documents in PDF format.
- ✓ XPS (XML Paper Specification) is supported by the operating system, and this capability can also be used.
- ✓

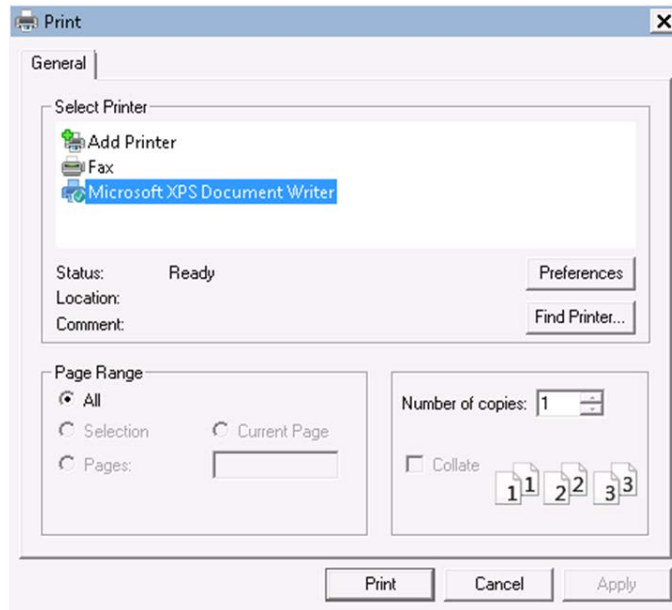

Figure 2-117 shows a sample image of the printed test result of the datasheet characterization mode.

Figure 2-117 Datasheet characterization print example.

Part Number: FGA180N33ATD
Device ID: Sample 1
Description: Fairchild: 330 V, 180 A PDP Trench IGBT



Maximum Ratings						
Symbol	Parameter	Test Conditions	Value	Unit	Note	
VCES	Collector to Emitter Voltage	Tj=-50 °C to 150 °C	330	V		
VGES	Gate to Emitter Voltage	Conitnuous	-30 to 30	V		
ICM	Pulsed Collector Current	Tc=25 °C	450	A		
IFM	Pulsed Freewheeling Diode Current	Tc=25 °C	450	A		

Characteristics Parameters							
Symbol	Parameter	Test Conditions	Min.	Act.	Max.	Unit	Note
BVCES	Collector to Emitter Breakdown Voltage	VGE=0 V, IC=400 µA	330	361.35		V	
ICES	Collector Leakage Current	VCE=330 V, VGE=0 V		71 n	395 µ	A	
IGES	Gate Leakage Current	VGE=30 V, VCE=0 V		100 p	400 n	A	
VGE(th)	Gate to Emitter Threshold Voltage (VCE)	IC=250 µA	2.5	4.159	5.5	V	Typ. 4 V
VCE(sat)	Collector to Emitter Saturation Voltage	VGE=15 V, IC=40 A, PulseWidth=200 µs		1.0256	1.4	V	Typ. 1.1 V
VCE(sat)_1	Collector to Emitter Saturation Voltage	VGE=15 V, IC=180 A, PulseWidth=200 µs		1.8256	2	V	Typ. 1.68 V
VF	Freewheeling Diode Forward Voltage	VGE=0 V, IF=20 A, PulseWidth=200 µs		1.1736	1.6	V	Typ. 1.2 V
Cies	Input Capacitance	VGE=0 V, VCE=30 V, f=100 kHz		4.1317	5 n	F	Typ. 3880 pF
Coes	Output Capacitance	VGE=0 V, VCE=30 V, f=100 kHz		325.05	500 p	F	Typ. 305 pF
Cres	Reverse Transfer Capacitance	VGE=0 V, VCE=30 V, f=100 kHz		182.56	300 p	F	Typ. 180 pF
Qg	Total Gate Charge	Vge(on)=15 V, Vge(off)=0 V, Vce=200 V		166.93	250 n	C	Typ. 169 nC
Qge	Gate to Emitter Charge	Vge(on)=15 V, Vge(off)=0 V, Vce=200 V		24.621	30 n	C	Typ. 22 nC
Qgc	Gate to Collector Charge	Vge(on)=15 V, Vge(off)=0 V, Vce=200 V		70.162	100 n	C	Typ. 69 nC

Output Characteristics

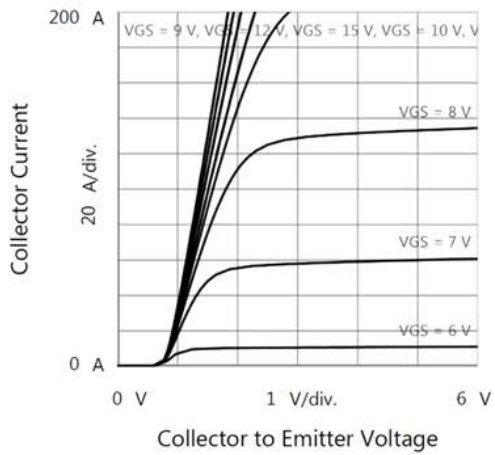

Transfer Characteristics

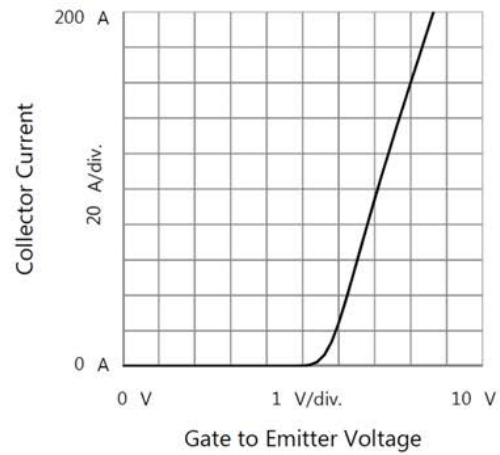

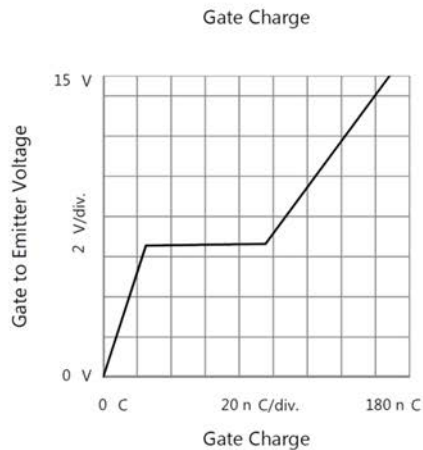
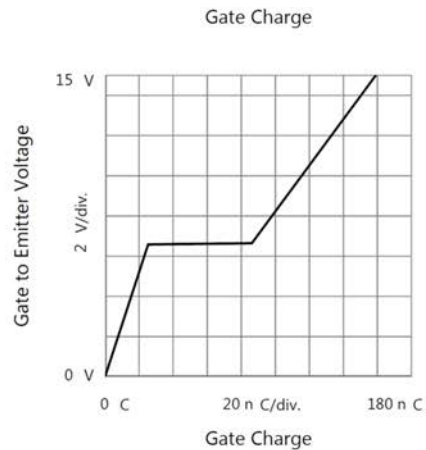
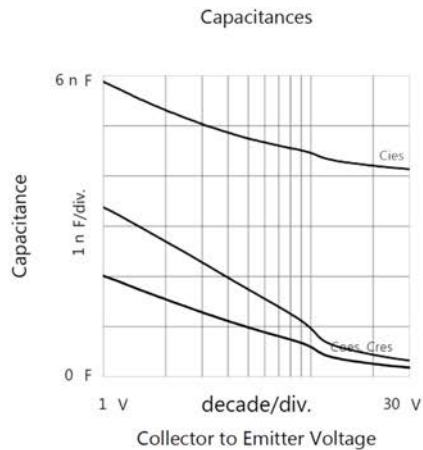
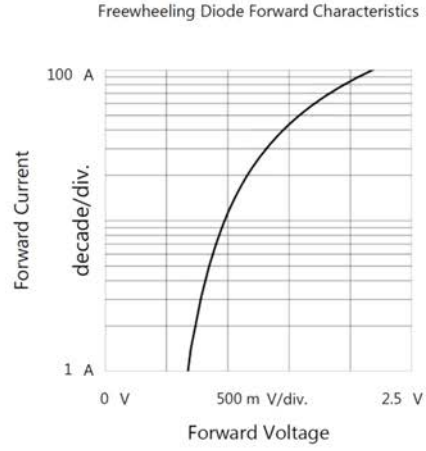
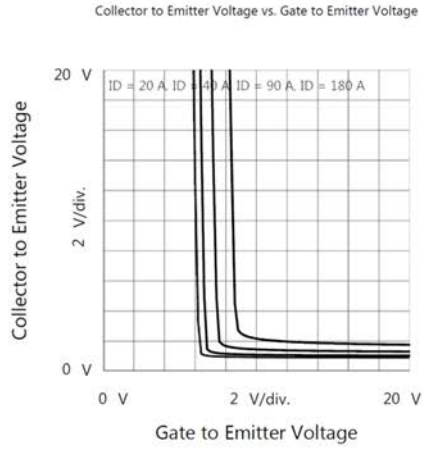

Step 11

Creating a summary report from multiple test result files

Easy Test Navigator has a function to create a summary report from the characteristics parameters of multiple test results called the Datasheet Reporter. The report is saved in a tab separated format. The datasheet reporter has an option to add the minimum value, the maximum value described in the datasheet setup and the unit of the measured value as references (Figure 2-120).

Figure 2-120 shows an example of the report imported into the spreadsheet application.

Figure 2-118 Summary report imported into the spreadsheet application.

DeviceID	PartNum	SampleID	BVCS	ICES	IGES	IGES(-)	VGE(th)	VCE(sat)	VCE(sat)_VFM	Ctes	Coes	Cres	Qg	Qge	Qgc	File
Device-1	FGA180N3	Sample1	371.4	8.80E-08	5.00E-11	0	3.882	1.0409	1.7031	1.1342	4.07E-09	3.13E-10	1.76E-10	1.75E-07	2.30E-08	C:\Users\Public\Document
Device-1	FGA180N3	Sample2	363.003	9.50E-08	5.00E-11	5.00E-11	3.894	1.0444	1.7113	1.1309	4.03E-09	3.15E-10	1.76E-10	1.70E-07	2.27E-08	C:\Users\Public\Document
Device-1	FGA180N3	Sample3	367.992	9.80E-08	5.00E-11	0	3.947	1.0385	1.6978	1.1335	4.03E-09	3.19E-10	1.76E-10	1.70E-07	2.28E-08	C:\Users\Public\Document
Device-1	FGA180N3	Sample4	372.894	9.00E-08	5.00E-11	0	3.872	1.0428	1.7158	1.1369	4.08E-09	3.11E-10	1.77E-10	1.78E-07	2.32E-08	C:\Users\Public\Document
Device-1	FGA180N3	Sample5	372.756	9.40E-08	5.00E-11	0	3.835	1.0422	1.7123	1.1342	4.08E-09	3.11E-10	1.77E-10	1.78E-07	2.32E-08	C:\Users\Public\Document

The report consists of the device ID, part number, sample ID and file name of each datasheet setup in addition to the measured characteristics parameters.

To create the summary report, follow the steps described below and refer to Figure 2-119.

1. Select "Report" from the menu to launch the datasheet reporter
2. Click the "Add" button
3. Select datasheet result files
4. Click the "Open" button
5. Test result files are imported to the datasheet reporter
6. Click the "Execute" button
7. Input the file name of the report to be created
8. Click the "Save" button

Figure 2-119 Creating a summary report using the datasheet reporter.

(a) Importing the test result files to the datasheet reporter

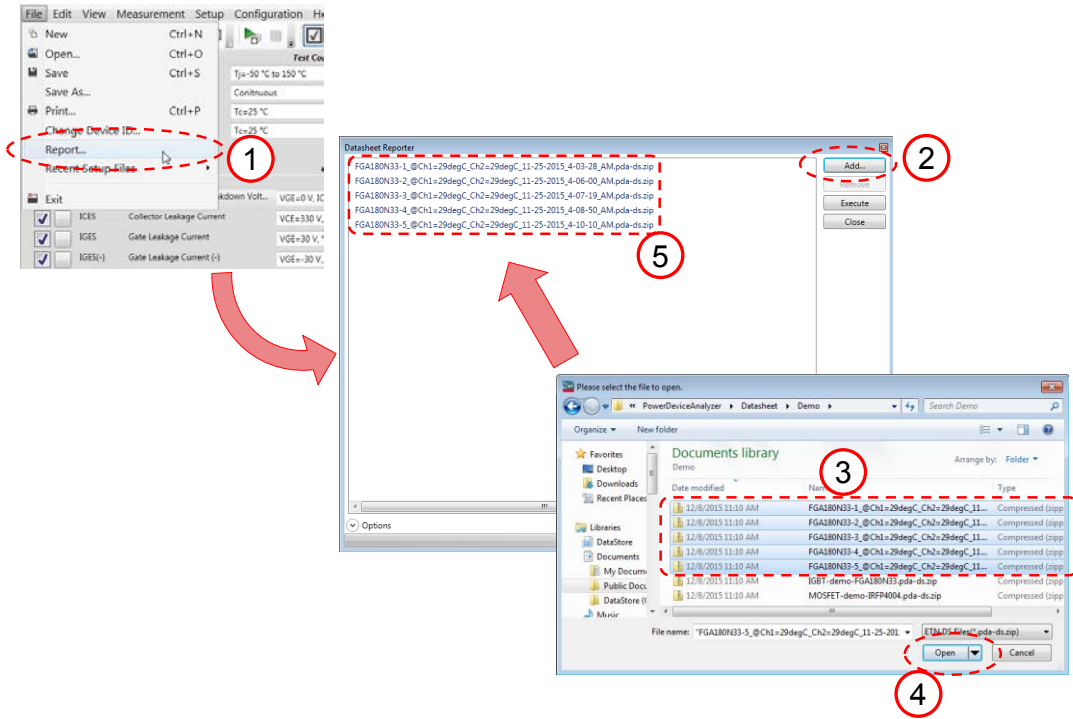

(b) Creating the report from the imported test results

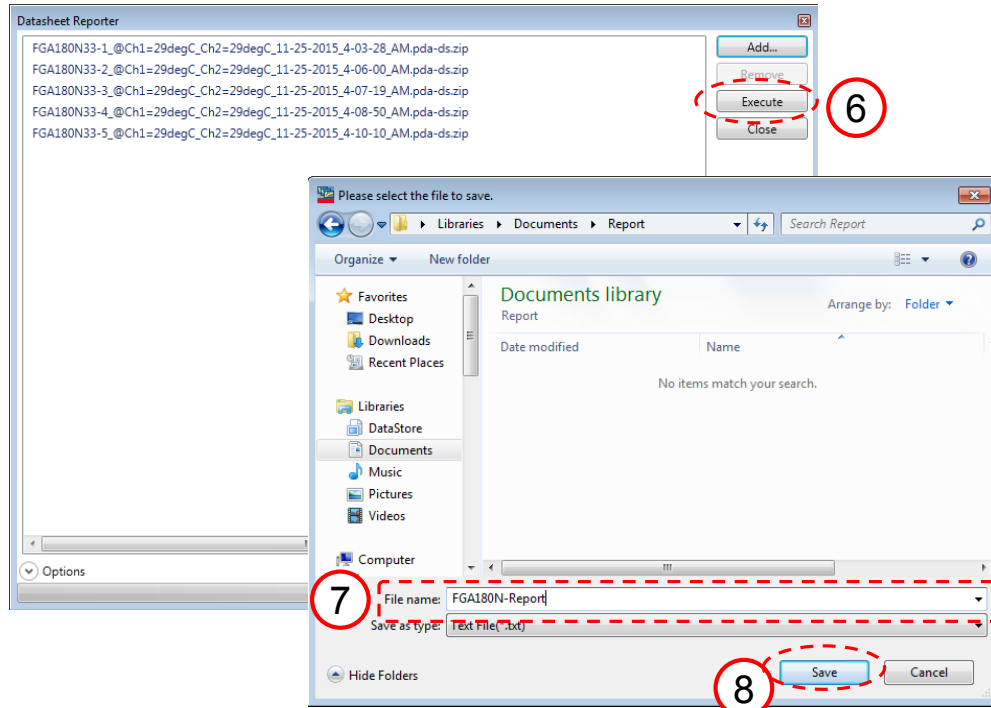

The datasheet reporter has an option to add the minimum value, the maximum value described in the datasheet setup and the unit of the measured value as references (Figure 2-120).

Figure 2-120 Datasheet reporter option

(a) Reporting option to add min., max. and unit of the value

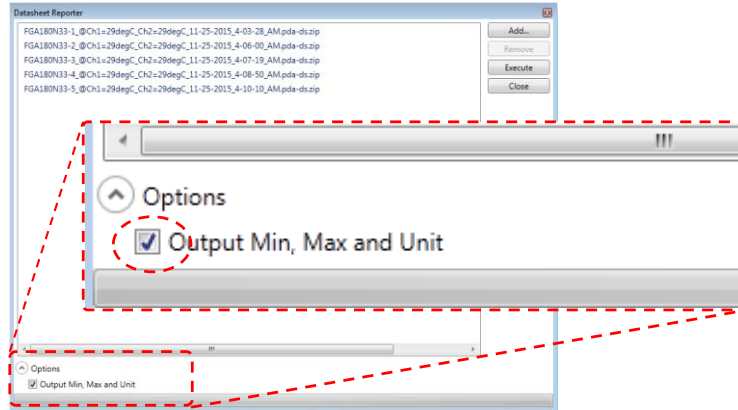

(b) Output report

DeviceID	PartNum	SampleID	BVCEs	ICES	IGES	IGES(-)	VGE(th)	VCE(sat)	VCE(sat)	VFM
		Min	330			-4.00E-07	2.5			
		Max		0.0004	4.00E-07		5.5	1.4	2	1.6
		Unit	V	A	A	A	V	V	V	V
Device-1	FGA180N3	Sample1	371.4	8.80E-08	5.00E-11	0	3.882	1.0409	1.7031	1.1342
Device-1	FGA180N3	Sample2	363.003	9.50E-08	5.00E-11	5.00E-11	3.894	1.0444	1.7113	1.1309
Device-1	FGA180N3	Sample3	367.992	9.80E-08	5.00E-11	0	3.947	1.0385	1.6978	1.1335
Device-1	FGA180N3	Sample4	372.894	9.00E-08	5.00E-11	0	3.872	1.0428	1.7158	1.1369
Device-1	FGA180N3	Sample5	372.756	9.40E-08	5.00E-11	0	3.835	1.0422	1.7123	1.1342

If the test result files of different devices are imported to the datasheet reporter, the minimum and the maximum value of the first file are used as the minimum and the maximum value of the report.

Useful information for using the datasheet characterization mode

Tips to customize a datasheet setup

Tips: **How to change the picture of the device**

It is possible to replace or remove the picture of the device. Right click the image and select an action from the pop-up menu.

- ✓ The imported picture is used when printing out the measured result.
The PNG, BMP and JEPEG format can be imported.

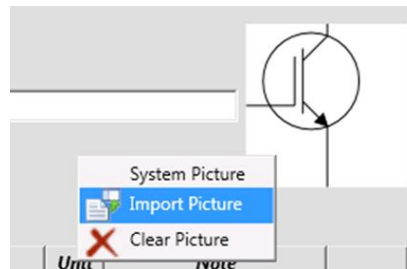

Tips: **How to change the symbol name and the description**

If the symbol name or description of a parameter are different from the datasheet and it is necessary to use the same symbol as the datasheet, it is possible to modify them.

- ✓ Click the symbol name or parameter field, and then modify them.

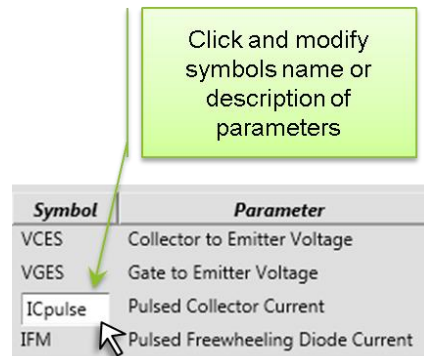

Tips: How to add a new item to the maximum ratings

To add a new item to the list of maximum ratings,

1. Right click the mouse and select “Add MaximumRating” from the popup menu, or select the icon to add maximum ratings in the ribbon menu.
2. Define the symbol, type of value (point or range), value and unit of the item.
3. Click “OK” to save the item.

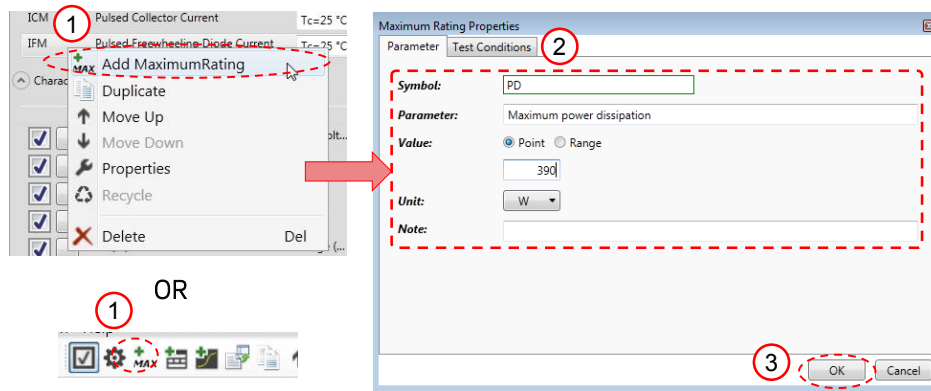

Tips: How to add the minimum / maximum limit to the characteristics parameters

It is possible to add the minimum/maximum limit to the parameters. For example, normally, only the minimum value is defined for BVCES in the datasheet. But, it is possible to add a maximum limit in addition to the minimum limit. To add the maximum or minimum limit, click the blank area under the “Max.” or “Min.” labels, and the input box appears.

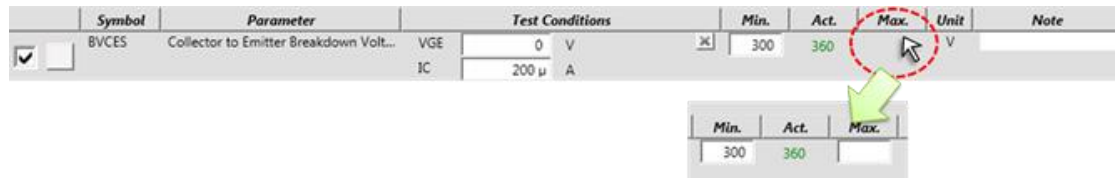

Note:

- ✓ If both the maximum and minimum rating are not defined, pass/fail judgment is not done at the measurement.
- ✓ Some of the parameters do not allow you to leave both the Min. and Max. values blank (ex. Vce(sat)) because those are associated with the detailed setup of the measurement (ex. current or voltage compliance).
- ✓ To delete the limit associated with the detailed setup, it is necessary to release the association between the limit and the setup (Refer to “Tips: How to change the association of the test conditions with the measurement setup”).

Tips: How to change the association of the test conditions with the measurement setup

The test conditions, the min. and the max. limits of the characteristics parameters are associated with the measurement setup via the properties of each item. For the characteristics graphs, the range and scaling mode of the X and Y axes are associated with the measurement setup via its properties.

To access to the properties of the item, right click the item and select “Properties” in the popup menu, or select the item and click the properties icon in the ribbon menu.

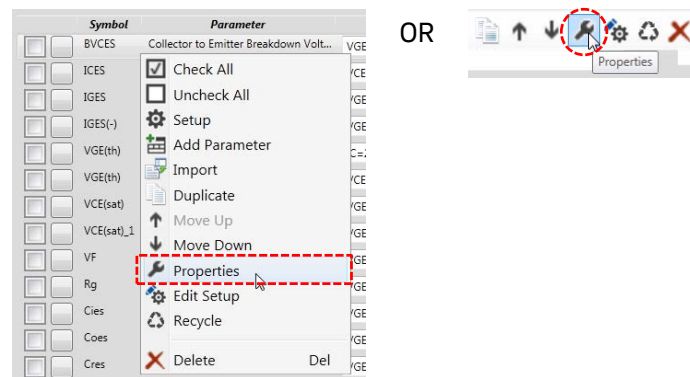
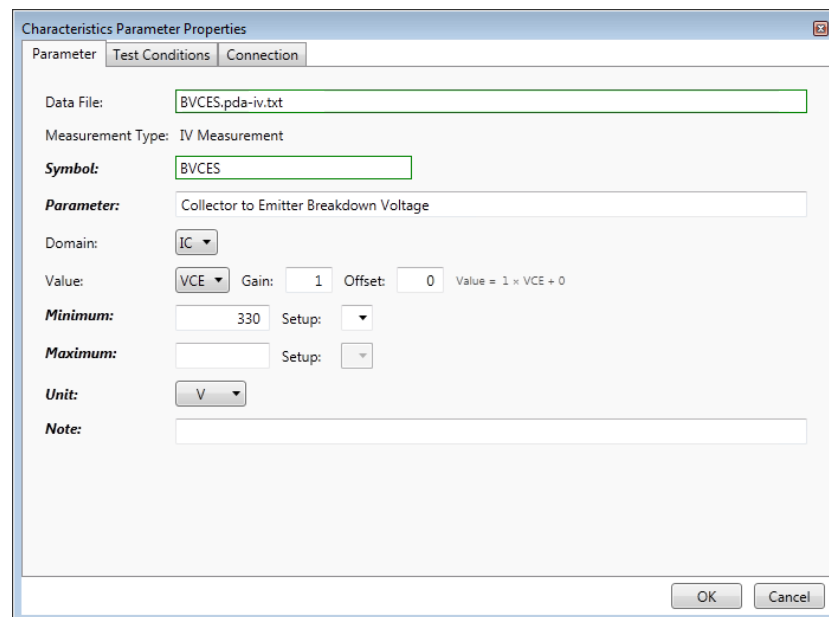

Figure 2-121 shows the parameters in the properties of the BVCES measurement

Figure 2-121 Basic parameters of properties



Data file: name of setup file for the BVCES measurement included in the datasheet setup file.

- ✓ Symbol: symbol of the item
- ✓ Parameter: description of the item
- ✓ Domain: Primary sweep parameter of the setup. In the BVCES measurement, the specified collector current is applied to the device to measure the BVCES.
- ✓ Value: Retuned value from the setup
- ✓ Minimum: the minimum limit of the item. Association is described at the "Setup:". In this case, the setup is blank and there is no association with the setup. If it is necessary to limit the maximum voltage applied to the device, specify the parameter in the measurement setup as "Setup:". For example, to limit the voltage applied to the device at 1.5 of the minimum limit, select the "Drain / Collector > Current Staircase Sweep > Compliance" as the setup associated with the minimum value, and set 1.5 as gain (Figure 2-122).

Figure 2-122

Example of association of the max./min. value with the setup

The screenshot shows a control panel for a 'Minimum' parameter. It includes a text input field with the value '330', a dropdown menu for 'Setup' currently showing 'Drain / Collector > Current Staircase Sweep > Compliance', a 'Gain' input field with '1.5', and an 'Offset' input field with '0'. Below these fields, a calculation is displayed: '--Compliance = 1 x 330 + 0'.

In this case, 495 V is set as the compliance value in the measurement setup. If the association is defined, the limit value cannot be removed from the datasheet setup of the item. To remove the association, select a blank from the pull down list at the "Setup:".

- ✓ Maximum: the maximum limit of the item.
- ✓ Unit: unit of the value

Figure 2-123 shows an association of test conditions with the measurement setup.

Possible input value as VGE is limited at VGES by associating with VGES described in the maximum rating section. To remove the limit to the input value, select blank from the pull down list of the rating symbol.

Specified VGE is input as the gate source value of the measurement setup as is (Figure 2-123 (a)).

Also, the specified IC is input as the collector current force value(Figure 2-123 (b)).

Figure 2-123 Example association of test conditions with the measurement setup

(a) Association of VGE in the test conditions

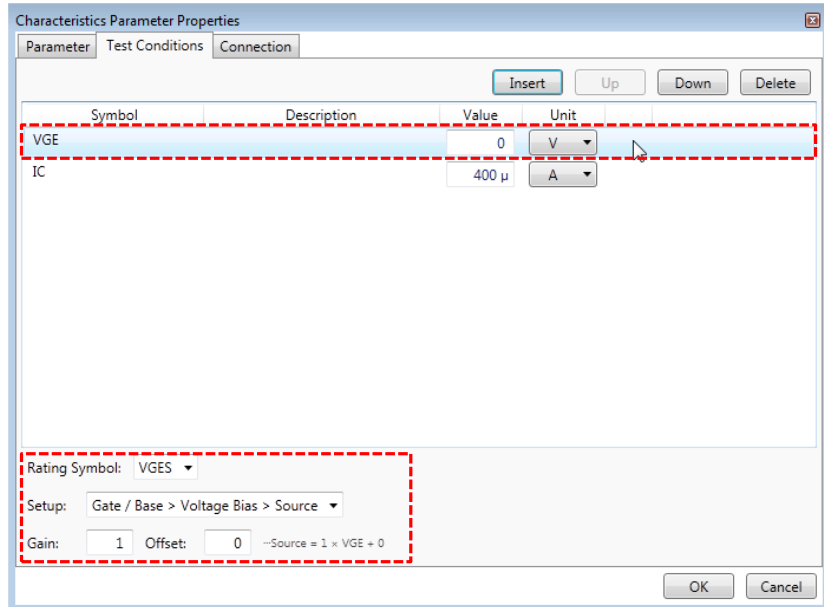

(b) Association of IC in the test conditions

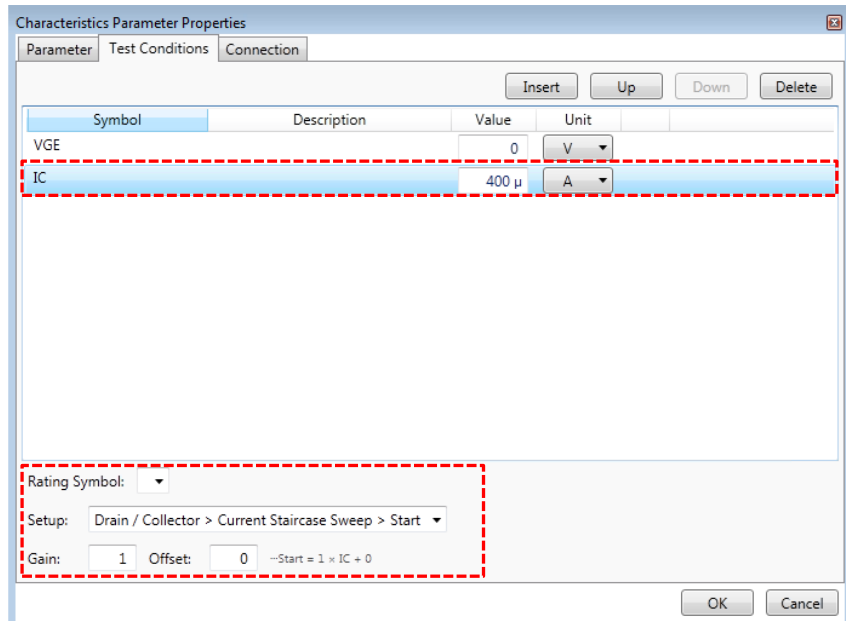

For the items in the characteristics of graph, refer to “Tips: How to create a new item by modifying the existing item”.

Tips: How to delete the items

It is possible to delete unnecessary items to make the datasheet setup the same as the exact datasheet of the device to be measured. For more details, refer to “**Tips: How to delete the existing item**” in section “**5.5 VGE(th) with constant VCE**”.

Tips: How to restore the deleted items

The deleted items are stored in the recycle bin. To restore them, open the recycle bin by right-clicking the datasheet and select “Recycle” from the pop up menu, or click the “Recycle” mark in the ribbon menu (Figure 2-124).

Figure 2-124 **Displaying the items stored in the recycle bin**

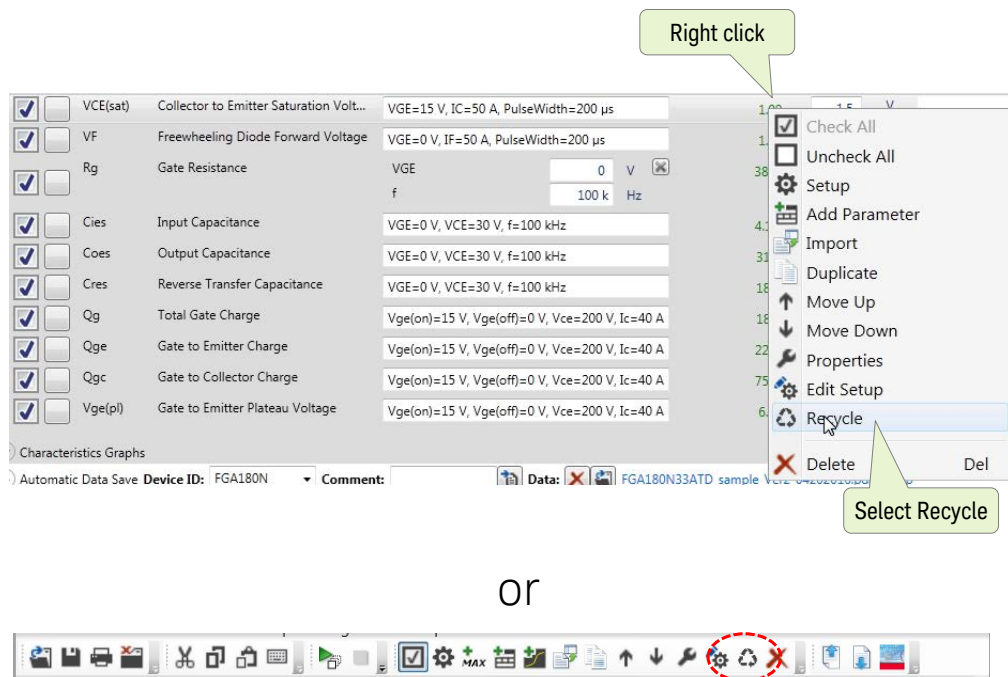

Then select the item to be restored, click the “Restore selected item” button and it will be restored to its original position (Figure 2-125).

Figure 2-125 Restoring deleted items in the recycle bin

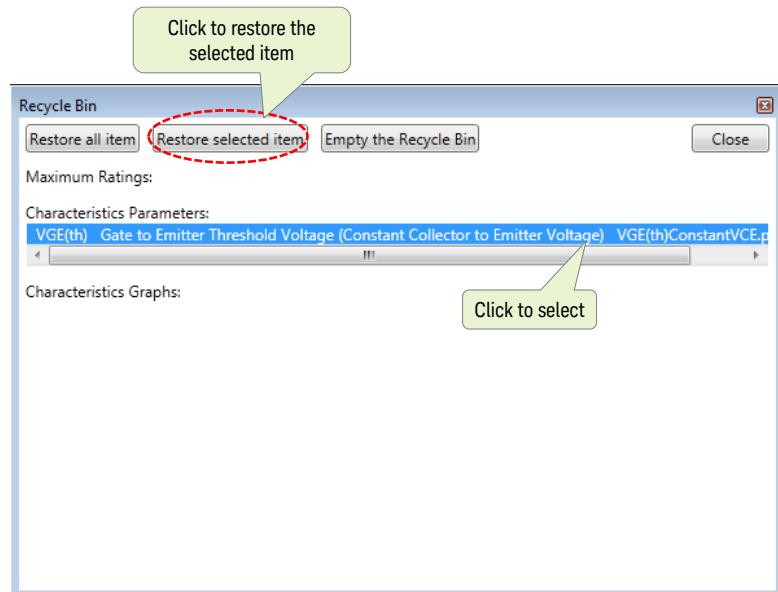

The deleted items are stored in the recycle bin. The items in the recycle bin are kept until a new setup is created, the existing setups are imported or the recycle bin is emptied.

Tips: **How to duplicate the existing setup**
 It is possible to duplicate the existing setup to add items measured with different test conditions. For more details, refer to “**Tips: How to duplicate the existing test setup**” in section “**VCE(sat) test conditions for IC=180 A**”.

Tips: **How to change locked parameter in the setup**
 Some of parameters in the IV, CV or Qg measurement cannot be changed to prevent unexpected measurement errors due to mismatch in usage. To change those locked parameters to modify the existing setup, use “Edit Setup” instead of “Setup”. For more details, refer to “**Tips: How to measure IC-VGE characteristics under the threshold region**” as an example.

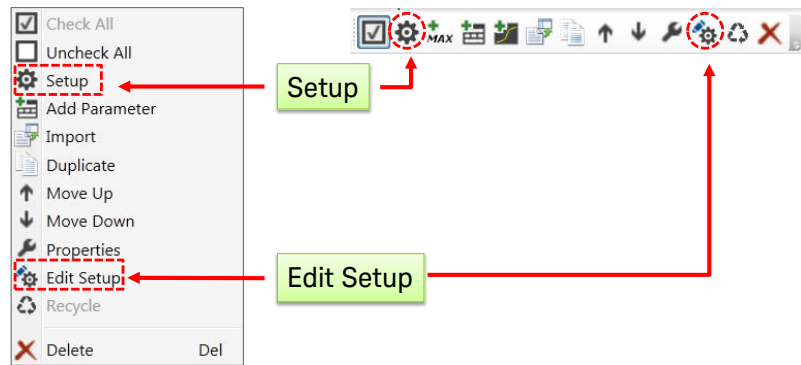

After modifying the setup, it is often necessary to change the properties of the item in the datasheet setup (refer to “**Tips: How to change the association of the test conditions with the measurement setup**”).

Tips:

How to create a new item by modifying the existing item

It is possible to add a parameter not included in the initial template of each device type. There are two methods to add a new parameter to the datasheet setup.

- ✓ Duplicating and modifying an existing parameter
- ✓ Creating a new parameter

If a similar parameter already exists, the first method is easier. For example, creating gfs characteristics can be created by modifying the existing setup of the IC-VGE template as described in section “**5.6 Transconductance (gfs)**”.

As another example, to add a collector breakdown characteristics graph, the setup of the IC-VCE output characteristics graph can be used as a template. The steps to create the setup of collector breakdown characteristics from the setup of IC-VCE output characteristics are as follows:

1. Duplicate the setup of the IC-VCE characteristics.



2. Modify the title of the duplicated setup to “Collector Breakdown Characteristics”.
3. Open the setup by selecting “Edit Setup”.

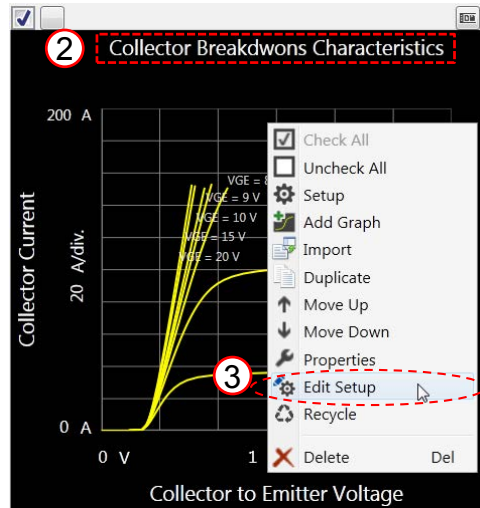

4. Change the collector bias settings.
 - ✓ Module: UHVC to HVSMU
 - ✓ Output mode: VPulse to V
 - ✓ Number of Step: 21 to 101
5. Change the gate bias settings.
 - ✓ Output mode: VPulse to V
 - ✓ Output sequence: Step to Constant
6. Set the general settings.
 - ✓ Trace mode: Fine
 - ✓ NPLC: 1
 - ✓ Delay Time: 100 ms

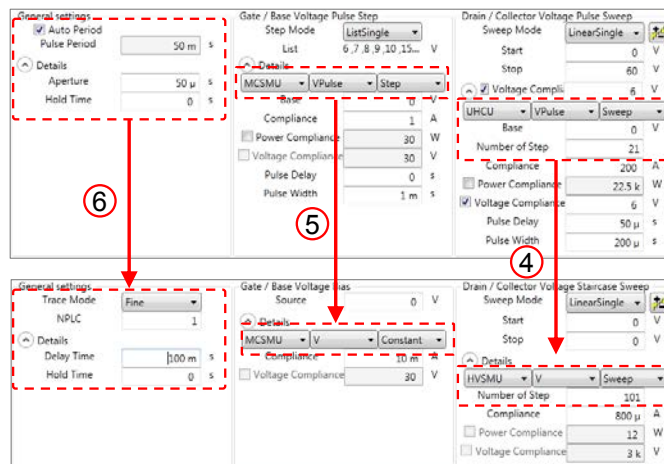

7. Save before exiting the setup.
8. Exit from the setup.

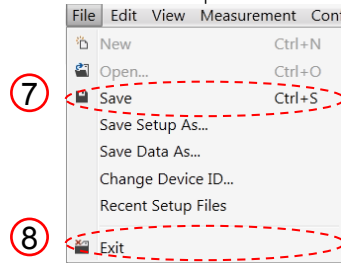

9. Click the “OK” button of the confirmation window to modify the properties of the setup to fix the mismatch between the properties and the measurement setup.

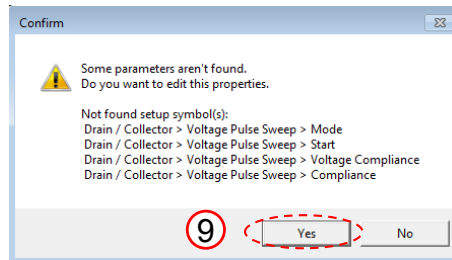

10. Change the setup associated with the X axis scaling mode to “Drain / Collector > Voltage Staircase Sweep > Mode”.
11. Change the setup associated with the minimum value of the X axis to “Drain / Collector > Voltage Staircase Sweep > Start”.
12. Change the setup associated with the maximum value of the X axis to “Drain / Collector > Voltage Staircase Sweep > Stop”.
13. Change the rating symbol associated with the X axis to bank to release the limit of the X axis.
14. Change the setup associated with the maximum value of the Y axis to “Drain / Collector ¥ > Voltage Staircase Sweep > Compliance”.
15. Click the “Save” button.

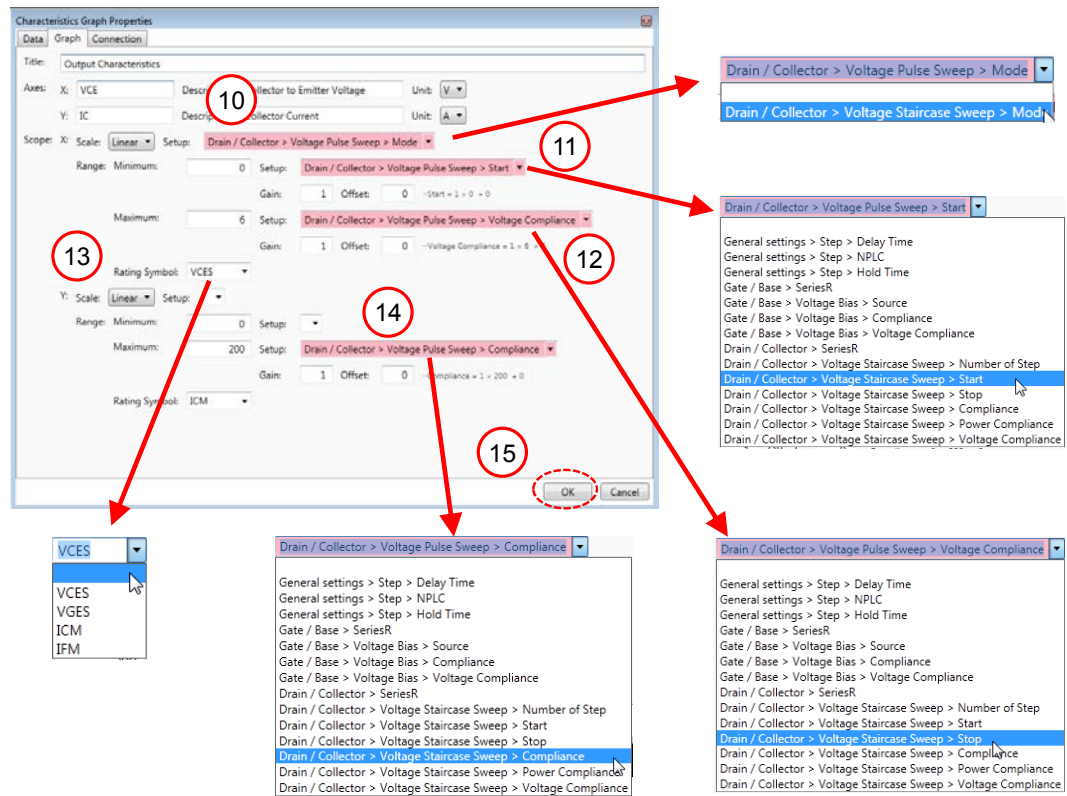

16. Change the maximum value of the X axis to 400 V and the Y axis value to 400 μ A.
17. Run the setup and the graph will be updated.

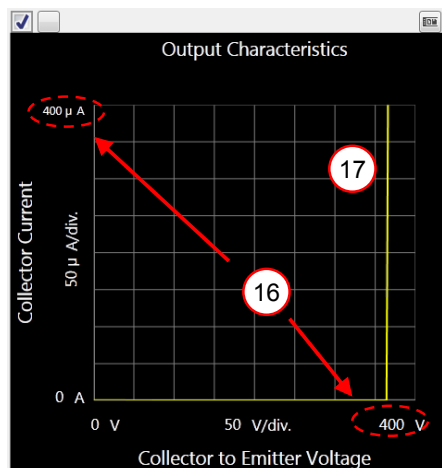

Note: Without releasing the association between the rating symbol (VCES) to the X axis, the possible maximum value is limited by the VCES defined in the maximum rating section (ex. 330 V).

Tips:

How to create a new item from the measurement setup

It is possible to create a new item from an individual IV, CV or Qg measurement setup by using “Add Parameter” or “Add Graph”.

The steps to create a new item from the measurement setup are,

- ✓ Create a measurement setup using IV, CV or Qg measurement mode
- ✓ Import the measurement setup using the “Add Parameter” or “Add Graph” function in the datasheet mode.
- ✓ Define the properties of the newly added item

At this point, try to add RCE, collector to emitter resistance to the characteristics parameter section.

Create a measurement setup of a single point RCE measurement

1. Launch the IV measurement mode.

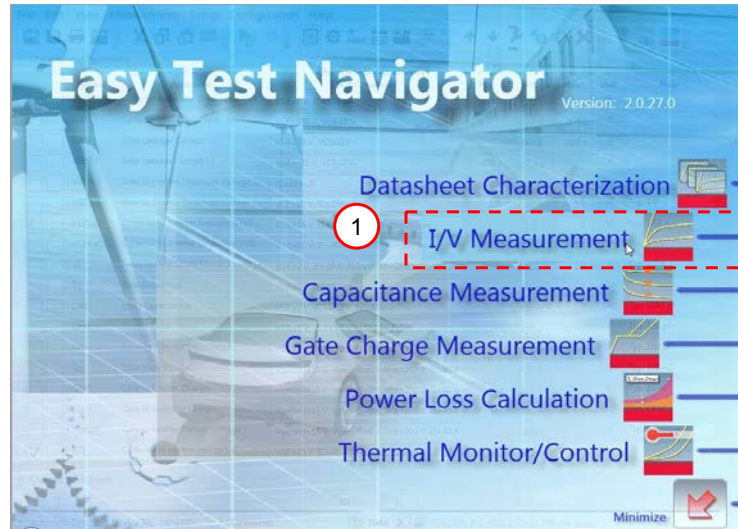

2. Select MOS-FET as a device type because on-resistance measurement is not available for IGBT device type.
3. Select RDS-VGS template
4. Modify the drain/collector current pulse sweep setup as follows;
 - ✓ Number of step: 1
 - ✓ Pulse width: 200 μ s
 - ✓ Start: 40 A (for checking purpose)
5. Modify the gate / base bias setup as follows;
 - ✓ Output mode: V
 - ✓ Output sequence: Constant
 - ✓ Source: 15 V (for checking purpose)
6. Click the measure button to check the setup.
7. Confirm that the measured value is reasonable.

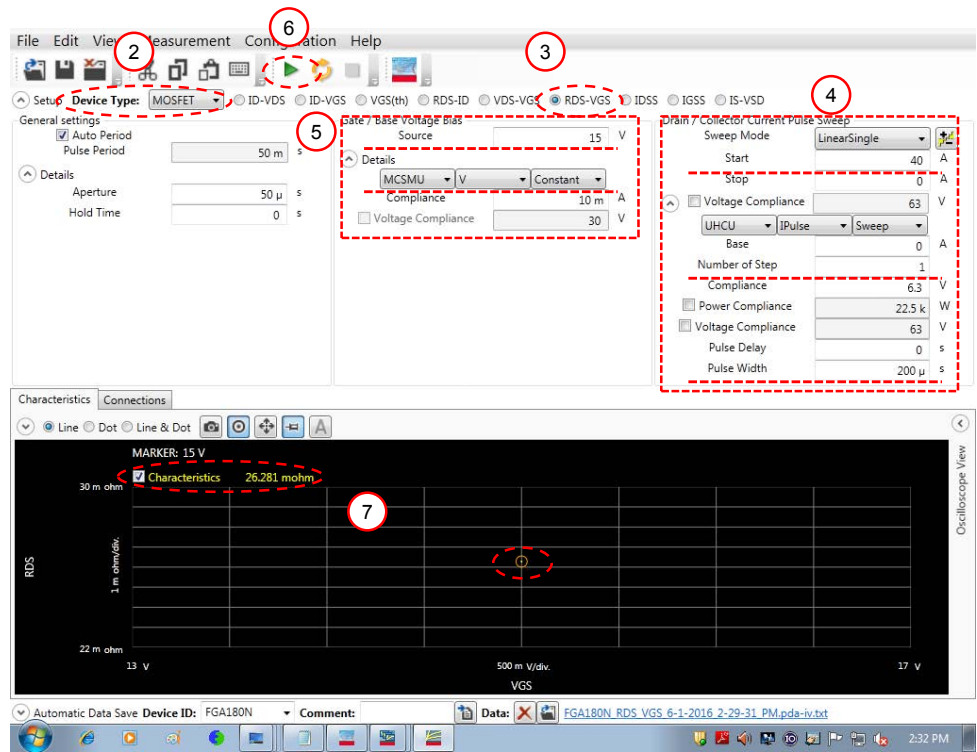

Note: Only the parameters supported by each device type can be used as an output value (refer to Figure 2-126).

Figure 2-126 Available measurement parameters of MOS-FET and IGBT

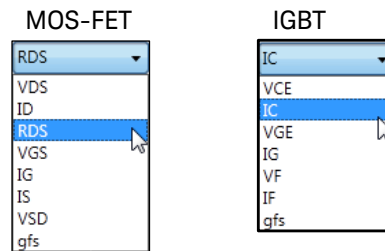

8. Click the “Save Data As...” button

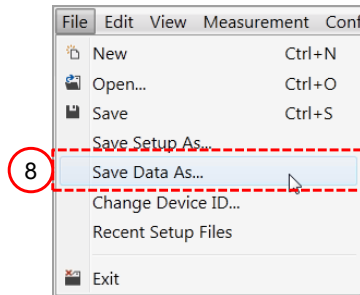

9. Type the file name of the setup
10. Click the “Save” button to save the setup

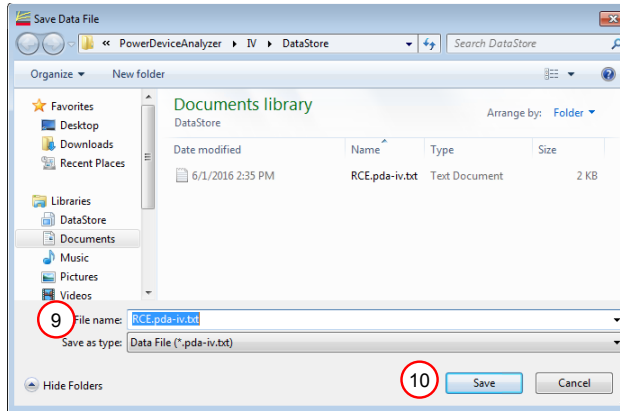

Import the setup of RCE to the datasheet

11. Right click the characteristics parameter area and select “Add Parameter”, or click the “Add Characteristics Parameter” icon in the ribbon menu.

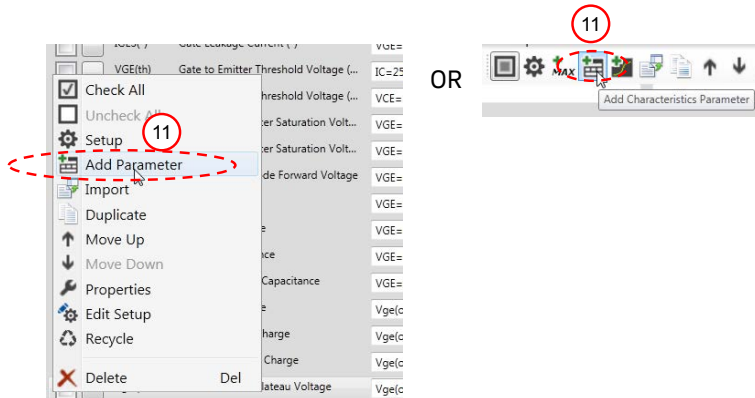

12. Select the setup file of the RCE measurement.
13. Click the “Open” button.

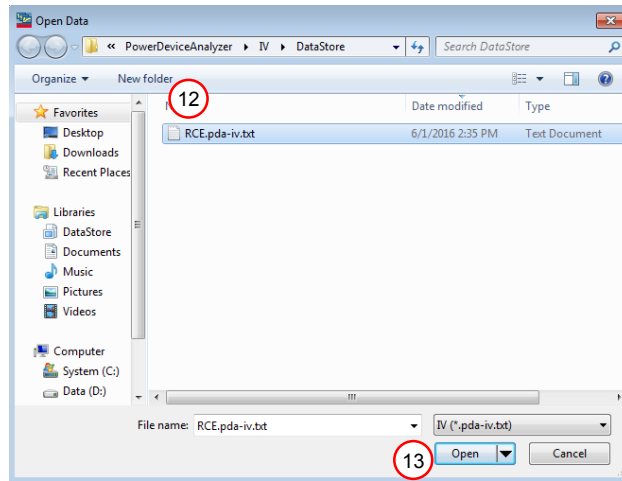

Define the properties of RCE measurement

14. Edit the items in the parameters of the properties as follows;
 - ✓ Symbol: RCE
 - ✓ Parameter: Collector to emitter resistance
 - ✓ Domain: VGS
 - ✓ Value: RDS
 - ✓ Gain: 1
 - ✓ Offset: 0
 - ✓ Maximum 50 m
 - ✓ Unit: ohm

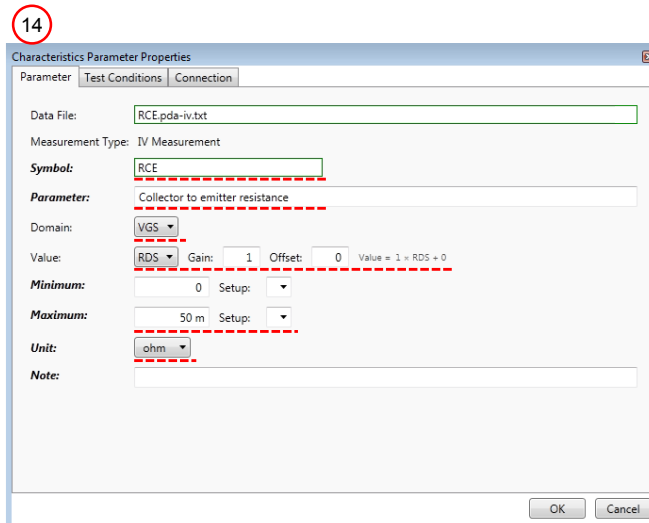

15. Insert test conditions by clicking the “Insert” button in the “Test Conditions” tab.

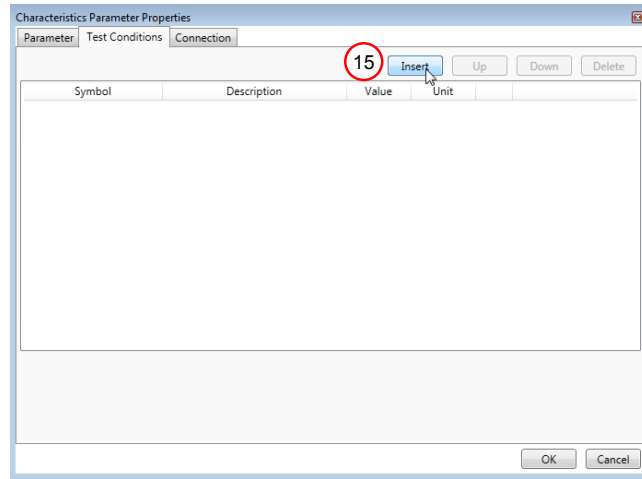

16. Edit the added test conditions as follows;

- ✓ Symbol: IC
- ✓ Description: Collector current
- ✓ Value: 40 A
- ✓ Unit: A
- ✓ Rating Symbol: ICM
- ✓ Setup: Drain / Collector > Current pulse Sweep > Start

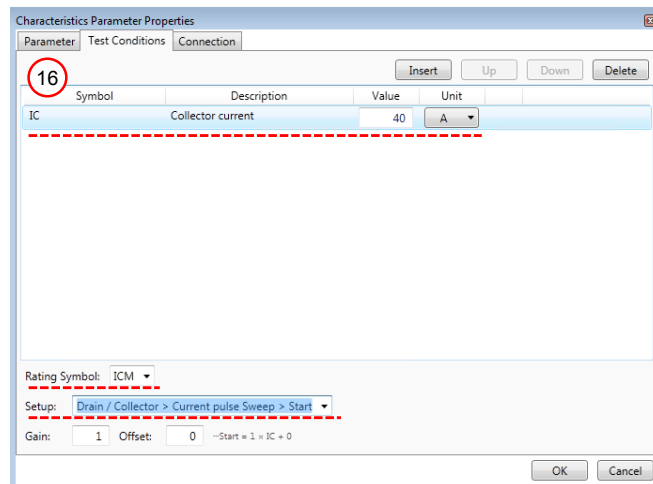

17. Insert another test condition and edit it as follows:

- ✓ Symbol: VGE
- ✓ Description: Gate to emitter voltage
- ✓ Value: 15
- ✓ Unit: V
- ✓ Rating Symbol: VGES
- ✓ Setup: Gate / Base > Voltage Bias > Source

18. Click the “OK” button

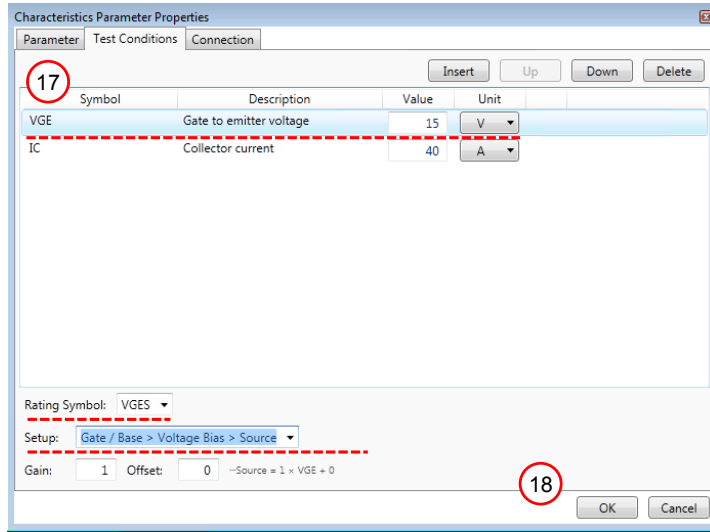

19. RCE is added to the characteristics parameters area as a new item

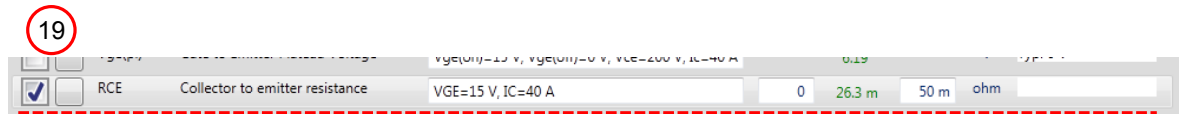

Tips:

How to import the data from the other measurement setup

It is possible to import the measurement data of an IV, CV or Qg measurement as the data of the existing item in the datasheet. To import the data, right click the item and select “Import” from the popup menu, or select the item and click “Import” icon in the ribbon menu.

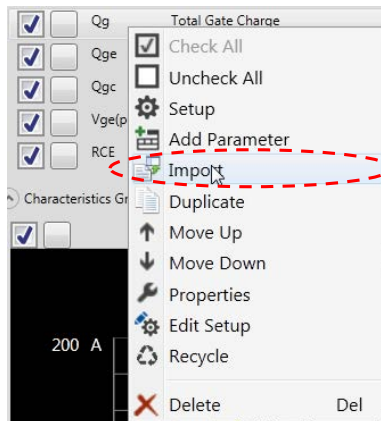

OR

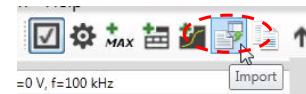

To import the data, the type and definition of the setup should be the same as the item. For example, to import data to BVCES, the data should be measured by using the setup of BVCES too.

Tips:

How to merge the data of different datasheet setups

By using the import function, it is possible to merge multiple datasheets. The datasheet set file is a zipped archive consisting of IV, CV and Qg measurement data files. By extracting it, it is possible to access the data file of each item. By importing the data file of the other datasheet files, it is possible to merge multiple datasheet files into a single datasheet file.

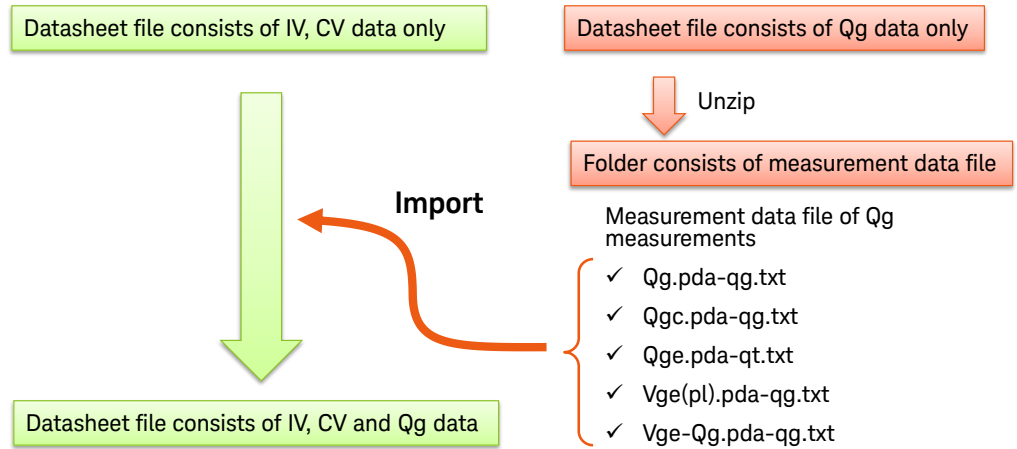

Tips:

How to change the connection diagram

It is possible to change the diagram displayed in the connection confirmation window. It is defined in the property of each parameter item. Refer to “**Method 3: Changing the picture of the connection**” in section “**Step8 Run a test of the entire parameters and graphs**” as an example.

Tips:

How to change the order of the measurement

It is possible to change the order of the measurement in the datasheet setup. Refer to “**Tips: How to change the order of the measurement**” in section “**Step8 Run a test of the entire parameters and graphs**”.

Tips:

How to skip the specified item

To skip the measurement of specified items, uncheck the items by clicking the check box of the item.

Click the box to toggle the check of the item

	Symbol	Parameter	
<input type="checkbox"/>	BVCES	Collector to Emitter Breakdown Volt...	VGE=0 V
<input checked="" type="checkbox"/>	ICES	Collector Leakage Current	VCE=330
<input checked="" type="checkbox"/>	IGES	Gate Leakage Current	VGE=30 V
<input checked="" type="checkbox"/>	IGES(-)	Gate Leakage Current (-)	VGE=-30

It is possible to check or uncheck all items at once as follows:

- ✓ Right click the item and select “Check All” or “Uncheck All” from the popup menu, or
- ✓ Click the “All Check/Uncheck” icon in the ribbon menu

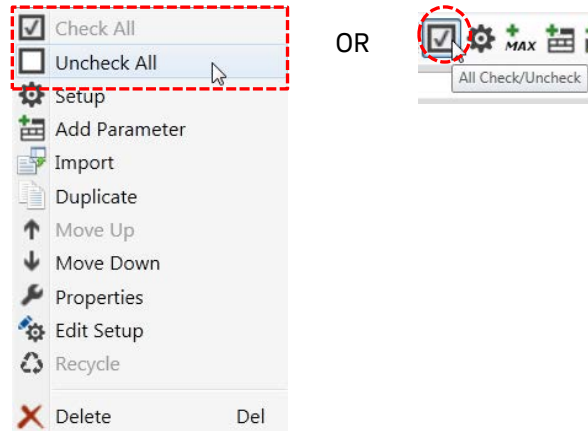

Tips: How to measure IV, CV and Qg at the specified temperature using the Thermal Monitor/Control function

By combining the skip function and the “without data cleared” measurement option (refer to “**Measurement options**” in “**Step 8 Run a test of the entire parameters and graphs**”), it is possible to separate measurement of the single datasheet setup into two stages.

For example, in the case of temperature dependence measurement including IV, CV and Qg measurement, it is not possible to do it at once because it is necessary to switch the adapter from the IV and CV to the Qg measurement. First, perform IV and CV measurement only by removing the checks from the items of Qg measurement at the specified temperature. After reverting back to the room temperature, change the adapter to the Qg test adapter and measure the remaining Qg items only at the specified temperature by using the same datasheet setup with the “without data cleared” option. After finishing the measurement of the Qg items, measured values of IV, CV and Qg are stored into the single datasheet setup.

Tips: How to stop the measurement when the result exceeds the limits

It is possible to skip consequent items if the measured result exceeds the specified minimum/maximum limits. For more details, refer to “**Measurement options**” in “**Step 8 Run a test of the entire parameters and graphs**”.

The UHCU details and measurement tips

How to set the UHCU's V/I parameters for the VCE(sat)

In the UHCU, the output current is determined by the setting voltage of the internal bias source (V_{set}), output resistor and resistance of the DUT as shown in Figure 2-127.

The VCE(sat) current force mode setting:

The key UHCU operations for successful setup of the VCE(sat) test parameters are explained using the numbers shown in the figure.

1. $V_{set} > V_{CE} + V_{drop}$ by R_{out}
Actual voltage applied to the DUT depends on the IC (a. in the figure).
Due to the voltage drop at the output resistor (b.), the voltage actually applied to the DUT ($V_{CE} - c.$) varies by the change of the collector current (IC).
Therefore, V_{set} (d.) must add the voltage drop by the R_{out} resistor on the required VCE, as $V_{set} > V_{CE} + V_{drop}$ by R_{out}
2. VCE is measured accurately by the sense line
The sense terminals of the UHCU have a separate voltage meter from the internal bias source, and actual VCE is measured by the UHCU during the measurement to capture the relationship between VCE and IC.
3. Current pulse is accurate (under the condition of $V_{set} > V_{CE} + V_{drop}$ by R_{out} is satisfied)
When the UHCU is operated in I Pulse mode, the setting voltage of the internal bias source is adjusted* to make the output current same as the specified value by the feedback from the current meter in the UHCU.

Note:

The adjustment is made in real time within single pulse. There is no multiple pulse outputs for adjusting the voltage.

4. Set "Compliance" voltage $> V_{CE} + R_{out} \times IC$
"Compliance" voltage defines the upper limit of the setting voltage during the current meter to V_{set} feedback. If the compliance is not high enough (i.e. Compliance $< V_{CE} + R_{out} \times IC$), the output current does not reach the specified level.
If the compliance is 20 V and 500 A range is used, maximum current is limited to $20 \text{ V} / 120 \text{ m}\Omega = 167 \text{ A}$ when the output voltage is 0 volts.

Note:

The "Voltage Compliance" limits the voltage applied to the DUT (VCE) in the voltage force mode. Once the voltage measured by the voltage meter of the UHCU exceeds the compliance voltage, for example high V_{set} voltage to output high current but actually low IC condition, the remaining pulse steps of the primary sweep are skipped to protect the DUT by applying the over voltage.

Figure 2-127

Relations with the simplified UHCU's internal measurement resources and the VCE(sat) test conditions for IC=40 A.

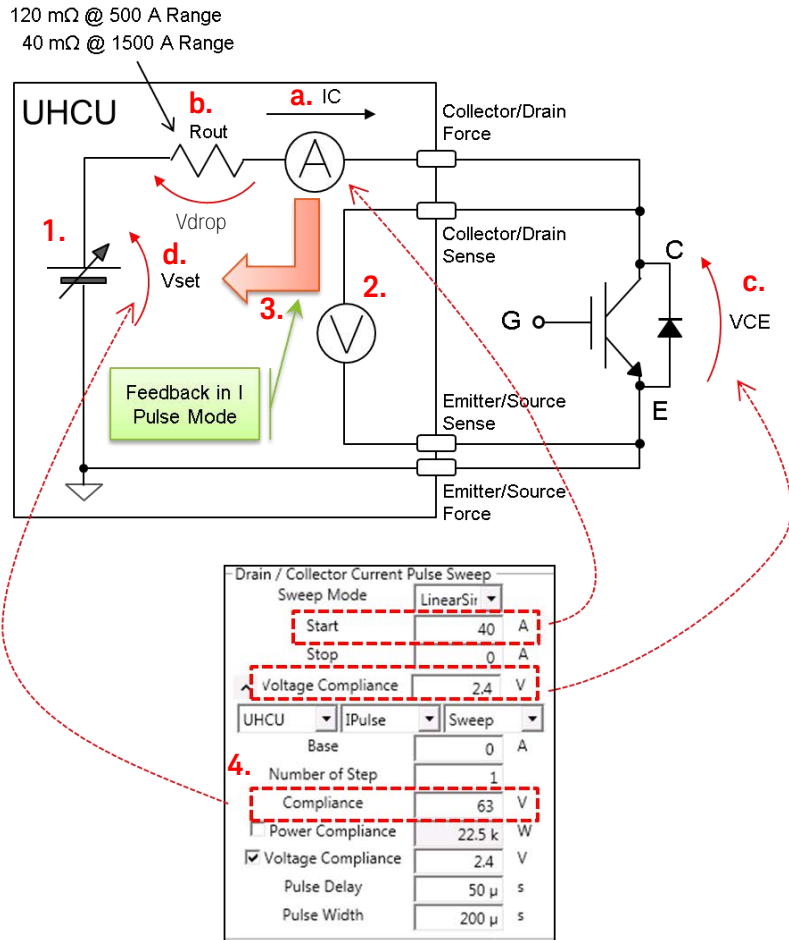

How to set the voltage force mode setup

To set up V_{set} for voltage force mode setup, the following equation is used to set the minimum V_{set} value.

$$V_{set} > (\text{max. } V_{out}) + (\text{current compliance}) \times R_{out}$$

In the following condition, for example, minimum V_{set} is calculated as shown next.

Example 1:

- Output voltage: 10 V
- Current compliance: 1000 A
- R_{out} : 40 m Ω (determined automatically when 1000 A is maximum output current (I compliance))

$$V_{set} > 10 \text{ V} + 1000 \text{ A} \times 40 \text{ m}\Omega = 50 \text{ V}$$

Example 2:

In the case where,

- Output voltage: 10 V
- Current compliance: 100 A
- R_{out} : 120 m Ω (determined automatically when 100 A is maximum output current (I compliance))

$$V_{set} > 10 \text{ V} + 100 \text{ A} \times 120 \text{ m}\Omega = 22 \text{ V}$$

The IC-VGE output characteristics measurement using the UHCU

The basic of IC-VGE measurement uses constant collector voltage. When UHCU is used as the collector supply, the collector voltage varies depending on the collector current due to the voltage drop caused by the output resistor as shown by "b" in Figure 2-127.

To measure IC-VGE (or ID-VDS) at higher current, Ic-Vge for Expanders (or Id-Vgs for Expanders) application of EasyEXPERT is useful. These applications keep the UHCU's output voltage at a constant voltage by using a program based feedback loop.

In the case of the Datasheet Characterization mode, there is no feedback loop, and the voltage, dropped by the output resistor, is applied to the DUT directly.

Next section explains what happens if the VCE is set without considering the voltage drop by the output resistor.

What happens if VCE= 20 V is set, which is a measurement condition:

Figure 2-128 shows an example of the simulated VCE at the DUT when the IC-VCE measurement is made with the UHCU Vset =20 V. In this case, the actual VCE becomes close to the ON voltage of the IGBT, and the IC is saturated at a much lower VGE, and the output characteristics curve apart from the expected curve.

The VCE set voltage of UHCU must be set higher as shown in the previous part.

Figure 2-128

IC-VCE simulation when the UHCU is set as VCE=20 V.

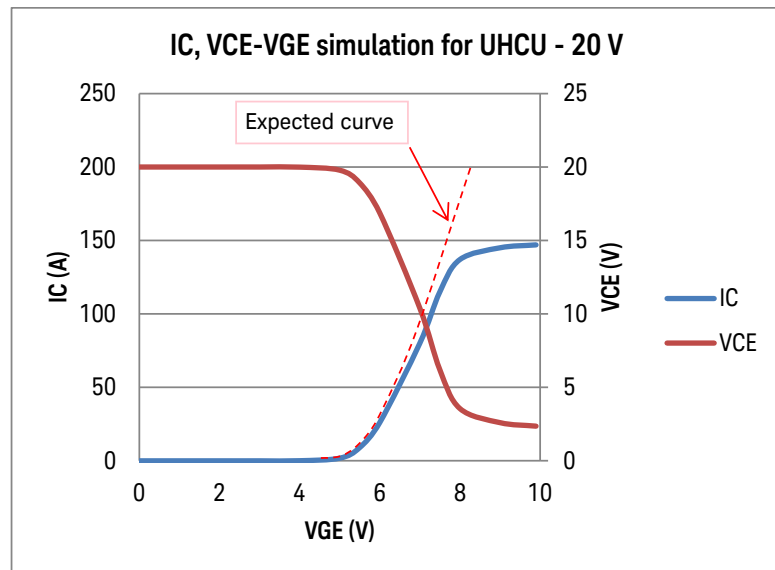

How to tune the VCE:

To measure the IC-VGE curve close to the expected curve, it is necessary to adjust the output voltage of the UHCU as next.

$$V_{set} = \text{Max IC} \times R_{out} + V_C$$

where,

- Max IC: maximum current to measure the IC-VCE characteristics
- Rout: the UHCU's output resistance
- VC: constant VCE voltage of the output characteristics measurement

In the case of the test at IC=200 A and VCE=20 V,

$$VCE = V_{set} = 200 \text{ A} \times 120 \text{ m}\Omega + 20 \text{ V} = 44 \text{ V}$$

The collector voltage VCE which is actually applied to the collector terminal, simulated using a typical IC-VGE (at VCE=20 V) curve, is shown in Figure 2-129.

The VCE voltage sharply drops as the IC increases, and the high VCE distorts the IC-VGE curve upward a little in the lower current region.

Figure 2-129

IC, VCE-VGE simulation of UHCU.

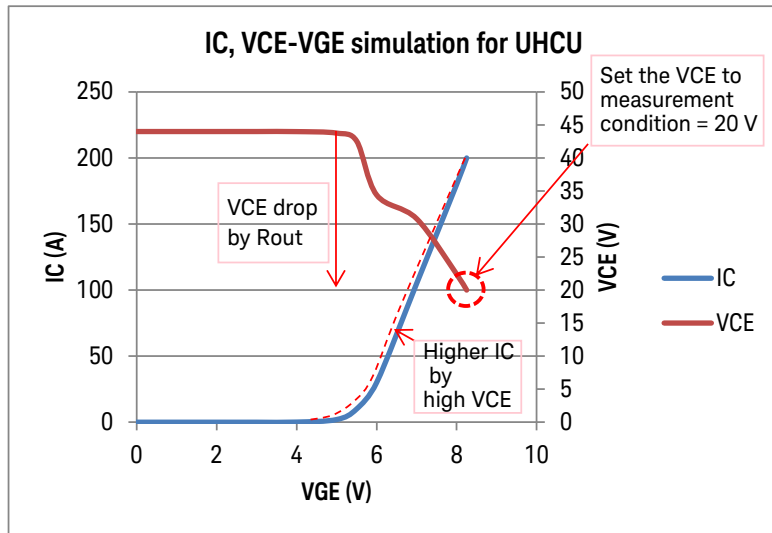

Figure 2-130 shows the IC-VGE test setup using UHCU.

Figure 2-131 is an example IC-VCE characteristics curve measured with the Figure 2-129 condition.

Figure 2-130 IC-VGE setup for the UHCU.

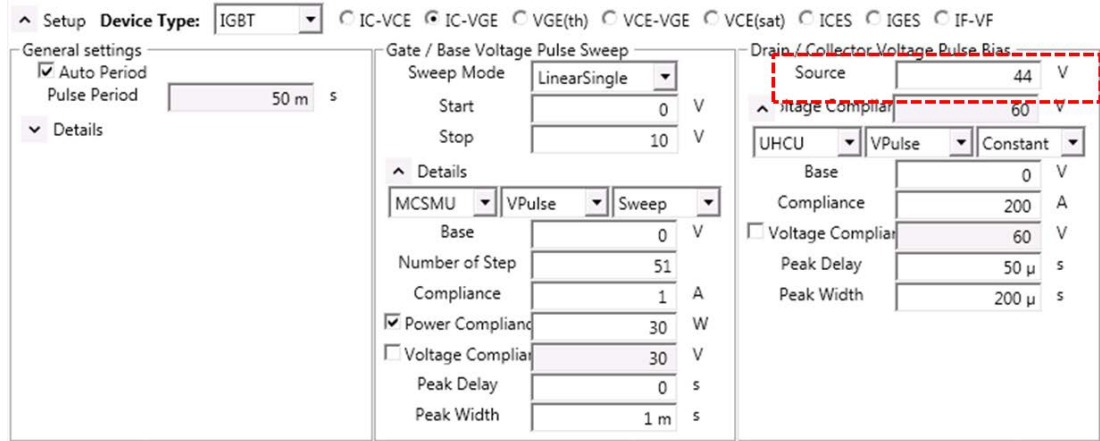
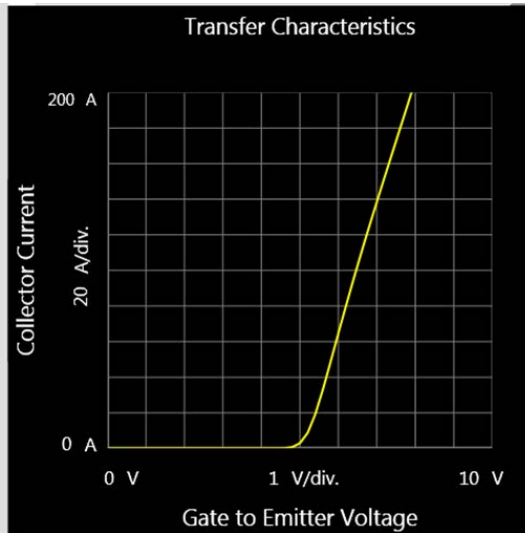

Figure 2-131 IC-VGE example of the UHCU (VCE becomes about 20 V at IC=200 A).



How to change the connections of Rg measurement

Connection of collector/drain open condition

To see the connections of Rg measurement, follow the next steps.

1. Click the the "Connections" tab.
The simplified block diagram of the current connection is shown.
2. Check "Details"
3. Click the down arrow. The connection setup panel opens under the connection block diagram as shown in Figure 2-132.
 - a. This block sets the CMU connection.
 - b. This section sets the AC guard connection.
 - c. This section defines what bias voltages are to be applied to each device terminal.
The 1, 2 and 3 numbers in this line for each column indicate the corresponding pin numbers of the device terminal shown in the same figure.
 - d. This indicates that the CMU High terminal is connected to the gate, and the drain and source are both connected to the CMU Low terminal.
 - e. This block indicates that no AC guard is connected to the DUT.
 - f. This block indicates that the gate terminal bias voltage is applied from the SMU, and nothing is connected to the collector terminal.

Figure 2-132 Connection diagram of an Rg measurement

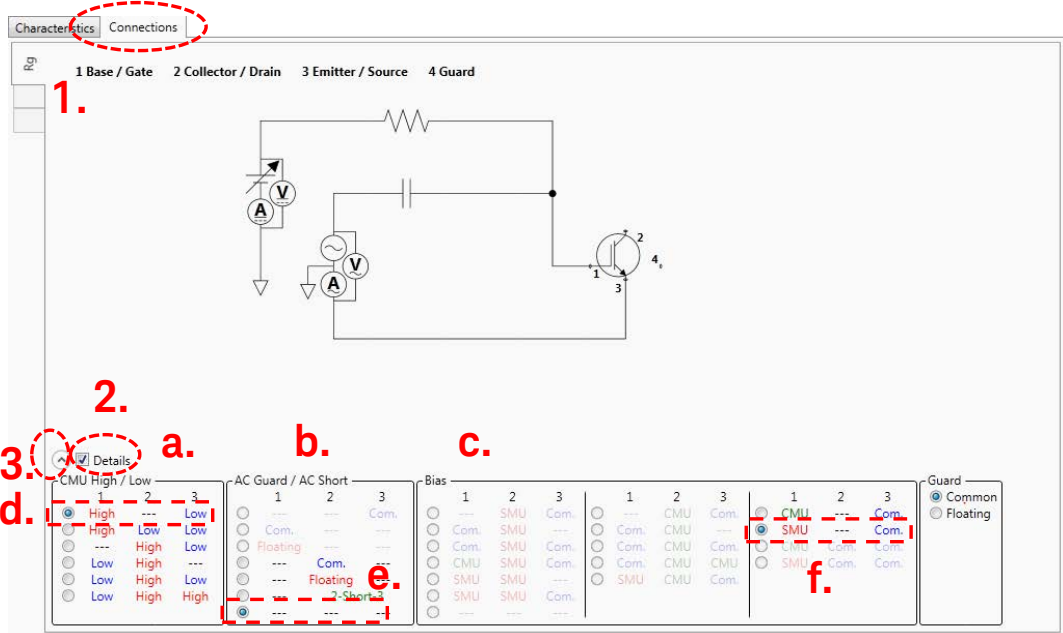

Connection of the collector/drain and the emitter/source shorted

4. Select “High Low Low” in the CMU High/Low section. This selection connects both the collector and the emitter to the low port of the CMU (Figure 2-133)

Figure 2-133 Detailed setup of an Rg measurement with the collect/drain and the emitter/source shorted.

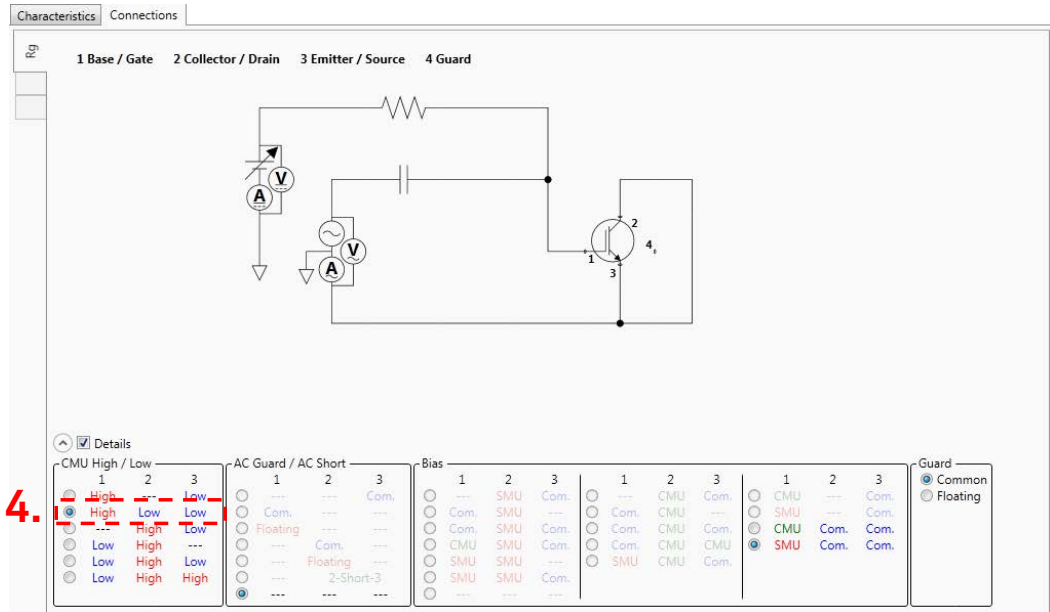

Connection of collector/drain and emitter/source shorted

5. Select “High --- Low” in the CMU High/Low section. This connects the CMU high port to the gate and the low port to the source.
6. Select “--- 2-short-3” in the AC Guard/AC Short section. This connects the collector/drain and the emitter/source via the AC short capacitor.
7. Select “SMU SMU Com.” in the bias section. This connects the MPMU to the gate, the HVSMU to the collector/drain, and the CMU low port to the emitter/source (Figure 2-133)

Figure 2-134 Detailed setup of an R_g measurement with collector/drain biased condition

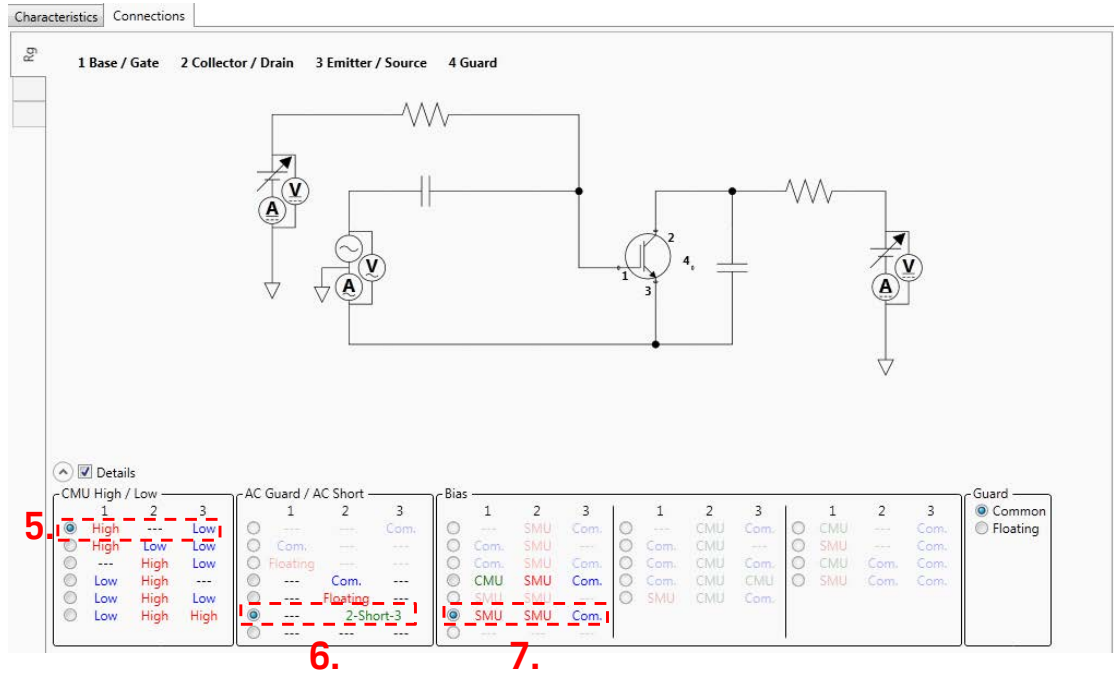

Capacitance Measurement Tips

Tips: How to measure large capacitance

If the measured capacitance exceeds the specified limit, try to change the measurement frequency to 100 kHz.

Tips: How to enhance measurement accuracy

Due to residual inductance of the device capacitance switch in the B1506A, the result using 1 MHz gets erroneous especially for a large IGBT module or super junction MOS FET which has extremely small C_{rss} and large C_{ds} .

In these cases, try to change the measurement frequency to 100 kHz.

Refer to the section " **C_{rss} measurement of super junction FET**" in the section headed "**Useful information for using capacitance measurement**".

Tips: Capacitance data dependency when lowering the measurement frequency

Even if it becomes less than the limit by lowering the frequency, the device must be fine.

When measuring a relatively large scale of devices or, the device which has very small C_{res} (or C_{rss}) compared to the C_{ies} (or C_{iss}), measurement error at 1 MHz becomes not negligible in many cases due to the influence from residual inductance, resistance and stray capacitance of the switching system.

Normally, the capacitances of the power device do not show remarkable frequency dependence with the measurement frequency of less than 1 MHz from the physical point.

Measurement theory and detail explanation of the measurement capability

Capacitance measurement techniques

The high voltage capacitance is measured by using the high voltage bias tee circuit, AC block resistor and AC short capacitor.

These components are automatically changed depending on the capacitance parameter to measure.

Following describes the connections using these components for each capacitance parameters.

Cies measurement:

Figure 2-135 shows the simplified Cies measurement circuit block. The C-E AC path is shorted by the 1 μ F capacitor, and Cgc and Cge are seen as connected in parallel between the CMH and CML measurement terminal. Therefore, $C_{ies} = C_{gc} + C_{ge}$ can be measured.

Figure 2-135

Simplified connection diagram for Cies measurement.

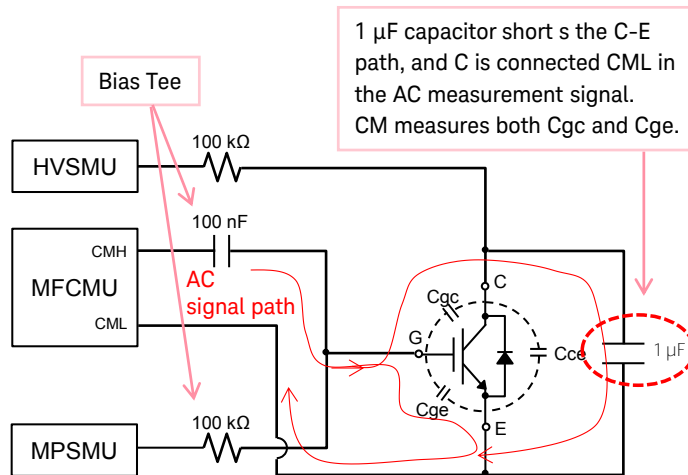

Coes measurement:

Figure 2-136 shows the simplified Coes measurement circuit block. The output capacitance, which is Cce connected in parallel with Cgc, is measured.

Figure 2-136 Simplified connection diagram for Coes measurement.

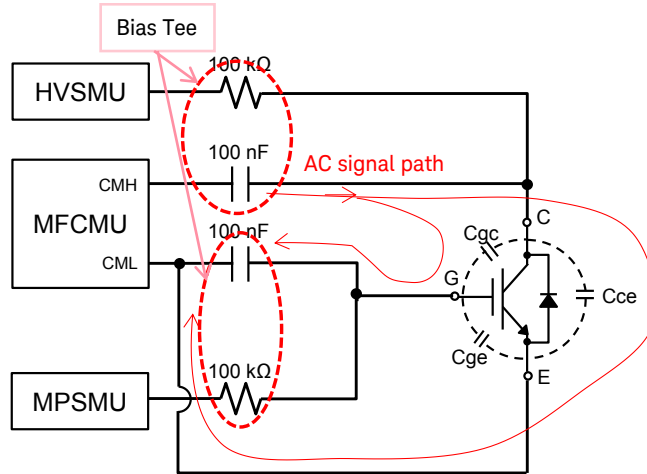

Cres measurement:

Figure 2-137 shows the simplified Cres measurement circuit block. The reverse transfer capacitance C_{ge} is measured in the CML input. Since all the AC signal flowing through C_{ce} flows into AC guard (Low port shield), which has the same potential as CML, only the current flowing from C_{ge} to CML terminal is measured.

In B1506A, MPSMU is used to apply gate voltage to the device, 0 V for normally-on device and negative voltage for normally off device.

Figure 2-137 Simplified connection diagram for Cres measurement.

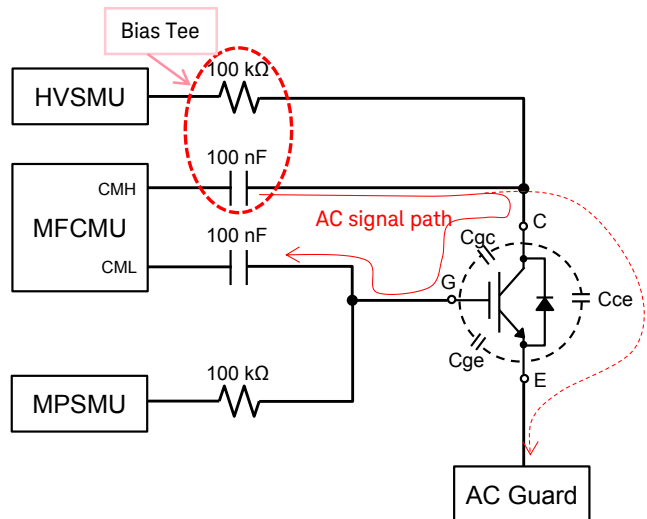

Connection diagram:

By selecting the “Connections” tab shown in Figure 2-138, the connection diagram for each measurement mode can be confirmed.

Figure 2-138 Connections diagram of each measurement mode.

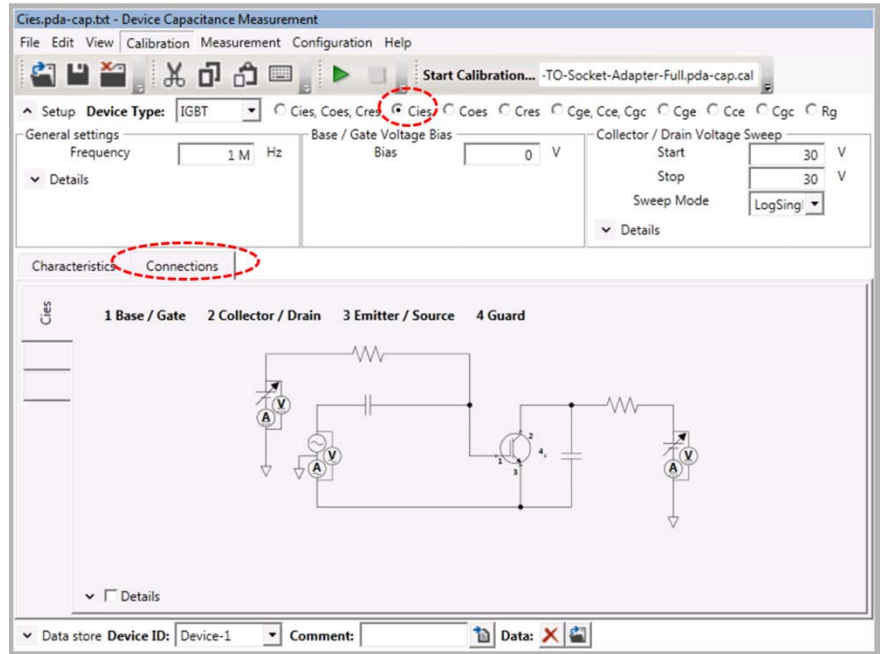

Charge up wait time:

- ✓ For Cies measurement, to charge 1 μF AC short capacitor, at least 500 ms wait time is required (5x CR time constant of 100 k Ω and 1 μF capacitor).
- ✓ For Coes and Cres, 50 ms wait time is required (5x CR time constant of 100 k Ω and 1 nF capacitor).

Note:

Those wait times are built-in and automatically selected by the Easy Test Navigator software, so it is not necessary to specify the delay time if the DUT characteristics itself does not require it.

Gate charge measurement basics

Gate charge is a charge to raise the gate voltage with a constant gate current as shown in Figure 2-139 for power MOSFET as an example. Gate charge is the sum of the following charges:

- C_{gs} charge driven by V_g
- C_{gd} charge driven by V_g
- C_{gd} charge driven by V_{DS}

Figure 2-139 Basic gate charge measurement diagram and waveform.

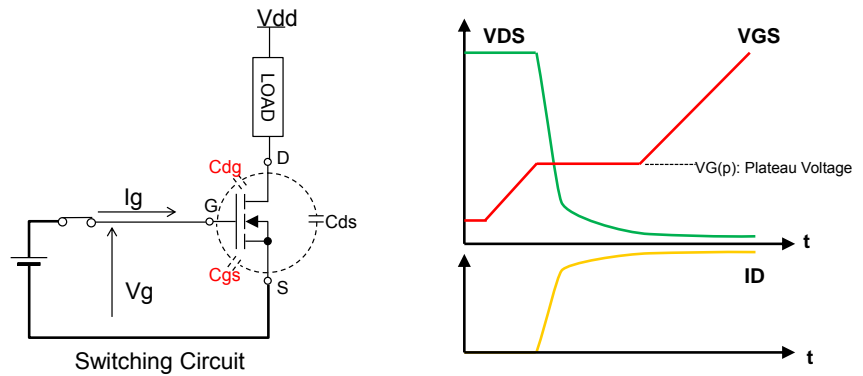

JEDEC standard 24-2 defines the gate charge (Q_g) definitions as shown in Figure 2-140, and Q_g measurement is made based on this definition.

Figure 2-140 Q_g parameter definition of JEDEC standard 24-2.

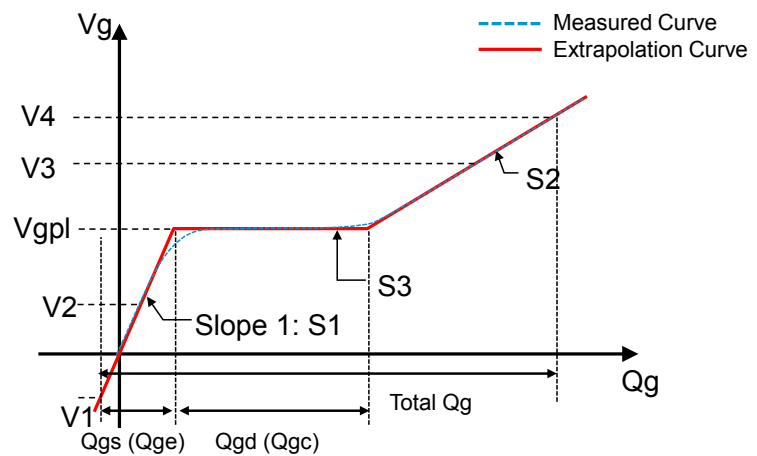

S1: Determined by the C_{gs} at the off-state

S2: Determined by the C_{iss} at the on-state

S3: Determined by the mirror capacitance (C_{gd}) during a transient from the off-state to the on-state.

V_{gpl} : Plateau gate voltage. Gate voltage to make drain current at the specified value. Higher $I_d \rightarrow$ Higher V_{gp}

SOA and current load FET in Qg test

Current load FET is used at its saturation area (constant drain current area). There is a potential risk of device breakdown by exceeding the SOA limit of the device, because the current load FET is used at high voltage and high current operating region.

This section explains how to determine the required SOA to select a current load FET, which satisfies the Qg measurement requirement.

Figure 2-141 shows the Qg measurement block diagram of the B1506A (a) and SOA determination graph of the current load FET (b).

The maximum load of the current load FET is set at Id(on) test condition and the maximum VDS voltage setting of the B1506A which is usually set higher voltage to cover the voltage drop by the built-in output resistor of the B1506A's UHCU.

The required SOA is determined by $SOA = I_{d(on)} \times (\text{Max VDS of UHCU})$ in specified UHCU's current pulse width. The current load FET's SOA has to exceed this SOA value in the specified voltage, current and pulse width.

Figure 2-141 Current load FET selection criteria in Qg test.

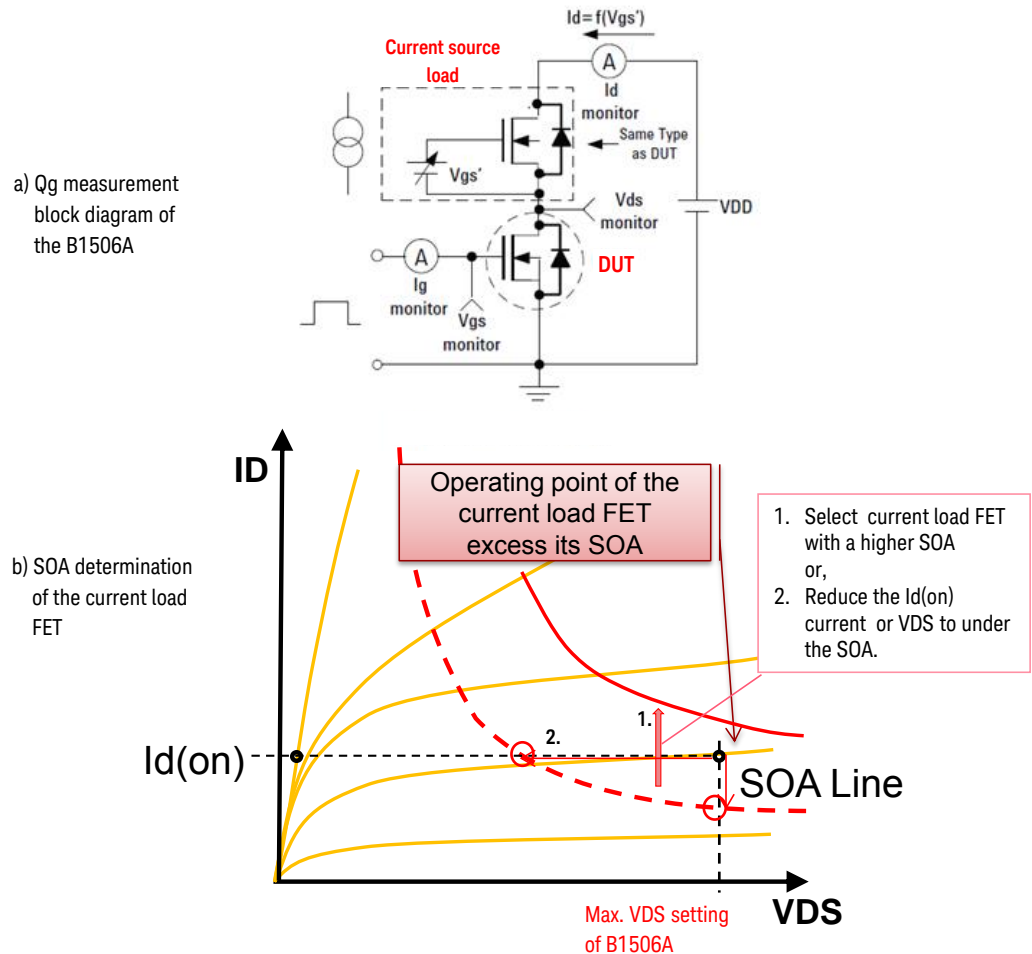

In the example (Figure 2-141(b)), the dotted SOA limit line locates under the required SOA value (= $I_d(\text{on}) \times \text{Max VDS}$ of UHCU).

Potentially, there are the following four ways to solve this SOA issue.

- ✓ Select current load FET with a higher SOA
- ✓ Reduce the $I_d(\text{on})$ current to under the SOA curve
- ✓ Reduce max. VDS of UHCU setting to under the SOA curve
- ✓ Reduce pulse width to increase the SOL line

How to determine I_g to measure gate charge

I_g is determined as a current to swing the gate voltage from $V_{GS}(\text{off})$ to $V_{GS}(\text{on})$ within a measurement period. Figure 2-142 shows a Q_g measurement pulse sequence using the UHCU.

Figure 2-142 Timing chart of the Q_g measurement.

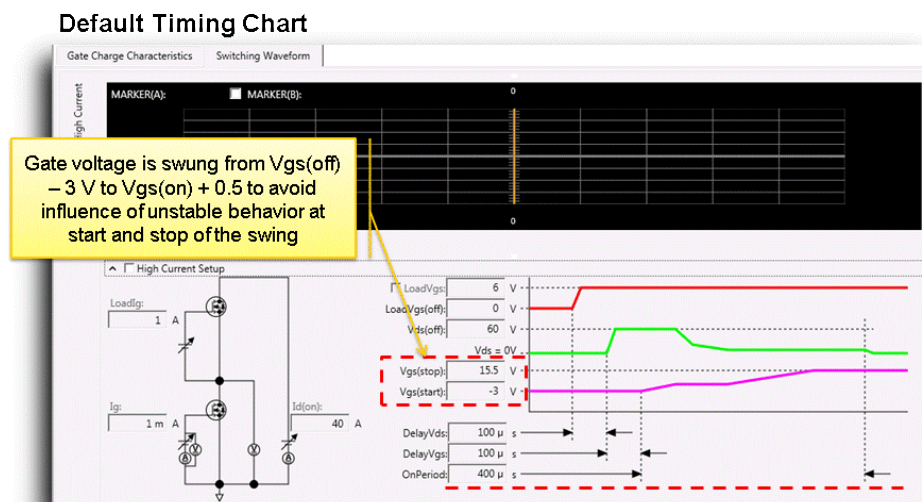

Q_g is measured during this On period
Max. 1 ms – DelayVgs (500 μ s – DelayVgs for more than 500 A)

How to use the Oscilloscope View function

The Oscilloscope View is useful to monitor the pulse waveforms of both measured or output voltages and currents. The current waveform monitoring is especially useful because the current cannot be monitored even using an oscilloscope.

This section explains a simple oscilloscope view operation in voltage and current pulse waveform monitoring using the VCE(sat) as an example.

Follow the next steps to monitor the pulse waveforms.

To open the Oscilloscope View

Figure 2-143 shows the steps to open the Oscilloscope View from VCE(sat) VCE-VGE graph measurement. Open the Oscilloscope view by following the numbers by referring to the corresponding number in the figure.

1. Click Setup and the VDE-VGE I/V measurement window opens.
2. Click "< Oscilloscope View".
3. Oscilloscope View panel opens.

Figure 2-143 Opening the Oscilloscope View.

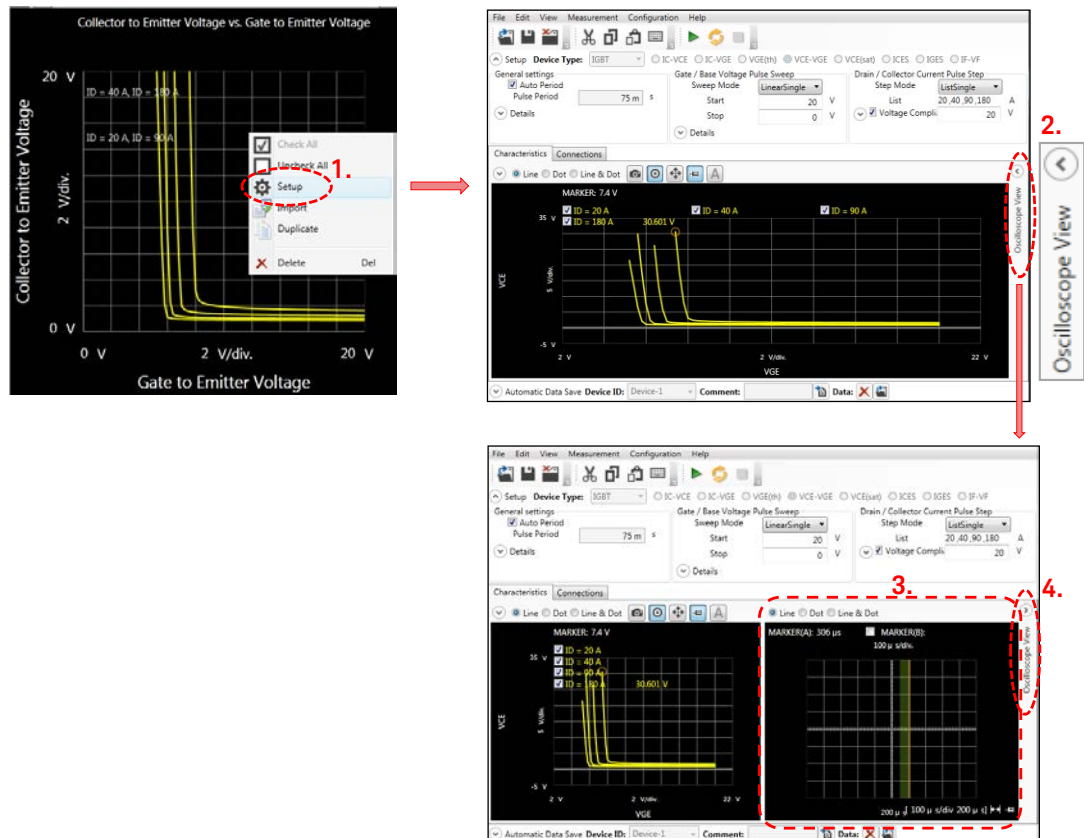

4. To close the Oscilloscope View
Clicking "> Oscilloscope View" again will close the Oscilloscope View panel.

How to set up Oscilloscope View

Figure 2-144 shows the key location to set up the Oscilloscope View. Next steps explain the functions of each setup point. Follow the steps by referring to the number in the figure.

5. The VCE-VGE graph is shown in "Line & Dot" format to easily indicate the measurement position.
6. Place the marker by clicking the measurement point. The marker position is the point to measure the waveform in Oscilloscope View panel.
7. Shows the time at the center of the scale.
8. Specifies or shows the time scale per division.
9. The vertical pin mark shows "Auto scale" mode.
10. Clicking the pin toggles between Auto/Manual scaling mode. Horizontal pin mark shows "Manual scale" mode. In auto-scale mode, the scale changes automatically in each measurement timing.
11. Green vertical bar indicates the measurement aperture timing.
12. Orange vertical line shows the marker reading line. The line position can be moved by clicking on the horizontal center line position, or dragging the line.
13. The marker time and the data appears in this area.

Figure 2-144 Oscilloscope View setup.

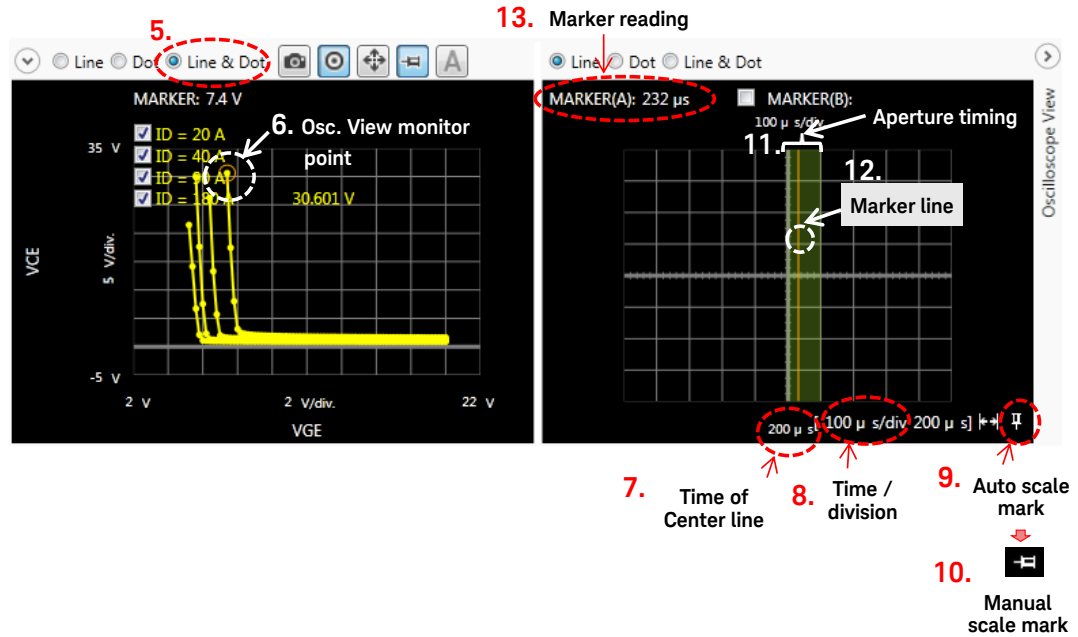

How to measure the pulse waveform

Figure 2-145 shows the Oscilloscope view measurement example.

Following steps explain the Oscilloscope measurement.

1. Start measurement measures one sweep for all the measurement points and the waveform at the specified measurement IV point.
2. Repeat measurement repeats the I/V sweep measurements and the waveform.
If the I/V marker position of the I/V graph is changed while in the repeat measurements, the waveform measurement is made at the new I/V marker position in the next timing.
3. The monitor parameters are shown, and the checked parameters are shown in the Oscilloscope View.
4. The vertical scales of the selected parameters appear. Auto/Manual scaling and the scale is displayed. In the manual scaling, the vertical scale (scale and the center line) can be fixed. Manual scaling is preferred when comparing data in different measurement points.
5. The Oscilloscope View marker (time and magnitude of each parameter at the marker line position) data are shown.
6. In the repeat measurements, moving the I/V marker position measures new waveforms in the new I/V point in the next measurement timing.

Figure 2-145 Measurement in the Oscilloscope View.

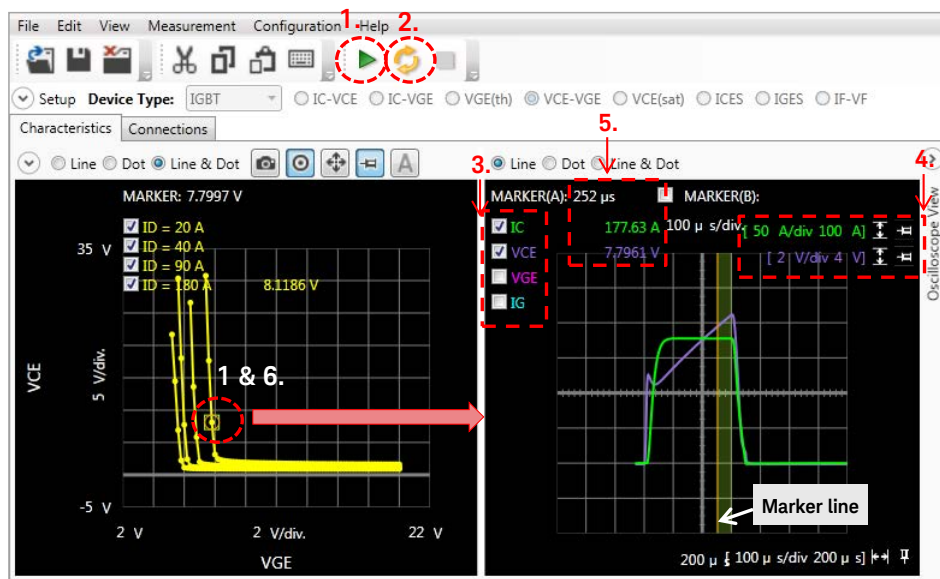

3. I/V Measurement

Overview	180
Measurement parameters of device types.....	181
Demonstration examples	183
How to open the I/V measurement mode.....	184
IV measurement examples	185
1. IC-VCE IGBT characteristics	185
2. ID-VDS power MOSFET characteristics	192
3. ID-VGS power MOSFET characteristics	196
4. Vgs(th) power-MOSFET characteristics.....	198
5. RDS-ID power MOSFET characteristics	200
6. VDS-VGS, RDS-VGS power MOSFET characteristics.....	202
7. IDSS power MOSFET characteristics.....	206
8. IGSS power MOSFET Characteristics	210
9. IS-VSS power MOSFET Characteristics.....	212
10. IGBT module measurement	215
Connection with the B1506A	215
An IGBT module measurement example	217
Useful information for using I/V measurement mode.....	219
The differences between the quick mode and the fine mode	219
How to avoid device oscillation	222
Accurate measurement using a narrow pulse	223
Super junction MOSFET example	223

Overview

The I/V measurement mode is used to measure static electrical characteristics of power devices like I_d - V_{ds} , I_d - V_{ge} , V_{th} , I_{dss} or I_{gss} measurement.

The function and the operation of the I/V measurement mode are basically the same as the characteristics graph of the datasheet characterization mode where the pre-defined measurement setup opens when you click on the target characteristics graph.

Figure 3-1 shows an example I/V measurement setup template. Refer to the corresponding number in the figure for following explanations for the template.

1. There are 6 choices in the device types.
 - MOSFET
 - IGBT
 - BJT
 - Diode
 - Generic2T
 - Generic
2. There are a few selections of measurement template in each device type.
The figure shows the selection of the MOSFET measurement template.
Refer to Table 3-1 to 3-5 for supported measurement templates.
3. In the I/V measurement mode, all the measurement setup parameters are opened to you, and you have to set all the necessary measurement parameters by yourself.

Note: In the case of the datasheet characterization mode, some parameters relating to the maximum rating of the device are automatically limited when the I/V measurement setup window opens.

Figure 3-1 Example of the I/V measurement template.

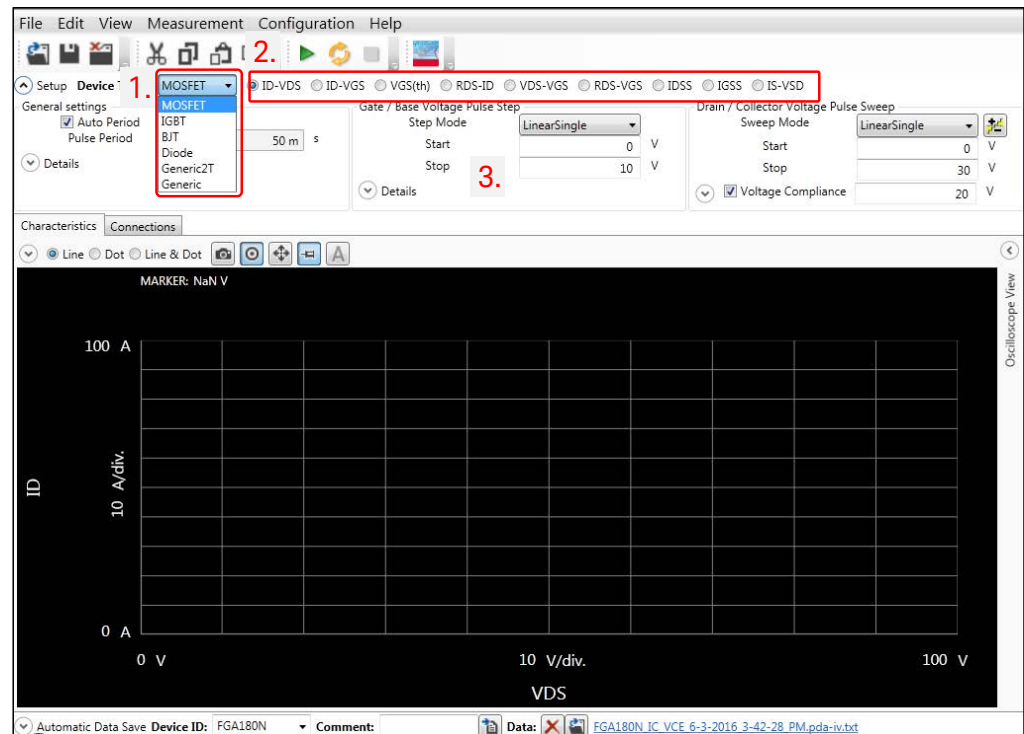

Measurement parameters of device types

I/V Measurement parameters

IV Measurement mode supports the following device types and device characteristics chart.

Table 3-1 I/V Measurable parameters for MOSFET

Graph	Description
ID-VDS	ID-VDS characteristics with various VGS
ID-VGS	ID-VGS characteristics with constant VDS
VGS(th)	Gate Threshold Voltage
RDS-ID	RDS(on)-ID characteristics with various VGS
VDS-VGS	VDS-VGS characteristics with various ID
RDS-VGS	RDS(on)-VGS characteristics with various ID
IDSS	ID-VDS characteristics of Drain Leakage Current
IGSS	IG-VGS characteristics of Gate Leakage Current
IS-VSD	IS-VSD characteristics of Body Diode Forward Voltage

Table 3-2 I/V Measurable parameters for IGBT

Graph	Description
IC-VCE	IC-VCE curve with various VGE
IC-VGE	IC-VGE curve with constant VCE
VGE(th)	Gate Threshold Voltage characteristics
VCE-VGE	VCE(sat) Collector Saturation Voltage versus VGE curve
VCE(sat)	VCE(sat) Collector Saturation Voltage versus IC curve
ICES	IC-VCE Collector Leakage Current characteristics
IGES	IG-VGE Gate Leakage Current characteristics
IF-VF	Freewheeling Diode Forward characteristics

Table 3-3 I/V Measurable parameters for BJT

Graph	Description
IC-VCE	IC-VCE curve with various IB
hFE	hFE-IC curve with constant VCE
VBE(on)	VBE-IC curve with constant VCE
ICEO	IC-VCE Collector Leakage Current characteristics (base open)
ICES	IC-VCE Collector Leakage Current characteristics (base common)
IEBO	IB-VBE Emitter Leakage Current characteristics (collector common)

Table 3-4 I/V Measurable parameters for Diode

Graph	Description
IF-VF	Forward Characteristics
IR-VR	Reverse Characteristics

Table 3-5 I/V Measurable parameters for Generic2T device

Graph	Description
Conduction	Collector/Drain-Emitter/Source conduction resistance versus current characteristics
Isolation	Collector/Drain-Emitter/Source leakage current versus voltage characteristics

Table 3-6 I/V Measurable parameters for Generic device

Graph	Description
I-V	Collector/Drain-Emitter/Source I-V characteristics

Demonstration examples

The following measurement examples are shown as demonstration of the I/V Measurement mode in the following sections.

1. IC-VCE IGBT
2. ID-VDS power MOSFET
3. ID-VGS power MOSFET
4. Vgs(th) power-MOSFET
5. RDS-ID power MOSFET
6. VDS-VGS, RDS-VGS power MOSFET
7. IDSS power MOSFET
8. IGSS power MOSFET Characteristics
9. IS-VSS power MOSFET Characteristics
10. IGBT module

How to open the I/V measurement mode

The I/V measurement mode is started from the Easy Test Navigator as shown in Figure 3-2.

- ✓ Click on “I/V Measurement” to start the template.
- ✓ The I/V Measurement template shown in Figure 3-1 opens.

Figure 3-2

The I/V measurement mode start up from the Easy Test Navigator.

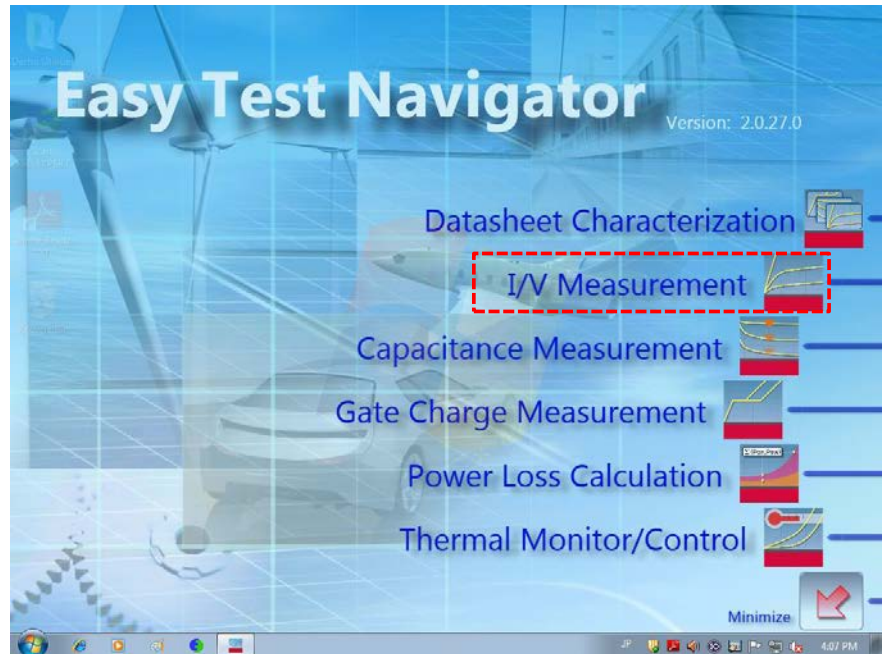

IV measurement examples

1. IC-VCE IGBT characteristics

In this example, a discrete IGBT FGA180N33ATD, which is used in Datasheet Characterization, is used as the example test device. This device has the following basic characteristics.

- ✓ VCES: 330 V
- ✓ VGES: +/-30 V
- ✓ IC: 180 A(DC), 450 A(Pulse)



FGA180N33ATD
IGBT

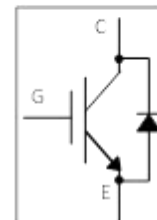
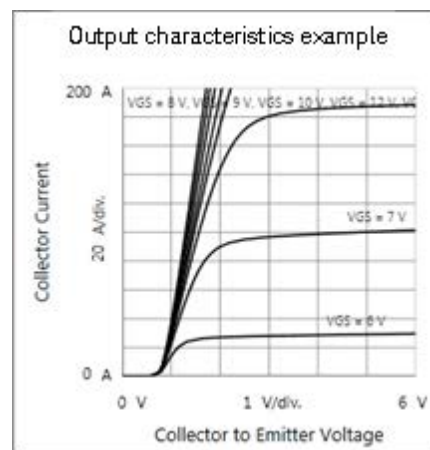

Figure 3-3

Output characteristics of FGA180N33ATD.



- ✓ Set the test device in the fixture as shown in Figure 3-4.

Figure 3-4

B1506A Opt. F10 3 pin Inline Package Socket Module, and IGBT setting on the socket.





Follow the next steps to set up the IC-VCE of IGBT by referring to the corresponding number in Figure 3-5.

1. Select "IGBT" as the device type.
2. Check the "IC-VCE"
3. Set the scaling mode as a fixed scale by clicking the "push pin" icon.
4. Set the maximum value of the vertical axis as 200 A
5. Set the maximum value of the horizontal axis as 6 V
6. Select "ListSingle" as the step mode of the gate/base voltage pulse setup
7. The step mode changes to "ListSingle", and the list of the step voltage is shown.

When you move the mouse cursor on the step voltage list area, the step voltage list is also shows up in the pop-up display as shown in list 7a.

Click on the mouse on the step voltage list area.

Figure 3-5 IC-VCE I/V measurement setup.

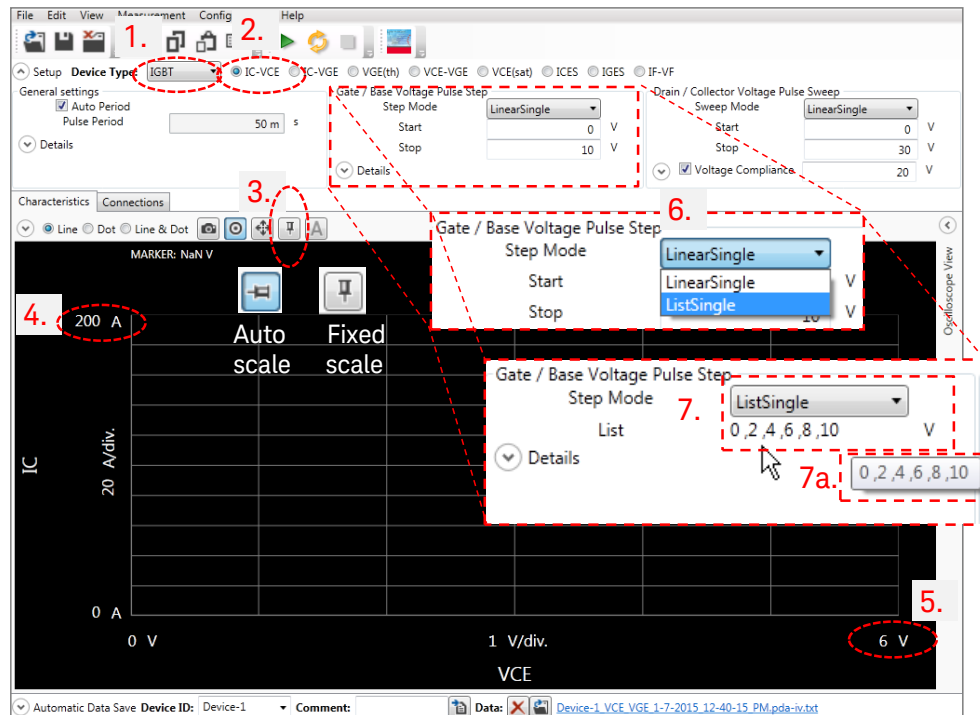

Refer to Figure 3-6 from step 8.

8. The edit list pull-down menu is displayed. Create a gate step voltage list based on the IC-VCE chart of the datasheet (VGE = 6 V, 7 V, 8 V, 9 V, 10 V, 12 V, 15 V and 20 V)
9. You can insert a new value to the list, delete value from the list and change the order of the value by clicking the up and down operation button over the list. Select and activate the editing line by clicking the white space area of the field, and then click on the desired operation button.
10. To edit the step voltage value, click on the data to activate the data modification.

Figure 3-6 Step list of the gate step voltage.

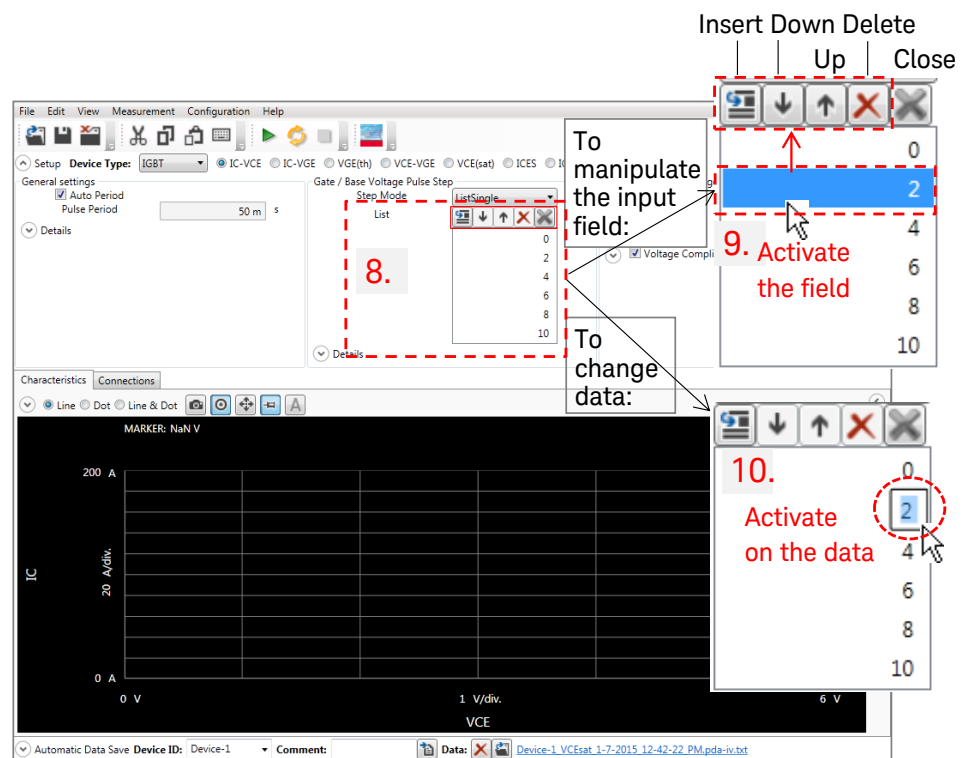

Refer to Figure 3-7 from step 11.

11. Set the stop voltage as “30 V”. This value is the stop voltage of the internal voltage source of the UHCU, not the stop voltage of the sweep at the device terminal.
12. Click the “Details” mark to show the detailed setup for collector term. The details of the collector term setup are shown. The test module can be set in the details setting.
13. Set “200A” as a compliance current. It limits the current flowing into the device at the upper limit of the vertical scale.

14. Confirm that the “Voltage Compliance” is checked, and set “6 V” as the voltage compliance.
This value is used to stop the sweep at the edge of the horizontal axis.
15. You can check the detail of the gate setup.
Click on the details mark of the gate/base setup.
16. The details of the gate setup are shown.

Figure 3-7 Collector parameter setup.

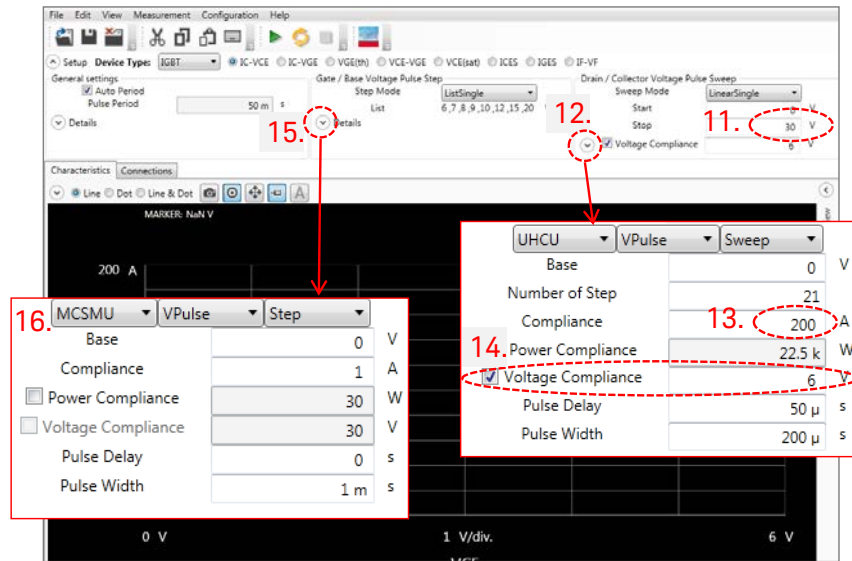

Tips:

How to determine the stop voltage

The voltage actually applied to the device is determined by the setting voltage, output current and the voltage at the device terminal due to a load line effect of the UHCU.

From the IC-VCE characteristics of the datasheet (equivalent to Figure 3-3), the maximum voltage and current point is the right upper corner of the chart, 200 A and 6 V. To draw the IV chart in the whole area, the maximum setting voltage of the UHVU becomes,

$$6 + 200 \text{ A} \times 120 \text{ m}\Omega = 30 \text{ V}$$

Note:

Refer to "How to set voltage force mode setup" in "UHCU Details and Measurement Tips" of Chapter 2 for the basic steps to set up the stop voltage.

Follow the next steps to start measurement by referring to Figure 3-8.

17. Click the “Setup” mark to close the setup of measurement and expand the chart area
18. Click the measure button to start measurement.
The measurement result is shown as Figure 3-9.

Figure 3-8 Start IC-VCE I/V measurement.

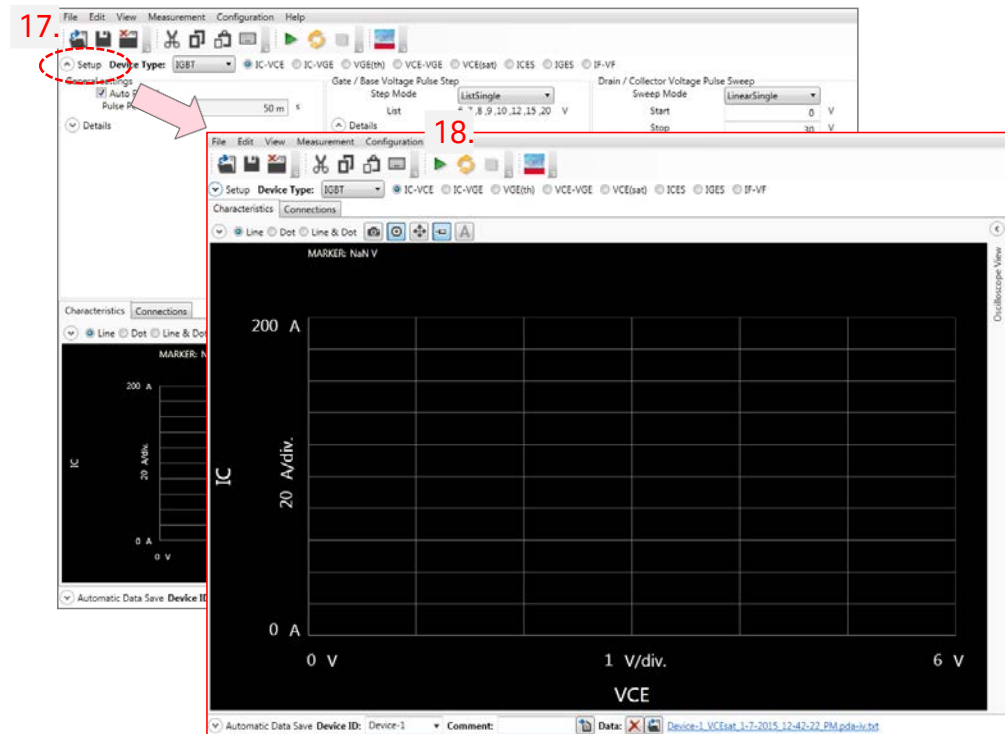

Tips:

To display the gate voltage label:

After finishing the measurement, it is possible to display the gate voltage label on the measured traces.

19. Click the view label button (“A” button in Figure 3-9).
Gate voltage label (i.e. VGE=6 V, . . .).

At the upper right corner, sometimes, an exclamation mark appears after finishing the measurement (Figure 2-70). It indicates a certain abnormal status is reported during the measurement. In the case of the IC-VCE measurement, since measurement at voltage or current exceeds the specified voltage and current compliances are skipped, the exclamation mark appears. Details of the reported status can be checked by clicking the mark.

Figure 3-9

IC-VCE measurement result.

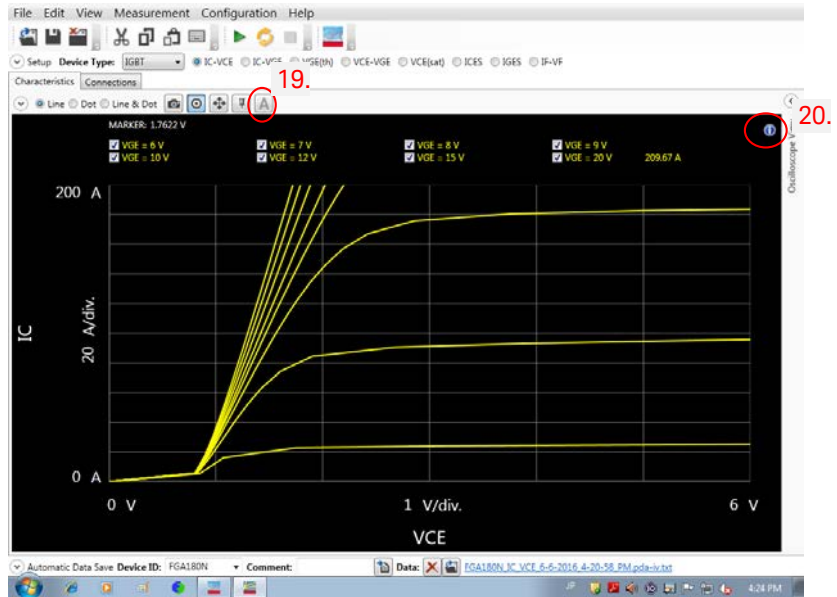
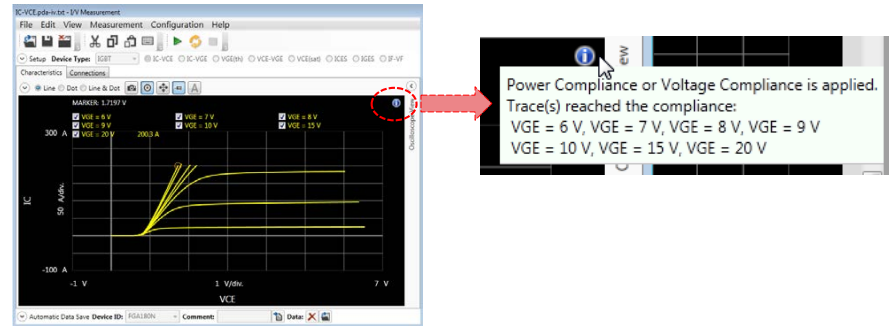

Figure 3-10

Notification of measurement status



Tips:

Automatic data store:

- ✓ Measured data is automatically saved into the specific directory, "C:\Users\B1505User\Documents\Keysight\SeriesB150x\PowerDeviceAnalyzer\IV\DataStore". (Refer to Figure 3-11.)
The save folder path can be a unique one including the external storage.
- ✓ The file name is automatically assigned by the device ID, date and time. The file name can be modified manually. (Figure 3-11, #1)

How to access to previous data:

- ✓ You can access the previous data by showing the recent data. This list shows the measured data in the day. (Figure 3-11, #2)
- ✓ If you want to access older data, click "more..." and the explorer window appears (Figure 3-11, #3).

How to re-load previous data:

- ✓ Measured data can be re-loaded by clicking the file name in the recent data or by opening the data file. The measurement setup and result are recalled and measured data is displayed.

Figure 3-11 Automatic data store.

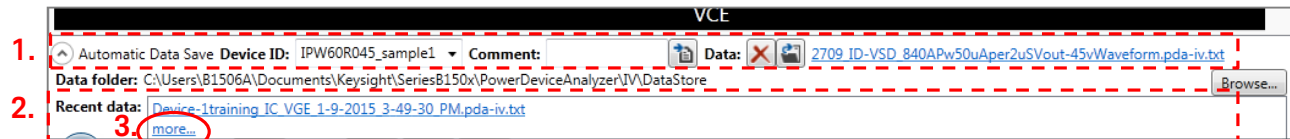
**Tips:****How to save the measurement setup:**

You can save the setup without a measurement data by electing the “Save Setup As...” from the “File Menu” as shown in Figure 3-12.

Figure 3-12 Saving the setup only

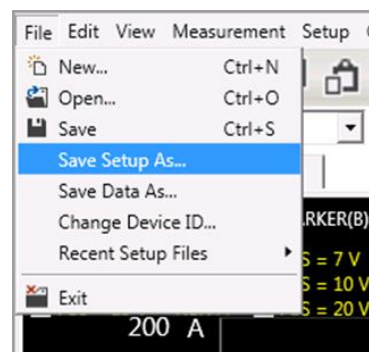
**Tips:****How to add a series resistor to prevent oscillation**

To avoid device oscillation of MOS and IGBT devices, inserting a series resistor to the gate terminal is useful. The B1506A has built-in selectable series resistance in the gate connection path.

Refer to "**How to avoid device oscillation**" in the section headed "**Useful information for using I/V measurement mode**" of this chapter for further information about the topics.

2. ID-VDS power MOSFET characteristics

In this example, discrete power MOSFET IRFP4004 is used as the example test device. This device has the following basic characteristics.

- ✓ VDSS: 40 V
- ✓ IDM: 350 A(DC), 1390 A(Pulse)
- ✓ RDS(on): Typ. 1.35 mΩ



IRFP4004
HC MOS

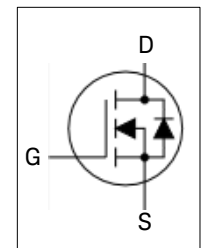
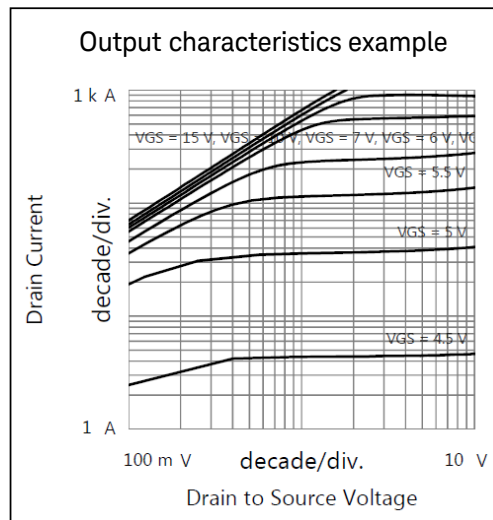

- ✓ Set the test device to the fixture in the same way as shown in Figure 3-4.

ID-VDS setup:

Follow the next steps to set up ID-VDS of MOSFET by referring to the corresponding number in Figure 3-13.

1. Select "MOSFET" as device type.
2. Check the "ID-VDS".
3. Set the scaling mode as a fixed scale by clicking the "push pin" icon.
4. Set the maximum value of the vertical axis as 500 A.

Note:

Maximum current rating of the Inline socket adapter is 500A.

Since the maximum current of the inline socket adapter is limited at 500 A, the maximum drain current during this example is limited at 500 A.

5. Set the maximum value of the horizontal axis as 10 V
6. Clicking the arrow to open/close the Oscilloscope View.
7. The figure shows the graph at "Oscilloscope View opened". Select "ListSingle" as step mode of the gate/base voltage pulse setup.
8. Create a gate step voltage list based on the IC-VCE chart of the datasheet.
They are 4.5, 5, 5.5, 6, 7, 8, 10, 15 V.
9. Set stop voltage as "60 V". This value is the stop voltage of the internal voltage source of the UHCU, not the stop voltage of the sweep at the device terminal.

Note:

The ideal stop voltage is calculated as

$$\text{Stop V (ideal)} = 120 \text{ m}\Omega \times 500 \text{ A} + 10 \text{ V} = 70 \text{ V},$$

but the maximum output voltage of UHCU is limited to 60 V.

Therefore, we set maximum 60 V here.

10. Set "500A" as a compliance current. It limits the current flowing into the device at the upper limit of the vertical scale.
11. Confirm the "Voltage Compliance" is checked and set "10 V" as the voltage compliance. This value is used to stop the sweep at the edge of the horizontal axis.
12. Drain pulse setup:
Set the drain "Pulse Width" to 100 μs .
Note:
SOA limit of IRFP4004 is about 350A @ 10 V D-S, or 500 A @ 6 V, at 100 μs pulse. Therefore 100 μs pulse width is allowable maximum value.
Set the drain "Pulse delay" to 6 μs .

Note:

We would like to set the drain channel to on status when UHCU outputs the pulse.

This is because, the MCSMU of gate pulse is slower than UHCU 's drain pulse, and add a few delay time to the drain to match with the gate pulse.

13. Gate pulse setup:
Set "Pulse Delay = 0"
Set "Pulse width = 200 μs ".

Note:

Gate pulse must longer than Drain pulse plus drain pulse delay plus Drain current off time (typically less than 50 μs).

14. Set aperture time to 30 μs .
The aperture time is set as a rule of sum,
Aperture < Drain pulse width - (drain and gate settling time).

Note: Overall pulse setting must be confirmed, especially when the pulse width is narrower, using Oscilloscope View for at least following three points:

- Low current and high voltage region.
- High current and high voltage region.
- Highest current region.

(Typically low voltage due to the voltage drop by the output resistor of the UHCU.)

15. Click "Single" or "Repeat" measurement button.
Figure 3-14 shows the measurement result both X and Y scales displayed in log scale.

Figure 3-13 ID-VDS setup.

The screenshot shows the ID-VDS setup software interface. Key elements include:

- 15:** 'Single' and 'Repeat' measurement buttons in the toolbar.
- 1:** 'Device Type' dropdown menu set to 'MOSFET'.
- 2:** 'ID-VDS' radio button selected in the 'Setup' panel.
- 7:** 'ListSingle' dropdown menu in the 'Gate / Base Voltage Pulse Step' section.
- 8:** A list of voltage steps (4.5, 5, 5.5, 6, 7, 8, 10, 15 V) in the 'List' table.
- 9:** 'Stop' voltage field set to 60 V in the 'Drain / Collector Voltage Pulse Sweep' panel.
- 10:** 'Compliance' field set to 500 A.
- 11:** 'Voltage Compliance' checkbox checked.
- 12:** 'Pulse Width' field set to 100 μs.
- 13:** 'Pulse Width' field set to 200 μs in the 'Details' section.
- 14:** 'Aperture' field set to 30 μs.
- 3:** 'Line' and 'A' icons in the 'Connections' panel.
- 4:** 'MARKER: 8.821 V' and '500 A' in the 'Oscilloscope View'.
- 5:** 'Device ID: IRFP4004' and 'Data: IRFP4004_ID_VDS_1-8-2015_1-48-04_PM.pda-iv.txt' at the bottom.
- 6:** 'Oscilloscope View' button on the right side.

Figure 3-14 ID-VDS test result.

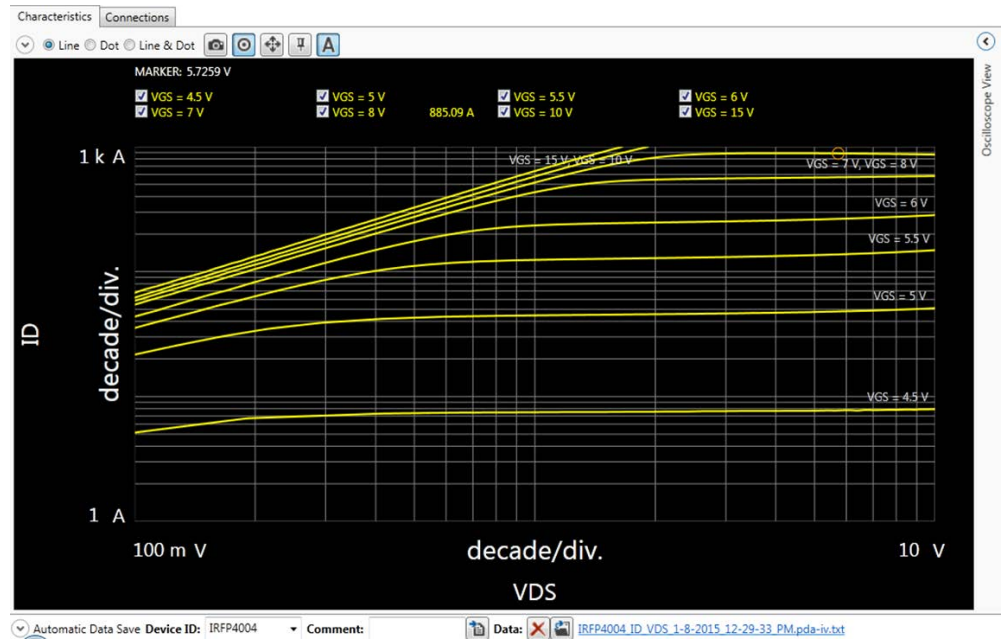

3. ID-VGS power MOSFET characteristics

In this example, discrete power MOSFET IRFP4004, which is the same device used in the previous example, is used.

This example measures VDS-VGS in the low current region.

In the low current region, Vth is specified at ID=250 μ A and the Vth is specified as between 2 V to 4 V.

In this example, we would like to check the Vth at VDS = 5 V condition.

Since the measurement current is small, this example uses MPSMU as the drain power supply and DC bias voltage.

ID-VGS setup:

Follow the next steps to set up the ID-VGS of MOSFET by referring to the corresponding number in Figure 3-15.

1. Select "MOSFET" as the device type.
2. Check the "ID-VGS"
3. Open the drain detail setup, and then set as follows:
 - MPSMU as the measurement module.
 - Set V mode.
 - Set Constant.
4. Set the drain source voltage to constant 5 V.
5. Set Compliance: 1 mA to cover 250 μ A.
6. Open the gate detail setup, and then set as follows:
 - MPSMU as the measurement module.
 - Set V mode.
 - Set Sweep mode.
7. Set the gate voltage sweep to,
 - Linear single.
 - Start = 1 V.
 - Stop = 4.5 V to cover 2 - 4 V Vth range.
8. Set the gate sweep points.
9. Set general detail setup as follows:
 - Trace Mode as Fine.
 - NPLC = 1.
10. Click the start measurement button.
11. ID-VGS graph is drawn as shown in Figure 3-16.
12. Click the marker icon to show marker on the measurement curve.
13. Move the marker by dragging by the marker to about 250 μ A.
14. The marker reading shows (as an example),
 - ID = 244.62 μ A.
 - VD = 3.17 V.

Figure 3-15 ID-VGS setup.

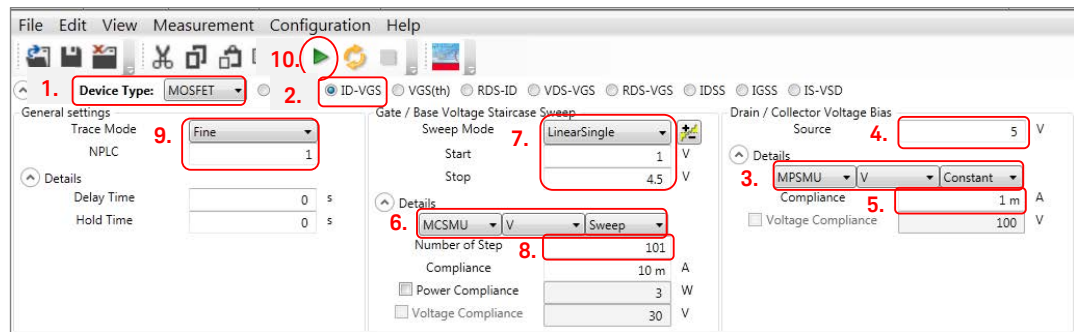
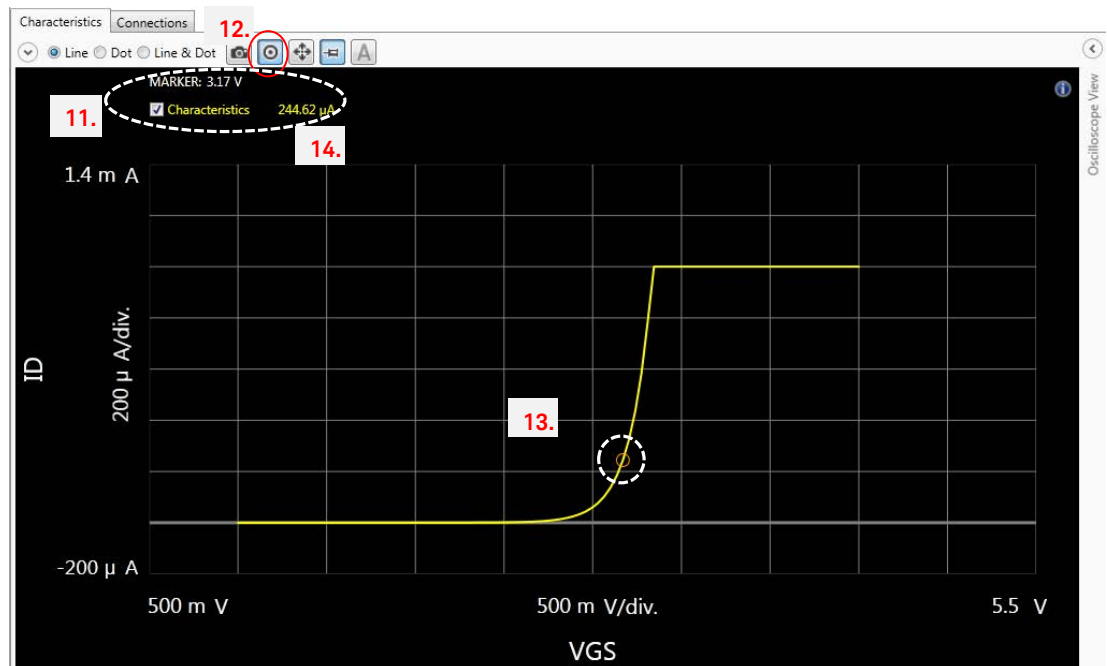

Figure 3-16 ID-VGS test result.



Note: To measure ID-VGS characteristics at lower current range, it is recommended that you use “Fine” mode. “Fine” mode uses limited auto ranging to use an appropriate measurement range and PLC mode of measurement time to reduce measurement noise comes from the commercial power source. “Fine” mode is available only when the DC bias mode (V or I) is used. When using pulsed bias mode (VPulse or IPulse), “Quick” mode is used. “Quick” is a measurement mode used in Easy Test Navigator version 1.xx.xx. For more details of the differences between “Quick” mode and “Fine” mode, refer to “**The differences between the quick mode and the fine mode**” in the section headed “Useful information for using I/V measurement mode”.

4. $V_{gs(th)}$ power-MOSFET characteristics

In this example, the discrete power MOSFET IRFP4004, which is the same device used in the previous example, is used.

This example measures the VDS-VGS characteristics to extract threshold voltage, $V_{gs(th)}$. In the datasheet of the power devices, the $V_{gs(th)}$ is defined as gate voltage where specified drain current is flowing with a condition $V_{GS} = V_{DS}$.

In the $V_{gs(th)}$ measurement setup, the drain and gate terminals of the device are connected physically inside the B1506A test fixture (Figure 3-17).

Only the MPSMU can be connected to both the drain and the gate terminals.

Figure 3-17 A connection diagram of the $V_{gs(th)}$ and the ID-VGS

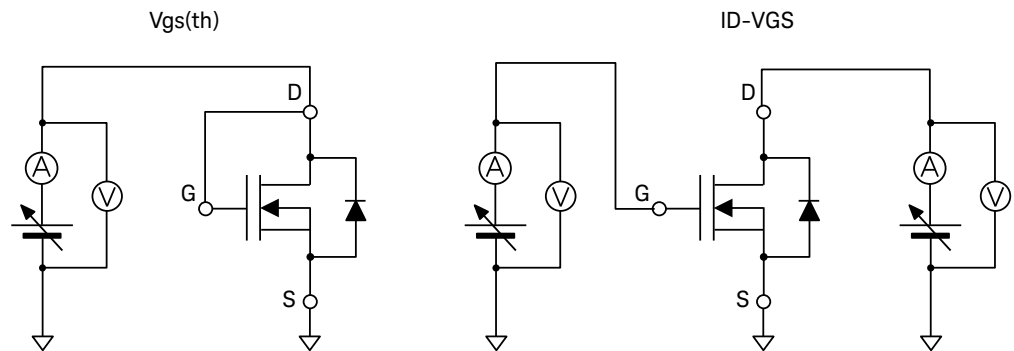

In this example, we would like to check the $V_{gs(th)}$ at $I_D = 250 \mu A$.

$V_{gs(th)}$ setup:

Follow the next steps to set up the ID-VGS of MOSFET by referring to the corresponding number in Figure 3-18.

1. Select "MOSFET" as the device type.
2. Check the " $V_{gs(th)}$ ".
3. Open the gate detail setup, and then set as follows:
 - MPSMU as the measurement module.
 - Select I mode.
 - Select Sweep.
4. Set the Gate / Base Current Staircase Sweep as follows:
 - LinearSingle.
 - Start = $10 \mu A$.
 - Stop = $250 \mu A$.
5. Set number of step
6. Open the General detail setup, and then set as follows:
 - Trace Mode as Fine.
 - NPLC = 1.
7. Click the start measurement button
8. ID-VGS graph is drawn as shown in Figure 3-19

9. Click the marker icon to show marker on the measurement curve.
10. Move the marker by dragging by the marker to about 250 μA .
11. The marker reading shows (as an example),
 - ID = 250 μA
 - VD = 3.18 V

Figure 3-18 Vgs(th) setup.

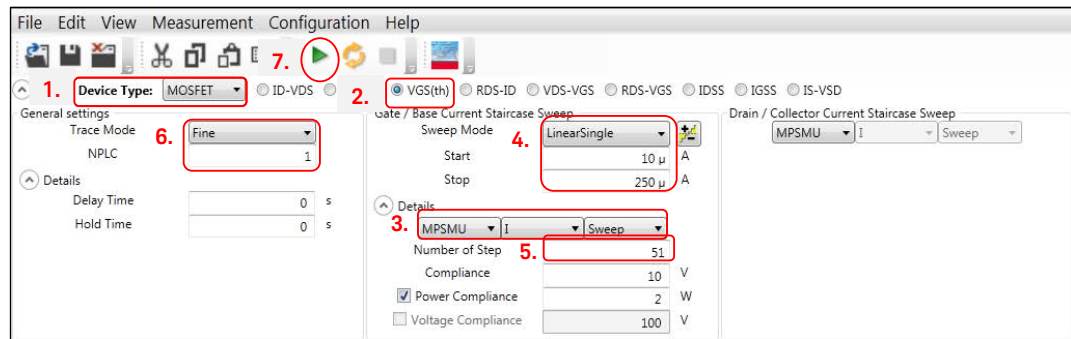
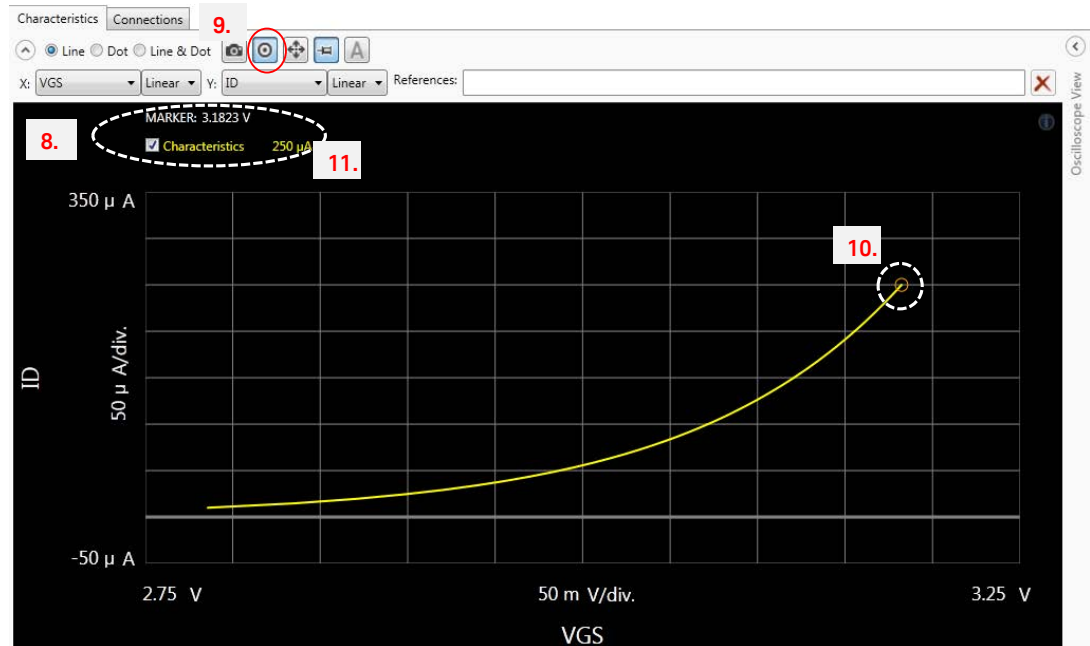

Figure 3-19 Vgs(th) test result.



5. RDS-ID power MOSFET characteristics

In this example, the discrete power MOSFET IRFP4004, which is the same device used in the previous example, is used.

In this example, we would like to measure RDS-ID characteristics with several VGS steps as follows;

- ID: 10 A to 300 A.
- VGS: 6.5 V, 10 V, 12 V.
- RDS: up to 3 m Ω .

RDS-ID setup:

Follow the next steps to set up the RDS-ID of MOSFET by referring to the corresponding number in Figure 3-20.

1. Select "MOSFET" as the device type.
2. Check the "RDS-ID".
3. Open the drain detail setup, and then set as follows:
 - UHCU as the measurement module.
 - Set IPulse mode.
 - Sweep.
 - Number of step = 61.
 - Compliance = 37 V.
 - Check the voltage compliance.
 - Voltage compliance = 1 V.
 - Pulse delay = 50 μ s.
 - Pulse width = 200 μ s.
4. Set the Drain / Collector Current Pulse Sweep as follows:
 - Start = 10 A.
 - Stop = 300 A.

Note:

The voltage compliance is determined not to exceed the SOA of the device with the maximum current and the pulse width.

Compliance is determined by the maximum current and the maximum RDS to be measured as following.

$$\text{Compliance} = (\text{RDS} + \text{Rout}) \times \text{max. Current}$$

Here, Rout is the output resistance of the UHCU (120 m Ω at 500 A range, 40 m Ω at 1500 A range).

5. Open the gate detail setup, and then set as follows:
 - MCSMU as the measurement module.
 - Set VPulse mode.
 - Set step mode.
6. Set the Gate/Base Current Staircase Sweep as follows:
 - ListSingle.
 - Set 6.5 V, 10 V and 12 V.
7. Check the Auto Period.

8. Open the General detail setup, and then set as follows:
 - Aperture = 50 μ s.
 - Hold Time = 0 s.
9. Click the start measurement button.
10. RDS-IDV graph is drawn as shown in Figure 3-21.
11. Click the marker icon to show marker on the measurement curve.
12. Move the marker to 300 A on the trace of VGS = 12 V.
13. The marker reading shows as (an example),
 - ID = 300.51 A.
 - RDS = 1.43 m Ω .

Figure 3-20 RDS-ID setup.

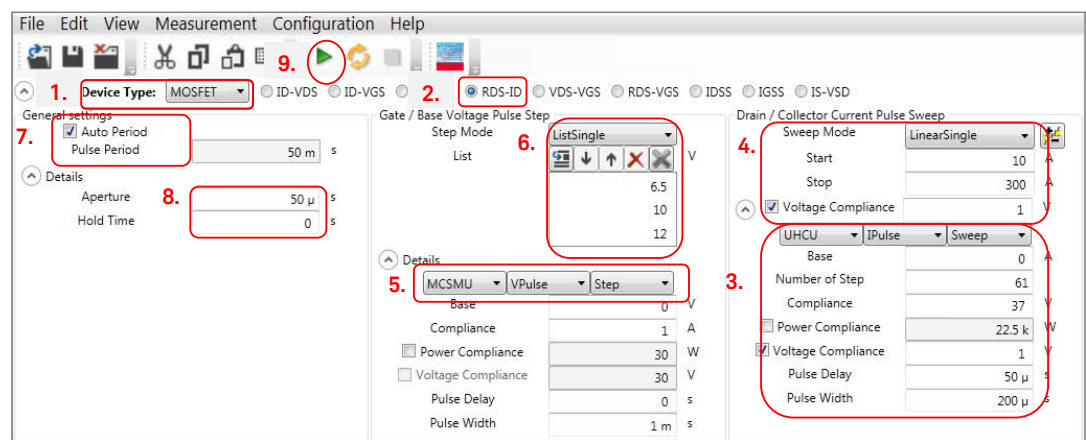
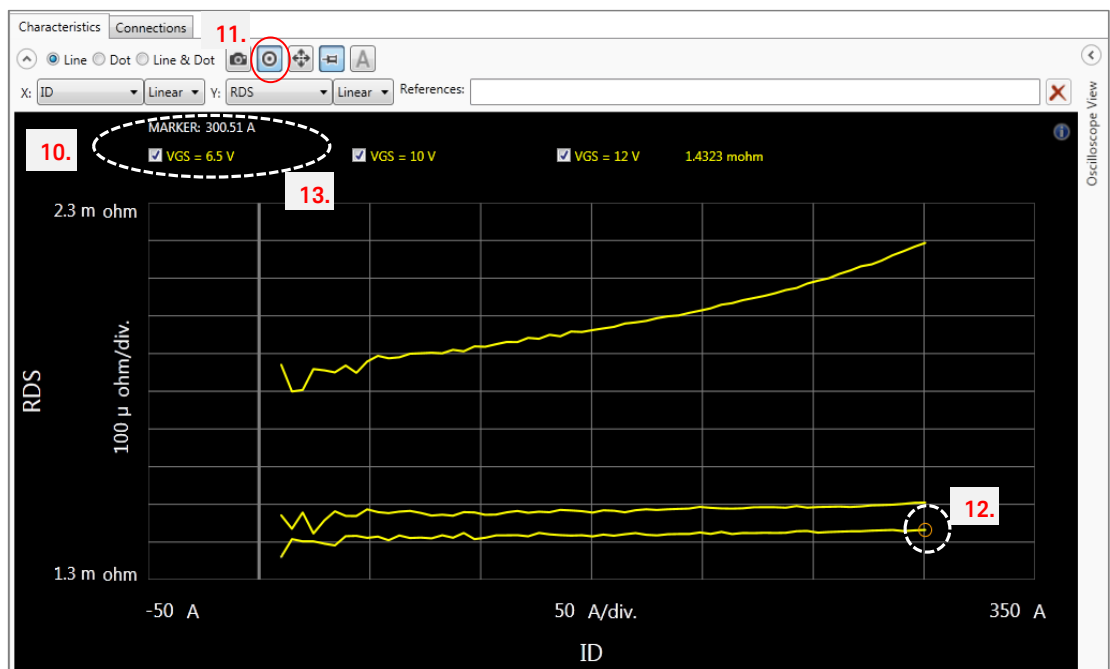

Figure 3-21 RD-IDS test result.



6. VDS-VGS, RDS-VGS power MOSFET characteristics

In this example, the discrete power MOSFET IRFP4004, which is the same device used in the previous example, is used.

In this example, we would like to measure the VDS-VGS characteristics with several ID steps as following.

- VGS: 15 V to 5 V.
- ID: 50 A, 100 A, 200 A.
- VDS: up to 2 V.

Note: VDS-VGS characteristics is useful to find the minimum VGS to keep conduction loss as small as possible, the same as the VCE-VGE characteristics of IGBT.

Note: The RDS-VGS setup uses almost the same setup as the VDS-VGS and RDS uses as Y axis instead of VDS (= ID x RDS). To measure the RDS-VGS characteristics, select the RDS-VGS as the measurement template instead and use the same setup as for the VDS-VGS described in this section.

VDS-VGS setup:

Follow the next steps to set up the ID-VGS of the MOSFET by referring to the corresponding number in Figure 3-22.

1. Select "MOSFET" as the device type.
2. Check the "VDS-VGS".
3. Open the drain detail setup, and then set as follows:
 - UHCU as the measurement module.
 - Set IPulse mode.
 - Set Step mode.
 - Compliance = 26 V.
 - Check the voltage compliance.
 - Voltage compliance = 2 V.
 - Pulse delay = 50 μ s.
 - Pulse width = 200 μ s.
4. Set the Drain/Collector Current Pulse Step as follows:
 - 50 A, 100 A, 200 A

Note: The voltage compliance is determined not to exceed the SOA of the device with the maximum current and the pulse width.

Compliance is determined by the maximum current and the maximum VDS to be measured as following.

Compliance = VDS + Rout x max. Current

Here, Rout is the output resistance of the UHCU (120 m Ω at 500 A range, 40 m Ω at 1500 A range).

5. Open the gate detail setup, and then set as follows:
 - MCSMU as the measurement module.
 - Set VPulse mode.
 - Set Sweep mode.
 - Number of steps = 101.
 - Compliance = 1 A.
 - Pulse width = 1 m.s
6. Set the Gate/Base Current Staircase Sweep as follows:
 - Linear Single.
 - Start = 15 V.
 - Stop = 5 V.

Note:

The gate voltage sweep should start from large voltage to small voltage (on state to off state). If it starts from small voltage, the measured VDS reaches to the voltage compliance at the first point and measurement is aborted after that.

7. Check the Auto Period
8. Open the General detail setup, and then set as follows:
 - Aperture = 50 μ s
 - Hold Time = 0 s
9. Click the start measurement button.
10. VDS-VGS graph is drawn as shown in Figure 3-23.
11. Click the marker icon to show marker on the measurement curve.
12. Move the marker to the corner on the trace of ID = 200 V.
13. The marker reading shows as (an example),
 - VGS = 5.8 V.
 - VDS = 713.5 mV.

From the result, at least 5.8 V of the gate voltage Step Mode is required to turn on the device with 200 V of the drain current.

Figure 3-22 VDS-VGS setup.

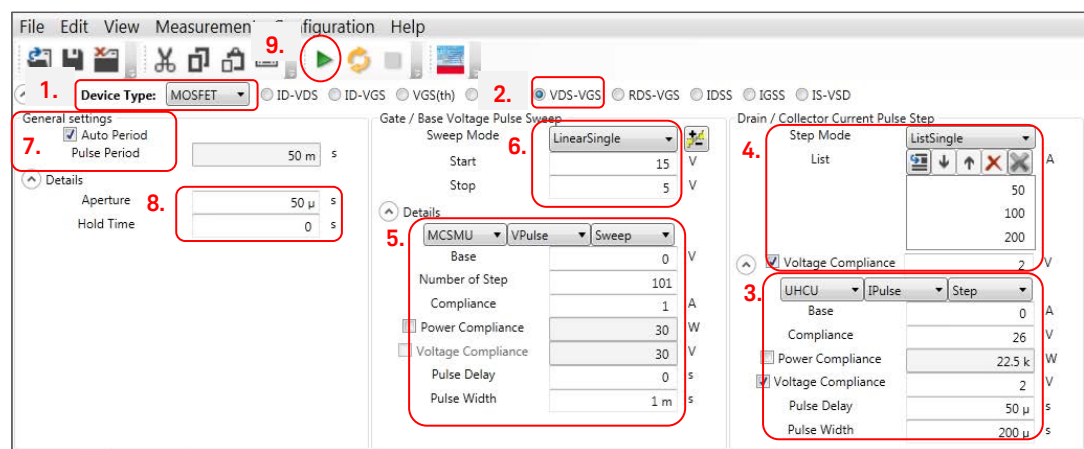
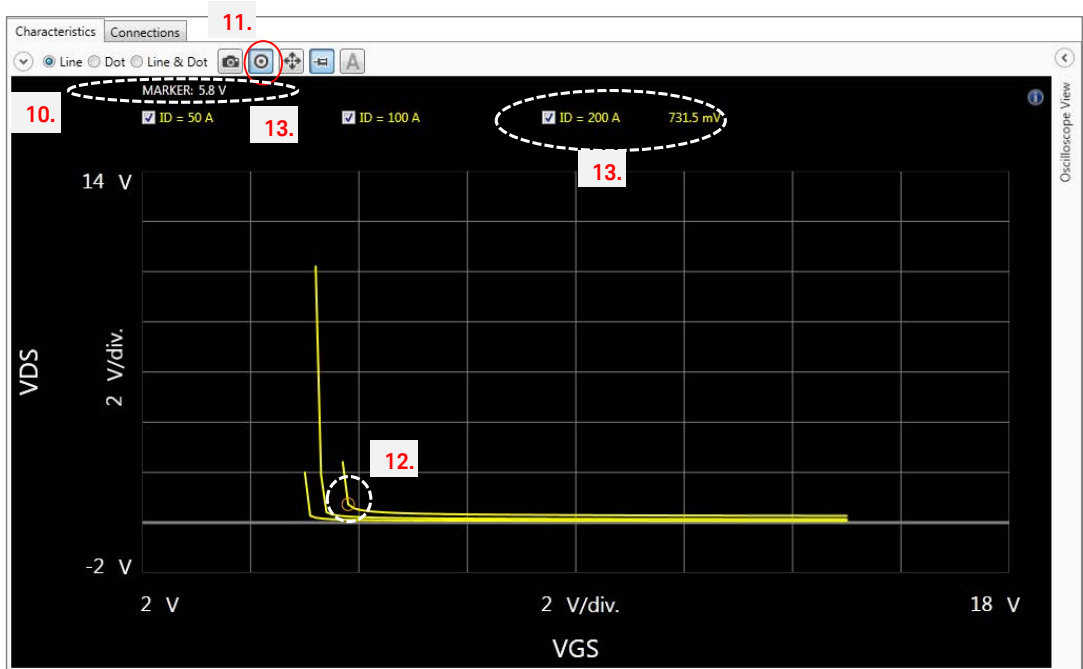

Figure 3-23 VDS-VGS test result.



Note: In Figure 3-23, the VDS exceeds the specified voltage compliance in the Drain/Collector Current Pulse Setup (step 3).

Since the voltage compliance function skips the consequent measurement after MEASURED value exceeds the compliance, at least one measurement point exceeds the compliance. To see how the voltage compliance works, change the display mode of the trace as shown in Figure 3-24.

- 14. Check “Dot” as trace mode,
- 15. 2 V line of the voltage compliance

Figure 3-24 Voltage compliance on VDS-VGS measurement

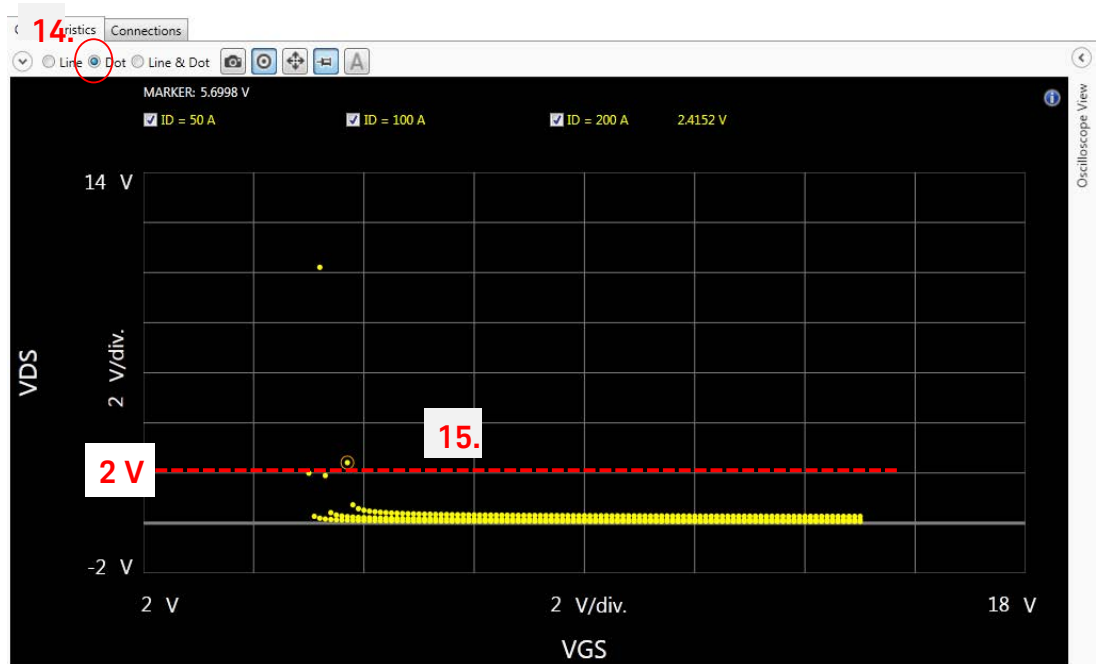

The amount of excess depends on a derivative of the trace. In VDS-VGS characteristics, the derivative of the trace near the compliance is significantly large, so the measured VDS goes up to 10 V. To reduce the overrun, it is necessary to increase the step of number as much as possible. Also, specifying appropriate compliance is useful.

The compliance limits the output from the voltage source of the UHCU. In the setup, 26 V compliance limits the VDS at 14 V when $I_D = 100\text{ A}$ ($26\text{ V} - 120\text{ m}\Omega \times 100\text{ A}$) physically. $120\text{ m}\Omega$ is a value of the output resistance of the UHCSU at 500 A range.

7. IDSS power MOSFET characteristics

In this example, the discrete power MOSFET IRFP4004, which is the same device used in the previous example, is used.

In this example, we would like to measure the drain leakage current characteristics by sweeping the drain bias as follows;

- VDS: 0 V to 50 V.
- VGS: 0 V.
- ID: compliance at 250 μ A.

IDSS setup:

Follow the next steps to set up the drain leakage current measurement of the MOSFET by referring to the corresponding number in Figure 3-25.

1. Select "MOSFET" as the device type.
2. Check the "IDSS"
3. Open the drain detail setup, and then set as follows:
 - HVSMU as the measurement module.
 - Set V mode.
 - Set Sweep.
 - Number of step = 51.
 - Compliance = 250 μ A.
4. Set the Drain/Collector Current Pulse Sweep as follows:
 - Sweep mode: LinearSingle.
 - Start = 0 V.
 - Stop = 50 V.
5. Open the gate detail setup, and then set as follows:
 - MPSMU as the measurement module.
 - Set V mode.
 - Set Constant mode.
 - Compliance = 1 mA.
6. Set the Gate/Base Voltage Bias as follows:
 - Source = 0 V.
7. Set the general settings as follows:
 - Trace Mode as Fine.
 - NPLC = 1.
8. Open General detail setup, and then set as follows:
 - Delay time = 0 s.
 - Hold Time = 0 s.
9. Click the start measurement button.
10. ID-VDS graph is drawn as shown in Figure 3-26.
11. Click the marker icon to show marker on the measurement curve.
12. Move the marker to the end of the trace.
13. The marker reading shows as (an example),
 - ID = 250 μ A
 - VD = 45.24 V

Figure 3-25 Drain leakage current measurement setup.

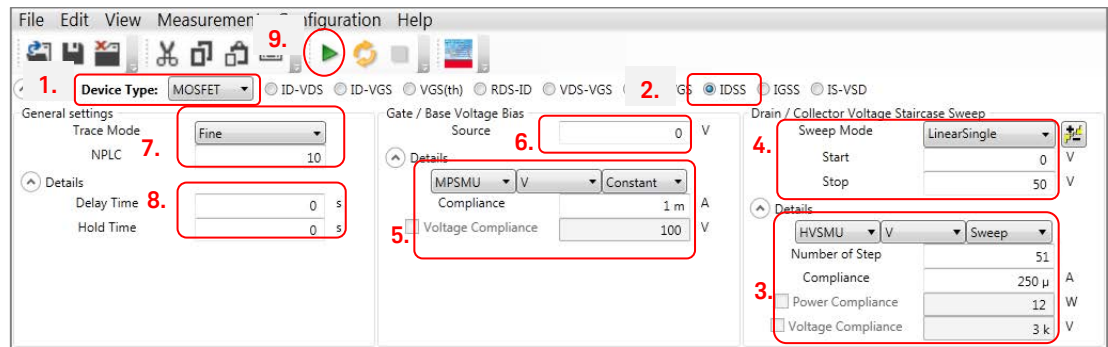
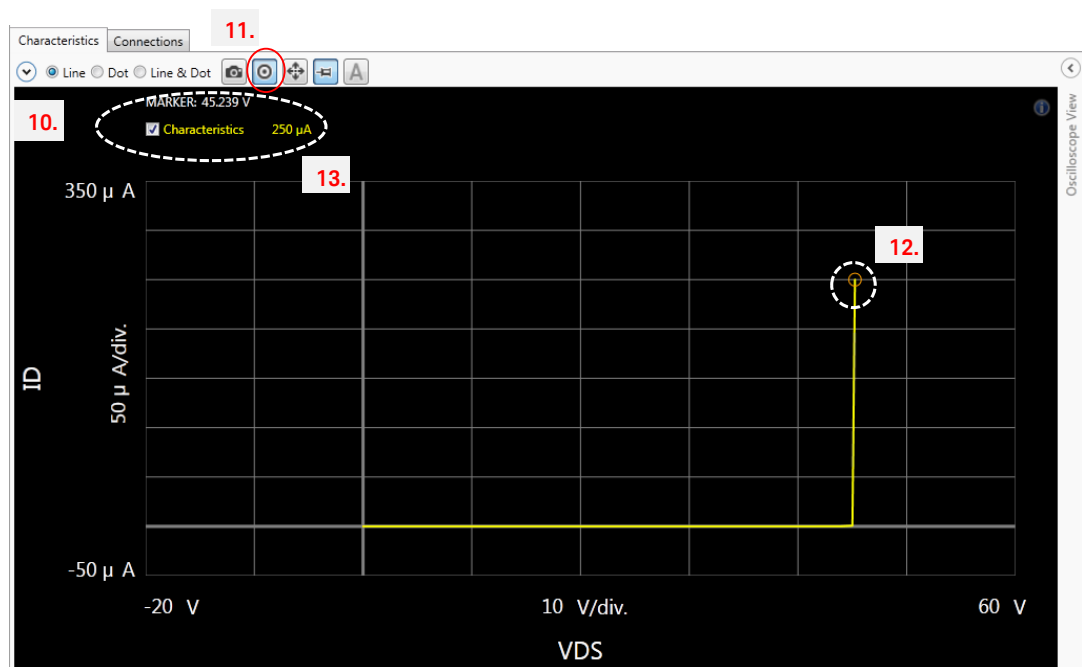

Figure 3-26 Drain leakage current test result.



By changing the scaling mode of the Y axis to log scale, it is possible to precisely see a small change on the drain leakage current as follows (Figure 3-27).

14. Change the display mode of the Y axis to PositiveLog, and a small change of the drain current under 1 nA can be observed clearly.

Figure 3-27 Drain leakage current in log scale.

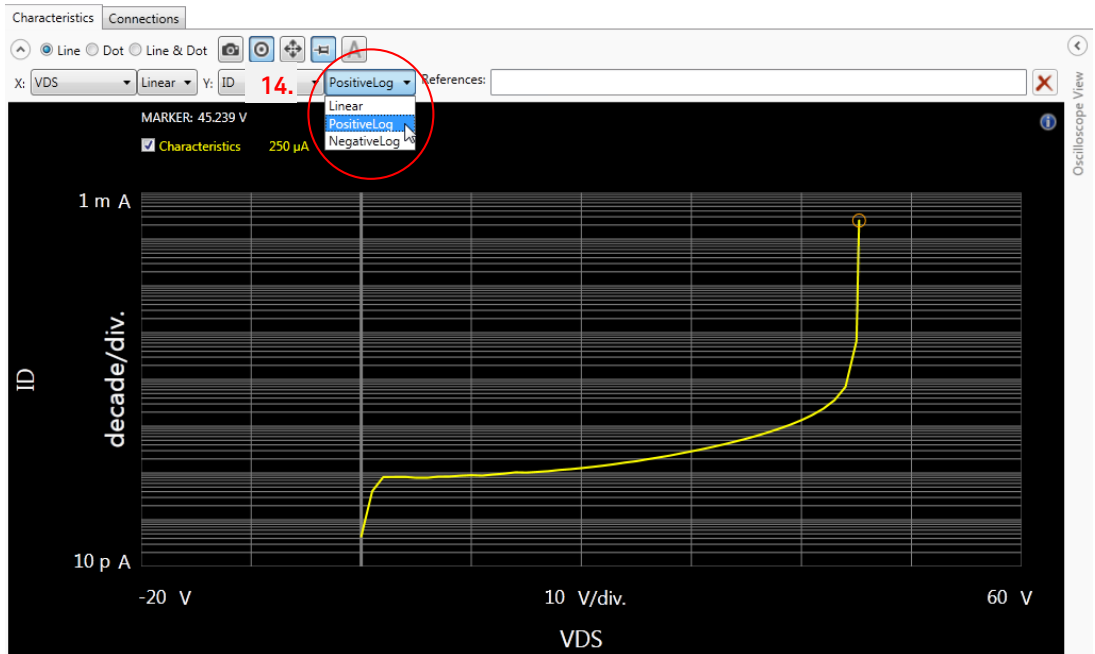

Tips:

If the breakdown voltage of the device is unknown and stop leakage current measurement before device is broken, interactive sweep using the knob on the front panel of the B1506A is useful.

Figure 3-28 shows the steps to run the drain leakage current measurement interactively.

15. Change the general settings as follows:
 - Set the Trace Mode as the quick mode.
 - Step time = 2.1 ms.
16. Set details of the general settings as follows:
 - Aperture = 2 ms.
 - Hold time = 100 ms
17. Click the repeat button.
18. Select the stop voltage of the Drain/Collector Voltage Staircase Sweep.
19. Rotate the knob - the end point of the trace changes along with the rotation of the knob.

Figure 3-28 Interactive drain leakage current measurement



By rotating the knob and monitoring the change of the drain leakage current, it is possible to identify any signs of breakdown and to stop increasing the drain voltage before the device breaks.

8. IGSS power MOSFET Characteristics

In this example, the discrete power MOSFET IRFP4004, which is the same device used in the previous example, is used.

In this example, we would like to measure the IG-VGS characteristics as follows:

- VGS: 0 V to 20 V (VGSS)
- IG: 1 μ A compliance.

IGSS setup:

Follow the next steps to setup the ID-VGS of the MOSFET by referring to the corresponding number in Figure 3-25.

1. Select "MOSFET" as the device type.
2. Check the "IGSS"
3. Open the drain detail setup, and then set as follows:
 - HVSMU as the measurement module.
 - Set V mode.
 - Set Constant mode.
 - Compliance = 8 mA.
4. Set the Drain/Collector Voltage Bias as follow:
 - Source = 0 V.
5. Open the gate detail setup, and then set as follows:
 - MPSMU as the measurement module.
 - Set V mode.
 - Set Sweep mode.
 - Number of steps = 201.
 - Compliance = 1 μ A.

Note: To reduce influence from settling after applying voltage at each step, a small step such as 100 mV is used. Also, to charge the gate capacitor faster, compliance current larger than IGSS (= 200 nA) is used in this example. When using a smaller compliance current, it is necessary to make the delay time longer.

6. Set Gate / Base Voltage Staircase Sweep as follows:
 - LinearSingle.
 - Start = 0 V.
 - Stop = 20 V.

Note: It is recommended to start the sweep from 0 V for precision IG-VGS measurement. If it starts from VGSS, it is necessary to add a significantly long Hold time (= additional delay time for the first step) to wait for a settling current after applying the gate voltage.

7. Set general setting as follows:
 - Trace mode as Fine.
 - NPLC = 10.

8. Open General detail setup, and then set as follows:
 - Delay Time = 500 ms.
 - Hold Time = 1 s.
9. Click the Start measurement button.
10. IG-VGS graph is drawn as shown in Figure 3-30.
11. Click the marker icon to show marker on the measurement curve.
12. Move the marker to VGS = 20 V.
13. The marker reading shows as an example (Figure 3-30).
 - VGS = 20 V.
 - IG = 7.48 pA.

Figure 3-29 IG-VGS gate leakage current measurement setup.

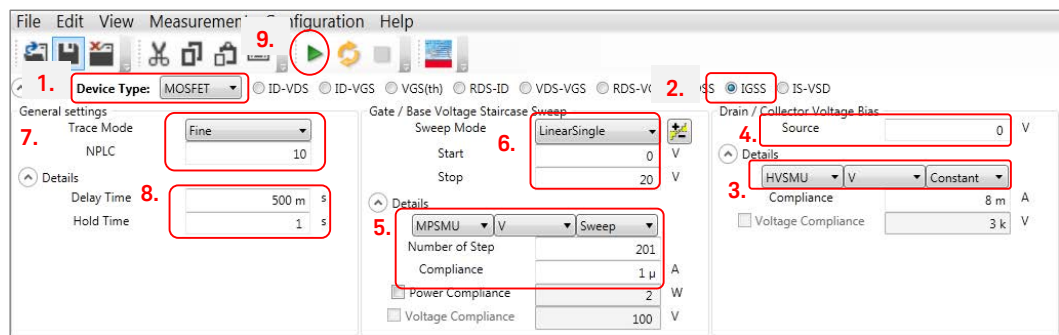
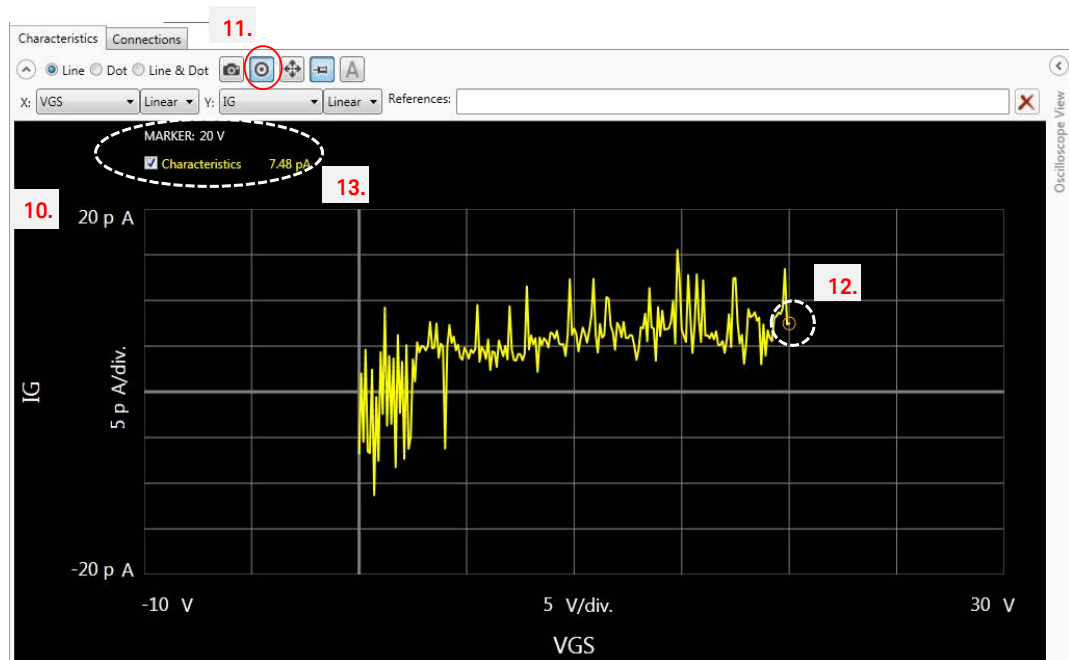

Figure 3-30 IG-VGS test result.



Note: Noise on IG in Figure 3-30 is considered to come from the noise on applied gate voltage converted by $C_g \times dV/dt$. To reduce it, it is necessary to use a longer integration time such as 32 PLC or more.

9. IS-VSS power MOSFET Characteristics

In this example, we would like to measure the IS-VSS, forward characteristics of the body diode as follows.

- VSD: 0 V to 2 V
- IS: 0 A to 500 A

IS-VS setup:

Follow the next steps to setup the IS-VS of the MOSFET by referring to the corresponding number in Figure 3-31.

1. Select "MOSFET" as the device type.
2. Check the "IS-VSD".
3. Open the drain detail setup, and then set as follows:
 - UHCU as the measurement module.
 - Set IPulse mode.
 - Sweep.
 - Number of step = 101.
 - Compliance = 500 A.
 - Check the voltage compliance.
 - Voltage compliance = 2 V.
 - Pulse delay = 50 μ s.
 - Pulse width = 200 μ s.
4. Set the Drain / Collector Voltage Pulse Sweep as follows:
 - Start 0 V.
 - Stop 60 V.

Note:

To apply the source current up to 500 A, the stop voltage of the sweep should be 60 V because the output current of the UHCU is determined by

$$\text{Output Current} = \text{Setting Voltage} / (\text{Rout} + \text{VSD})$$

Here, Rout is the output resistance of the UHCU (120 m Ω at 500 A range, 40 m Ω at 1500 A range). In this case, since the compliance current determines the output current range of the UHCU, the 120 m Ω output resistor is used (it is a nominal value and actual resistance has some margin to output 500 A with a small VSD).

5. Open the gate detail setup, and then set as follows:
 - MCSMU as the measurement module.
 - VPulse mode.
 - Constant mode.
 - Compliance = 1 A.
6. Set the Gate / Base Voltage Pulse Bias Staircase as follows:
 - ListSingle.
 - Source = 0 V.
7. Check the Auto Period.
8. Open the General detail setup, and then set as follows:
 - Aperture = 50 μ s.
 - Hold Time = 0 s.
9. Click the Start measurement button.
10. IS-VSD graph is drawn as shown in Figure 3-32.

Figure 3-31 IS-VSD setup.

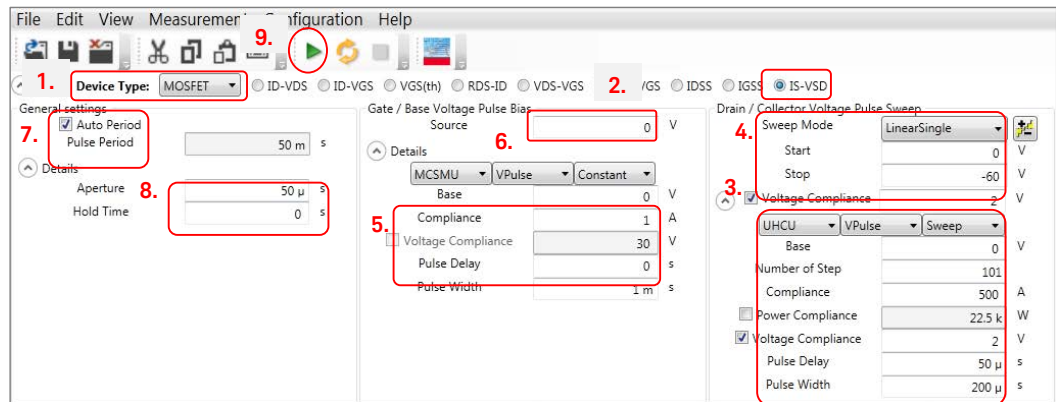
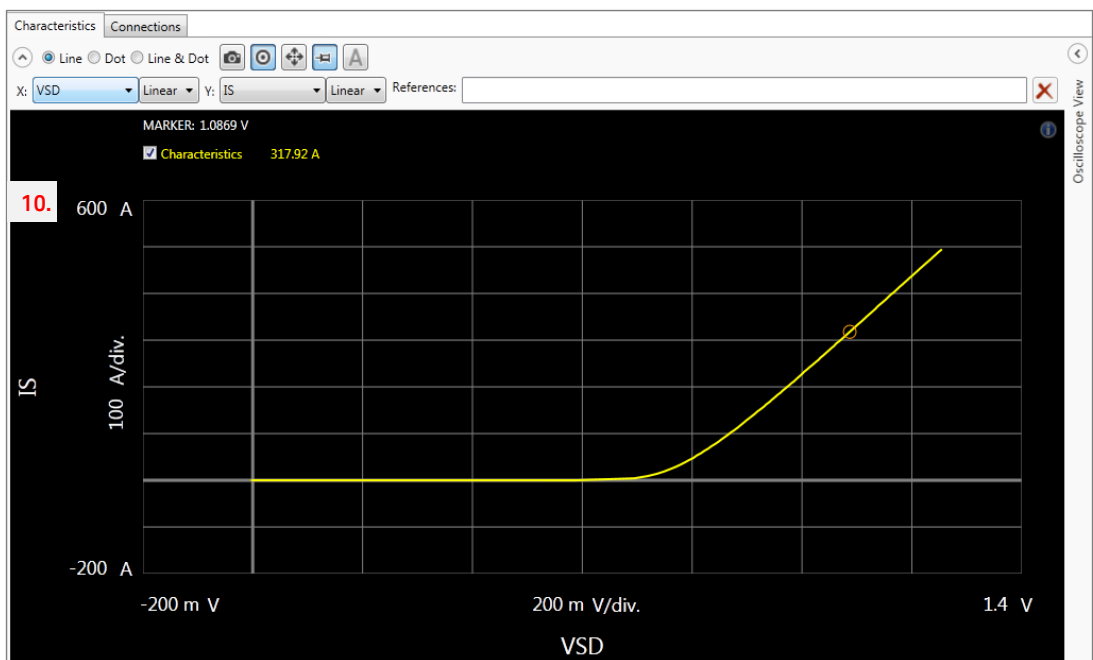
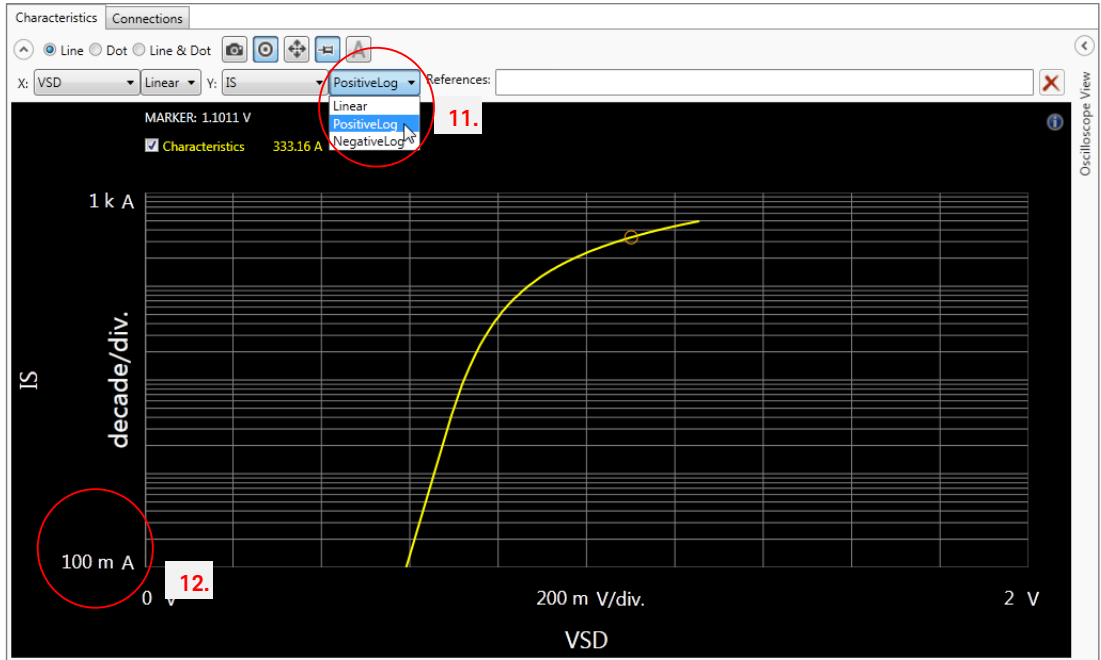

Figure 3-32 IS-VSD test result.



11. To display the IS-VSD in log scale, change scaling mode of the Y axis to "PositiveLog" (Figure 3-33).
12. Set the minimum value of the Y axis to 100 mA.

Figure 3-33 IS-VSD test result in log scale



10. IGBT module measurement

Some IGBT or FET modules are packaged into a large size module, and the connection is typically made with the screw type terminals.

To connect these modules to the B1506A, test leads with alligator clips are used as shown Figure 3-34 as an example of IGBT module.

The alligator clips used in this picture are included in the B1506A as the standard accessory.

Typically, this kind of module has additional emitter terminal to connect low side of the gate bias channel (Figure 3-35).

Figure 3-34 Example of the IGBT module connection.

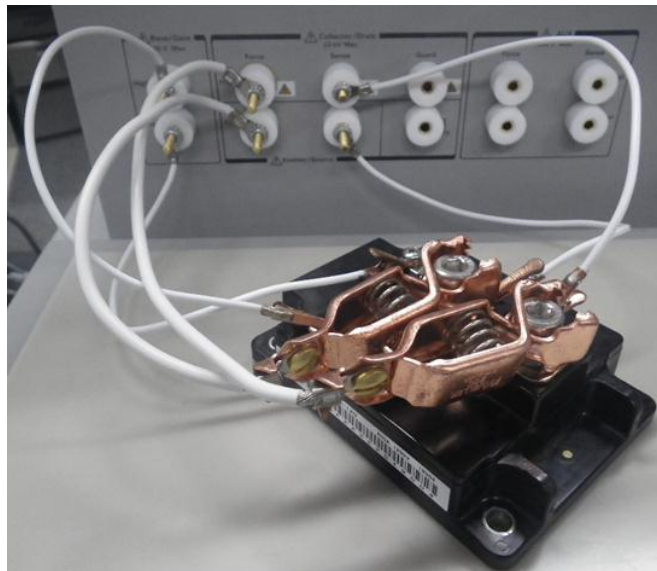
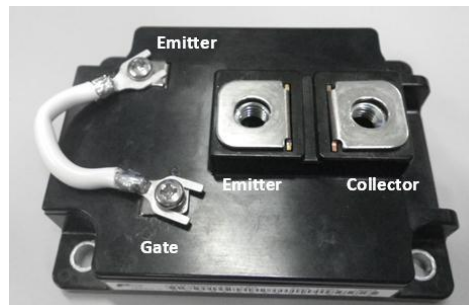

Figure 3-35 Additional emitter terminal to connect with the gate.



Connection with the B1506A

Figure 3-36 shows the cable connection of the B1506A test fixture. The output terminal of B1506A test fixture has high force, high sense, low force and low sense for the UHCU or HCSMU. Also, there are high and low terminal for gate drive.

How to connect the outputs of B1506A:

To connect the outputs of B1506A to the device terminal;

- ✓ Use thick cable with large clip to connect the high force and low force.
- ✓ Use narrow cable with small clip to connect the gate terminals and the sense terminals.

Figure 3-36

B1506A test fixture connection.

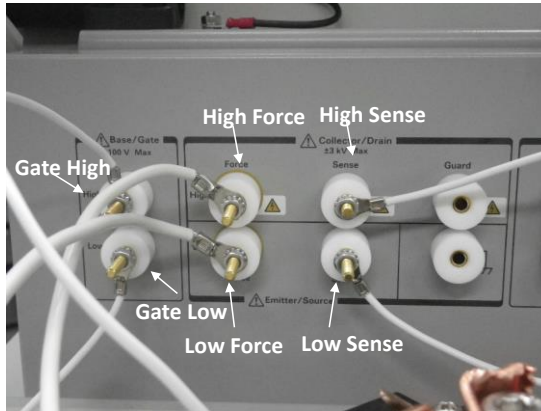

How to connect the cables to the module:

Figure 3-37 shows an example of cable connection to IGBT module.

1. Put screws to the device terminals to clip them.
2. Connect the gate high to the gate terminal of the device.
3. Connect the gate low to the smaller emitter terminal.
4. Connect the high force (4a) and high sense (4b) to the collector terminal.
5. Connect the low force and low sense to the emitter terminal.

Figure 3-37

The connection to the IGBT module.

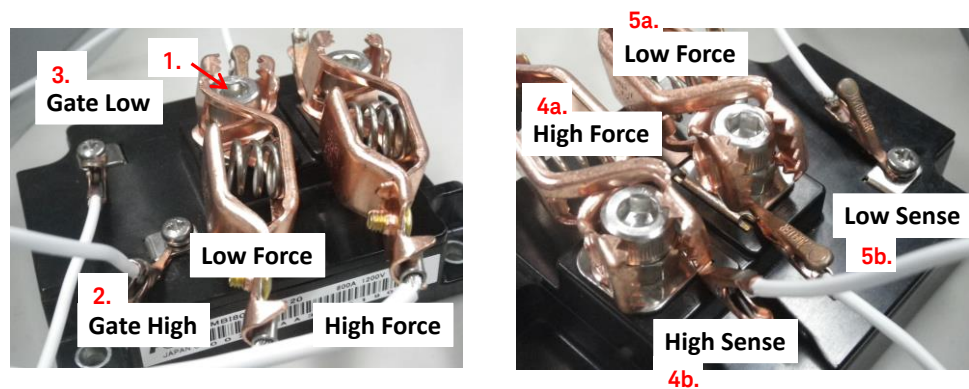

Tips: How to connect the high and low sense terminals to the device

When connecting the sense terminal to the High and Low terminal of the device module, connect them to the device side of the terminal by avoiding the paths where the High and Low force current flows. These connection methods minimize the voltage drop at the connection terminal, and assure a better accuracy.

An IGBT module measurement example

Figure 3-38 shows an example of module IGBT measurements.

Due to the 2.5 V of $V_{(ce) sat}$ of the device and the voltage drop by the residual resistance of cables (and clips), the maximum current is about 1.4 kA in this example.

Figure 3-38 Measurement example of IGBT module.

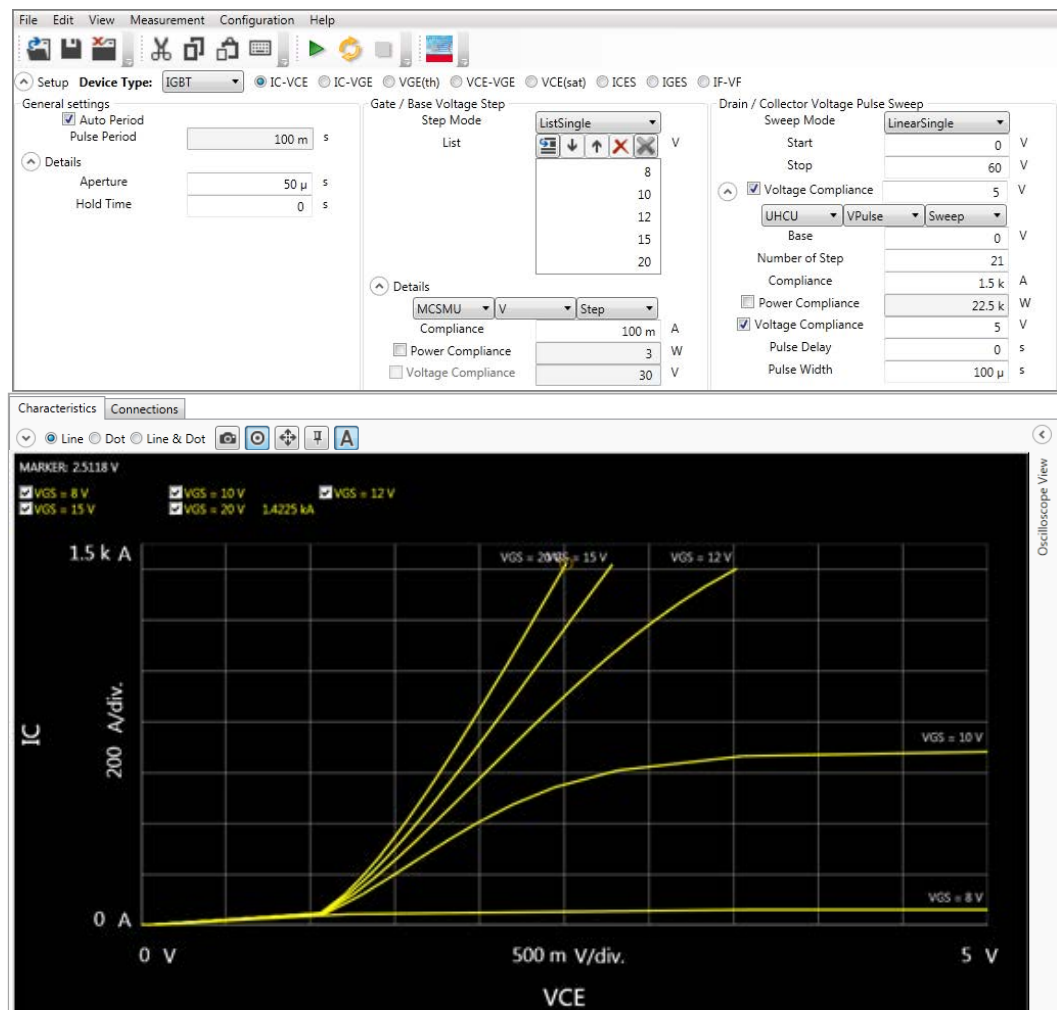

Tips

How to measure multiple devices module:

Some of IGBT module consists of multiple devices connected inside the module. Figure 3-39 shows such an example of 2-in-1 IGBT module. It includes two IGBT and the emitter of the high side device is connected to the collector of the low side device.

When one of the device is not in use in the measurement, the gate and the emitter of the unused device has to be shorted by shorting ring or shorting bar to avoid device damage by static electrical shock.

Figure 3-39 Connections for a measurement of the multiple devices module.

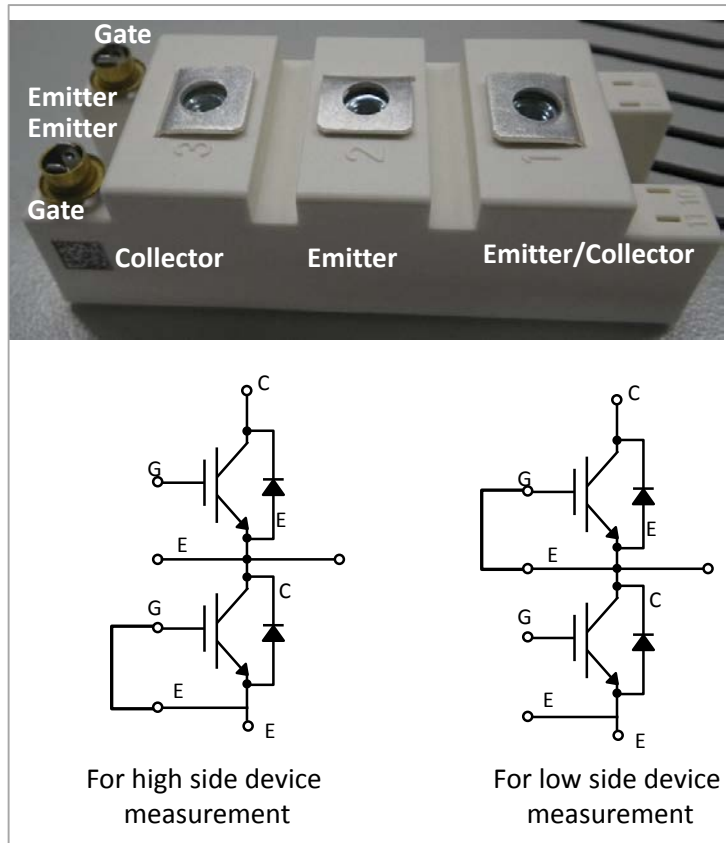

Useful information for using I/V measurement mode

The differences between the quick mode and the fine mode

In the IV measurement mode, two measurement modes are available, quick mode and fine mode.

The fine mode is available from Easy Test Navigator 2.0 and the quick mode is the mode used in previous revisions.

The fine mode is used for precision measurement such as subthreshold current measurement of the MOSFET. It uses limited auto ranging to use an appropriate measurement range while larger compliance is specified. Also, Maximum 100 PLC mode of integration time is used to reduce a measurement noise coming from the commercial power source (PLC stands for Power Line Cycle. 1 PLC is equivalent to 20 ms in 50 Hz region and 16.67 ms in 60 Hz region).

The quick mode uses fixed ranging defined by specified compliance value. Measurement speed of the quick mode is faster than the fine mode, and it is useful to change the bias voltage interactively by using the rotating knob on the front panel of the B1506A like a cure tracer.

The fine mode is only available when DC bias mode (V or I) is used for all measurement resources.

Table 3-7 shows a comparison of the minimum current measurement resolutions of the quick mode and the fine mode.

Since the fine mode uses limited auto ranging mode, the minimum resolution is determined by only the minimum current measurement range.

Table 3-7

Minimum current measurement resolutions of the quick mode and the fine mode

Module	Current Compliance	Min. Resolution using the Quick Mode	Min. Resolution using the Fine Mode
MSPMU	100 mA	5 μ A	10 fA
	10 mA	500 nA	
	1 mA	50 nA	
	100 μ A	5 nA	
	10 μ A	500 pA	
	1 μ A	50 pA	
	100 nA	5 pA	
	10 nA	500 fA	
HVSMU	8 mA	10 nA	100 fA
	1 mA	1 nA	
	100 μ A	100 pA	
	10 μ A	10 pA	
	1 μ A	1 pA	
	100 nA	100 fA	
	10 nA	100 fA	

The auto ranging allows you to use larger current compliance for low current measurement. For example, in the case of gate leakage current measurement, using large compliance makes it faster by shortening the time it takes to charge capacitive components. After charging the capacitor by using the compliance current, current measurement goes down to an appropriate range to measure the leakage. In the case of the quick mode, a smaller compliance current should be specified to measure low leakage current, but it requires a longer time to charge the capacitor (ex. to charge 1 nF gate capacitor to 20 V with 1 nA compliance, it requires 20 seconds or more).

Figure 3-40 shows the differences on timing control of measurements between the fine mode and the quick mode.

Figure 3-40

Definitions of measurement time of the fine mode and the quick mode

(a) Quick mode

(b) Fine mode

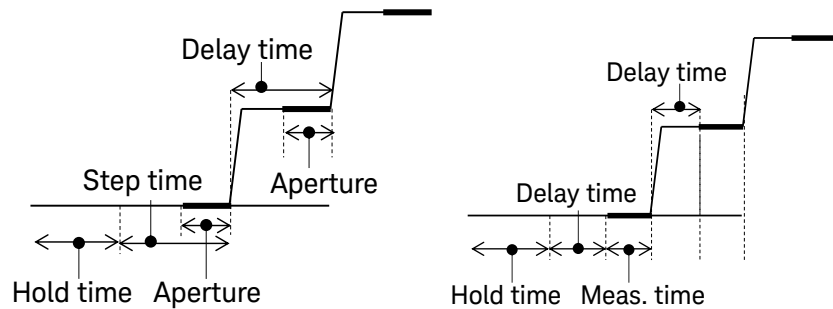

Timing of source and measurement in the quick mode is defined as the step time and the aperture. The step time is controlled by the firmware. Delay time to start measurement is determined by Step Time – Aperture.

In the fine mode, the step time cannot be controlled precisely. Step time is determined by Delay Time + Measurement Time. Measurement time consists of built-in wait time, range changing time and integration time. Since the built-in wait time and the range changing time vary by measurement conditions, the step time also varies by measurement conditions.

The fine mode uses the NPLC mode of measurement time. NPLC stands for number of power line cycles (1 PLC = 20 ms @ 50 Hz region, 16.67 ms @ 60 Hz region) and it is effective to reduce measurement noise coming from the commercial power line. Also, to reduce a random noise on measured data, using multiple NPLCs as the measurement time such as 8 PLC or 16 PLC is effective.

How to avoid device oscillation

To avoid device oscillation of MOS and IGBT devices, inserting a series resistor to the gate terminal is useful. B1506A has built-in selectable series resistance in the gate connection path.

How to select the gate series resistance:

Figure 3-41 shows the gate resistor setup example.

1. Show the connections panel by clicking the connection tab on the graph area.
2. Select an appropriate resistance from the list. 0 Ω , 10 Ω , 100 Ω and 1 k Ω are available.
3. For the drain/collector connection, 0 Ω and 100 k Ω are available.

Figure 3-41 Selecting the gate and collector series resistance.

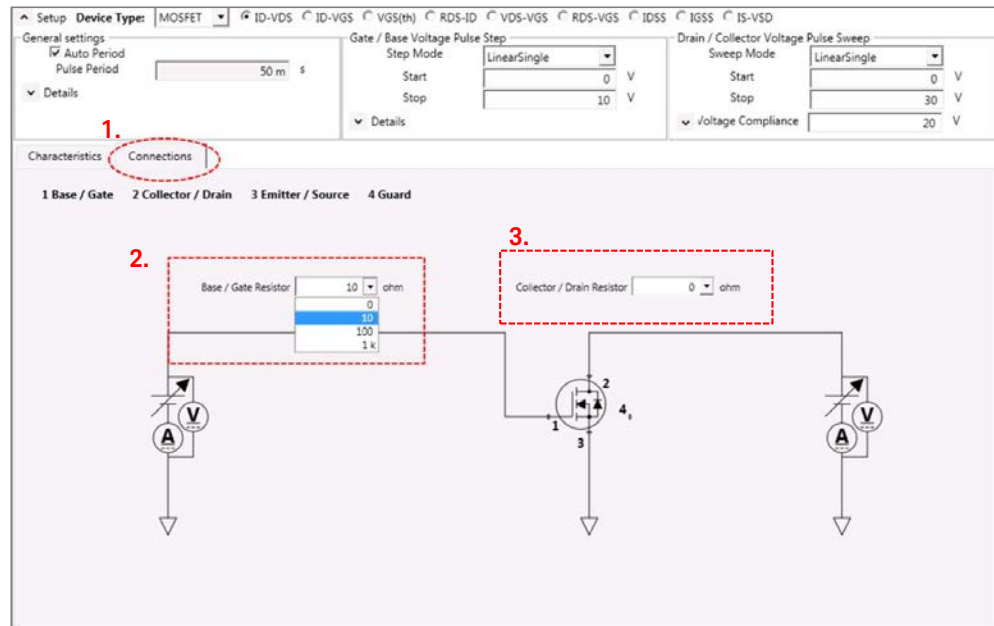

Accurate measurement using a narrow pulse

The MOSFET typically shows higher on resistance and lower drain current at specific test condition when the junction temperature is getting higher. The datasheet data specified at 25 °C junction temperature is typically measured using a very narrow pulse.

This section provides information and the tips of how narrow pulse can be used in the IV measurement to reduce the self-heating of the test device, and measures a closer data which is shown in a datasheet.

Note for super junction MOSFET:

Typically, the default pulse width is too long to measure a kind of super junction MOSFET. Super junction MOSFET is a new kind of power MOSFET which has relatively high current and high voltage ratings.

Super junction MOSFET example

Figure 3-42 shows an ID-VDS measurement example measured with two different pulse width; one 30 μs, and the other with 200 μs pulse width.

In the small ID area, both ID curves show almost the same trace, but the ID curve apparently decreases at higher current and higher voltage with 200 μs pulse compared to the 30 μs pulse. In the area where both the VDS and the IDS are high, the power consumed by the transistor is maximum, say 20 V x 60 A = 1200 W. The temperature of the transistor chip rises sharply after applying this high power, and the ID starts to decrease from just after applying the power.

The difference of two ID curves at around 20 V VDS at 60 A ID area show the effect of this chip temperature rise, and the ID with 200 μs pulse shows lower value.

Oscilloscope View:

Figure 3-43 shows the same measurement with the Oscilloscope View in the right side, which is taken with 200 μs pulse width at VD = 20 V and the VG = 20 V test point.

You can monitor the pulse waveforms of both the current and the voltage for both the drain and the gate using the Oscilloscope View.

The monitoring parameter can be set in the area "a.", and the corresponding parameter display scale can be set in the area "b.".

By monitoring the pulse waveform, for example, you can judge if the test parameter is appropriate or not.

Figure 3-42 An ID-VDS measurement example of a super junction MOSFET.

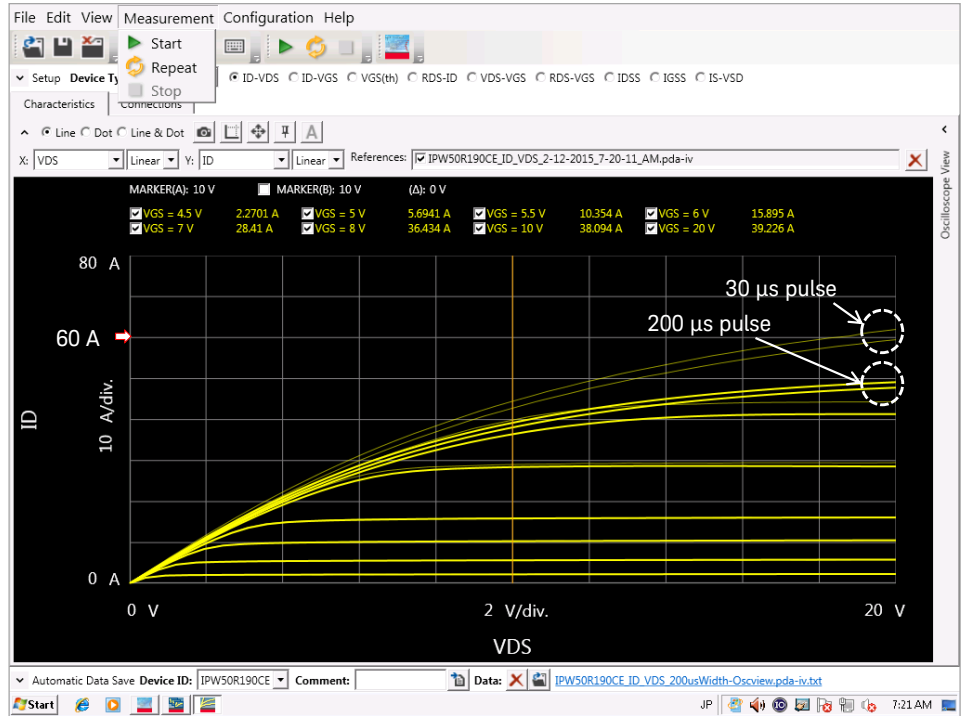
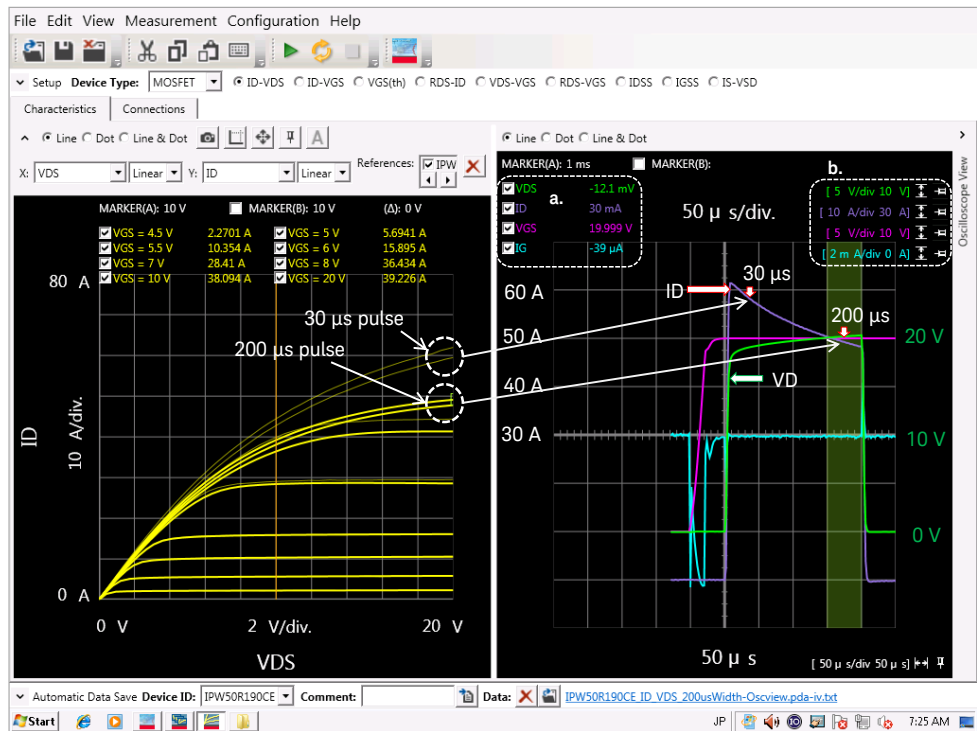

Figure 3-43 An ID-VDS measurement waveform and the IV data relation.



Pulse width determination:

From the ID waveform of the 200 μs pulse, the following points can be judged as;

- ✓ It is about 10 A lower at 200 μs point compared to 30 μs point.
Note: The VD start time is set as 0 seconds in this case.
- ✓ At 30 μs , the ID waveform is stably decreasing, and the VD rises up almost to the final 20 V.
Therefore, it can be judged that using 30 μs pulse is reasonable than 200 μs pulse.
- ✓ Maybe considering shorter pulse width is also worth.
Note: When measuring with shorter pulse, it requires more attention to the other parameters such as the aperture time and the delay time settings.
There may be a case that a pulse parameter for a specific IV condition is not appropriate for other IV condition.

Figure 3-44 shows 20 μs pulse example with 2 μs aperture time. The ID reading increases to 64 A.

Figure 3-44

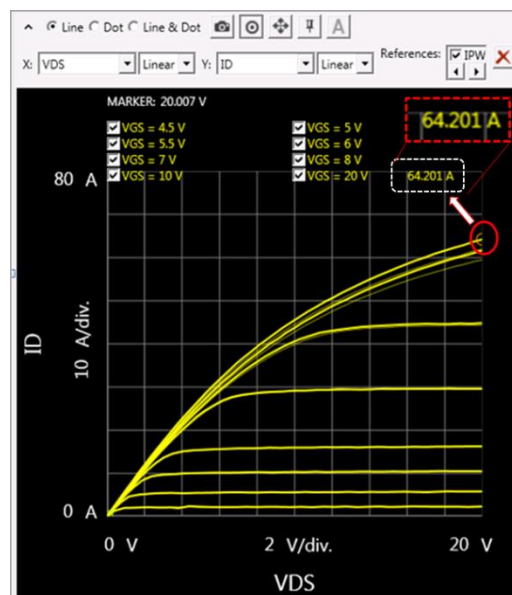
An ID-VDS measurement with 20 μs pulse.**Tips:****Criteria of determining the minimum pulse width:**

The minimum rise time (T_r) of the VD is determined by the following formula. The minimum pulse width can be determined by adding the aperture time to the obtained T_r as:

$$\text{Minimum pulse width} > T_r + \text{aperture time}$$

The T_r is determined by the UHCU's current range and the R_{on} of the test device.

- ✓ $I_D < 500 \text{ A}$
 $T_r = 5 \times 1 \mu\text{H} / (R_{on} + 120 \text{ m}\Omega)$
- ✓ $I_D \geq 500 \text{ A}$
 $T_r = 5 \times 1.4 \mu\text{H} / (R_{on} + 40 \text{ m}\Omega)$

Example:

The R_{on} of the example super junction FET is 170 m Ω (typ.).

$$T_r = 5 \times 1.0 \mu / (170 \text{ m} + 120 \text{ m}) \\ = 17 \mu\text{s}$$

By adding 2 μs aperture time,

$$\text{Min. pulse width} = 17 + 2 = 19 \mu\text{s}.$$

It can be considered the 20 μs pulse width used in the example is appropriate from the calculation.

Note:

Always determine the minimum pulse width by using the pulse waveform of the Oscilloscope View.

The minimum pulse width formula is convenient to know the idea of the minimum pulse width.

But, checking the real waveform is the basic of the successful pulsed measurement, especially pursuing a shortest pulse width.

4. Capacitance Measurement

Overview	228
The capacitance measurement template	230
Measurement parameters of each device type	231
Measurement frequency consideration	233
Measurement error examples	234
How to open the capacitance measurement mode	238
Capacitance measurement mode examples	239
Notes before starting measurements	239
Capacitance measurement calibration	239
1. Ciss, Coss, Crss MOSFET characteristics	240
Low voltage measurement.....	241
2. Rg internal gate resistance characteristics of Power MOSFET	243
3. IGBT module measurement example and tips	246
IGBT module connection.....	246
IGBT / MOSFET module (multi-chip module).....	246
Useful information for using capacitance measurement mode.....	248
Crss measurement of super junction FET	248
Commonly seen problem in Crss measurement.....	248
100 kHz solves the negative Crss measurement problem	249
Capacitance compensation data measurement	251
Rg measurement with the open or voltage biased drain/collector	255
Vgs accuracy improvement by self calibration	259

Overview

The capacitance measurement mode is used to measure static capacitance characteristics of power devices.

Capacitance measurement using the B1506A is quite simple, and the measurement can be done with the following simple steps.

1. Connect the device to the socket adapter or output of the module selector.
2. Set measurement parameters.
3. Clicking start measurement button measures the capacitance parameters of power devices.

The function and the operation of the capacitance measurement mode are basically the same as the characteristics graph of the datasheet characterization mode where the pre-defined measurement setup opens when you click on the target characteristics graph.

Capacitance parameters:

Typical capacitance parameters of power devices are not always the same as the physical parameters of the device terminal capacitances (Cgd, Cgs, Cds as an example) as shown next. It requires some interpretation to convert them to the datasheet parameters. For example, Ciss is sum of Cgd and Cgs device terminal capacitances.

Power MOSFET:

Device terminal capacitance:

- ✓ Cgs: Gate to source capacitance
- ✓ Cgd: Gate to drain capacitance
- ✓ Cds: Drain to source capacitance

Capacitance parameter described in datasheet:

- ✓ Ciss: Input capacitance
- ✓ Coss: Output capacitance
- ✓ Crss: Reverse transfer capacitance

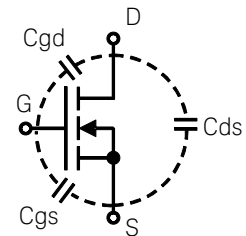

$$C_{iss} = C_{gd} + C_{gs}$$

$$C_{oss} = C_{gd} + C_{ds}$$

$$C_{rss} = C_{gd}$$

IGBT:

Device terminal capacitance:

- ✓ Cge: Gate to emitter capacitance
- ✓ Cgc: Gate to collector capacitance
- ✓ Cce: Drain to emitter capacitance

Capacitance parameter described in datasheet:

- ✓ Cies: Input capacitance
- ✓ Coes: Output capacitance
- ✓ Cres: Reverse transfer capacitance

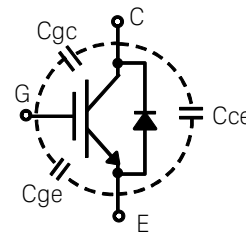

$$C_{ies} = C_{gc} + C_{ge}$$

$$C_{oes} = C_{gc} + C_{ce}$$

$$C_{res} = C_{gc}$$

In the B1506A, "Device capacitance unit" inside the B1506A test fixture converts the connection to directly measure the datasheet parameters.

"Device capacitance unit" consists of switchable AC block resistances and AC short capacitances to measure typical capacitance parameters of power devices.

Note:

These capacitance measurement techniques are introduced in "Capacitance measurement techniques" of "Measurement Theory and Detail Explanation of the Measurement Capability" section of Chapter 2.

Gate resistance parameter:

In addition to the above capacitance parameters, the internal gate resistance of power MOSFET and IGBT can be measured. The internal gate resistance is measured as a series resistance of the C_{gs} of power MOSFET or C_{ies} of IGBT measurement using R_g parameter measurement, which uses the series model (Cs-Rs) of LCR meter.

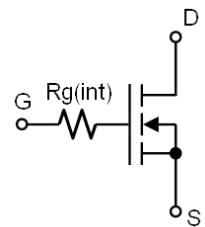

The drain-source or collector-emitter is shorted in the default measurement setting, but a bias voltage to the Drain/Collector terminal can be also applied.

Oxide capacitance parameter:

To evaluate a capacitance of gate oxide (C_{ox}), C_{iss} measurement is used

Two bias supply voltages:

B1506A device capacitance switch provides an additional bias-T to apply gate voltage during the capacitance measurement by applying drain/collector bias voltage. Because of this capability, a normally-on type device can be measured, too.

The capacitance measurement template

Figure 4-1 shows an example capacitance measurement setup template. Refer to the corresponding number in the figure for following explanations for the template.

1. There are five choices in the device types.
 - MOSFET
 - IGBT
 - Diode
 - Generic

2. There are a few selections of measurement template in each device type. The figure shows the selection of the MOSFET measurement template. Refer to the following section for supported measurement templates.

3. In the capacitance measurement mode, all the measurement setup parameters are opened to you, and you have to set all the necessary measurement parameters by yourself.

Figure 4-1 Example of the capacitance measurement template.

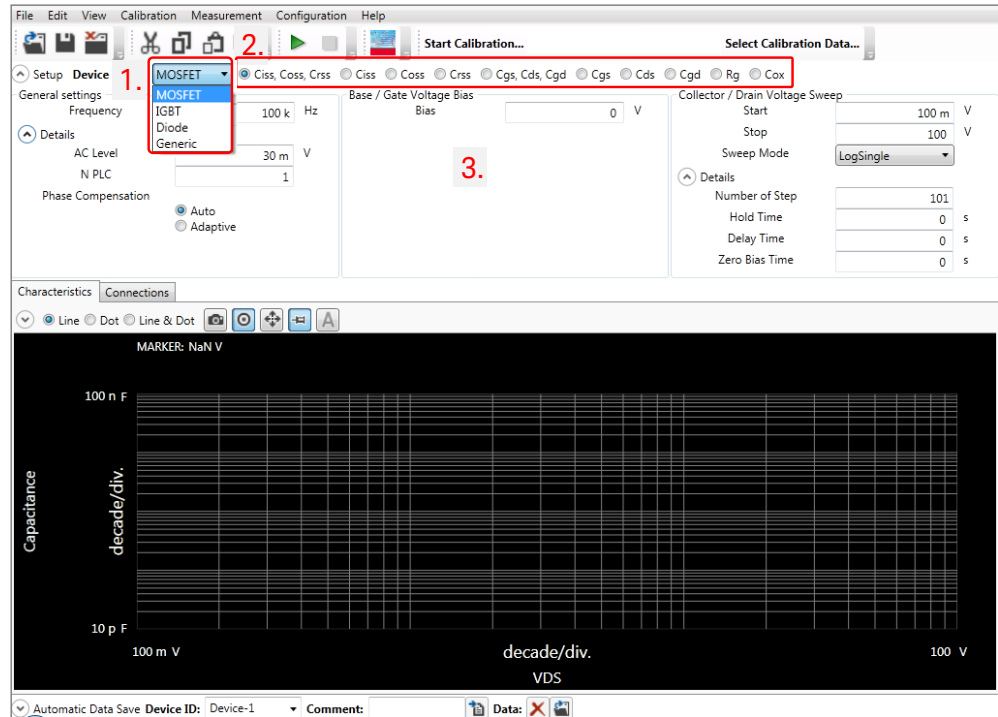

Measurement parameters of each device type

Capacitance Measurement parameters

Capacitance Measurement mode supports the following device types and device characteristics.

Device Type: MOSFET:

- ✓ Ciss, Coss, Crss
- ✓ Ciss
- ✓ Coss
- ✓ Crss
- ✓ Cgs, Cds, Cgd
- ✓ Cgs
- ✓ Cds
- ✓ Cgd
- ✓ Rg
- ✓ Cox

Device Type: IGBT:

- ✓ Cies, Coes, Cres
- ✓ Cies
- ✓ Coes
- ✓ Cres
- ✓ Cge, Cde, Cgc
- ✓ Cge
- ✓ Cce
- ✓ Cgc
- ✓ Rg

Device Type: Diode:

- ✓ CT (Total Capacitance)

Device Type: Generic:

- ✓ Sweep Voltage Between Terminal 2-3
- ✓ Sweep Voltage Between Terminal 1-3

Figure 4-2 shows a connection diagram when selecting “Sweep Voltage Between Terminal 2-3” in the generic type. Terminals 1 to 4 correspond to the output terminal of the B1506A as,

- ✓ Terminal 1: Base/Gate
- ✓ Terminal 2: Collector/Drain
- ✓ Terminal 3: Emitter/Source
- ✓ Terminal 4: Guard

Figure 4-2 A connection diagram of a “Sweep Voltage Between Terminal 2-3”.

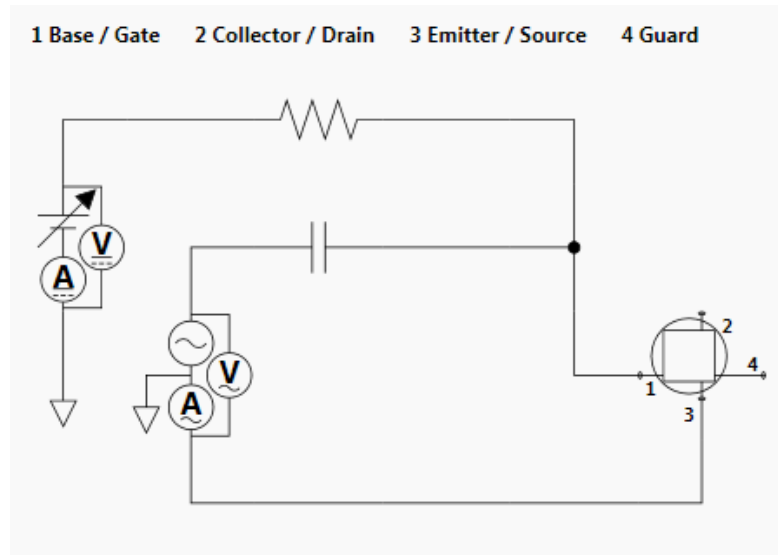

Measurement frequency consideration

Following describes the relation of the measurement accuracy and the measurement frequency.

Using 100 kHz test frequency provides a better accuracy in general, but widely used 1 MHz can be also used by understanding the additional errors explained in this section.

Note:

Recommended 100 kHz measurement frequency

A 100 kHz measurement frequency is recommended in the B1506A where the device capacitance switch is used. Due to the residual inductance of the switching system, the measurement error increases in the measurement at 1 MHz test frequency.

This error increases especially in the following cases,

- ✓ Ciss measurement of large scale device (ex. IGBT module).
- ✓ Crss measurement when Crss is significantly smaller than Ciss (ex. Super Junction MOSFET, GaN FET).

Since the test result measured by 100 kHz has less error and the CV characteristics does not have remarkable frequency dependency up to 1 MHz, 100 kHz measurement frequency is set as a default measurement frequency in the capacitance measurement template.

In the case when the test result at 1 MHz test frequency does not show significant difference from the 100 kHz test result, using 1 MHz test frequency should be okay. Else it is better to use the test result measured using the 100 kHz test frequency.

Measurement error examples

Following shows two typical error cases for C_{iss} and C_{gd} ($=C_{rss}$).

Case 1: C_{iss} (@ $C_{gs}:C_{ds}:C_{gd} = 1:1:1$), in the case for $V_{ds} = 0 V$

Figure 4-3 shows the C_{iss} capacitor measurement range versus test frequency when the measurement errors from 0.5% to 20% are set as the error parameter. The ratio of the capacitor components is set as $C_{gs}:C_{ds}:C_{gd} = 1:1:1$ (the same value for all the capacitor components), and this condition is simulating the case as $V_{ds} = 0 V$.

The 1 MHz error range is narrower compared to the 100 kHz, but can be used for both frequencies in a wide range of the capacitor.

Figure 4-3

C_{iss} measurement ranges at $C_{gs}=C_{gd}=C_{gd}$

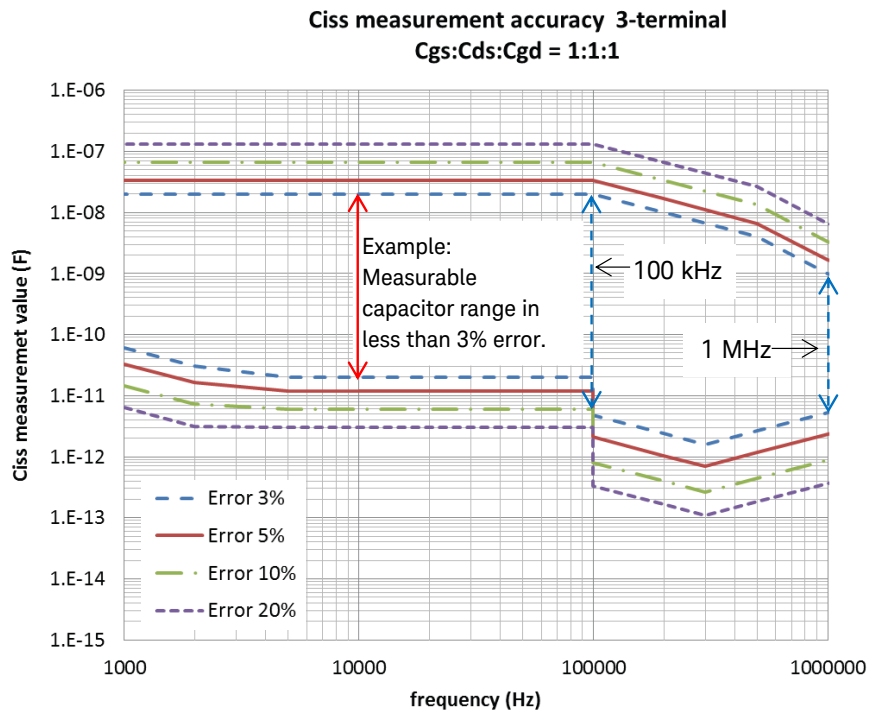

Case 2: Ciss (@ Cgs:Cds:Cgd = 1:0.1:0.01), in the case for Vds = high voltage

Figure 4-4 shows the Ciss measurement range assuming the drain voltage is high where the Ciss (=Cgd) becomes much smaller than the other capacitor components. The Ciss measurement range does not change because the largest Cgs component does not change by the drain voltage.

Figure 4-4

Ciss measurement ranges at Cgs:Cgd:Cgd = 1: 0.1:0.01

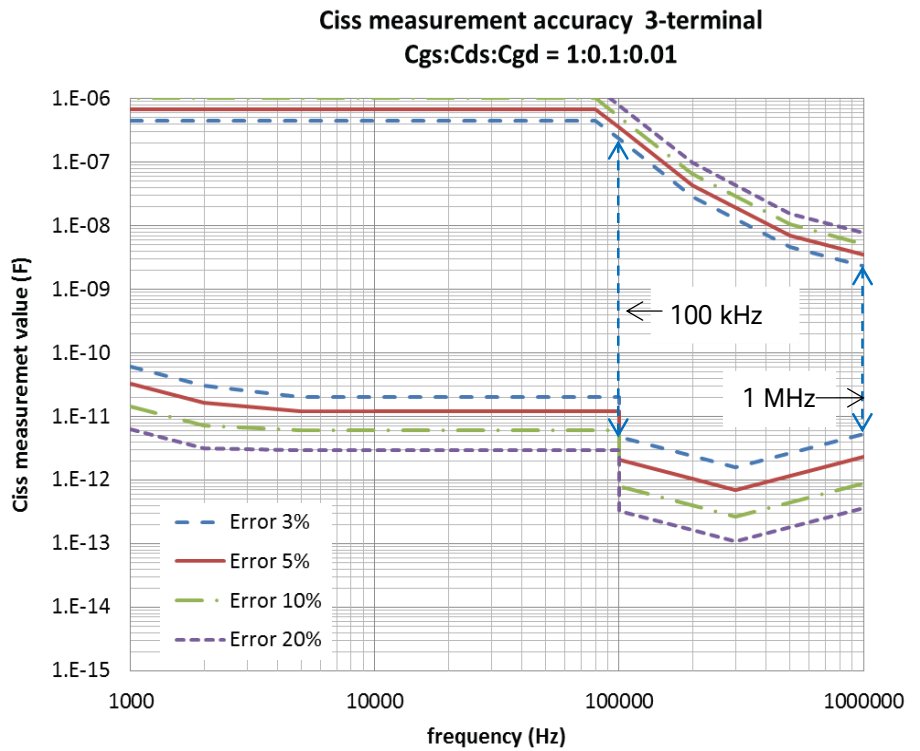

Case 3: Crss (@Cgs:Cds:Cgd = 1:1:1) in the case for Vds = 0 V

Figure 4-5 shows the Cres capacitor measurement range versus test frequency when the measurement errors from 0.5% to 20% are set as the error parameter. The ratio of the capacitor components is set as Cgs:Cds:Cgd = 1:1:1 (the same value for all the capacitor components), and this condition is simulating the case as Vds = 0 V.

Figure 4-5

Cgd (Crss) measurement ranges at Cgs=Cgd=Cgd.

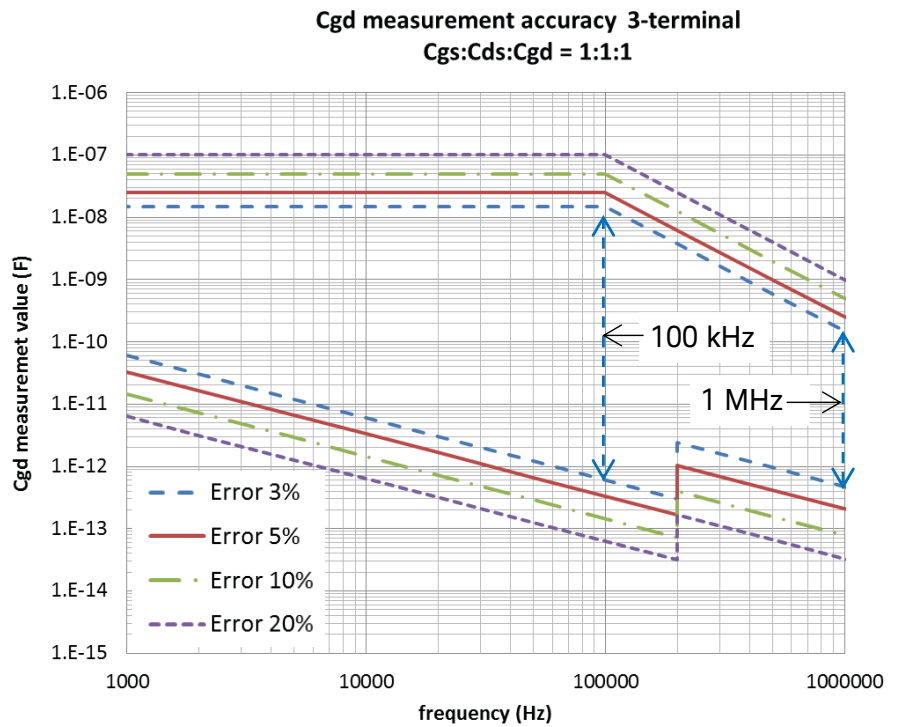

Case 4: Crss (@Cgs:Cds:Cgd = 1:0.1:0.01) in the case for Vds = high voltage

Figure 4-6 shows the Cres capacitor measurement range assuming the drain voltage is high where the Ciss (=Cgd) becomes much smaller than the other capacitor components.

The 1 MHz error range is too narrow, and measurement at 1 MHz frequency is not realistic in most of the devices.

100 kHz is not wide enough, but can be used as the default 100 kHz test frequency. In a device with larger Cgd, consider to use 10 kHz.

Figure 4-6

Cgd(Cres) measurement ranges at Cgs:Cgd:Cgd = 1: 0.1:0.01.

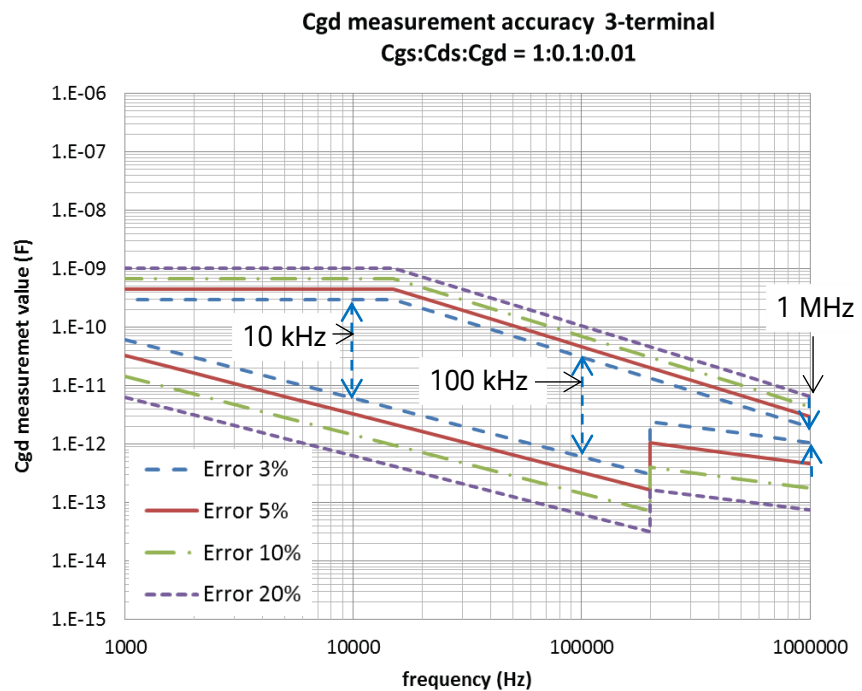

As shown in these example error graphs, Crss measurement becomes more critical in the error in the case where Vds is at high voltage. At high Vds, Crss (= Cgd) becomes significantly smaller than Cgs. In such a situation, the error estimated at Cgs:Cds:Cgd = 1:0.1:0.01 indicates an expected measurement error.

Reference:

Capacitance measurement techniques

The basic theory of capacitance measurement techniques are introduced in the "**Measurement theory and detail explanation of the measurement capability**" section in Chapter 2.

How to open the capacitance measurement mode

The capacitance measurement mode is started from the Easy Test Navigator as shown in Figure 4-7.

- ✓ Click on “Capacitance Measurement” to start the template.
- ✓ The capacitance measurement template shown in Figure 4-1 opens.

Figure 4-7 Capacitance Measurement mode startup from Easy Test Navigator.

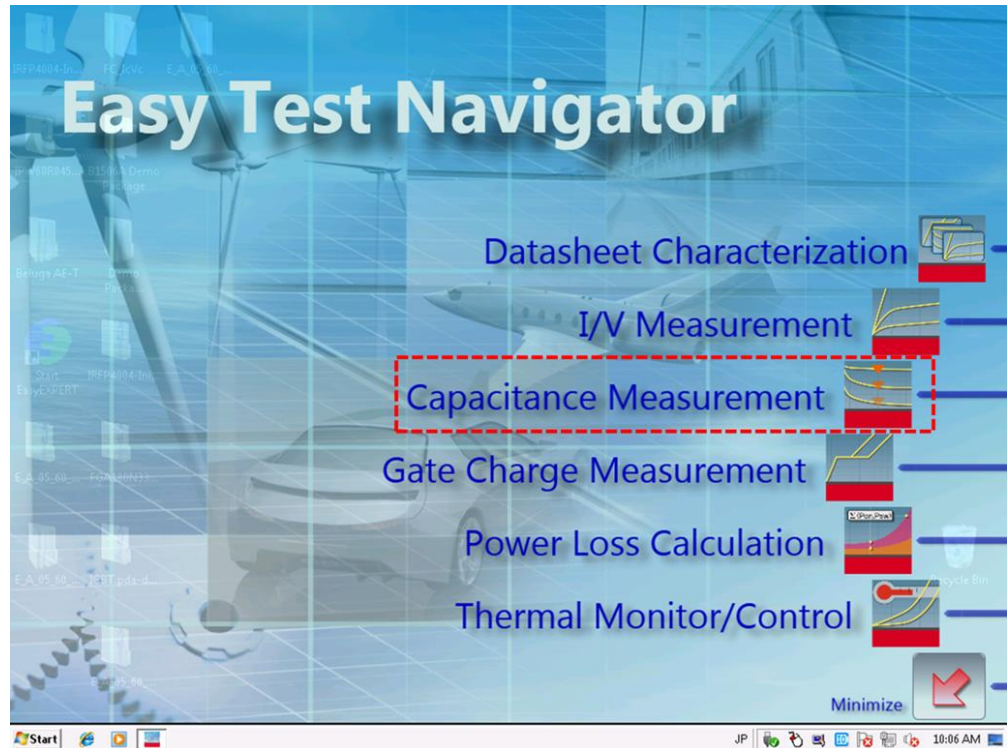

Capacitance measurement mode examples

Following example measurements are shown as the demonstration of the Capacitance Measurement mode.

1. Ciss, Coss, Crss MOSFET characteristics
2. Rg gate resistance characteristics of Power MOSFET
3. IGBT module measurement

Notes before starting measurements

If the device breaks during measurement at high voltage (over few hundreds volts), there is a risk to damage the capacitance switch or measurement module in the B1506A.

The risk is highest when the 1 μ F AC short capacitance is used to measure Ciss, Cgs, Cies or Cge.

Important Notice: To avoid damaging the B1506A

Please make sure that the voltage sweep range does never exceed the voltage rating of the device to measure.

If the device is an unknown device, it is strongly recommended to measure the breakdown voltage (VDSS or VCES) of the device first by using the IV measurement function of Easy Test Navigator.

Capacitance measurement calibration

Compensation data of the device capacitance switch at the output terminals of the B1506A test fixture are pre-installed in the system. However, when attaching adapters or the test leads to the test fixture, it is necessary to perform calibration to measure compensation factors for such extra parts for accurate capacitance measurements.

Compensation data of possible switch combinations are automatically measured and stored in the file. Once the compensation factors are loaded to the program, they are effective until the new compensation data is loaded.

Refer to "**Capacitance compensation data**", which is shown at the end of this chapter, for measuring the capacitance compensation data.

1. Ciss, Coss, Crss MOSFET characteristics

In this example, the discrete power MOSFET IXTH1N250 is used as the example test device. This device has the following basic characteristics.

- ✓ DUT: IXTH1N250
- ✓ VDSS: 2500V
- ✓ ID: max 1.5 A (pulse)



Figure 4-8

Sample capacitance data of IXTH1N250.

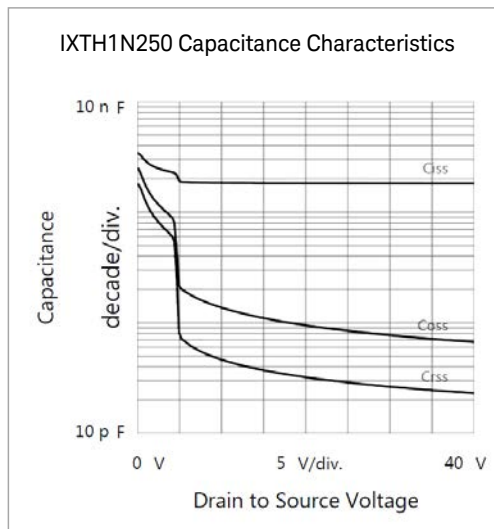

IXTH1N250
HV MOS

- ✓ Set the test device in the test fixture.

Figure 4-9

B1506A Opt. F10 3 pin Inline Package Socket Module.

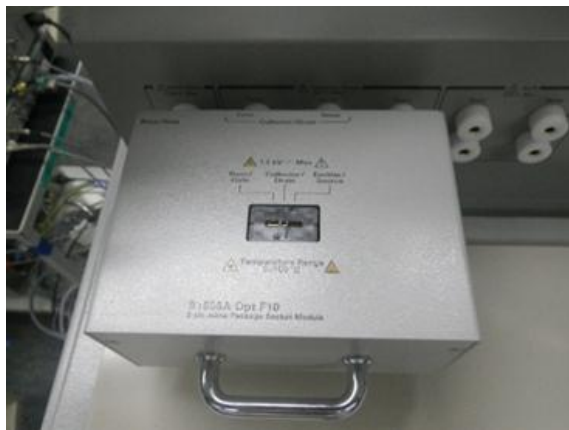

Low voltage measurement

Follow the next steps to set up the capacitance measurement by referring to the corresponding number in Figure 4-10.

- ✓ General Settings:
 1. Choose “MOSFET” as “Device Type”
 2. Check “Ciss, Coss, Crss”
 3. Set measurement frequency as 1 MHz.
- ✓ Base/Gate Voltage Bias:
 4. Confirm the gate voltage is 0 V to make the device turned off
- ✓ Collector/Drain Voltage Sweep:
 5. Sweep collector voltage from 0 V to 40 V.
 6. Select “LinearSingle” as “Sweep Mode”.
 7. Set 0 s as “Hold Time”
Set 0 s as “Delay Time”
Set 5 s as “Zero Bias Time”

Note: The Zero Bias Time is necessary to wait for recovery from the highly biased condition of the previous measurement like Coss measurement after Ciss measurement. This is required from some specific device (IXTH1N250 requires this from our experience).

Note: Delay time to charge the internal capacitance of the capacitance switch is automatically included, even if the delay time is not specified intentionally.

- ✓ How to start measurement:
 8. Click the “Measure” button to start the CV measurement automatically as shown in Figure 4-11.
Order of the measurement is fixed, and it starts from Ciss. Coss is measured next, and Crss measurement is done last.

Figure 4-10 Capacitance measurement setup.

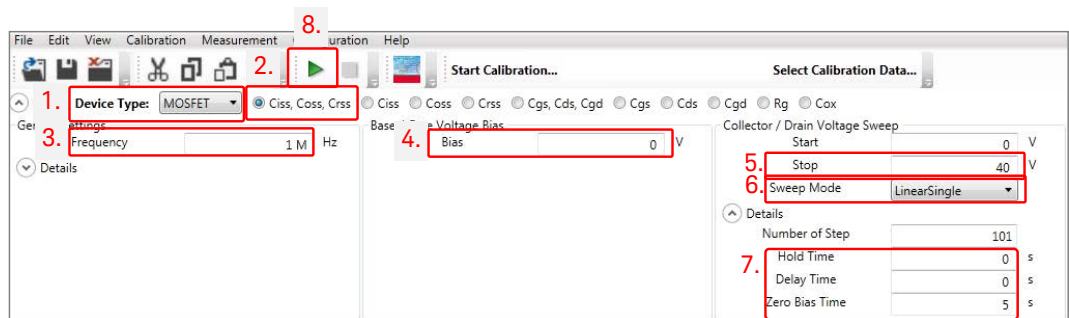
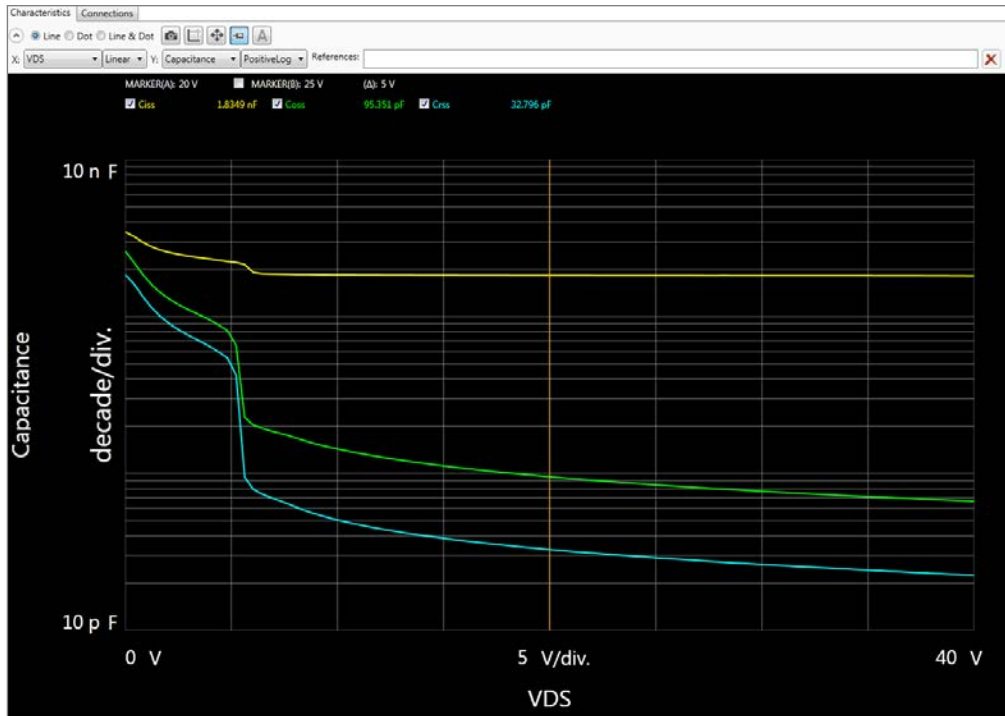

Figure 4-11 Capacitance measurement result.



Tips:

To avoid UNBALANCE status

When measuring a specific type of device, the LCR meter sometimes returns "UNBALANCE" status in a specific condition. In this case, choosing "Adaptive" of Phase Compensation in "Detail of the General setting" possibly resolves the situation, but the measurement speed will get slower. (Figure 4-12.)

Figure 4-12

Adaptive phase compensation setup.

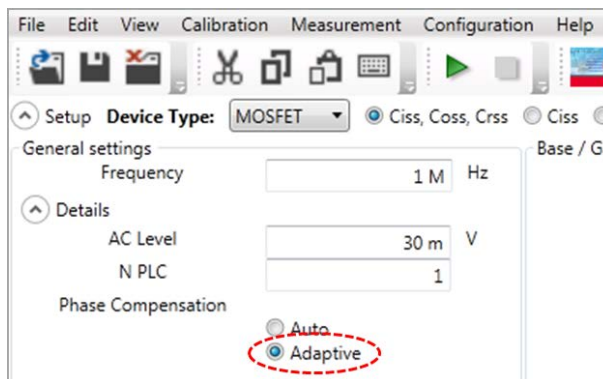

2. Rg internal gate resistance characteristics of Power MOSFET

In this example, IRFP4004 LDMOS-FET is used as the example test device.

This device has the following basic characteristics.

- ✓ DUT: , IRFP4004 LDMOS-FET
- ✓ VDSS: 40 V
- ✓ Rds(on): Typ. 1.35 m Ω @ Vgs=10 V)
- ✓ ID max.: 350A @ 100 μ s pulse, VD=10V
1390 A @ Vd=2.5 V
- ✓ Coss: 2360 pF typ. @ Vd=25 V
- ✓ Rg(int): 6.8 Ω typ.



IRFP4004
HC MOS

Follow the next steps to set up the Rg measurement by referring to the corresponding number in the Figure 2-53.

- ✓ Setup
 1. Choose "MOSFET" as device type
 2. Check "Rg".
- ✓ General settings
 3. Set 1 MHz as measurement frequency
 4. Set 16 PLC for precise measurement
- ✓ Base / Gate Voltage Sweep
 5. Leave as initial settings (-3 V to 3 V, LinearSingle)
- ✓ Collector / Drain Voltage Bias
 6. Leave as an initial setting (0 V)
- ✓ Click the measure button, and Rg is measured immediately.
(Refer to Figure 4-14)
Measured Rg at VGS = 0 V is 5.48 Ω .

Figure 4-13 Rg measurement setup.

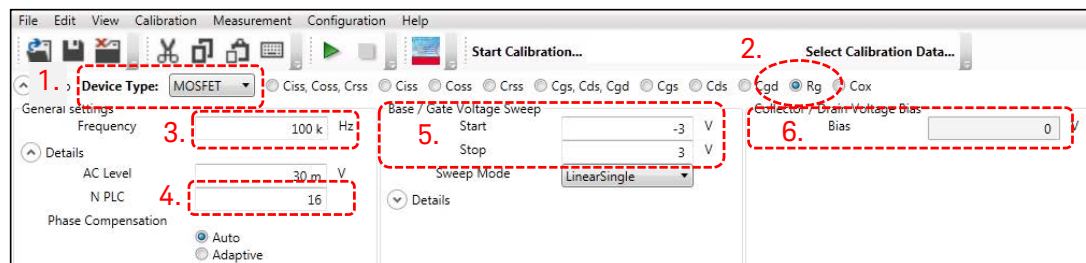
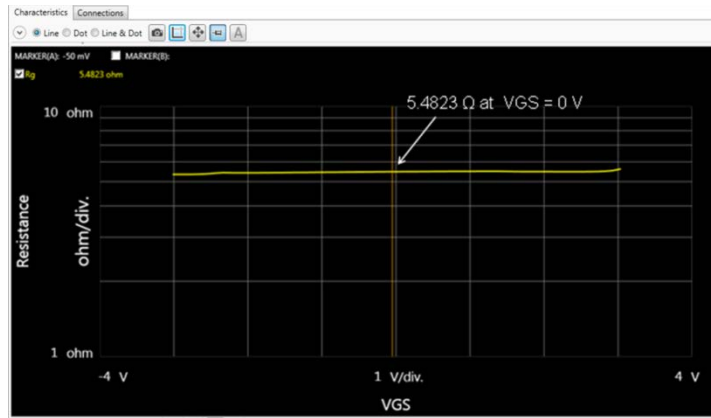

Figure 4-14 Rg measurement result.



Tips: Rg measurement of MOSFET

For power MOSFET, typically Rg is measured as a series resistance when measuring Cgs with drain open condition as shown in Figure 2-55(a).

Figure 4-15 Rg measurement for power MOSFET

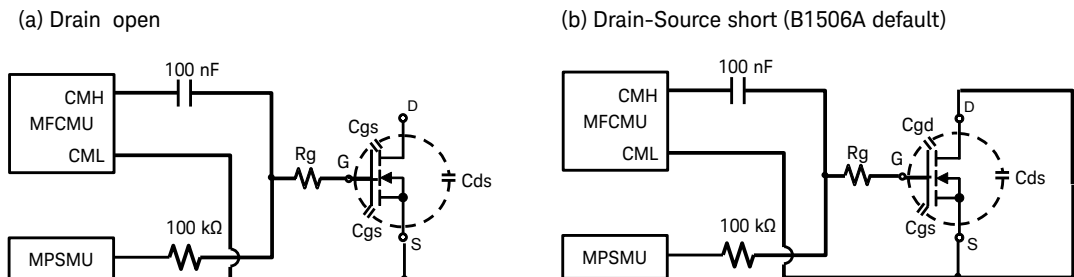

Note: The default setup of the Easy Test Navigator software for the Rg measurement template for MOSFET is the short connection of the drain and the source as shown in Figure 2-55(b). The connection of the drain and the source short is used to minimize the error associated by the "Device capacitance switch". Therefore, it is recommended to use the default drain-source short condition unless there is some particular reason.

To open the drain and source connection, refer to "**Rg measurement with the open or voltage biased drain/collector**" in the section headed "**Useful information for using capacitance measurement**" at the end of this chapter.

Tips: An Rg measurement of IGBT

In the case of IGBT, use the same condition as in the Cies measurement with the specified collector voltage (Figure 4-16).

Figure 4-16 An Rg measurement circuit for IGBT with voltage biased collector

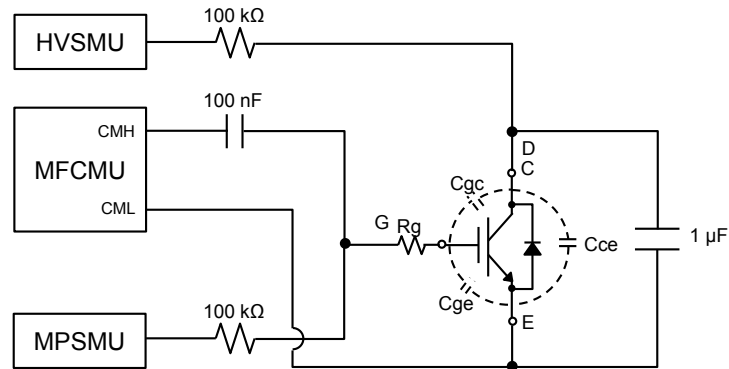

Note: The default setup of the Easy Test Navigator software for the Rg measurement template for IGBT is the same as for Cox measurement, and cannot apply a bias voltage to the collector.

Tips: How to apply the bias voltage to the collector in the Rg measurement
To apply a bias voltage as shown in Figure 2-56, refer to "**Rg measurement with the open or voltage biased drain/collector**" in the section headed "**Useful information for using capacitance measurement**" at the end of this chapter.

3. IGBT module measurement example and tips

IGBT module connection

The connection to measure an IGBT module is the same as it is in IV measurement.

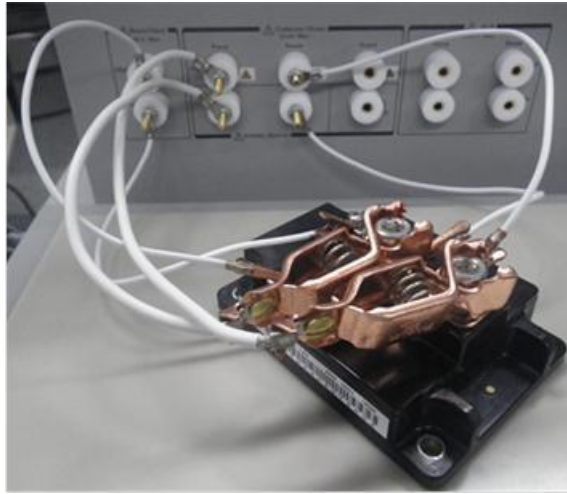

Tips:

Calibration

Since additional test leads are used to connect the device to the B1506A output, it is necessary to do open and short compensation at 1 MHz.

IGBT / MOSFET module (multi-chip module)

To measure the capacitance of a multi-chip module, typically, the capacitance of an individual device is measured.

For example, in the case of a half bridge type of 2-in-1 IGBT module, the capacitance of the high side device and the low side device has to be measured separately.

To measure the capacitance of the high side device, the outputs of the B1506A's test fixture are connected as shown in Figure 4-17.

The gate and emitter of the low side device are connected by a shorting bar/ring. Also, the emitter of the low side device is kept open.

To measure the capacitance of the low side device, the output of the N1265A is connected to the low side device, and the gate and emitter of the high side device have to be shorted as shown in Figure 4-18.

Figure 4-17 The connection to measure the capacitance of the high side device.

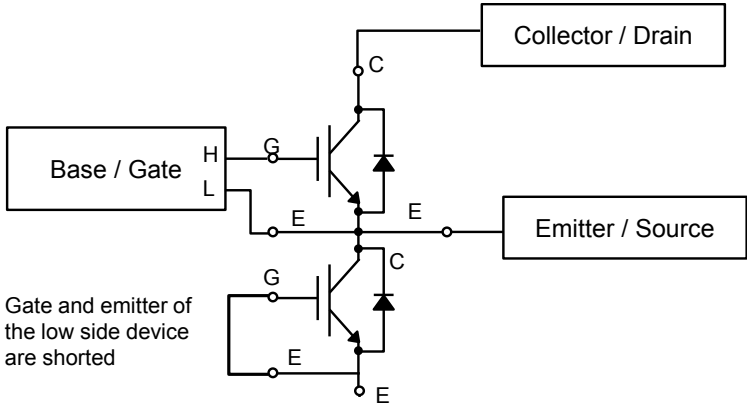
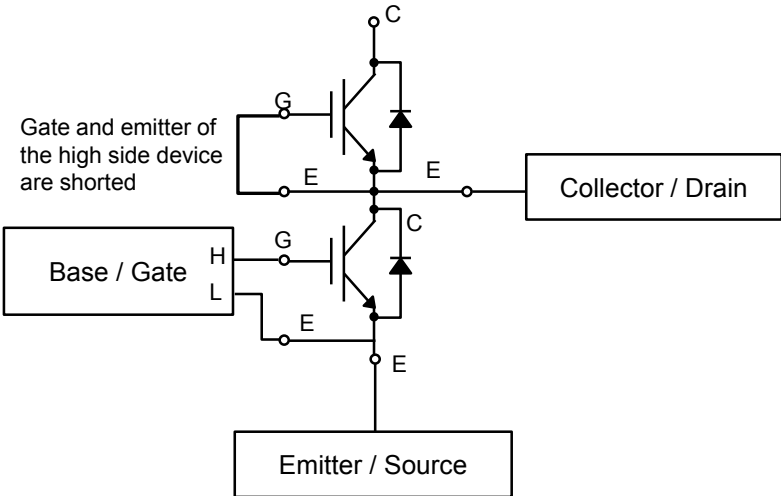

Figure 4-18 The connection to measure the capacitance of the low side device.



Useful information for using capacitance measurement mode

Crss measurement of super junction FET

Measuring Crss of the devices which Crss is very small compared to Cds, such as super junction FET, is not easy. This section explains a commonly seen problem, the reason and the solution in the Crss measurement.

Commonly seen problem in Crss measurement

Figure 4-19 shows a Crss measurement example using 1 MHz frequency.

It measures three parameters as Ciss, Coss and Crss as shown in the figure. There are Ciss and Coss plots, but no Crss line is drawn. The Crss marker reading, that is shown in the enlarged copy enclosed by a red dash line, shows "NaN F" which indicates the measurement is not successfully made.

Figure 4-19 Crss measurement example at 1 MHz (super junction FET).

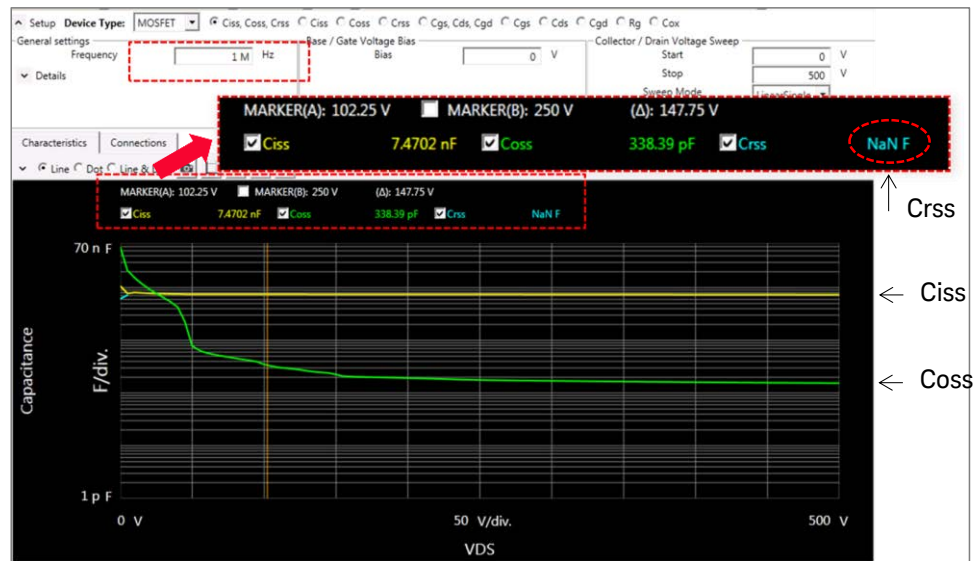

If the Y axis is changed to linear scale as shown in Figure 4-20, Crss is shown in negative capacitance value.

Figure 4-20 Crss measurement example (linear Capacitance scale) at 1 MHz (super junction FET).



100 kHz solves the negative Crss measurement problem

The Crss measurement error increases sharply when the measurement frequency increases as shown in the "Measurement frequency" section. The theoretical reason is explained.

Figure 4-21 shows a simplified Crss measurement error model of the B1506A.

Consider the case where C_{ds} is 10 times larger than C_{gd} . Then, a 10 times larger current is flowing through C_{ds} compared to C_{gd} . There is also a leakage current i_{gs} from the source to the gate through the C_{gs} component, because there appears a small leakage voltage generated by the i_{ds} and the AC guard impedance ($=2\pi fL$). If to make the i_{gs} leakage current through C_{gs} smaller than 1/100 of the current through C_{gd} (it is 1 % error), separation ratio of $Z(\text{Ac guard}) / Z(C_{gs})$ must be smaller than $1/100$ (% error) * C_{dg}/C_{ds} ($=1/100 \times 1/10 = 1/1000$).

For example, if C_{gs} is 2 nF, the impedance of C_{gs} ($Z(C_{gs})$) at 1 MHz is about 79 Ω . The impedance of AC guard ($=1/1000 \times Z(C_{gs})$) must be less than 79 m Ω , and it is equivalent to 13 nH.

Since the residual inductance can be considered as the equivalent cable length from the instrument AC guard terminal to the source terminal of the device including the connection cable, and 13 nH is just 1 cm to 2 cm cable length.

Therefore, it is impossible to realize such a low impedance AC guard at 1 MHz. But if the measurement frequency is lowered by ten times to 100

Capacitance Measurement

kHz, a 100 times longer cable length is allowed, and it falls inside the realistic condition.

Further lowering frequency proportionally improves the measurement error, in this case.

Figure 4-22 shows such an example of the C_{rss} measurement at 100 kHz measurement frequency of a super junction FET, where the C_{ds} is about 30 to 50 times larger than C_{rss} . (Note that C_{oss} is almost the same as C_{ds} in this case.)

Figure 4-21 Simplified C_{rss} (=Cgd) error model

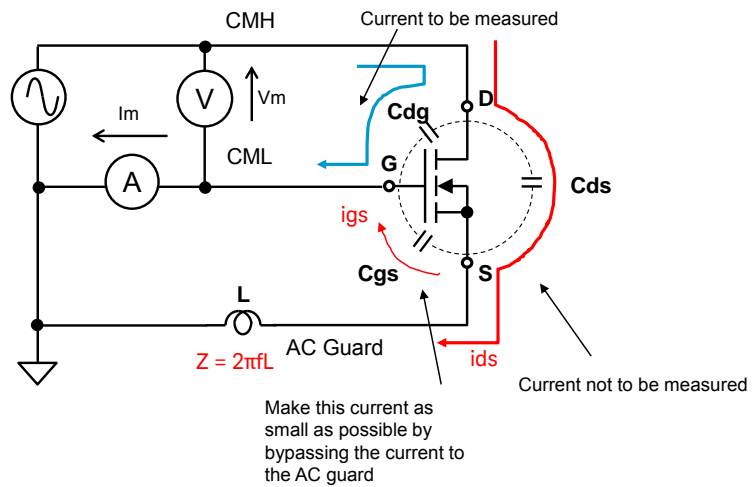
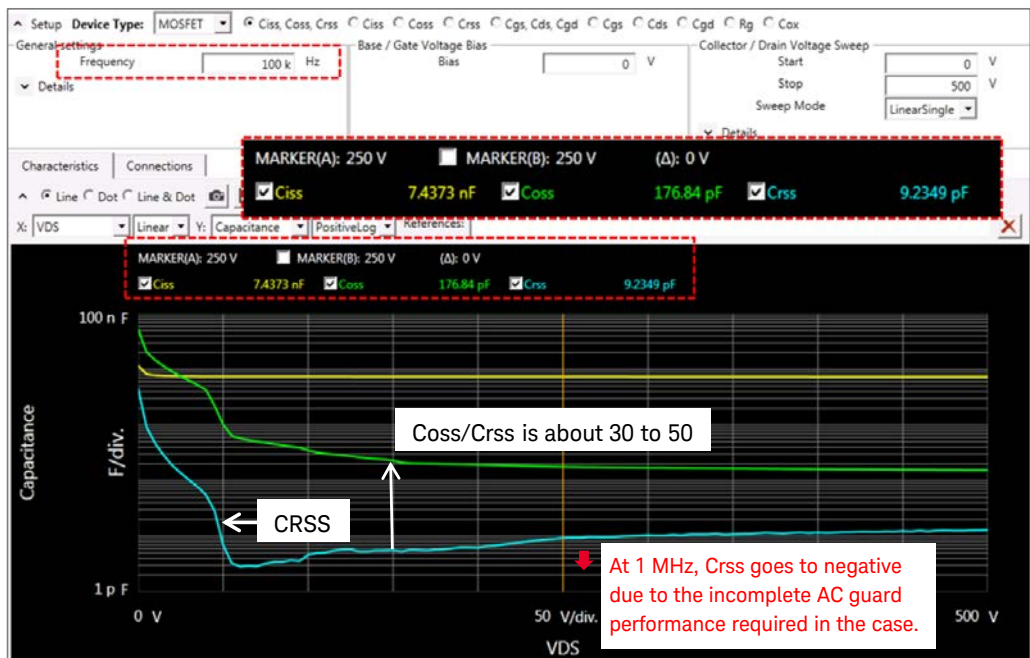

Figure 4-22 C_{rss} measurement example at 100 kHz (super junction FET).



Capacitance compensation data measurement

This section describes how to perform capacitance compensation data measurement.

How to measure capacitance compensation data:

Follow the next steps to measure the capacitance compensation data.

- ✓ Open the "Capacitance Measurement" mode template.
- ✓ Click the "Start Calibration..." button.

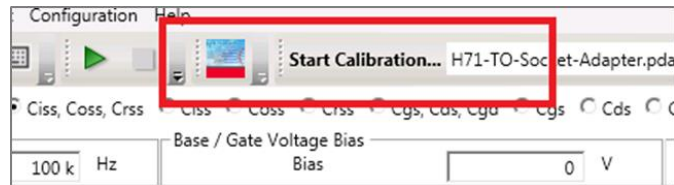

Device Capacitance Selector Calibration panel as shown in Figure 4-23 opens.

- ✓ Choose "Full Path Calibration Measurement" or "Minimum Path Calibration Measurement".
 - Full path calibration measures the entire connection path of the capacitance measurement combination.
 - Minimum path calibration measures only the path of the selected measurement parameters.

Note: For initial setup, "Full Path Calibration Measurement" is recommended, but it takes about 20 minutes.

Figure 4-23 Device Capacitance selector calibration panel.

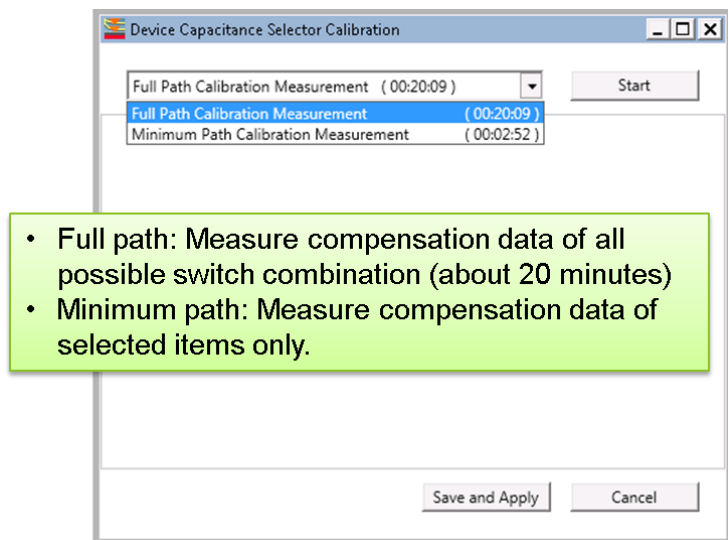

- ✓ Open compensation: (Refer to Figure 4-24)
 - a. The window to confirm the connection to measure "open compensation data" opens.
 - b. Attach the socket module (Figure 4-25(b1)) or test leads without the device (Figure 4-25(b2)).
 - c. Make sure the device is removed.
 - d. Click the "OK" button to start measurement.
 - e. During the measurement, progress of total measurement and connection diagram currently measured are displayed.

Figure 4-24 Open compensation GUI.

Confirmation of Connection for open compensation

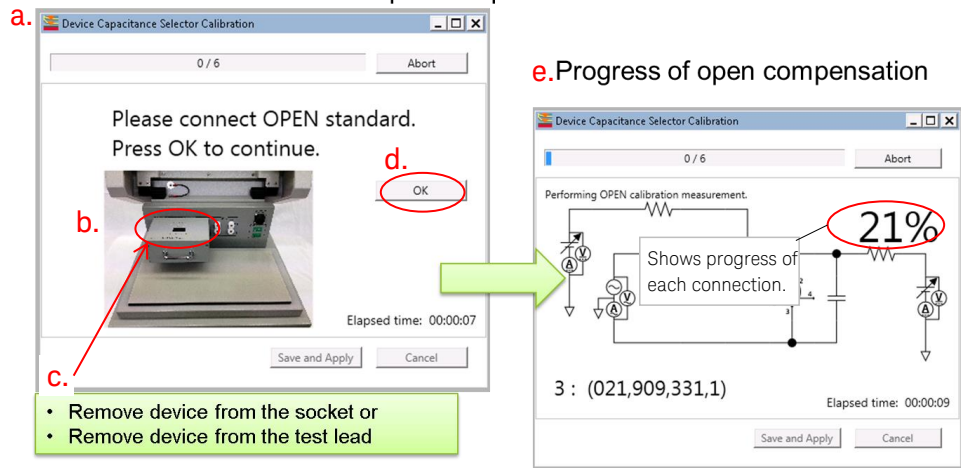
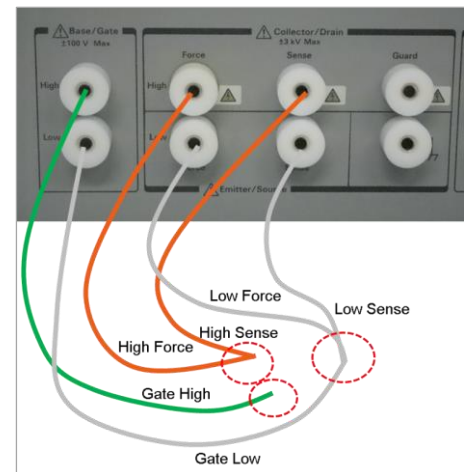

Figure 4-25 Connection example for open compensation.

(b1.) Socket module (open)



(b2.) Test leads connection (open)



- ✓ Short compensation: (Refer to Figure 4-26)
 - a. After completing the open compensation measurement, a pop-up window to confirm the connection to measure short compensation data opens.
 - b. Insert a shorting device into the socket (Figure 4-27(b1)) or connect the ends of all cables (Figure 4-27(b2)).
 - c. Click “OK” to start measurement.
 - d. During the measurement, progress of total measurement and connection diagram currently measured are displayed.

Figure 4-26 Short compensation GUI.

Confirmation of Connection for short compensation

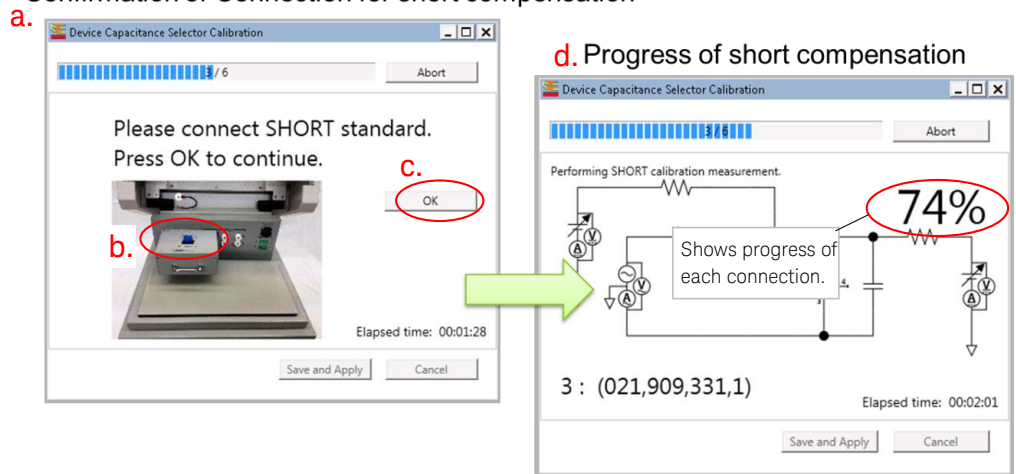
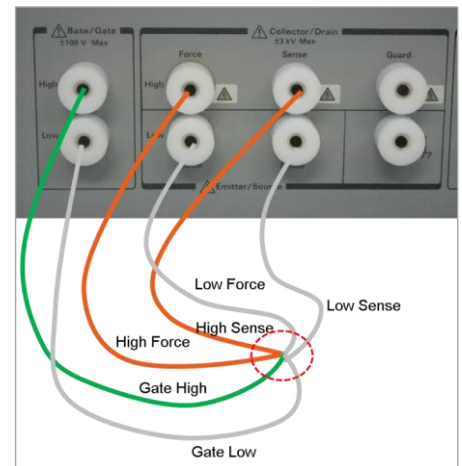

Figure 4-27 Connection example for short compensation.

(b1.) Socket module (open)



(b2.) Test leads connection (open)



- ✓ Save and apply the compensation data: (Refer to Figure 4-28)
 - a. After completing the short compensation measurement, click “OK”.
 - b. Click the “Save and Apply” button to make the measured compensation effective.
 - c. Save the compensation data under an arbitrary name.
 - d. Effective compensation data file is displayed in the ribbon menu.

Figure 4-28 Saving and recalling the compensation data.

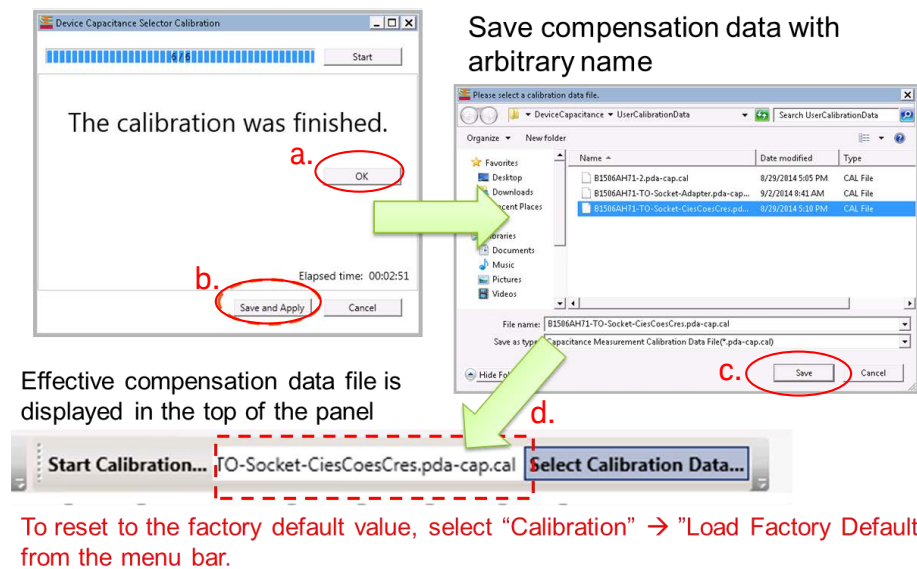

Tips:

How to use existing compensation data

- ✓ It is possible to switch the compensation data by loading the compensation data file measured for each adapter or connection.
- ✓ The saved data appears in the menu ribbon of the Capacitance Measurement mode panel. (Refer to fig4-xx6(d).)

Tips:

How to reset to "Factory Default" setting

- ✓ To reset the compensation data to the factory default value, select “Calibration” --> “Load Factory Default”

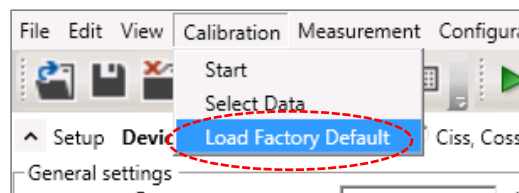

Rg measurement with the open or voltage biased drain/collector

This section provides the information to realize the open or voltage biased drain/collector required for Rg measurement.

How to change the condition for Rg measurement manually:

Figure 4-29 shows the Rg measurement preset setup panel. The important setup parameters are explained in the following steps. Refer to the corresponding number shown in the figure.

1. Click Rg parameter measurement.
2. Measurement frequency can be change.
For Crss measurement, 100 kHz measurement frequency typically provides better measurement accuracy.
3. The gate voltage can be set in this part.
4. In the default Rg measurement setup, Collector/Drain voltage cannot be applied.

Figure 4-29 Rg measurement setup detail.

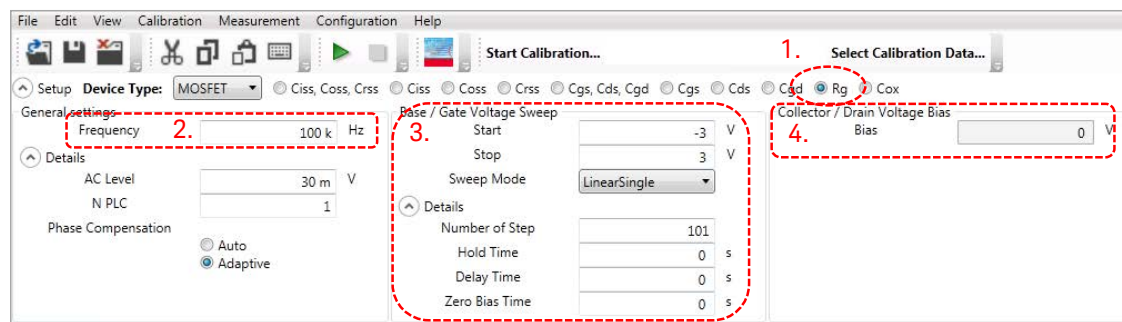

The following section provides details of how to apply a bias voltage or set to open condition.

How to change the connections:

5. Click "Connections" tab.
The simplified block diagram of the current connection is shown.
6. Check "Details"
7. Click the down arrow to open the connection setup panel under the connection block diagram as shown in Figure 4-31.

Figure 4-30 Opening the detailed setup of the capacitance measurement.

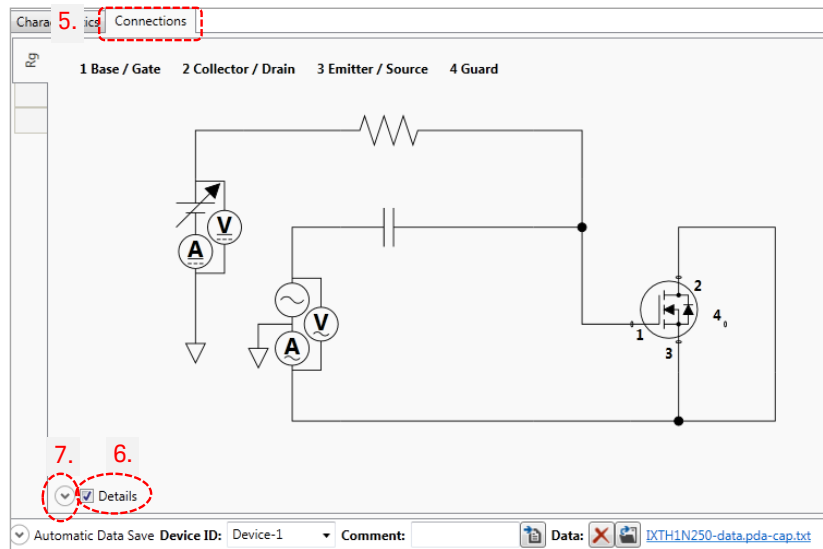
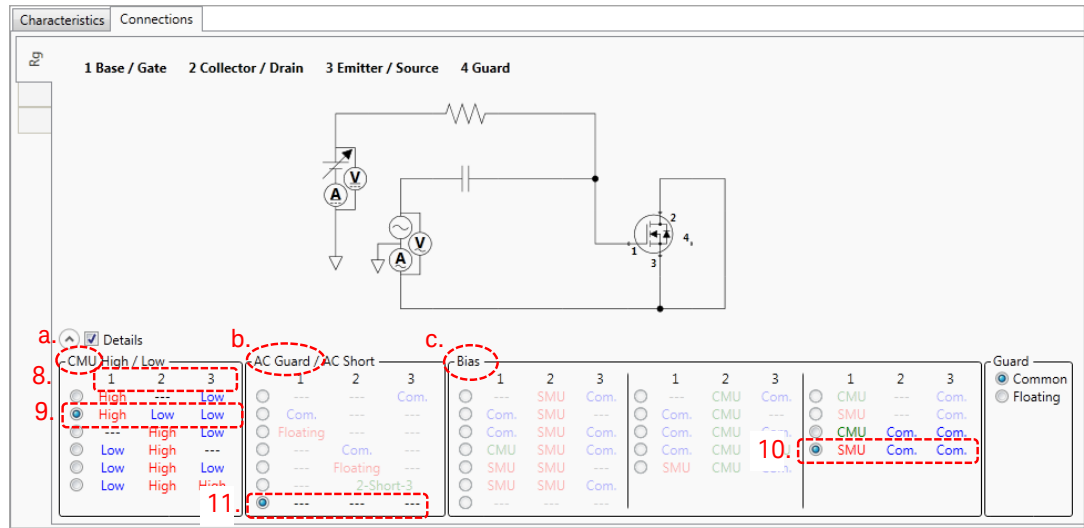

Figure 4-31 shows a default connection setup of Rg measurement for MOSFET.

- a. This block sets the CMU connection.
- b. This section sets the AC guard connection.
- c. This section defines what bias voltages are to be applied to each device terminals.
8. The 1, 2 and 3 numbers in this line for each column indicate the corresponding pin numbers of the device terminal shown in the same figure.
9. This indicates that the CMU High terminal is connected to the gate, and the drain and source are both connected to the CMU Low terminal.
10. This block indicates that the gate terminal bias voltage is applied from the SMU, and the bias voltage of the other device terminals are set to common level.
11. The AC guard is not connected to any device terminal.

Figure 4-31 The default Rg measurement setup detail for MOSFET.



To open the drain/Collector terminal: (Refer to the next steps)

12. Change the CMU connection as shown in the figure. The short connection between the drain and source is disconnected.
13. The gate bias voltage is applied from the SMU.

Figure 4-32 Making the collector/drain terminal open for Rg measurement.

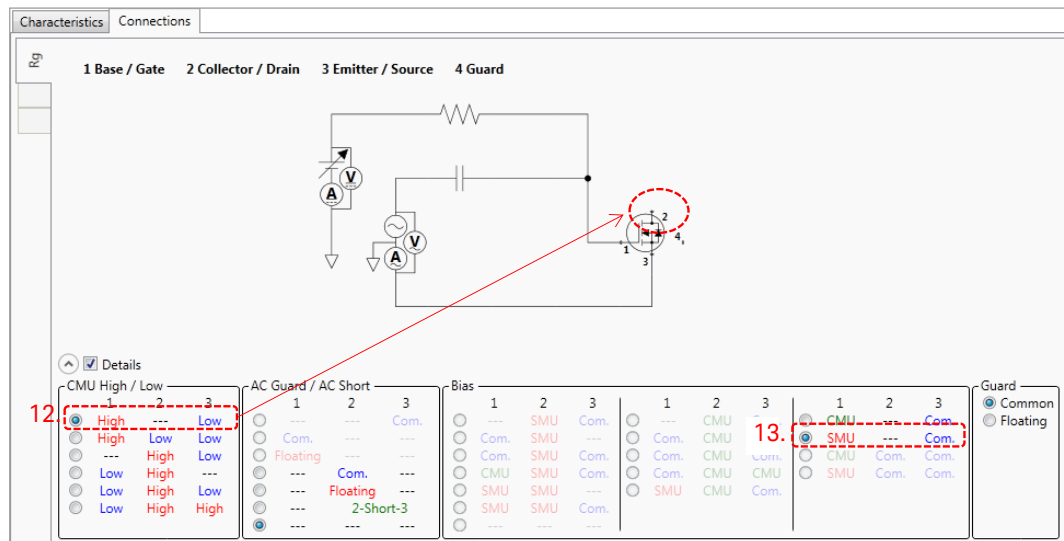

To apply a bias voltage to the drain/collector terminal: (Refer to Figure 4-33 from the next steps.)

14. Click the "AC Short" setting to short pin 2 and pin 3.
The connection block diagram is changed to short the drain and the source by a capacitor in AC measurement frequency. This change also renews the available bias setting in the "Bias" setting block.
15. Click the "SMU SMU Com" setting. This setting provides bias voltage both to the gate and the drain/source from SMUs as shown in the figure.

Figure 4-33 Setting to apply a bias voltage to the collector/drain terminal in the Rg measurement

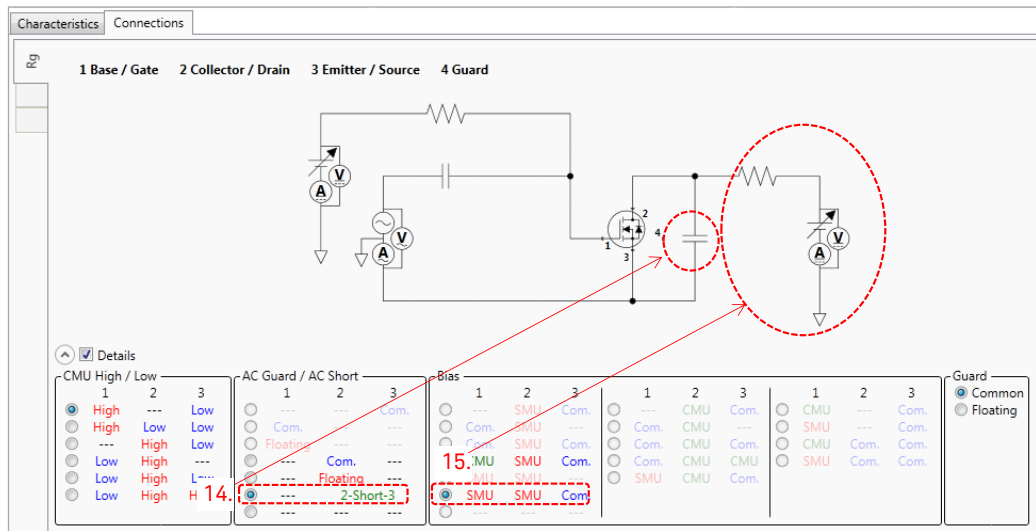

V_{gs} accuracy improvement by self calibration

The V_{gs} is applied through the 100 kΩ resistor, and the voltage drop by this resistor is compensated using the current measured by the MPSMU, which is connected to the other end of the 100 kΩ resistor.

Because, there is some offset current in the MPSMU, and the voltage drop by this offset current and the 100 kΩ resistor is not negligible.

By performing the self calibration, the error caused by the MPSMU's offset current can be removed.

How to perform the self calibration:

Follow the next steps by following the corresponding numbers shown in fig.

1. Click "Configuration".
2. Module Configuration panel opens.
3. Click "Self Calibration".
The calibrations for MPSMUs are made.
4. After finishing the calibration, click "Close".

Figure 4-34 Self calibration of MCSMUs.

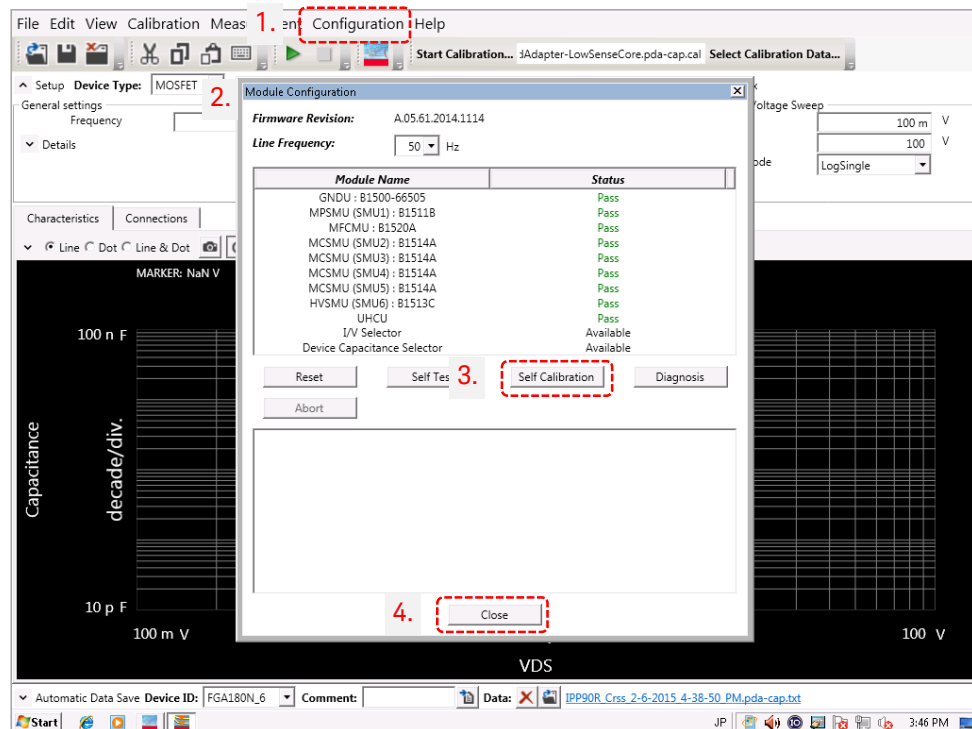

Capacitance Measurement

5. Gate Charge Measurement

Overview	262
Measurement preparation	264
How to open the gate charge measurement mode.....	264
Gate charge measurement adapter	264
Using B1506A-F14 Qg measurement adapter	265
Gate charge measurement examples.....	267
1. Qg Measurement Using Constant Current Load	267
1-1. IGBT: FGA180N33ATD Qg measurement.....	267
1-2. Changing measurement conditions	273
1-3. Measureing a super junction MOSFET	277
1-4. SiC MOSFET measurement	280
1-5. VGS swing from negative to positive bias.....	281
2. Qg measurement using a resistive load	283
An IGBT module (single) measurement example	283
Useful information for using Qg measurement mode.....	292
Calibration for gate charge measurement.....	292
To start calibration:	292
TO-package device calibration	294
Module device calibration	297
Brief idea of the gate charge measurement setup	300

Overview

The definition of the gate charge (Q_g) is a charge to drive a gate terminal of a switching device from the off-gate voltage to the on-gate voltage under a specific device operating condition. Figure 5-1 shows a typical waveform of the gate voltage (V_g or V_{GS}), the drain voltage (V_{DS}) and the drain current (I_D) when constant gate current I_g is injected into the gate terminal.

Figure 5-1 Basic gate charge measurement diagram and the waveform.

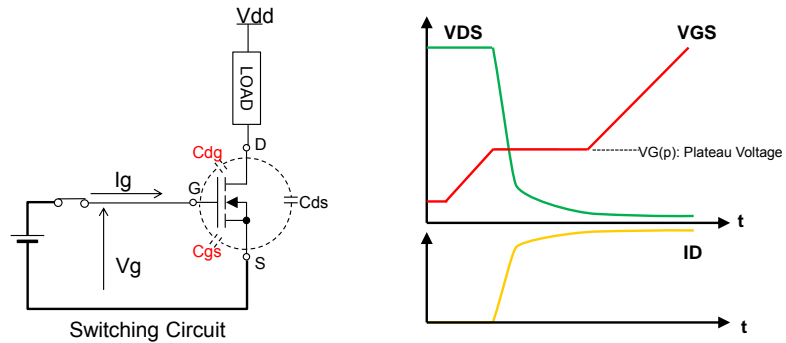

Due to a mirror effect through the C_{dg} capacitance, V_{GS} curve shows a flat part in the middle of the sweep where the drain voltage is slewing from off to on state. The gate voltage in the flat part is a so called gate plateau voltage. V_g - Q_g curve is used as the gate charge characteristics in the device datasheet.

V_g - Q_g curve consists of mainly three parts. Figure 5-2 shows a definition of the V_g - Q_g curve based on the JEDEC standard (JESD 24-2).

Figure 5-2 Q_g parameter definition of JEDEC standard 24-2.

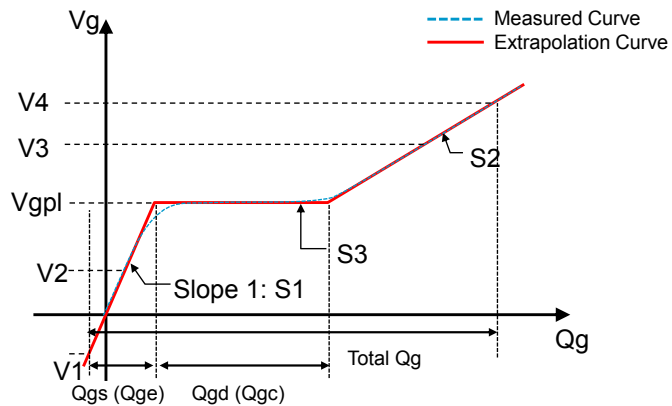

- S1: Determined by the C_{gs} at the off-state
 - S2: Determined by the C_{iss} at the on-state
 - S3: Determined by the mirror capacitance (C_{gd}) during a transient from the off-state to the on-state.
- V_{gpl} : Plateau gate voltage. Gate voltage to make drain current at the specified value. Higher $I_d \rightarrow$ Higher V_{gpl}

Figure 5-3 shows an example of a gate charge measurement setup template. There are several test setup panels behind this GUI. Refer to "Brief idea of the gate charge measurement setup" in the section headed "Useful information for using Qg measurement" at the end of this chapter for more details of the setup.

Figure 5-3 An example of a gate charge measurement template.

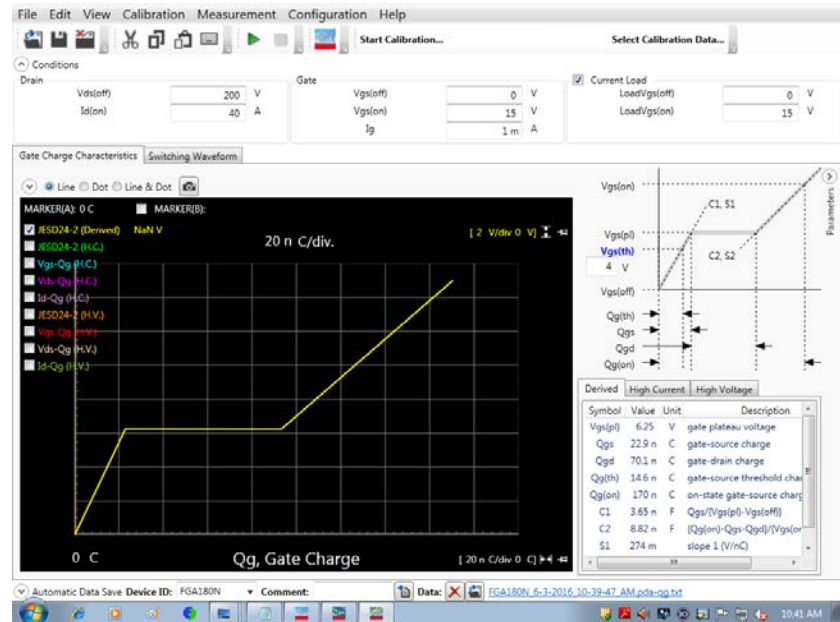

Measurement preparation

This section provides the information to prepare the gate charge measurement.

How to open the gate charge measurement mode

The gate charge measurement mode is started from the Easy Test Navigator as shown in Figure 5-4.

- ✓ Click on “Gate Charge Measurement” to start the template.
- ✓ The gate charge measurement template shown in Figure 5-3 opens.

Figure 5-4

Gate Charge Measurement mode startup from the Easy Test Navigator.

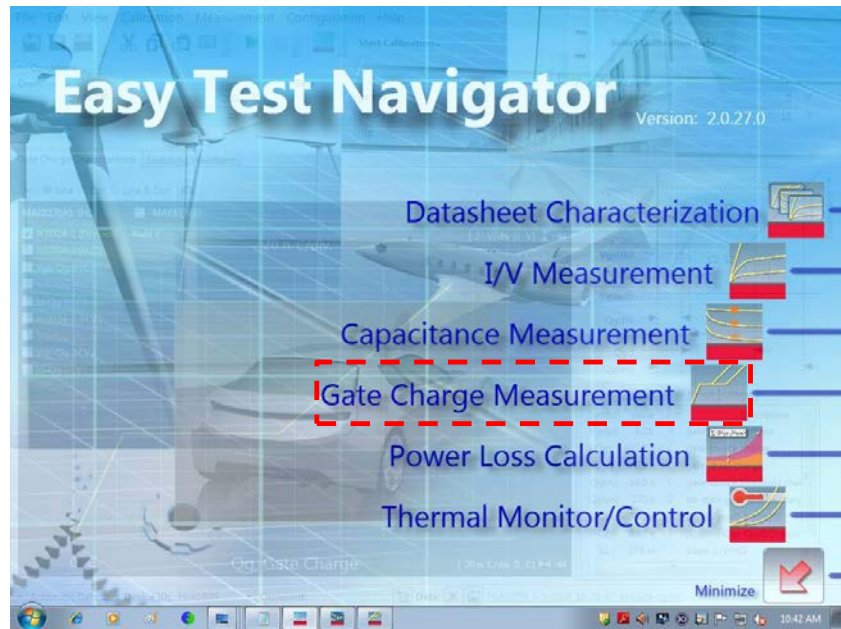

Gate charge measurement adapter

To measure the gate charge, the B1506A-F14 Qg measurement adapter is used. It supports both the constant current load method and the resistive load method. Also, it has a switch to measure Qg of module type of device like IGBT modules in addition to the standard 3-pin inline packaged device.

Using B1506A-F14 Qg measurement adapter

Using the Qg adapter shown in Figure 5-5, TO-220 packaged device can be measured directly.

1. How to set Qg adapter to B1506A:

Figure 5-6 shows how to attach the Qg measurement adapter to the output of the B1506A test fixture.

- ✓ Set the Qg adapter by aligning the test pin to the far left side of the B1506A test fixture.

Figure 5-5 Gate charge measurement adapter.

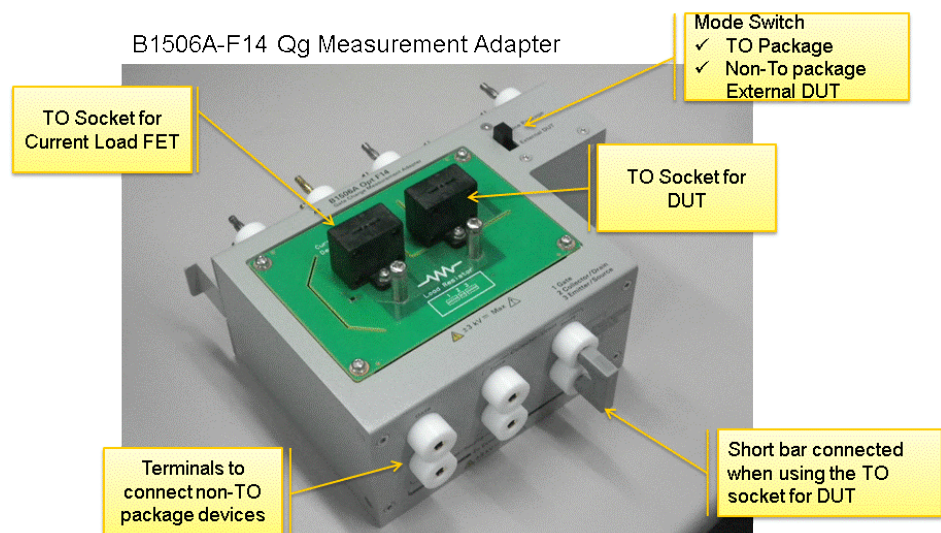

Figure 5-6 Attaching the Qg adapter to B1506A test fixture.



2. How to set constant current source FET/IGBT:

Figure 5-7 shows the current load FET/IGBT setup to the Qg adapter.

- ✓ Put the power MOSFET or IGBT used as a constant current source to the socket located in the left of the adapter.
- ✓ Confirm that the switch is at “Internal Package” and a shoring bar is attached to the collector sense terminal at the surface of the adapter.

Figure 5-7

The constant current load FET/IGBT in the left socket, and confirming switch position and the short bar

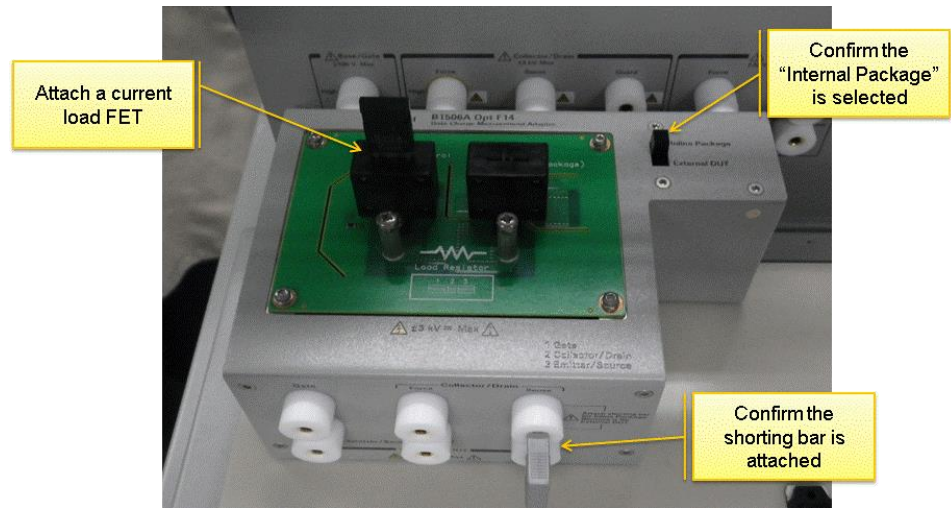

Note:

How to choose a constant current load FET/IGBT

Refer to “Gate charge measurement” in the last part of chapter “Datasheet Characterization”.

Gate charge measurement examples

The following example measurements are shown as the demonstration of the gate charge Measurement mode.

1. Qg measurement using the constant current load
2. Qg measurement using the resistive load

1. Qg Measurement Using Constant Current Load

1-1. IGBT: FGA180N33ATD Qg measurement

In this example, IGBT FGA180N33ATD is used as the example test device.

This device has the following basic characteristics.

- ✓ DUT: FGA180N33ATD
- ✓ VCES: 330V
- ✓ IC: max 180 A (DC)
- ✓ QG @ Vce=200 V, Ic=40 A, Vge=15 V
 - Qg: 169 nC typ.
 - Qge: 22 nC typ.
 - Qgc: 69 nC typ.
- ✓ Set the test device to the right socket in the test fixture as shown in Figure 5-8.



FGA180N33ATD
IGBT

Figure 5-8

FGA180N33ATD set in the Qg adapter.

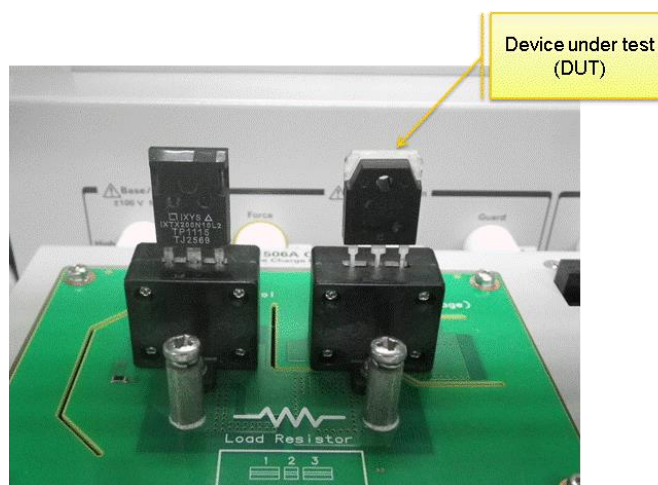

- ✓ Open Qg measurement mode
Input measurement parameters based on the Qg characteristics described in the datasheet.
Follow the next numbers by referring to the corresponding number shown in Figure 5-9.

Note: Parameter name mapping of Gate Charge Measurement

The device parameter name in the Charge Measurement mode template is designed for MOSFET. For IGBT, use the following conversion in the parameter name.

1. Vds(off) = Vce(off) : 200 V
2. Id(on) = Ic(on) : 40 A
3. Vgs(off) = Vge(off) : 0 V
4. Vgs(on) = Vge(on) : 15 V
5. Input the Vth from the VGE(th) (VGS(th) for MOSFET) to the Vgs(th) in the definition area of the Qg curve.
6. Gate current (I_g) is not usually picked up from the datasheet. The I_g parameter used in the B1506A is determined by the following steps.

I_g determination:

Calculate the required charges (R_q) to drive the gate using the following formula:

$$R_q = (Q_g \text{ (from the datasheet)} / V_{GE} \text{ (Test condition)}) + 1.6 \text{ nF} \times ((V_{GE} \text{ (Test condition)} + 3.5) \times (1.5 \sim 2))$$

Using the example parameters, R_q can be calculated as;

$$\begin{aligned} R_q &= (169 \text{ nC} / 15 \text{ V}) + 1.6 \text{ (nF)} \times (15 \text{ V} + 3.5) \times (1.5 \sim 2)^* \\ &= 238 \times (1.5 \sim 2) \text{ nC} \\ &= 357 \sim 476 \text{ nC.} \end{aligned}$$

Note: This charge must be forced to the gate within one gate pulse width period from the MCSMU.
*: x (1.5 ~ 2) factor is multiplied to compensate the actual current from MCSMU. The MCSMU current in a short transient period is typically lower than the set value, and adding this factor is recommended.

- a) Minimum I_g calculation:
Calculate the minimum I_g required to charge R_q in default 400 μs "OnPeriod" of the pulse.
 - Min. I_g = R_q / 400 μs
 Using the required charge obtained in the previous step, minimum I_g setting is calculated as,
 - Min. I_g = (357 ~ 476) nC / 400 μs = 0.89 mA ~ 1.19 mA

- b) Determination of I_g :
 Using the I_g obtained in the previous step, 1 mA (which is closer to the full scale of the MCSMU's current range) is used in the example Q_g measurement.

Note that, I_g can be forced closer to the set value when I_g is set closer to the full scale of the MCSMU's current range. The MCSMU's current ranges are 10 μ A, 100 μ A, 1 mA, 10 mA, 100 mA and 1A.

Note: Drain pulse width setting

The drain pulse width is set in the "Switching Waveform" tab -> "High current" panel as shown in Figure 5-10. The maximum drain pulse width is limited by the following parameters:

- Q_g measurement ON current
- UHCU's output voltage
- SOA of the current load FET/IGBT

Figure 5-9 Measurement parameter setup for Q_g Measurement for FDGA180N33ATD.

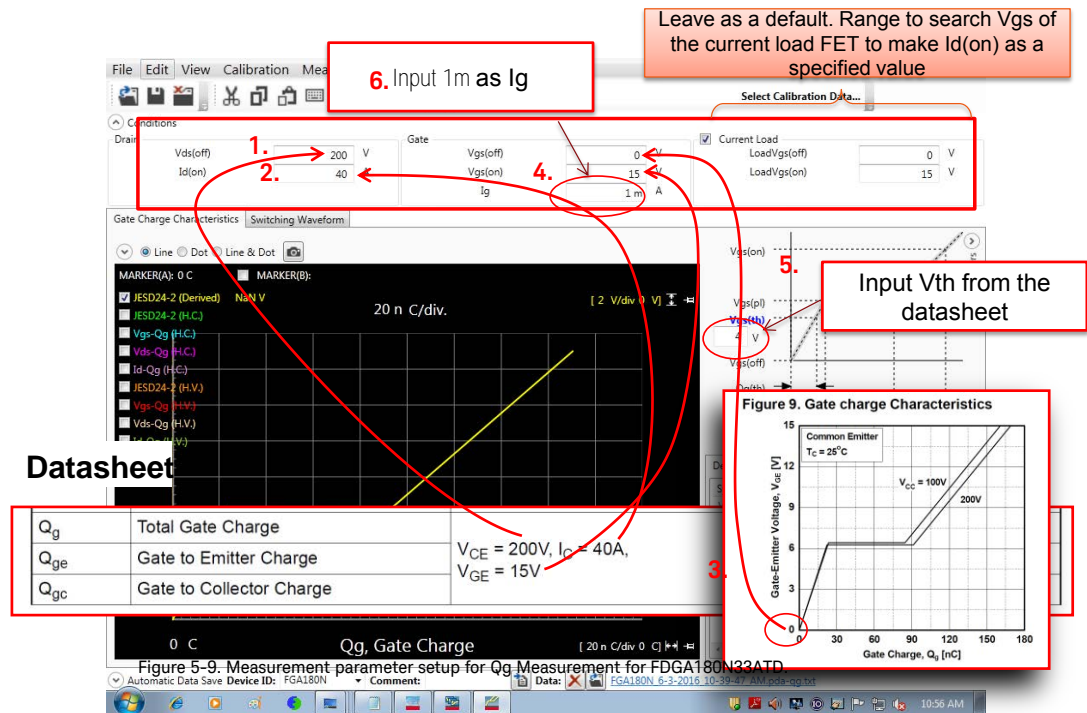
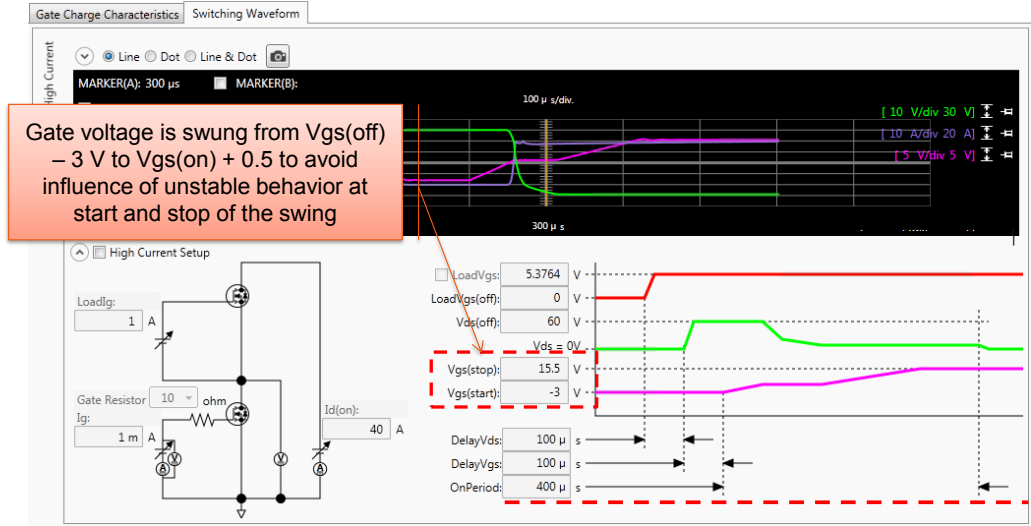

Figure 5-10 Qg measurement pulse width setup pane for UHCU.



Qg is measured during this On period

Max. 1 ms – DelayVgs (500 μs – Delay Vgs for more than 500 A)

- After determining the gate current, click the measure button, and the Qg curve is displayed. (Refer to Figure 5-11.)
- JEDEC 24-2 based Qg parameters are extracted automatically.

Figure 5-11 Qg measurement and the results.

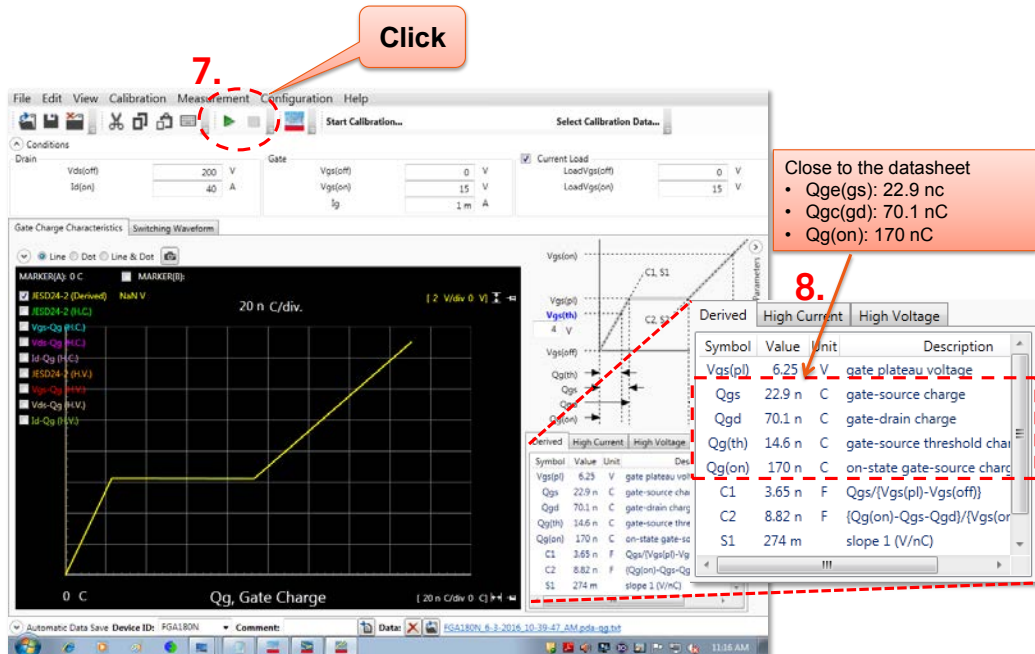

Tips: How to check for unknown devices

If the Qg of the device is unknown, it is possible to check if the gate current is appropriate or not by using the dotted display mode.

How to display in dotted display mode:

First, display the measured Qg curve measured by high current units and HVSMU by checking the "Vgs-Qg(H.C)" and "Vgs-Qg (H.V.)". Then, change the display mode to "dot". (Refer to Figure 5-12.)

- ✓ If the separation of each measurement point is small enough (curve looks dense), the used Ig is small enough.
- ✓ If the curve is coarse, the used Ig is too large and it is necessary to use a lower Ig to measure the device.
- ✓ If the Ig is too small, the gate voltage does not reach the VGS(on), and an error pops up to indicate that the used Ig is not large enough as show in Figure 5-13.

When looking at the waveform, the measured Vgs does not reach the specified Vgs with this setting.

Figure 5-12 A dotted mode display of the Qg curve.

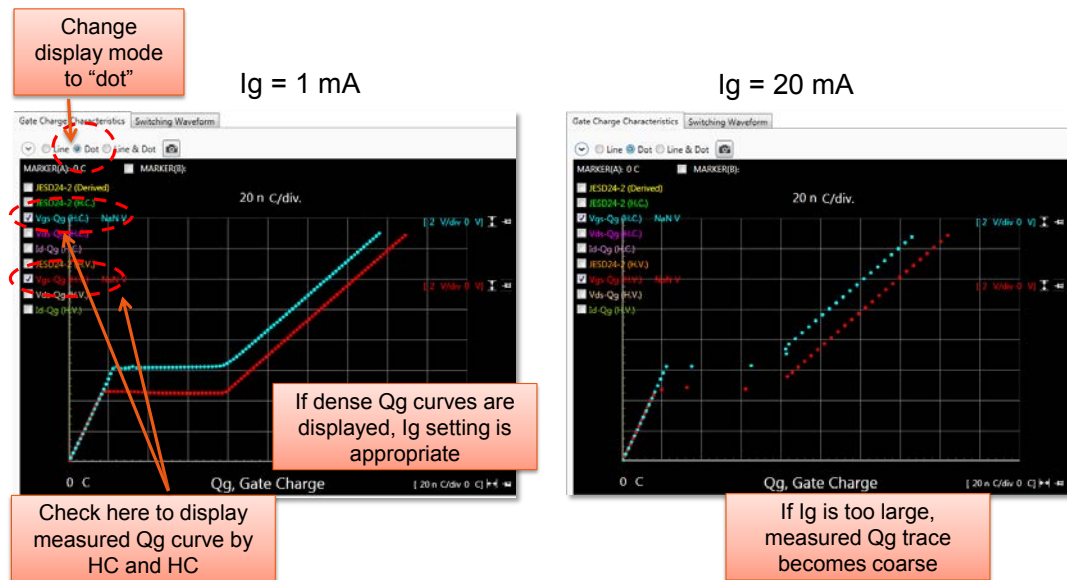

Gate Charge Measurement

Figure 5-13 An error when the I_g is too small

(a) An error message and switching waveform when the I_g is too small

$I_g = 400 \mu\text{A}$

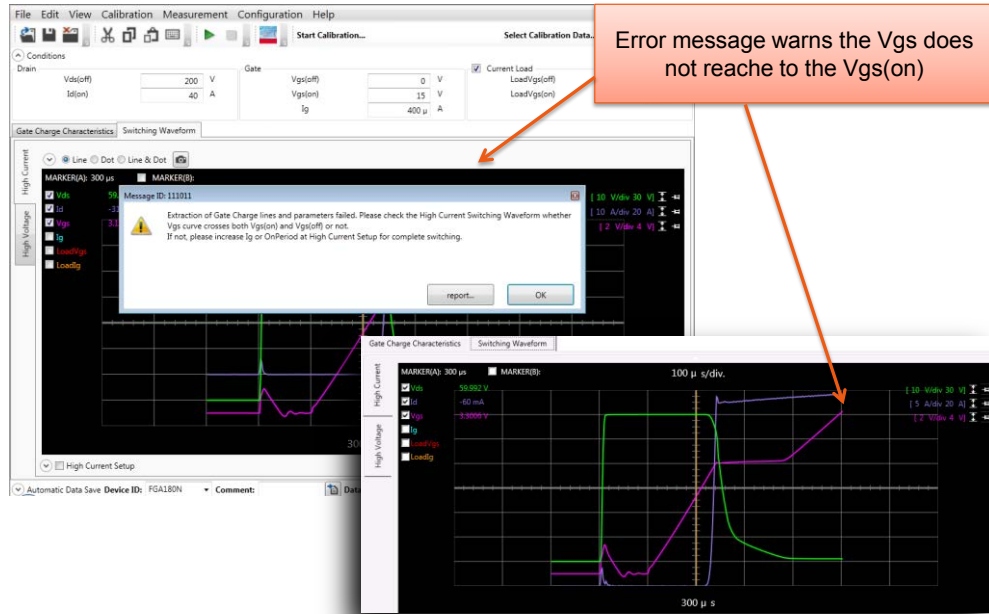

(b) Error message details

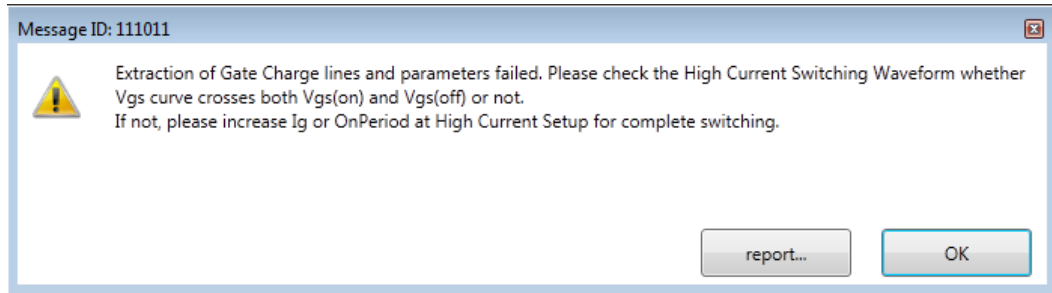

1-2. Changing measurement conditions

In the existing Q_g measurement solution, it is necessary to change the load resistance, if Q_g is measured with a different on-current.

In B1506A, it is possible to measure in a different drain current by just changing the input parameter in the Q_g measurement panel.

This section introduces how easily the on current can be changed.

To change the on current

Follow the next steps by referring to the corresponding number shown in Figure 5-14.

1. Click the camera icon to capture the current trace as a reference.
2. Change $I_d(\text{on})$ to 100 A from 40 A.
3. Click the measure button, and the newly measured Q_g curve with 100 A on-current is overlaid to the 40 A Q_g curve as shown in Figure 5-15.

Figure 5-14

I_d change from 40 A to 100 A.

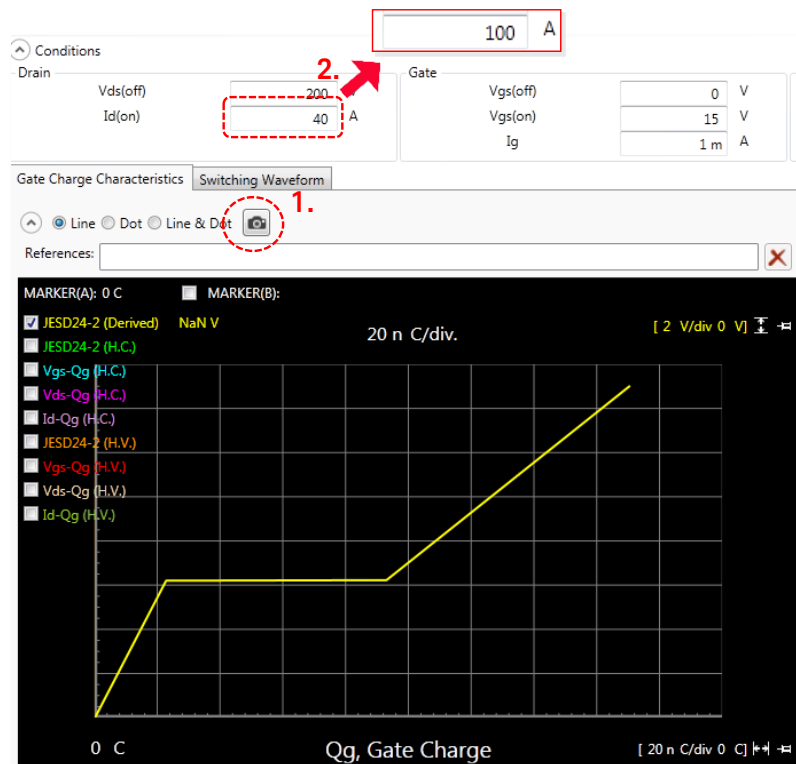
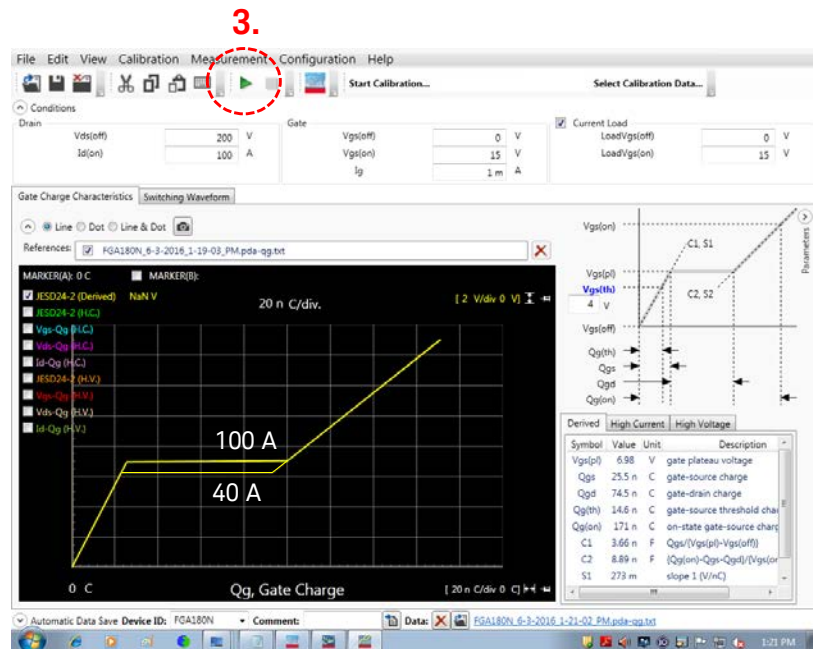

Figure 5-15 Qg curve at Id=100 A is overlaid on the Id=40 A Qg curve.



Tips:

Current load FET's current adjustment

The gate voltage to drive the current load FET is automatically adjusted prior to measuring the Qg curve.

Figure 5-16 shows a detailed measurement settings during the Qg measurement.

Note:

To check the detailed setup,

1. Select the "Switching Waveform" tab,
2. Select the "High Current" tab,
3. Click the down arrow button.

The gate voltage of the current load FET, in the example, is about 5.38 V for 40 A measurement, and 6.0 V for 100 A.

Figure 5-16 To monitor the setting of the current load FET.

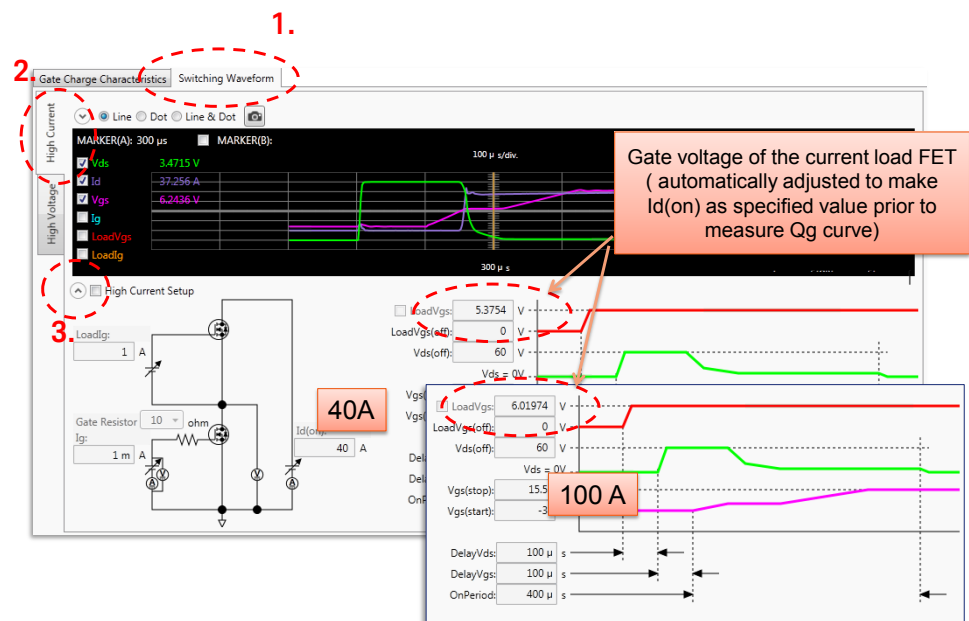

To change the off voltage

To change the $V_{ds}(\text{off})$, it is also necessary to change the load resistance to keep the same on-current in the existing solution.

But, in B1506A, it is possible to change the off-state voltage by changing the $V_{ds}(\text{off})$ in the input parameter as shown in Figure 5-17.

Tips:

Voltage source change is made automatically

In the B1506A, the voltage source is switched automatically by the measurement condition.

If the off-state voltage is larger than the maximum voltage of the high current units (HCSMU or UHCU), the HVSMU is used to measure the Q_g curve at the specified $V_{ds}(\text{off})$.

In this measurement, the on-current is just determined as the maximum current of the HVSMU (HVSMU acts like a load).

So, changing the $V_{ds}(\text{off})$ is realized by changing the output voltage of the HVSMU only.

Gate Charge Measurement

Figure 5-17 Off voltage change and the results.

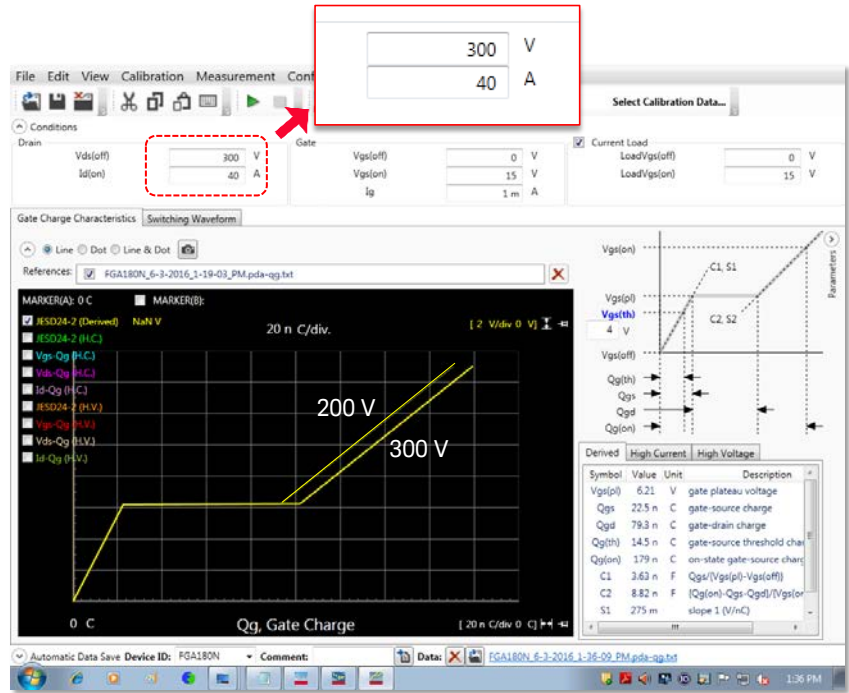

1-3. Measuring a super junction MOSFET

Super junction MOSFET is a new generation of power MOSFET which has higher voltage rating and lower on-current characteristics compared to HV MOSFETs. Also, the super junction FET has smaller FOM ($R_{ds(on)} \times C_{rss}$).

Device used in the example:

The following device is used in the example.

- ✓ Infineon: IPW50R109CE
- ✓ V_{DSS} : 550 V
- ✓ IDM (pulse): 63 A
- ✓ $R_{ds(on)}$: 0.17 Ω

Switching Characteristics

Symbol	Parameter	Test Conditions	Min.	Typ.	Max.	Unit
Q_{gs}	Gate to source charge	$V_{DD} = 400V, I_D = 7.7 A,$ $V_{DS} = 0 \text{ to } 10V$	-	6.1	-	nC
Q_{gd}	Gate to Drain charge		-	24.5	-	nC
Q_g	Gate charge total		-	47.2	-	nC

Q_g example using a default setting:

Q_g measurement example of super junction MOSFET measured using a default setting is shown in Figure 5-18. When using a default settings, abnormal distortion of Q_g curve are observed. When looking at the waveform, there must be an oscillation at the switching period.

Figure 5-18 Q_g example of Super Junction FET using a default setting.

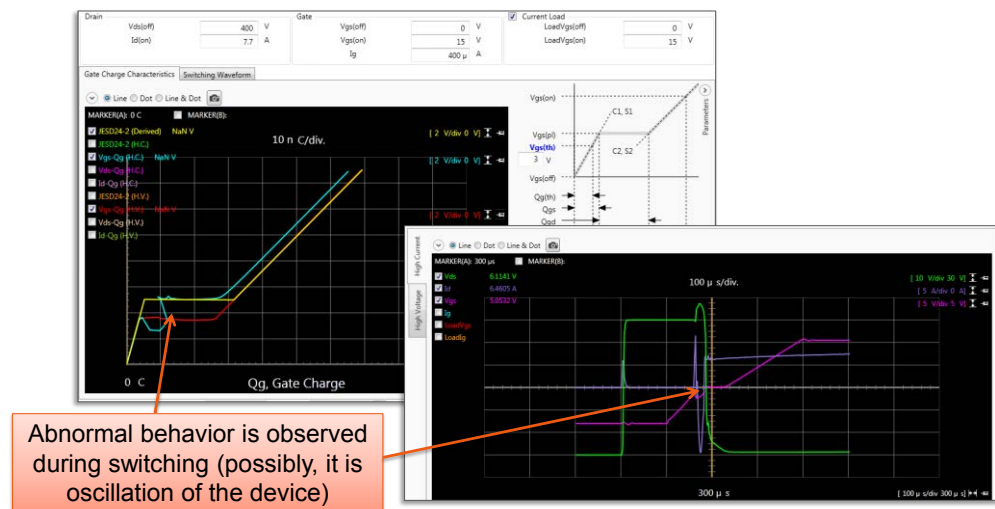

To stabilize the oscillation and make it stable, lowering the $V_{ds(off)}$ in high current (HC) part is useful. In this case, since $I_{d(on)}$ is just 7.7 A, 20 V of $V_{ds(off)}$ is enough when using the 500 A range of the UHCU

Gate Charge Measurement

Normally, the $V_{ds(off)}$ used in HC Q_g measurement part is automatically set as the maximum voltage of the measurement unit. For example, 60 V is set when using UHCU. If the $V_{ds(off)}$ is lower than 60 V, the specified value is used.

UHCU can output up to 500 A at the on status of the device and 60 V at $V_{ds(off)}$ condition. But the maximum output power is extremely large compared to the $I_{d(on)}$ used to measure Q_g of the device, and most of the power (roughly, $= I_{d(on)} \times 60 \text{ V}$) is consumed in the current load FET.

In this operating condition, it is useful to lower the off-state voltage. Lowering the $V_{ds(off)}$ solves following two issues relating the default setup.

- ✓ The current load FET was operated under severe condition (high power loading of about 50 V V_{ds}).
- ✓ The low $V_{ds(off)}$ reduces the dV/dt transient, and it is considered to assure a stable operation.

To change the off-state voltage:

The off-state voltage can be changed in the detailed setup panel. Refer to Figure 5-19 to open the detailed setup panel.

Follow the next step to change the off-state voltage by referring to the number in Figure 5-20.

1. Click to activate the detailed setup. If not, the parameters are automatically filled from the values of the measurement setup.
2. Make $V_{ds(off)}$ low enough to stop the oscillation. For 7.7 A, 20 V is enough when using H51 or H71.

Figure 5-19

To open the detailed setup panel.

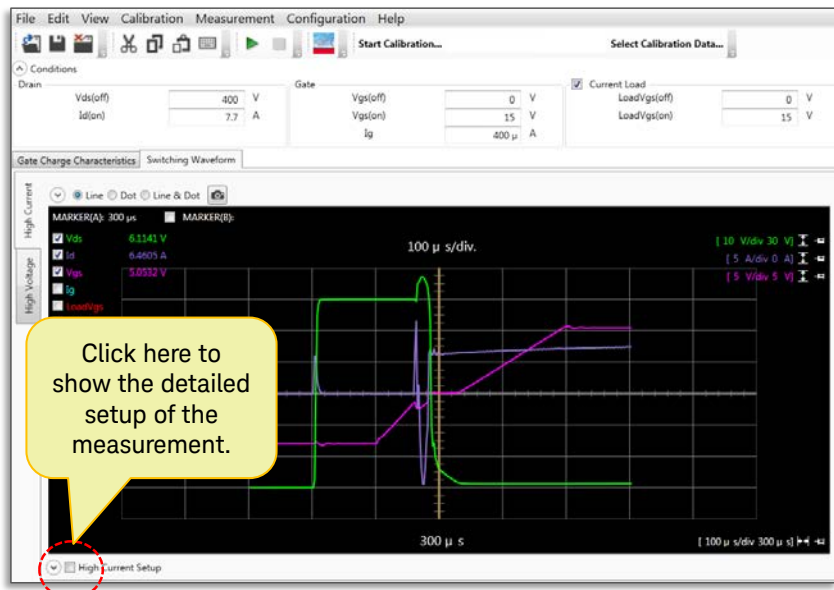

Figure 5-20 Detailed parameter setting for preventing the device oscillation.

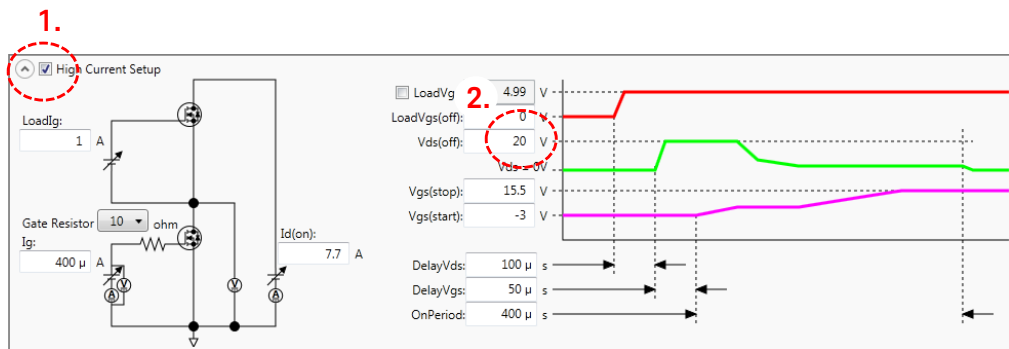
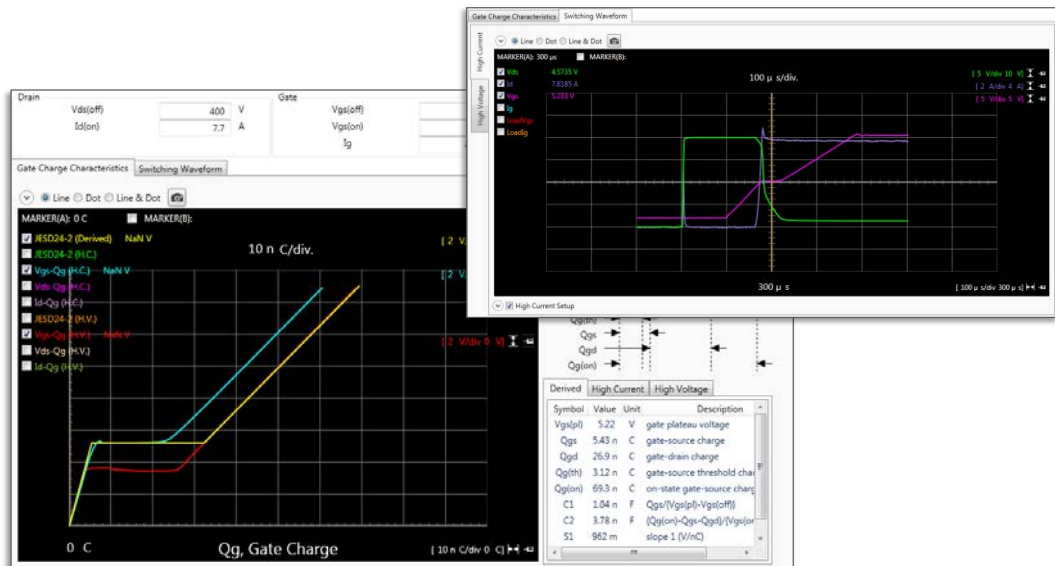

Figure 5-21 shows a measurement result by using 20 V of Vds(off) in the HC part, and the abnormal distortion of Qg curve is disappeared.

Figure 5-21 Qg example of Super Junction FET after lowering the Vds(off) to 20 V.



1-4. SiC MOSFET measurement

SiC is expected as a next generation of material of power devices due to its high breakdown voltage under higher operation temperature.

Qg characteristics of SiC MOSFET:

The Qg characteristics of SiC MOSFET have a unique behavior.

From several SiC datasheets, the Qg characteristics of SiC MOSFET do not have a clear plateau part as defined in the JEDEC standard. Currently, since the Qg extraction method implemented in the B1506A is not valid for such characteristics, it is necessary to estimate Qgd manually extending the measured Qg curves as shown in Figure 5-22.

The sample data is shown:

- Device: CREE CMF20120D
- VDSS: 1200 V
- IDM (pulse): 90 A
- RDS(on): 80 mΩ

By comparing the datasheet curve, the dotted line extracted by manual operation is similar to the Qg listed in the datasheet.

Figure 5-22

SiC Qg measurement example.

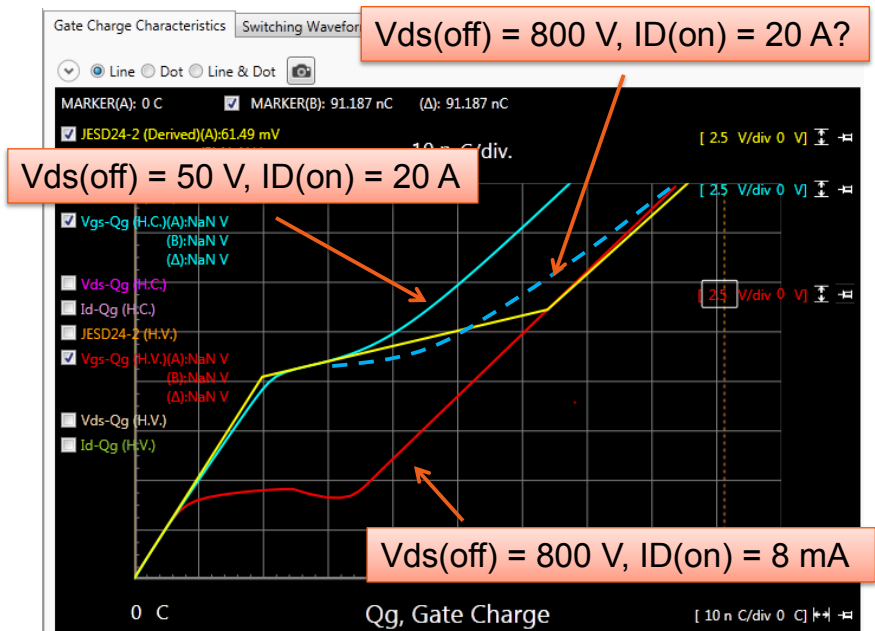

1-5. VGS swing from negative to positive bias

The gate of switching device of converters / inverters is swung from negative voltage to positive voltage to turn the device off/on as fast as possible. Therefore, for estimating a required driving capability of the gate drive circuit, the Qg measured from the negative to positive gate voltage is required.

The problem with the existing Qg solution:

Normally, the Qg test equipment cannot swing the gate voltage by crossing 0 V. Therefore, it is necessary to separate the Qg measurement into two parts; one in the negative gate voltage range, and the other in the positive gate voltage range.

B1506A solution:

Since the B1506A uses MCSMU operated in V Force mode with a current compliance setting, it is possible to swing the gate voltage from negative to positive.

To start the Qg measurement from the negative gate voltage, specify the negative voltage as "Vgs(off)" as shown in Figure 5-23

Figure 5-23

Negative Vgs(off) setting.

Drain		Gate	
Vds(off)	200 V	Vgs(off)	-15 V
Id(on)	40 A	Vgs(on)	+5 V
<input checked="" type="radio"/> turn-on	<input type="radio"/> turn-off	Ig	600 μ A

Since the JEDEC 24-2 based model used in the Qg measurement of the B1506A does not assume the VGS swing from -VGS, the extrapolation curve is made of a physical model of the device and combining the method of JESD24-2.

Figure 5-24 shows raw measurement data of high current (H.C.), high voltage (H.V.) and derived curve.

Figure 5-24 A Qg measurement example of a Vgs from -15 V to +15 V.

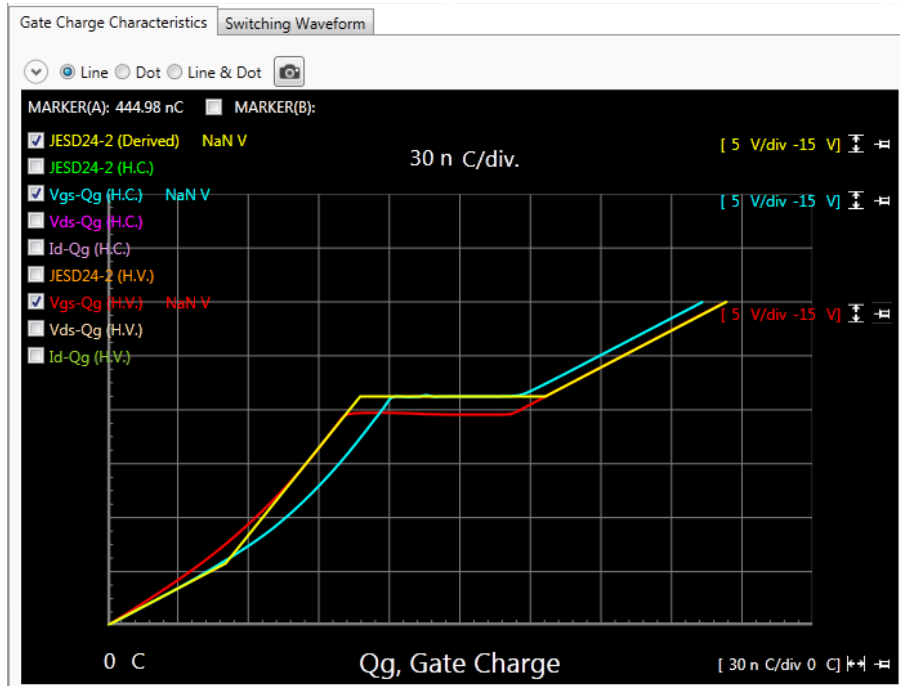

2. Qg measurement using a resistive load

An IGBT module (single) measurement example

An IGBT is used as a switching device for inverters which handle a relatively high power, like the motor control of hybrid vehicles or electric trains.

The device used in the example is shown:

- Device: Fuji Electric 1MB1800U4B
- VCES: 1200 V
- ICE(pulse): 2400 A
- Id(on) of Qg measurement: 800 A

Note:

The Qg measurement range is 1 nC to 100 μ C

The Qg measurement range of the B1506A is 1 nC to 100 μ C, from the measurement cable to the device.

The Qg test equipment available in the market cannot measure such a large Qg (typ. 500 nC is the maximum limit).

Resistive load setting:

In this device, the Id(on) condition to measure the Qg is 800 A, and it is not possible to use the current load FET equipped with the B1506A.

To measure such a high current, resistive load is useful.

Figure 5-25 shows a measurement configuration of the Qg test adapter for resistive load measurement.

1. Remove the current load device.
2. Set the selector switch to "External DUT".
3. The shorting bar has to be removed.
4. Thick cable is used instead of a fixed load resistor because the on-current is too large.

Figure 5-25 A resistive load setup on the Qg measurement adapter.

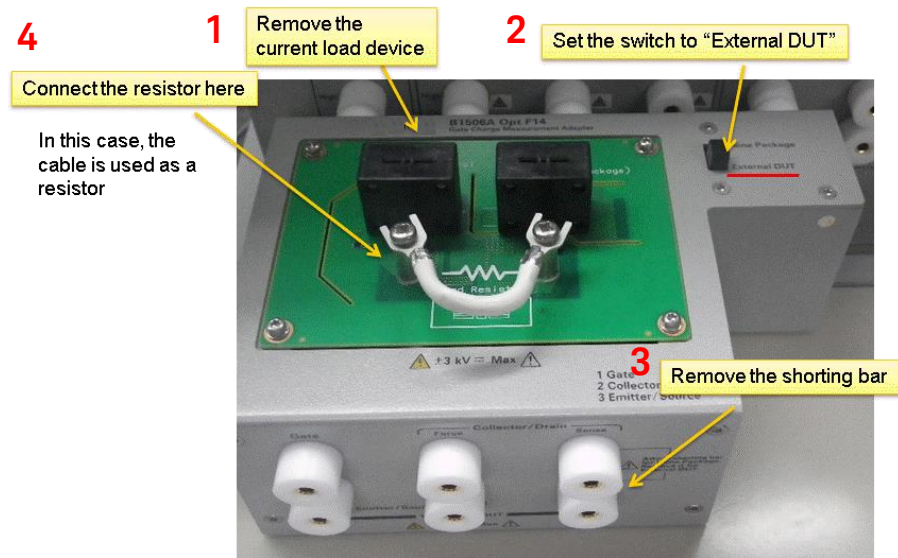

How to determine the Id(on) current:

The output current of the UHCU is determined by the output voltage of the power source, the output resistance of the UHCU and the on-voltage of the device. The output voltage of the UHCU is defined as the Vds(off) in the detailed setup of HC measurement part.

Figure 5-26 shows the simplified measurement block diagram of the HC part of the Qg measurement.

The maximum load resistance RL including the cable connection to the DUT is calculated as follows:

$$RL_{max} + UHCU R_{out} (40 \text{ m}\Omega) = UHCU \text{ max. out V} (60 \text{ V}) / I_{d(on)} (800 \text{ A})$$

This equation can be rewritten as

$$RL_{max} = 60\text{V}/800\text{A} - 40 \text{ m}\Omega = 75 \text{ m}\Omega - 40 \text{ m}\Omega = 35 \text{ m}\Omega.$$

Considering the resistance of the connection cables, realizing a 35 mΩ resistor in total is not realistic. Therefore, as shown in the example #4 of Figure 5-25, the RL is replaced by a thick cable, which is low enough in resistance. In this case, the maximum current is adjusted by the Vds(off) setting of the UHCU.

Figure 5-26 A resistive load setup on the Qg measurement adapter.
High current part of Qg measurement (Resistive load)

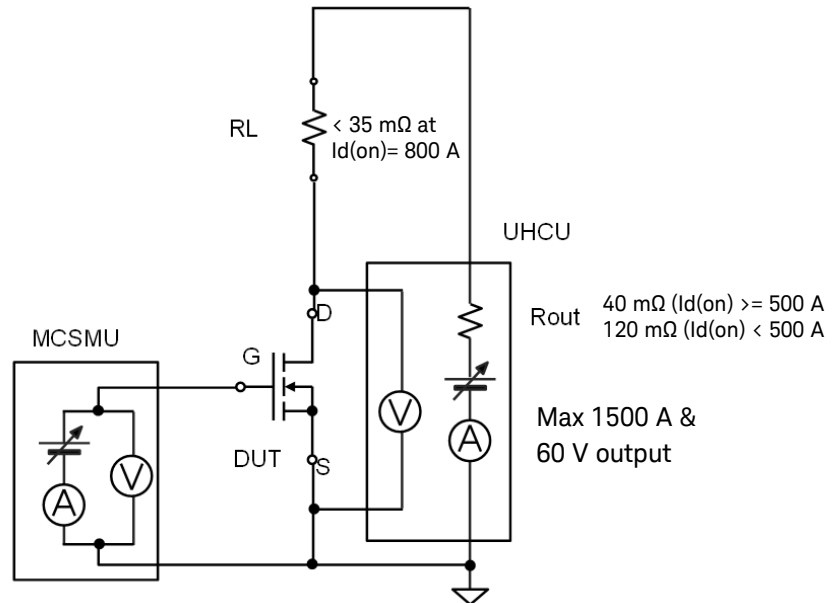

How to connect the IGBT module:

To connect the IGBT module to the Qg test adapter, test leads with alligator clip are used as shown in Figure 5-27.

The detail of output port layout of the Qg test adapter is shown in Figure 5-28.

Note: This adapter does not have a gate low terminal. Only the gate terminal is connected to the gate terminal of the DUT.

Figure 5-27

A connection example for the Qg measurement of the IGBT module.

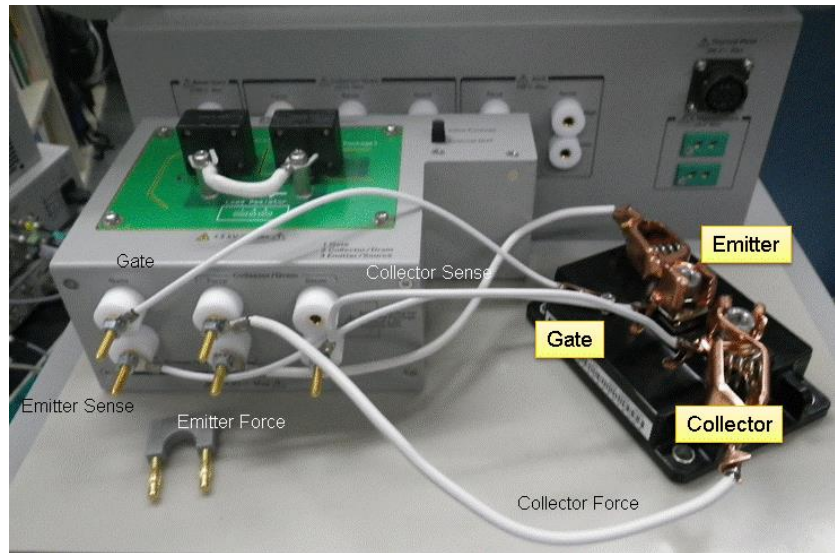
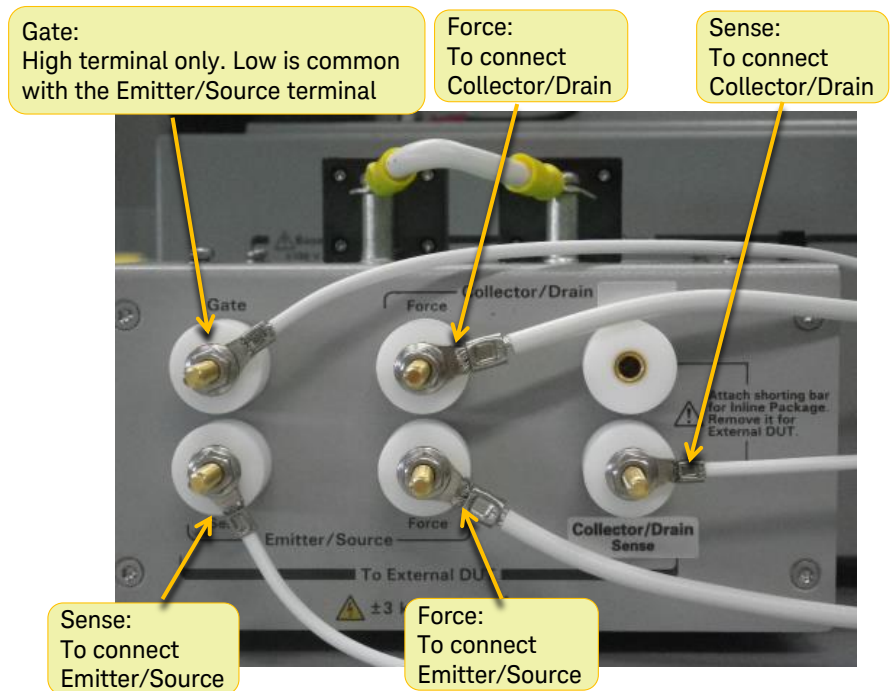

Figure 5-28

The output connection from the Qg adapter.



How to create the measurement setup:

1. Specify $V_{ds(off)}$ and $I_{d(on)}$ to measure the Q_g .
2. Remove the check from the “Current Load”.

Figure 5-29

A setup example of the Q_g measurement using a resistive load.

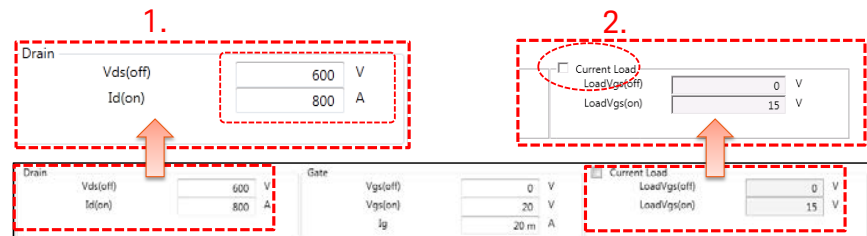

3. Click the “Measure” button to run the measurement. After the measurement, it can be confirmed that the $I_{d(on)}$ is adjusted at 800 A automatically (Figure 5-30, Figure 5-31).

Figure 5-30

Runing a Q_g measurement.

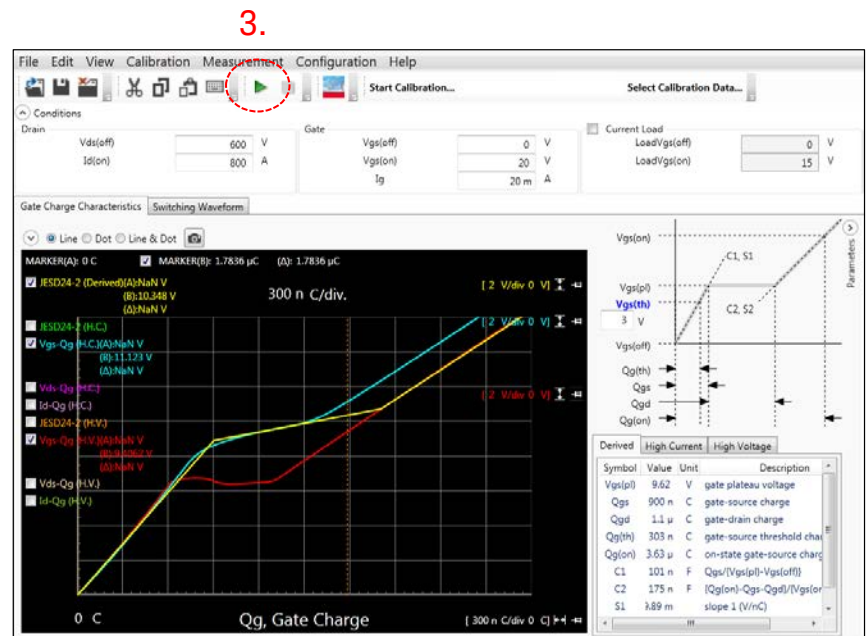
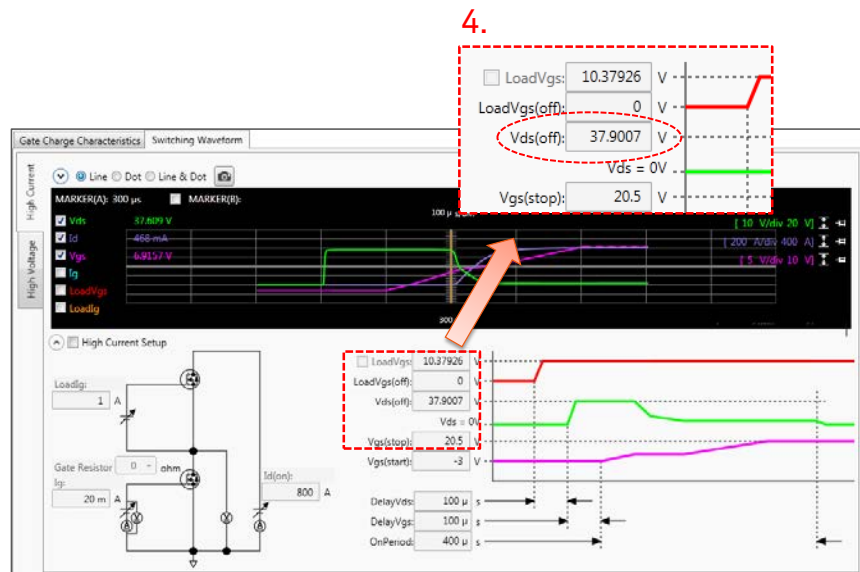

Figure 5-31 Switching the waveform of the measurement.



- In the detailed setup of the high current waveform, the Vds(off) is automatically adjusted to 37.9007 V to make Id(on) = 800 A (Figure 5-32).

Figure 5-32 The Vds(off) is adjusted to automatically to make the Id(on) = 800 A.



Tips: How to set the $V_{ds(off)}$ of a high current Qg measurement manually

To disable the automatic $V_{ds(off)}$ adjustment function when using the resistive load, check “High Current Setup” and specify the $V_{ds(off)}$ as desired value.

Figure 5-33 How to specify the $V_{ds(off)}$ of a high current Qg measurement manually.

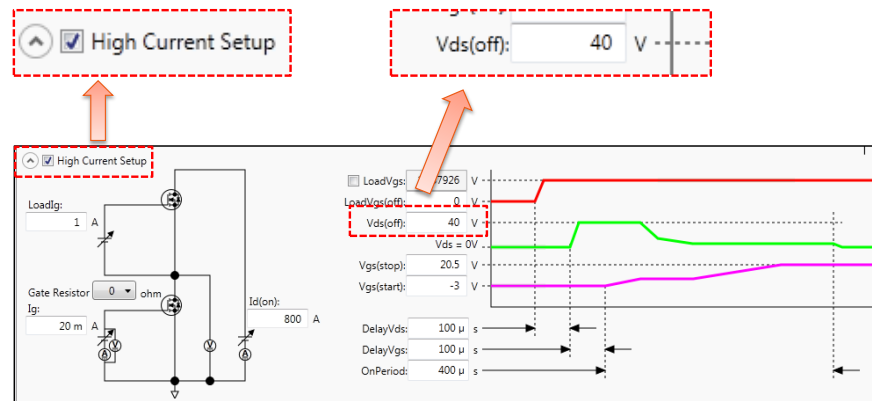

Tips: Maximum $I_{d(on)}$ current

By changing the $V_{ds(off)}$ to 60 V, it is possible to measure the Qg curve at 1280 A $I_{d(on)}$ as shown in Figure 5-34.

This current is determined by the on-voltage of the device and additional resistance by the Qg test adapter (without the Qg test adapter, 1.4 kA is possible with this device used in the example).

Figure 5-34 A 1280 A $I_{d(on)}$ measurement example using the resistive load setting.

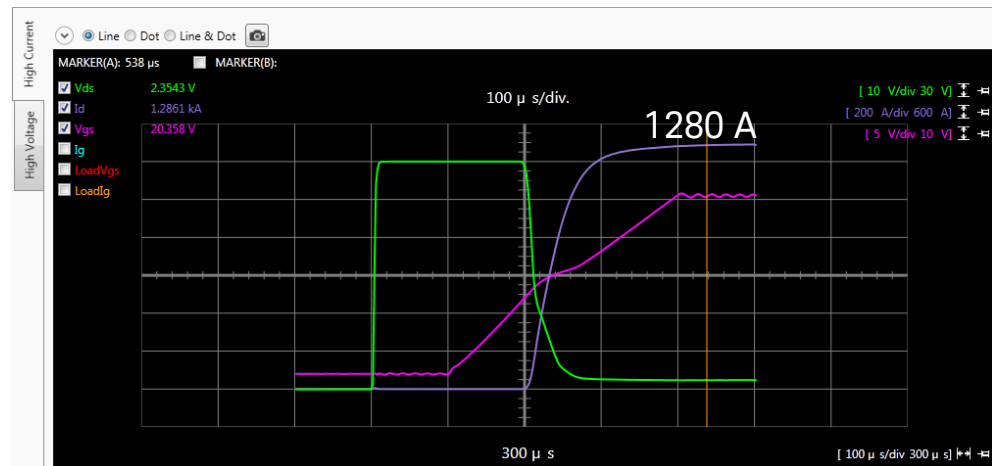

Tips: **How to maximize the on-current of a Qg measurement**

When using the output resistance of the UHCU as a resistive load, it is possible to perform a Qg measurement with the same connection as an IV and CV measurement (Figure 5-35).

Figure 5-35 **Setup using the output resistance of the UHCU as a resistive load.**



In this case, it is possible to use the maximum output current of the UHCU as the on-current of the Qg measurement. Also, it is possible to perform IV, CV and Qg measurements automatically without changing the connection.

Note: To see the plateau part of the Vg-Qg curve, the Vds(off) used for the high current Qg measurement should be larger than the Vgs(on). For example, if the Vgs(on) is 15 V, the Vds(off) should be 20 V or higher. In this case, the minimum on-current, the Id(on) is limited at 166 A (20 V divided by the 120 mΩ output resistance of the UHCU).

To measure the Qg with the Id(on) over 500 A using current load method, it is necessary to connect the devices without using the Qg adapter because the maximum current of the Qg adapter is limited at 500 A.

Figure 5-36 shows an example using a module device as the current load device.

Figure 5-36

A setup using the module device as a current load.

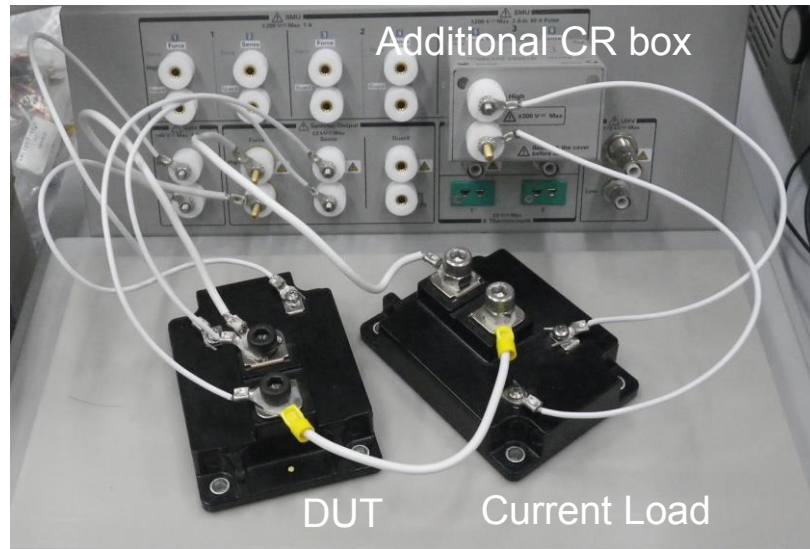

At the gate control of the current load device, a CR filter described in Figure 5-37 is added to avoid oscillation of the device during switching operation. Also, it is used to protect the gate of the device.

Figure 5-37

A CR filter used for setup using a module device as a current load.

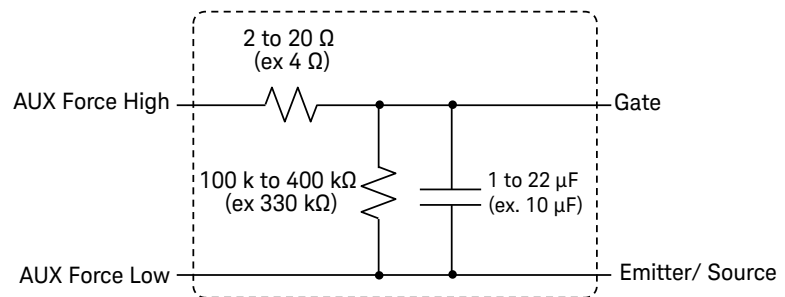

Useful information for using Qg measurement mode

Calibration for gate charge measurement

Calibration is required for gate charge measurement, especially for measuring small devices which Qg is 10 nC or less.

In the Qg calibration, the following two error components are calibrated.

1. Residual resistance calibration:
This calibration compensates the voltage drop of the series resistance in the gate cabling to calibrate the gate voltage accurately.
2. Parasitic capacitance calibration:
This calibration measures the parasitic capacitance in the gate path.

To start calibration:

- ✓ Click the “Start Calibration . . .” label on the top of the Qg measurement mode panel. (Figure 5-38)
- ✓ Calibration panel opens (Figure 5-39)

Figure 5-38 Start of the Qg calibration.

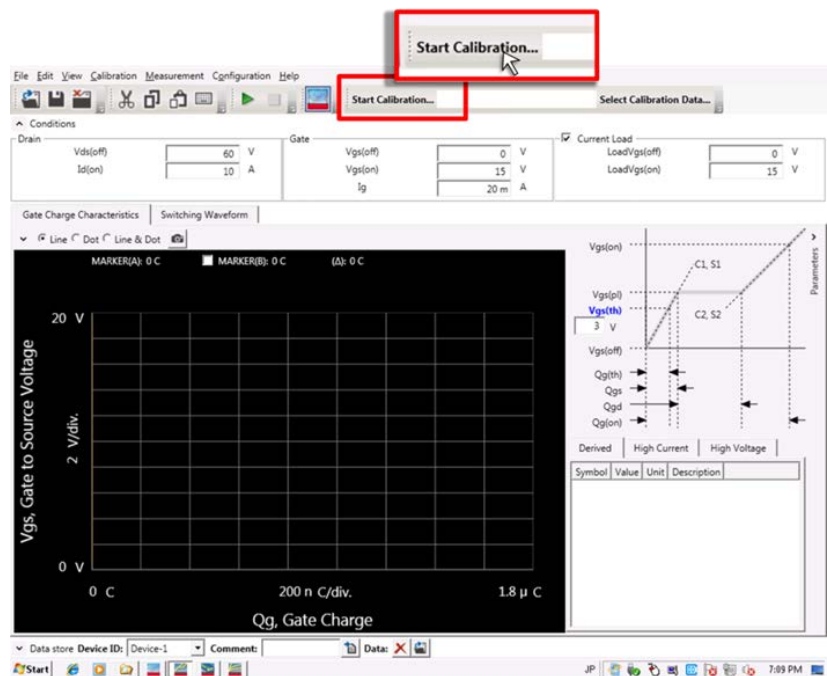

In the calibration, the following items shown in the following list are measured. For each calibration items, refer to the corresponding number in Figure 5-39.

1. "Residual Resistance (Rr)" calibration measures the residual resistance (Rr) in the gate control path of the B1506A test fixture for each built-in Gate resistance.
Rr includes both the residual resistance in the gate measurement path, and the resistance error of the built-in resistance.
2. "Parasitic Capacitance (Cp)" calibration measures the parasitic capacitance Cp in the gate path, including the output capacitance of each current range of the MCSMU which drives the DUT's gate
3. "User Series Resistance (Ru)" is an additional resistance, which is inserted between the gate terminal of the Qg measurement adapter to the gate terminal of DUT. This resistor is typically inserted to avoid an oscillation of the DUT.

Figure 5-39 Default Calibration panel for Qg measurement.

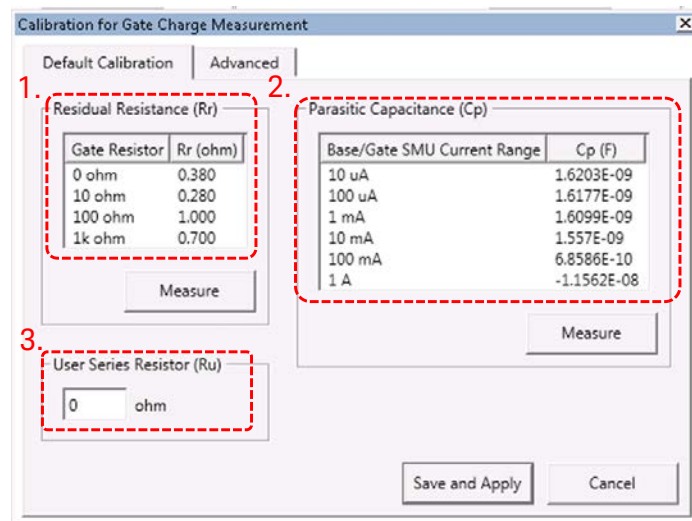

Default and Advanced calibration

- ✓ In the "Default Calibration" tab, the residual resistance and the parasitic capacitance are measured with pre-defined measurement conditions.
- ✓ In the "Advanced" tab as shown in Figure 5-40, more accurate compensation can be performed.
The advanced mode measures the parasitic capacitance using the actual measurement conditions of the DUT.
The advanced calibration is required when measuring a small Qg of typically less than 1 nC.

Figure 5-40 Advanced calibration panel for Qg measurement.

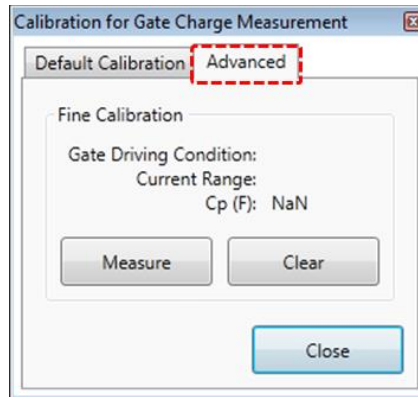

TO-package device calibration

To measure the compensation factor for TO-packaged devices, attach the Qg test adapter to the test fixture, and confirm the following points as shown in Figure 5-41.

1. Set the mode switch to “Internal Package”.
2. Confirm the shorting bar is attached to the collector/source output terminals of the Qg test adapter.

Figure 5-41 TO-device fixture calibration for Qg measurement.

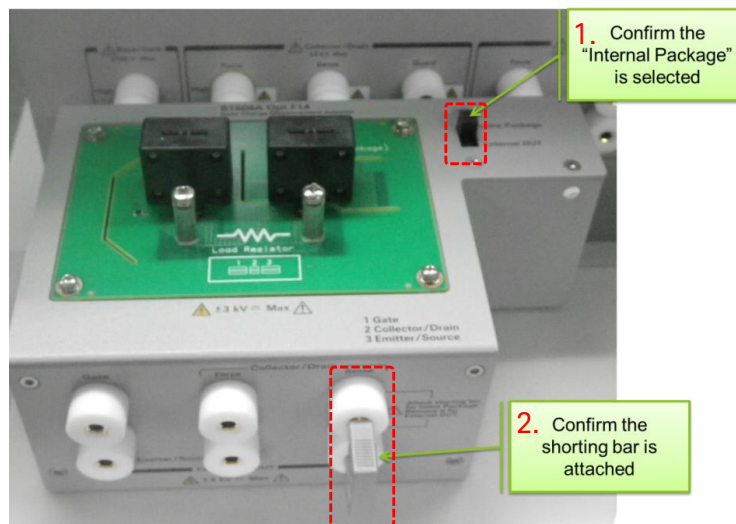

How to measure residual resistance:

Click the “Measure” button of the residual resistance box.

3. A window opens to confirm the shorting the DUT terminals as shown in Figure 5-42.

Figure 5-42 Short confirmation window for R_r calibration.

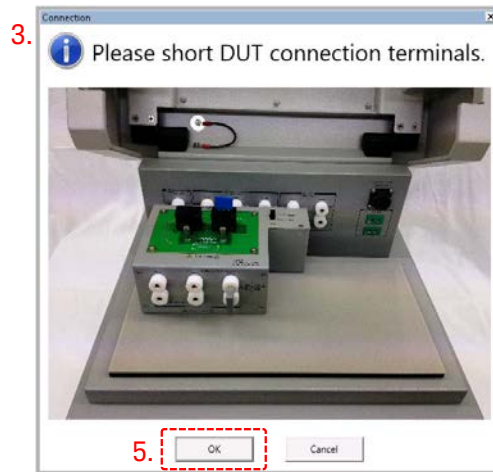

4. Insert the shorting bar, which is equipped with the B1506A, to the TO socket as shown in Figure 5-43.
5. After confirming the input terminals of DUT are shorted, click “OK” (Figure 5-42) and residual resistances are measured.

Figure 5-43 Shorting adapter.



How to measure parasitic capacitance:

To measure compensation factors of the parasitic capacitance, click the "Measure" button of the parasitic capacitance box.

6. "Open DUT connection" confirmation window opens as shown in Figure 5-44.
7. Remove the shorting bar from the DUT socket and click "OK" to measure the compensation factors for the parasitic capacitances.
8. After finishing measurement of the compensation data, click "Save and Apply" to set those compensation data effective as shown in Figure 5-45.

Figure 5-44

Open confirmation window for Cp calibration.



Figure 5-45

Save and apply the calibration data.

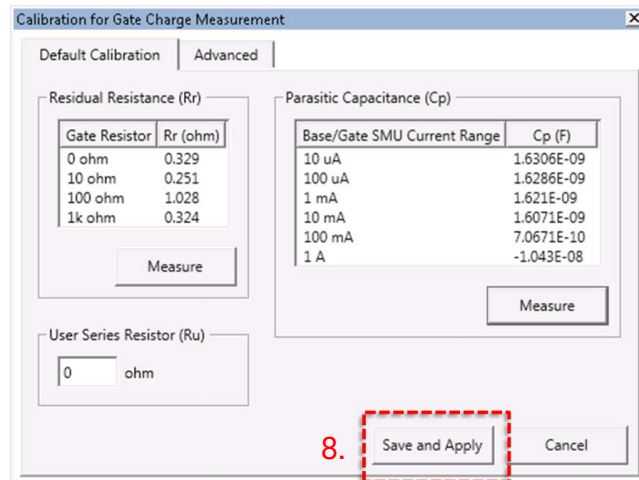

Tips:**How to measure the parasitic capacitances more accurately:**

9. To measure the parasitic capacitances more accurately, click the “Advanced” tab as shown in Figure 5-46.
10. Click the “Measure” button.
The Cp is measured by using the actual measurement parameters.
11. Click :“Close” to finish the measurement.
Then click “Save and Apply” (#8 of Figure 5-45) to make those compensation data effective.

Figure 5-46 Advanced Cp calibration.

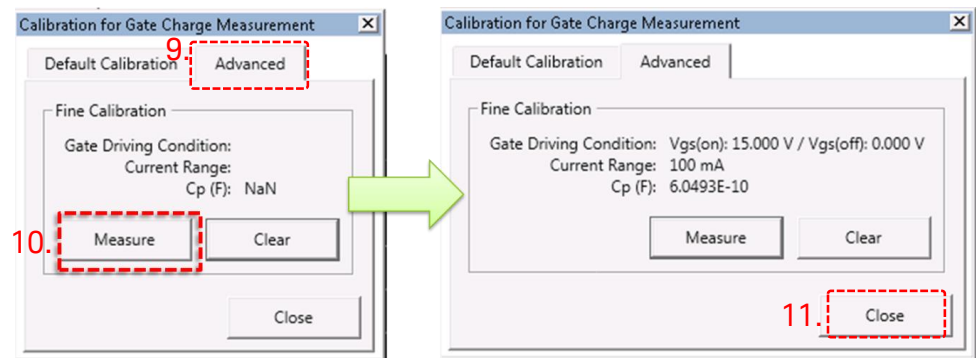
**Module device calibration**

To measure devices which pins are not compatible with the TO inline socket adapter, use the “External DUT” mode of the Qg test adapter. Follow next two steps to prepare the calibration.

1. Move the mode switch to the “External DUT”.
2. Remove the shorting bar from the collector/drain output terminals as shown in Figure 5-47.

Figure 5-47 Module device calibration setting.

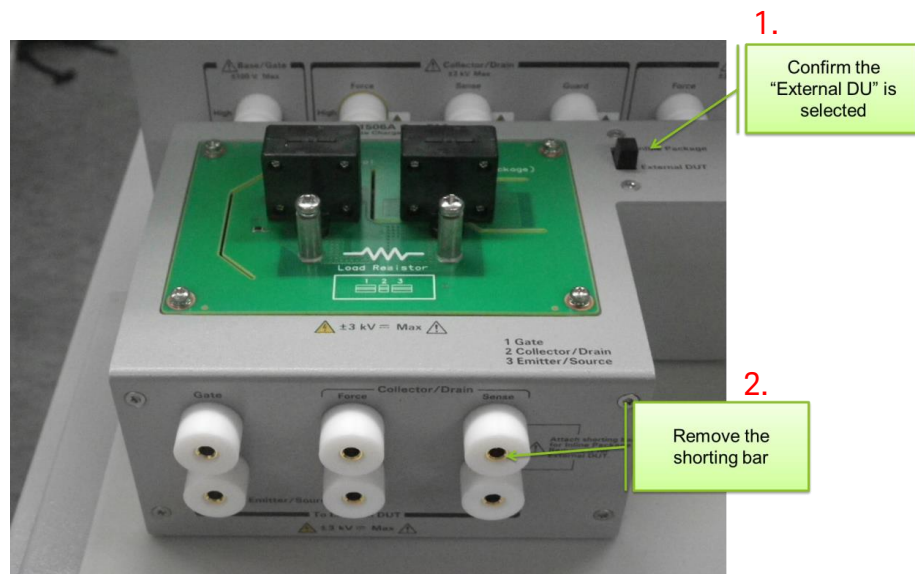

Ho to measure residual resistance:

Connect the test leads to the output terminals of the Qg test adapter and connect the other end of all the cables together to measure the residual resistance as shown in Figure 5-48.

Figure 5-48 Module device's short calibration.

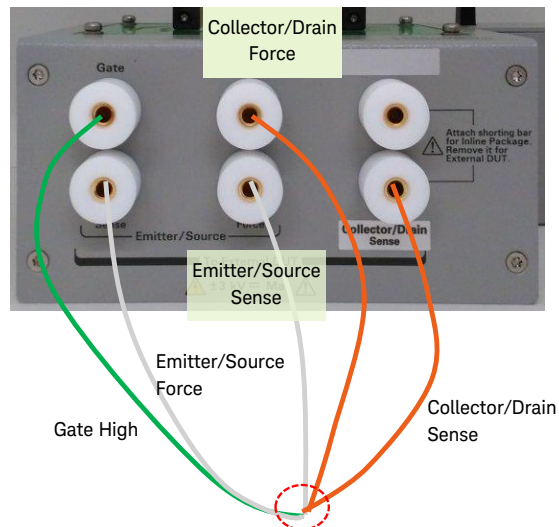

Note: If a dummy DUT of the same package type, which terminals are shorted internally, is available, use it to create short connection.

How to measure parasitic capacitance:

To measure the parasitic capacitances, follow the next steps shown in Figure 5-49.

1. Connect the end of the collector connection's force and sense lines.
2. Connect the emitter connections' force and sense lines.
3. The end of the gate cables is kept open. (Refer to Figure 5-49)

Figure 5-49

Module device's open calibration.

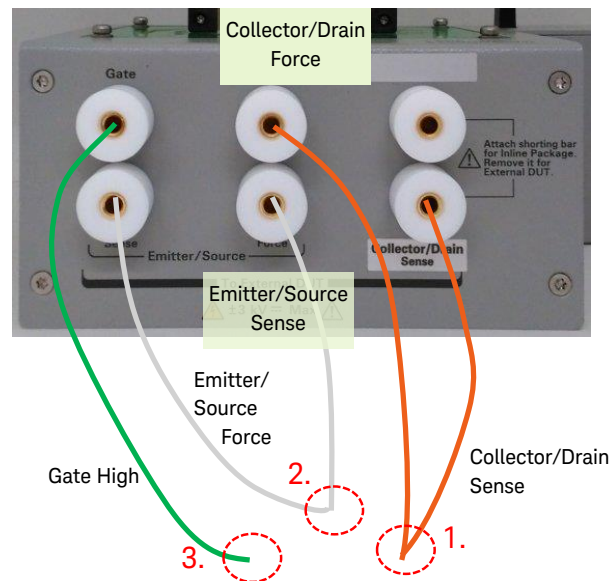
**Note:**

If a dummy DUT of the same package type, which terminals are open internally, is available, Use it to make open connection.

Brief idea of the gate charge measurement setup

Figure 5-50 shows an example test setup start panel of the Gate Charge Measurement mode GUI. There are several test setup panels behind this GUI. This section briefly introduces the location of major parameter input parameters.

Follow the next numbers for the major parameter descriptions and the input locations by referencing to the corresponding number in the figure.

Figure 5-50 Start panel example of the Gate Charge Measurement panel.

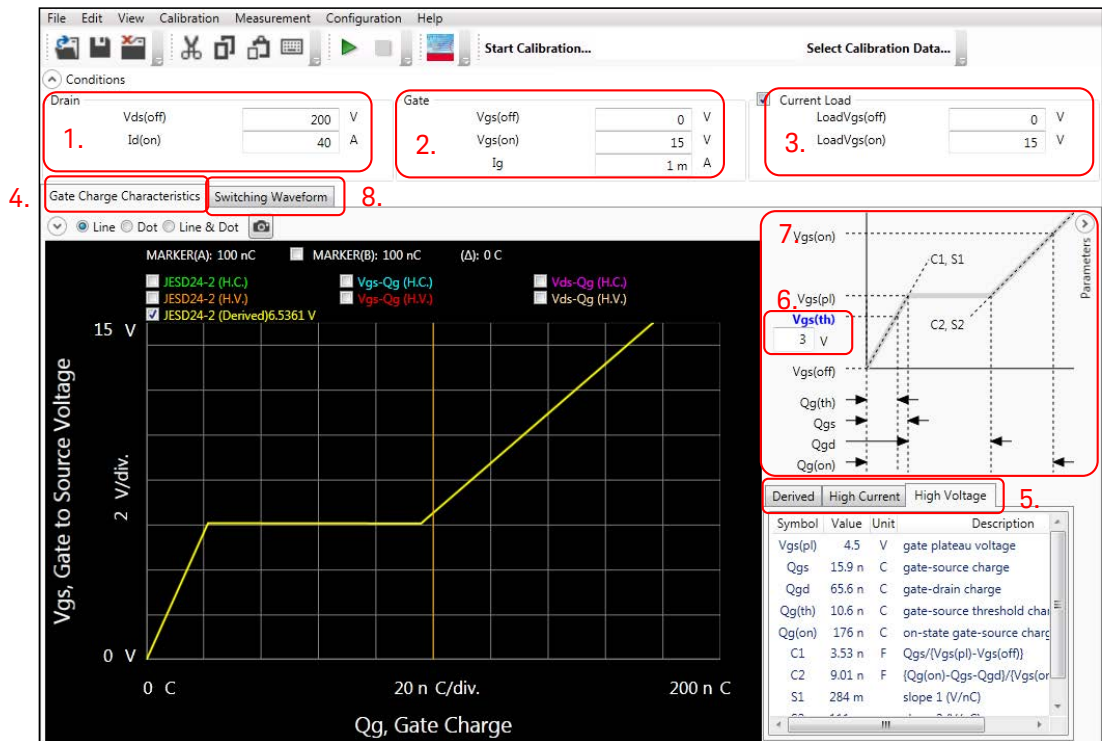

1. Drain parameters to measure Qg
 - Vds(off) voltage
 - Id(on) current
2. Gate parameters of minimum and maximum voltage used in the measurement.
 - Vgs(off) voltage
 - Vgs(on) voltage
 - Ig (gate force current) to use in the Qg measurement.
3. Current load FET/IGBT data
 - LoadVg(off): Vg(off) voltage of the load FET/IGBT
 - LoadVg(on): Maximum Vg(on) voltage of the load FET/IGBT

4. Gate Charge Characteristics tab
This tab shows,
 - V_g - Q_g derived characteristics curve, and the following items from the following #5 to 7.
5. $V_{gs(pl)}$, Q_g , capacitance and slope of Q_g curve for the following tab items:
 - High current measurement results
 - High voltage measurement results
 - Derived results from the above two measurement
6. V_{th} input to calculate $Q_g(th)$ of the test device.
7. The definition of the Q_g parameters and the relation to the Q_g curve.
8. Clicking "Switching Waveform" tab opens Figure 5-51. Refer to this figure for the following items.

Figure 5-51 Start panel example of the Gate Charge Measurement panel.

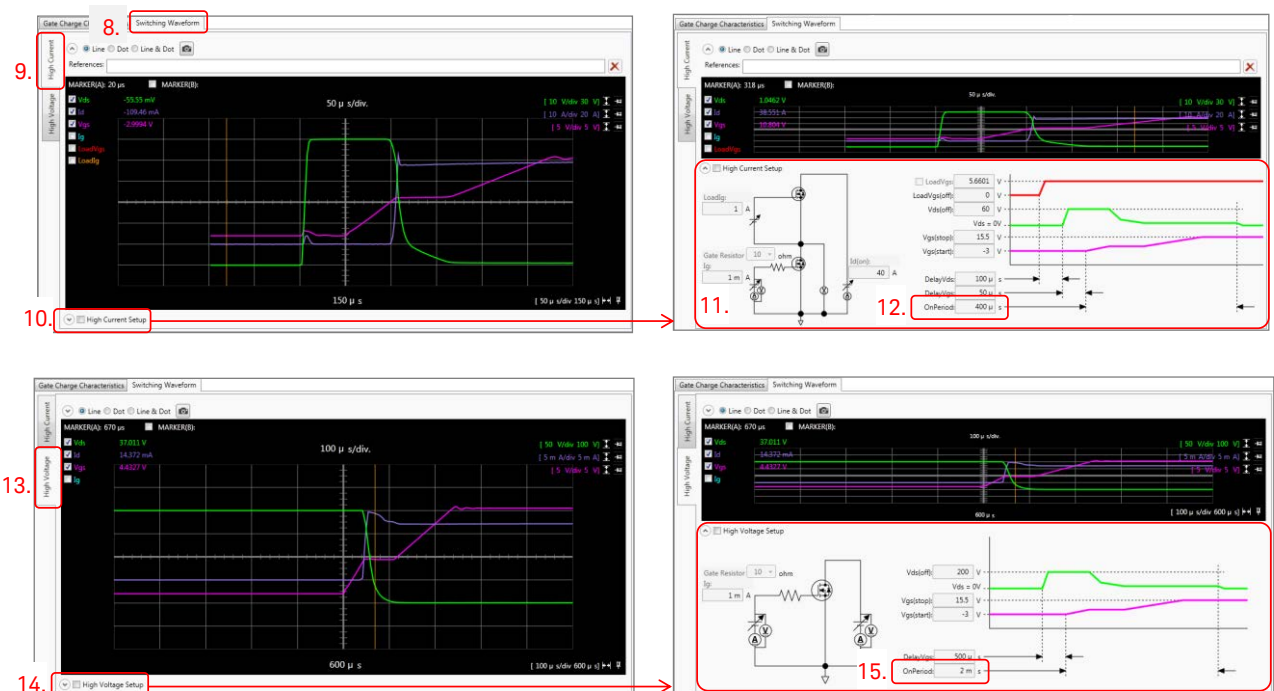

9. "High Current" tab can show the following raw measurement data of the Q_g measurement.
 - V_{ds}
 - I_d
 - V_{gs}
 - I_g
 - Load V_{gs}
 - Load I_g
10. Clicking "High Voltage Setup" opens the timing parameter setup panel for high current Q_g measurement.

Gate Charge Measurement

11. In the Qg setup panel, the simplified measurement block diagram is shown, and the pulse measurement parameter can be set up.
12. The drain pulse on period is an important parameter, especially to protect the current load FET/IGBT to be damaged in the on period of the DUT where full load power of UHCU is consumed (maximum 22.5 kW for example).
13. Clicking the "High Voltage" tab, and it shows the equivalent items shown in the step 9 above.
14. Clicking "High Voltage Setup" opens the timing parameter setup panel for high voltage Qg measurement.
15. "On period" of HVSMU can be set.

This information is subject to change without notice.
© Keysight Technologies 2015, 2016
Edition 2, August 2016



B1506-90500
www.keysight.com