

**ebm-papst St. Georgen GmbH & Co. KG**

Hermann-Papst-Str. 1
 D-78112 St. Georgen
 Phone +49 (0) 7724 81-0
 Fax +49 (0) 7724 81-1309
 info2@de.ebmpapst.com
 www.ebmpapst.com

Nominal data

Type	4118 NH6	
Nominal voltage	VDC	48
Nominal voltage range	VDC	36 .. 60
Speed	min ⁻¹	8400
Power input	W	62
Min. ambient temperature	°C	-20
Max. ambient temperature	°C	65
Air flow	m ³ /h	440
Sound power level	B	8.1
Sound pressure level	dB(A)	73

ml = max. load · me = max. efficiency · fa = running at free air · cs = customer specs · cu = customer unit
 Subject to alterations



Technical features

Mass	0.390 kg
Dimensions	119 x 119 x 38 mm
Material of impeller	Fiberglass-reinforced PA plastic
Housing material	Aluminum with grounding lug for screw M4 x 8 (TORX).
Direction of air flow	Inlet over bars
Direction of rotation	Clockwise, looking at rotor
Bearing	Ball bearings
Lifetime L10 at 40 °C	60000 h
Lifetime L10 at maximum temperature	32500 h
Connection line	Single strands AWG 22, UL 1007, TR 64, bared and tin-plated.
Motor protection	Protected against reverse polarity and locking.
Approval	VDE, CSA, UL

Product drawing

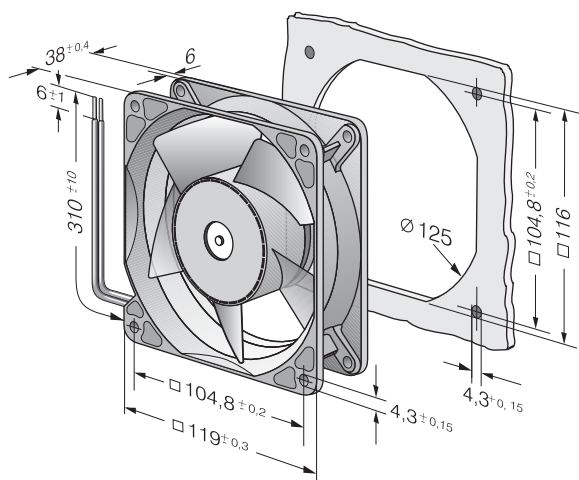

Charts: Air flow

