



# DURAG

D-LX 200  
D-LX 720

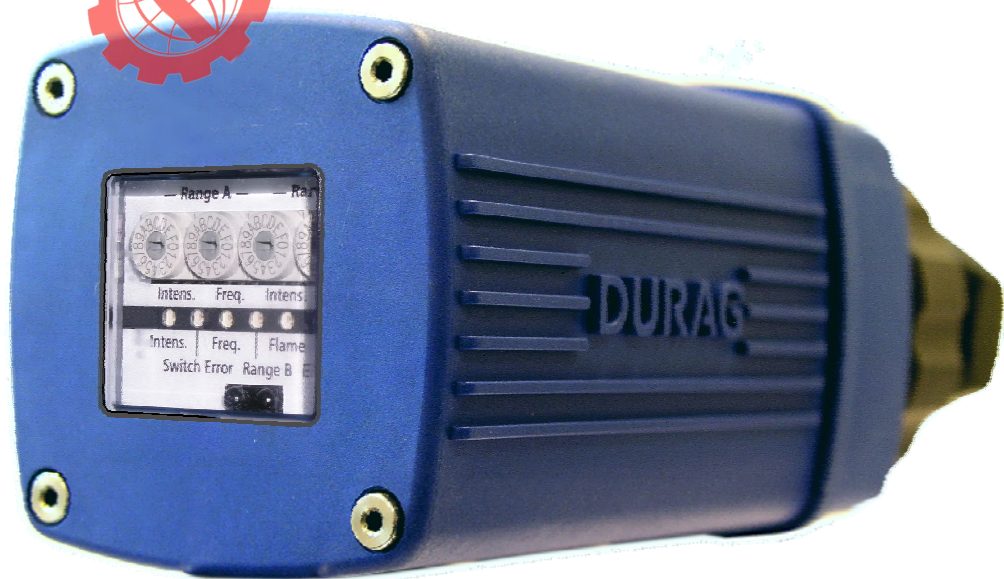

## Compact Flame Monitor

# Manual



## DURAG GROUP

### Translation of the original operating manual Compact Flame Monitor D-LX 200, D-LX 720

Document:	man_dlx200_720_1_uk.doc		
Version:	01.01.2009 -1		
Last update:	15.01.2009		
Print date:	03.03.2009		
European inspection base:	EN 298 (2003)	EN 230 (2005)	
Fuel / Device:	Gas	Öl	
Register number:			
Inspected by TÜV Süddeutschland			
Approved for intermittent operation, continuous operation and 72-hour operation. Registered by DVGW			

**DURAG GmbH**  
Kollaustraße 105  
22453 Hamburg

Telephone: +49 (40) 55 42 18 – 0  
Fax: +49 (40) 58 41 54  
E-Mail: [info@durag.de](mailto:info@durag.de)  
Internet: [www.durag.de](http://www.durag.de)

This documentation

- (approx. 117 pages) has been compiled with the greatest care. However, all liability must be excluded.
- is not intended for the US American market. Documentation in accordance with ANSI Z535 standard can be requested. Reference addresses can be found on page 115.
- or parts of it may not be duplicated, transmitted or translated into other languages, independent of which way and through which means this happens, electronically or mechanically, without the explicit permission of DURAG GmbH.
- refers to the complete equipment in principle, even if individual program modules or devices (device parts) have not been purchased.
- refers to the current status of the equipment design at the time of updating this documentation (see above).
- can be changed without notice with regard to content.

© DURAG GmbH 2009 Editorial staff: Herbert Lange.  
All rights reserved.



DURAG creates the German original version of this operation handbook and the English translation of the original version. DURAG checks for the correctness of these editions

For all other language specific versions DURAG GmbH takes no responsibility.  
In doubts, the original version is valid.

## Contents

<b>0</b>	<b>Foreword</b>	<b>7</b>
<b>1</b>	<b>General</b>	<b>11</b>
1.1	Brief overview of the contents	11
1.2	Typographical conventions	12
1.3	Meaning of the warnings and notes used	12
<b>2</b>	<b>Safety Instructions</b>	<b>17</b>
2.1	General safety instructions	17
2.2	Hazard from electrical equipment	18
2.3	Hazard from hot, aggressive or explosive gases	18
2.4	Hazard to the device due to purge air failure	19
2.5	Proper use	20
2.6	Prevention of consequential damages in the event of system malfunction	20
2.7	Qualified personnel	20
<b>3</b>	<b>Product Description</b>	<b>25</b>
3.1	Notes on delivery	25
3.2	Scope of supply / Design variants	25
3.3	Special accessories (optional)	26
3.4	Options	27
3.5	Notes on the product	27
3.6	Fields of application, intended use	27
3.7	Selection criteria for Compact Flame Monitor D-LX 200, D-LX 720	28
3.8	Conformity/Approvals	28
3.9	Identification of the product	30
3.10	Notes on warranty	30
<b>4</b>	<b>Design and Function</b>	<b>33</b>
4.1	Functional description	33
4.2	Device description	36
<b>5</b>	<b>Installation, Commissioning</b>	<b>43</b>
5.1	Safety	43
5.2	Transport	44
5.3	Installation	44
5.4	Commissioning	50
<b>6</b>	<b>Adjusting the Flame Monitor</b>	<b>53</b>
6.1	Adjusting the thresholds	54
6.2	Setting the gain characteristic curve	57
6.3	Range selection	59
6.4	Setting the Modbus address	59
6.5	Setting process	59
6.6	Safety time	64
<b>7</b>	<b>D-LX 200 InformationCentre PC Version</b>	<b>69</b>
7.1	System requirements	69
D-LX 200, D-LX 720		<b>3</b>

7.2	Installation	69
7.3	Start / Execute	69
7.4	Pull-down menus	75
7.5	Error messages	77
7.6	Structure of the stored data records	77
<b>8</b>	<b>Modbus</b>	<b>83</b>
8.1	Hardware and boundary conditions	83
8.2	Setting the Modbus slave address	83
8.3	Modbus	85
8.4	DURAG Modbus DataMap	88
<b>9</b>	<b>Maintenance</b>	<b>95</b>
9.1	Customer service information	95
9.2	Safety	95
9.3	Maintenance intervals	96
9.4	Maintenance tasks	96
9.5	Fault	96
<b>10</b>	<b>Technical Data</b>	<b>101</b>
10.1	Technical data of the basic device	101
10.2	Factory settings (default)	102
10.3	Technical data for the integrated flame sensor	102
10.4	Presettings	102
<b>11</b>	<b>Plans and Drawings for D-LX 200, D-LX 720</b>	<b>103</b>
11.1	Wiring diagram D-LX 200, D-LX 720	103
11.2	Dimensional drawings	104
<b>12</b>	<b>Declaration of conformity</b>	<b>107</b>
<b>13</b>	<b>Glossary</b>	<b>109</b>
<b>14</b>	<b>Index</b>	<b>111</b>
<b>15</b>	<b>DURAG GROUP company addresses</b>	<b>115</b>

## Index of illustrations

Figure 4.1: System overview D-LX 200 .....	33
Figure 4.2: System overview D-LX 720 .....	33
Figure 4.3: Block diagram.....	34
Figure 4.4: D-LX 200 .....	36
Figure 4.5: Exploded drawing D-LX 200.....	38
Figure 4.6: Exploded drawing D-LX 720.....	39
Figure 5.1: Safety screw .....	44
Figure 5.2: Dimensional drawing of swivel mount (optional for D-LX 200) D-ZS 033-I.....	45
Figure 5.3: Location of the fuses .....	46
Figure 5.4: Wiring diagram D-LX 200, D-LX 720 .....	47
Figure 5.5: Elimination of the potential isolation.....	48
Figure 5.6: Volume flow depending on the purge air.....	49
Figure 5.7: Purge air connection .....	49
Figure 6.1: Printed circuit board numbering .....	54
Figure 6.2: Front panel D-LX 200 .....	55
Figure 6.3: Setting Intensity.....	55
Figure 6.4: Flicker frequency setting [Hz] of the flame .....	56
Figure 6.5: Gain characteristic curves.....	57
Figure 6.6: PCB no.2, (→) DIP switches S3 and S4 .....	58
Figure 6.7: Flow chart for settings by means of current output/LED .....	61
Figure 6.8: Flow chart for settings by means of InformationCentre .....	63
Figure 7.1: InformationCentre front screen.....	70
Figure 7.2: "Connection" menu of the InformationCentre.....	71
Figure 7.3: Display view of the InformationCentre .....	71
Figure 7.4: Display view Flame Information .....	72
Figure 7.5: Signal for a measuring cycle .....	73
Figure 7.6: System Settings .....	74
Figure 7.7: "File" menu .....	75
Figure 7.8: "FileSetting" submenu .....	75
Figure 7.9: "Adjust CurrentOutput" submenu .....	76
Figure 7.10: Extra window with error message .....	77
Figure 8.1: PCP no.4, jumper X2" .....	84
Figure 8.2: PCB no.2, (→) DIP switch S5.....	84
Figure 11.1: Wiring diagram D-LX 200, D-LX 720.....	103
Figure 11.2: Dimensional drawing D-LX 200.....	104
Figure 11.3: Dimensional drawing D-LX 720.....	105

## Index of tables

Table 3.1: Default settings for D-LX 200, D-LX 720 .....	27
Table 3.2: Suitability of device variants (spectral ranges).....	28
Table 3.3: Device approvals .....	29
Table 4.1: Meaning of the LEDs .....	40
Table 5.1: Requirements for operation checklist.....	50
Table 6.1: Setting MODE switches S3 and S4.....	58
Table 6.2: Setting MODE switches S3 and S4.....	65
Table 7.1: System Settings.....	74
Table 7.2: Data record structure.....	79
Table 8.1: Setting the jumper X2 .....	84
Table 8.2: Setting for MODE switch S5.....	85
Table 8.3: Modbus RTU Message Frame .....	85
Table 8.4: Modbus Slave Address Range .....	85
Table 8.5: Modbus FunktionCode .....	86
Table 8.6: Modbus FunctionCode(0x03..0x04) Read 16BitRegisters Request.....	86

Table 8.7: Modbus FunctionCode(0x03..0x04) Read 16BitRegisters Response .....	86
Table 8.8: Modbus FunctionCode(0x10) Write Multiple 16BitRegisters Request .....	87
Table 8.9: Modbus FunctionCode(0x10) Write Multiple 16BitRegisters Response .....	87
Table 8.10: Modbus register and address information .....	88
Table 8.11: Modbus register and device-specific address information .....	89
Table 9.1: Error messages .....	97
Table 10.1: Technical data of the basic device .....	101
Table 10.2: Factory settings (default) .....	102
Table 10.3: Technical data for the integrated flame sensor .....	102
Table 10.4: Presettings .....	102



## 0 Foreword

The purpose of this manual is to help you to become acquainted with your DURAG product.

In this publication you will find information and technical data on planning, installation / commissioning, operation and maintenance of the D-LX 200, D-LX 720.

The two device types D-LX 200 and D-LX 720 are identical in design, apart from the respective optics. Therefore both designations are always specified in this manual, separated by a comma. The differences, exclusively in the front part of the devices (the D-LX 720 is intended for use with an optional fibre-optic system), are described in the relevant chapters, identified accordingly.

The functional diagram of the complete system and the device components complete this information.

Our aim is to make a decisive contribution to your success with our products and services. We hope that the information provided here will enable us to do so.

Flame monitors are safety devices and are designed to ensure the safe operation of a furnace plant.

The adjustment of flame monitors should therefore only be performed by appropriately trained personnel. DURAG offers suitable training for this purpose.

Should you have any further questions on products or applications from the DURAG GROUP, please use our Support & Service!

You will find the relevant addresses and telephone numbers on page 115 (DURAG GROUP company addresses).

Further information is also available from [www.durag.de](http://www.durag.de)

Please read this manual carefully before commissioning the Compact Flame Monitor! The information provided is important for your safety and for preventing damage to the D-LX 200, D-LX 720 and to the environment.





---

D-LX 200

D-LX 720

# Compact Flame Monitor



---

## 1 General

- 1.1 Brief overview of the contents
- 1.2 Typographical conventions
- 1.3 Meaning of the warnings and notes used



# 1 General

The product described in this manual left the factory in perfectly safe and inspected condition. In order to maintain this condition and to achieve correct and safe operation of this product, it may only be used as described by the manufacturer. In addition, faultless and safe operation of the product requires appropriate transport, correct storage and installation, as well as careful operation and maintenance.

Flame monitors are safety devices and are designed to ensure the safe operation of a furnace plant. For this reason flame monitors are type-approved devices; any interventions or modifications to them will result in loss of the approval. Repairs may therefore only be carried out by the manufacturer or his representatives.

This manual contains information necessary for the normal use of the Compact Flame Monitor D-LX 200, D-LX 720. It is intended for technically qualified personnel who have been familiarised with the product, who are specially trained or have pertinent knowledge in the field of measurement and control engineering.

The knowledge and the technically flawless implementation of the safety instructions and warnings contained in this manual are necessary for the safe assembly and commissioning as well as for the safety during operation and maintenance of the described product. Only appropriately qualified personnel have the necessary expertise to interpret the safety instructions and warnings provided in a general manner in this document correctly in concrete individual cases and to apply the appropriate procedure.

This manual is an integral component of the scope of delivery, even if due to logistical reasons the possibility of an issue on CD and the separate ordering or respectively delivery have been provided for. For reasons of clear arrangements it does not contain all details about all versions of the described product, and can also not take every possible case for installation, operation, maintenance and application of the systems into consideration.

If you require further information or if problems occur which are not dealt with in sufficient detail in this document, please ask your competent DURAG GmbH representative for the required information (see page 115).

## 1.1 Brief overview of the contents

This manual describes the following areas:

- |                         |   |
|-------------------------|---|
| <b>Chapter 1 + 2</b>    | Information on use of the manual, the pictograms used, safety instructions and requirements on operating and maintenance personnel.   |
| <b>Chapter 3 – 4</b>    | Information on the product, technical data, function and system descriptions as well as the available options.  |
| <b>Chapter 5 – 9</b>    | Information for the use of the product D-LX 200, with regard to D-LX 720 installation, assembly, commissioning, operation, maintenance, malfunction diagnostics, repairs etc. |
| <b>Appendix 10 – 15</b> | Overview of technical data, standards and regulations to be complied with, spare parts list, certifications, glossary, index and company addresses.                           |

## 1.2 Typographical conventions

In order to make the text of this manual clear, text elements such as safety instructions, warnings, tips, keyboard symbols, menu addresses etc. are displayed differently.

The following conventions apply in this manual:

Safety instructions and warnings appear as follows in this manual:

### WARNING



#### Danger from electrical equipment

Before removing the housing or accidental-contact protection, the equipment must be disconnected from the power supply.

A note or tip is shown like this:



Rotary switches S1 to S8 do not have a stop. The switch can be turned from switch position F to switch position 0.



Explicitly identified paragraphs only refer to the specified device variant. All other information applies for both device variants.



- This DIP switch is OFF
- This DIP switch is ON
- A (→) indicates that the following term is explained in the glossary.
- Unless otherwise specified: all dimensions **in mm**
- This manual is also available as a pdf file on CD/DVD!

## 1.3 Meaning of the warnings and notes used

Please always comply with the following warnings and safety instructions in this manual. They serve to avert **dangers to life and limb** of users and maintenance personnel and to prevent damage to property.

They are highlighted in this manual by the signs defined here. They are also marked by symbols at the points where they appear. The signs used have the following meanings for the purposes of this manual and the information on the product itself:

### DANGER



Failure to comply with instructions highlighted in this way can result in severe and even fatal injuries.

Also means that substantial damage to property can occur, if the relevant precautions are not taken.

> Comply with all hazard warnings, in order to prevent injuries.

**WARNING**



Failure to comply with instructions highlighted in this way can result in serious injuries or damage to property.  
 > Comply with all warnings, in order to prevent injuries and to ensure safe operation of the system.

**CAUTION**



Failure to comply with instructions highlighted in this way can result in minor injuries or damage.  
 > Comply with all caution warnings, in order to prevent injuries and to ensure safe operation of the system.

In order to specify the potential risk the general warning sign can also be replaced by a special warning sign.

	General warning sign		Hot surface
	Electric current		explosive atmosphere
			Electrostatically endangered components (ESD)

In addition to the warnings and safety instructions, the following general notes and related pictograms are also used to draw your attention to particularly important information:



Here you will find interesting information or tips on the product and its use.



---

D-LX 200

D-LX 720

## Compact Flame Monitor



---

### **2 Safety Instructions**

- 2.1 General safety instructions
  - 2.2 Hazard from electrical equipment
  - 2.3 Hazard from hot, aggressive or explosive gases
  - 2.4 Hazard to the device due to purge air failure
  - 2.5 Proper use
  - 2.6 Prevention of consequential damages in the event of system malfunction
  - 2.7 Qualified personnel
-





## 2 Safety Instructions

Please always comply with the following warnings and safety instructions in this manual. They serve to avert **dangers to life and limb** of users and maintenance personnel and to prevent damage to property.

### 2.1 General safety instructions

The DURAG Compact Flame Monitor D-LX 200, D-LX 720 is in accordance with the current state of technology and the recognized technical safety regulations, nevertheless hazards can arise.

Therefore only operate the product in perfect condition and in compliance with the operating manual. Changes in the normal operation are indications of functional impairments which must be taken seriously. In this connection, pay attention to:

- The development of smoke or unusual odours,
- Excessive temperature of system parts,
- Unexplained changes in power consumption,
- Triggering of monitoring devices.

Improper use or handling can result in damage to health or property. Therefore, please read this chapter thoroughly and comply with the instructions during all activities on the D-LX 200, D-LX 720 as well as the safety instructions and warnings in the individual chapters of this operating manual.

In principle, the following warnings and safety instructions apply for the D-LX 200, D-LX 720:



The flame monitor is a type-approved device. Any interventions or modifications will result in loss of the approval. Repairs may only be performed by the manufacturer or his representatives, as only they can verify full functionality following repair, by means of extensive long-term tests and suitable test devices.

- The statutory provisions applicable for the system and the technical regulations implementing these provisions must be complied with during preparation and performance of work.
- Persons working with the system must take account of the local, system-specific conditions and operation-related dangers and provisions.
- Operating manuals and documentation belonging to the device D-LX 200, D-LX 720 must be present in-situ. The information highlighted therein for the prevention of dangers and damage must be complied with.
- Suitable protective devices and personal safety gear must be available in adequate quantities and be used by the personnel according to the respective danger potential.
- The device may only be operated in perfect condition and in compliance with the safety instructions!
- The devices as a whole, as well as the individual components, may only be operated in the original design.
- Any interventions or modifications to the design of approved devices will result in loss of the approval.

## 2.2 Hazard from electrical equipment

This device is operated with electricity. Therefore, only appropriately qualified personnel may carry out work on this device. These personnel must be thoroughly familiar with all danger sources and repair measures in accordance with these operating instructions.

### WARNING



#### Danger from electrical equipment

Before removing the housing or accidental-contact protection, the equipment must be disconnected from the power supply.

- The devices may only be connected to the supply voltage shown on the type plate.
- The devices may only be operated on a power supply with an earthing contact. The protective action must not be cancelled by an extension without an earthing contact. Any interruption in the protective earth conductor inside or outside the device is dangerous and is not permitted.
- Cables should be laid so that risk of accident due to tripping or getting caught on the lines is excluded.



We recommend a power supply that guarantees a safe separation between primary and secondary power circuits (e.g. DURAG D-NG 24/05).

### CAUTION



#### Damage to electronic components through electrostatic discharge (ESD)

Electronic components are becoming ever smaller and more complex. With this their susceptibility towards electrostatic discharges also increases. To protect these components, measures must be taken against electrostatic discharges (ESD protection) when performing any work on the open device.

For prevention of static charging of the human body, service employees can for example be equipped with a personal grounding system.

## 2.3 Hazard from hot, aggressive or explosive gases

### WARNING



Use of the Compact Flame Monitor D-LX 200, D-LX 720 in **potentially explosive areas** is only permitted with the appropriately **identified device variant**, which is designed for this environment! **The zone identification printed on the device must be noted.**

- The Compact Flame Monitor is mounted directly on the boiler. In the case of systems with a low danger potential (ambient pressure, low temperatures, no health hazard), mounting/removal can occur during system operation. The applicable provisions and safety regulations for the system must be complied with and any necessary and appropriate protective measures taken.

**WARNING**

Never touch parts that could be hot without temperature-resistant safety gloves

## 2.4 Hazard to the device due to purge air failure

**CAUTION**

The purge air serves to protect the system mounted on the boiler. It shields the components from hot and/or aggressive gases and dusts. The purge air supply must therefore be reliably ensured even when the system is stationary. If the purge air fails, the lens can quickly become soiled and the device can overheat due to heat accumulation and be destroyed.

The operator must therefore ensure that:

- the purge air supply operates reliably and without interruption,
- a failure is detected immediately,
- the Compact Flame Monitor is protected by a valve or disconnection in the event of a purge air failure.

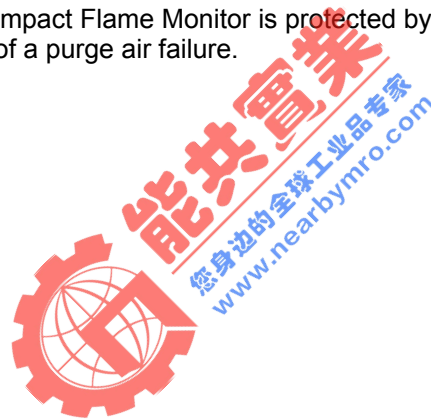

## 2.5 Proper use

---

The DURAG D-LX 200, D-LX 720 described in this manual is an Compact Flame Monitor for monitoring gas, oil, coal and wood flames.

The D-LX 200, D-LX 720 is used as a flame monitor, for example in large power stations through to smaller district heating plants, chemical process or thermal exhaust gas incineration plants, refineries etc.. This flame monitor is suitable for continuous operation and 72-hour operation in accordance with TRD 604. The device can monitor the flames of all fuels and incineration technologies, particularly for gas, oil, coal and wood, low-NOx, recirculating operation, Claus plants etc.

The parameters specified in the Technical Data from page 101, especially the ambient conditions, must be complied with and observed.

Faultless and safe operation of this device also requires appropriate transport, correct storage, installation and assembly as well as careful operation and maintenance by qualified personnel.



The D-LX 200, D-LX 720 has been developed, manufactured, inspected and documented in compliance with the pertinent safety standards. If the handling and safety instructions described for project planning, assembly, proper operation and maintenance are complied with, no dangers normally arise from the device in respect of damage to property or the health of people.

## 2.6 Prevention of consequential damages in the event of system malfunction

---

In order to prevent and limit faults that can directly or indirectly result in physical injuries or damage to property, the operator must ensure that:

- Competent maintenance personnel can be promptly notified and are available at all times.
- Maintenance personnel are trained in the targeted localisation and rectification of faults in the D-LX 200, D-LX 720 and associated systems.
- The defective system parts are shut down immediately if necessary.
- A shut-down does not lead to incalculable consequential malfunctions and damages.

## 2.7 Qualified personnel

---

The operator's personnel who are responsible for safety must ensure that work on DURAG equipment or systems is only carried out by qualified skilled personnel, whose competence has been checked by responsible experts.

In the event of unqualified operations on the device or failure to comply with the warnings provided in this manual or affixed to the device, physical injuries and/or damage to property can occur.

Qualified personnel for the purposes of the safety-related instructions in this manual or on the product itself are persons who can identify potential dangers in good time and prevent them. Skilled personnel/experts are persons in accordance with DIN VDE 0105 or IEC 364 or directly comparable standards.

The following knowledge is essential:

- Exact knowledge of operation-related dangers
- Knowledge of system conditions, pertinent standards, regulations and accident prevention regulations.
- Adequate knowledge of the system D-LX 200, D-LX 720. DURAG offers suitable training for this purpose.

On the basis of this training, qualified personnel are authorised by the person responsible for the safety of people and system to carry out work on DURAG equipment or systems,

- either as project planning personnel, are familiar with the safety concepts of automation technology,
- as operating personnel, are instructed in handling automation technology equipment and are familiar with the contents of this manual relating to operation,
- as repair and/or service personnel, have training that qualifies them to repair such automation technology equipment or have authorisation to commission, earth and identify circuits and devices/systems in accordance with the safety-related standards.



Burner controls and flame monitors are type-approved devices. Any interventions or modifications will result in loss of the approval.

The abovementioned qualifications and authorisations expressly do not apply for interventions or modifications to type-approved devices!

Repairs may therefore only be carried out by the manufacturer or his representatives. This is necessary to ensure that tests and measurements (with the requisite special devices and specialist knowledge) prescribed after repairs or other interventions can be performed.

Burner controls and flame monitors serve for the safe operation of a furnace plant. The reliability of these devices is essential, and requires particularly careful inspection of the relevant functions with a concluding acceptance test after interventions.



---

D-LX 200

D-LX 720

## Compact Flame Monitor

03

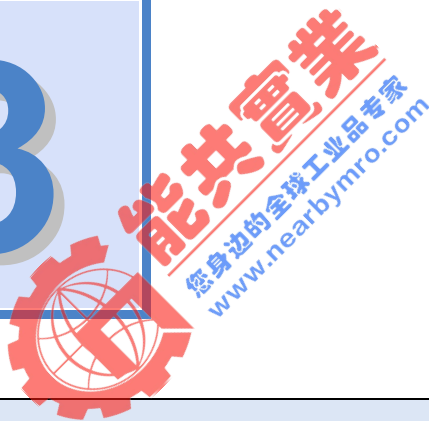

---

### **3 Product Description**

- 3.1 Notes on delivery
  - 3.2 Scope of supply / Design variants
  - 3.3 Special accessories (optional)
  - 3.4 Options
    - 3.4.1 Optional, factory settings
  - 3.5 Notes on the product
  - 3.6 Fields of application, intended use
  - 3.7 Selection criteria for Compact Flame Monitor D-LX 200, D-LX 720
  - 3.8 Conformity/Approvals
  - 3.9 Identification of the product
  - 3.10 Notes on warranty
-





### 3 Product Description

In this chapter you will find information on scope of supply, special accessories, approvals, warranty fields of application of the D-LX 200, D-LX 720.

#### 3.1 Notes on delivery

The Compact Flame Monitor D-LX 200, D-LX 720 is delivered in a packaged unit. It usually contains the products listed in point „Scope of supply“ on page 25.

The respective scope of delivery is listed according to the valid sales contract on the shipping documents enclosed with the shipment. Verify the shipment for completeness and undamaged condition.

All transport damages must be immediately reported to the shipping agent and the DURAG GROUP. For addresses see page 115 (DURAG GROUP company addresses).

#### 3.2 Scope of supply / Design variants

Scope of supply of the standard system D-LX 200, :D-LX 720

	<p><b>The following variants are available:</b></p> <p><b>D-LX 200 UA, D-LX 720 UA</b> Compact Flame Monitor with UV photo-diode (<math>\lambda = 190 \text{ nm}</math> to <math>520 \text{ nm}</math>)</p> <p><b>D-LX 200 UAF, D-LX 720 UAF</b> Compact Flame Monitor with UV photo-diode (<math>\lambda = 280 \text{ nm}</math> to <math>410 \text{ nm}</math>)</p> <p><b>D-LX 200 IG, D-LX 720 IG</b> Compact Flame Monitor with IR photo-diode (<math>\lambda = 780 \text{ nm}</math> to <math>1800 \text{ nm}</math>)</p> <p>(all devices have a 2 m connection cable prewired on the device side)</p>
	<p>Printed brief introduction and detailed manual on CD</p>

### 3.3 Special accessories (optional)

D-LX 200	D-LX 720	Picture	Order code
✓			<b>D-ZS 033 – I</b> Swivel mount with G 1 1/4 " threaded end fitting
✓			<b>D-ZS 133 – I</b> Ball-type valve with G 1 1/4 " threaded end fitting
✓	✓		<b>D-ZS 093</b> Combined test light source 230 V / 50 Hz for the UV-A, UV-B and IR range for checking the function
✓	✓		<b>D-NG 24/05</b> AC power supply 115 or 230 VAC, 50/60 Hz
✓	✓		<b>D-ZS 140-12</b> Junction box for flame sensor; IP 65; 12-pin
✓			<b>D-ZS 117 - I</b> Thermal insulator with potential isolation and G1 1/4 " threaded end fitting
✓			<b>D-ZS 118</b> Optical setting aid for aligning the swivel mount to the sighting tubes
✓	✓		<b>D-ZS 129 -30/-40</b> Bar graph display for displaying the flame intensity (19" system)
✓	✓		Connection cable x m (specify length)
✓	✓		Tropicalisation of printed circuit boards
✓	✓		Option: detailed, printed manual

## 3.4 Options

### 3.4.1 Optional, factory settings

The Compact Flame Monitor D-LX 200, D-LX 720 can be supplied with the options specified in the following table. The variant supplied as standard has a dark background. If other options are required, please specify when ordering the Compact Flame Monitor.

"Flame intensity" current output	0 - 20 mA		4 - 20 mA	
Safety time	1 sec.	2 sec	3 sec	5 sec.

Table 3.1: Default settings for D-LX 200, D-LX 720

## 3.5 Notes on the product



The Compact Flame Monitor D-LX 200, D-LX 720 is a safety device comprising control unit and integrated optical flame sensor in one housing. This integration saves time and cost for assembly and wiring in comparison with the design with separate flame sensor and flame monitor.

## 3.6 Fields of application, intended use

The flame monitor D-LX 200, D-LX 720 is used for monitoring combustion processes with the most diverse fuels and combustion technologies in

- intermittent operation,
- continuous operation and
- in 72-hour operation, in accordance with (→) TRD 604

Possible areas of application are:

- Large power stations
- District heating plants
- Chemical process incineration plants
- Thermal exhaust gas incineration plants
- Claus plants
- Rotary kilns
- Refineries etc.

The Compact Flame Monitor is suitable for all **fuels** and combustion technologies, particularly for:

- Gas
- Oil
- Coal
- Wood
- Low-NOx

- Recirculating operation
- Claus plants etc.

The parameters specified in the Technical data from page 101 must be complied with and observed. In particular, please note:

- Permissible ambient temperature: - 40°C to + 85°C
- Class of protection IP 68

### 3.7 Selection criteria for Compact Flame Monitor D-LX 200, D-LX 720

Defined prerequisites must be checked for use of the Compact Flame Monitor D-LX 200, D-LX 720. The suitability of the device can be quickly and simply established with the help of the following checklist.

Model	Spectral range [nm]	Suitable for fuels				Characteristics
		Gas	Oil	Coal	Wood	
D-LX 200 UA D-LX 720 UA	190 - 520	++	++	○		Monitoring of gas and oil flames, also for low-NOx incineration.
D-LX 200 UAF D-LX 720 UAF	280 - 410	+	++			Monitoring of very intensive gas and oil flames, also for low-NOx incineration.
D-LX 200 IG D-LX 720 IG	780 - 1800	○	+	++	++	Monitoring of oil and wood dust flames as well as coal flames.

Table 3.2: Suitability of device variants (spectral ranges)

Explanation of symbols:

- ++ The flame sensor is optimally suited for this fuel.
- + The flame sensor is well suited for this fuel.
- The flame sensor is **conditionally suited for this fuel**.  
The monitoring characteristics depend for the most part on the combustion technology.

This table is based on many years of experience at a multitude of furnace plants. However, a specific flame behaviour due to the combustion technologies used in the individual case cannot be taken into consideration. Deviations from this table are therefore possible.

### 3.8 Conformity/Approvals



The D-LX 200 D-LX 720 has been developed, manufactured, inspected and documented in compliance with the pertinent safety standards. If the handling and safety instructions described for project planning, assembly, proper operation and maintenance are complied with, no dangers normally arise from the device in respect of damage to property or the health of people.

In addition, the Compact Flame Monitor provides a high level of safety and availability, thanks to the use of two parallel-operating microprocessors with appropriate software and hardware. The device hardware is designed in accordance with the EC directive on electromagnetic compatibility (EMC), so that it conforms to the EMC law.

The D-LX 200, D-LX 720 is available with different approvals. An overview is provided in the following table:

D-LX 200 ... D-LX 720 ...	CE	SIL IEC 61508	C SP US	FM APPROVED
-10	✓			
-20	✓	✓		
-30			*	*
-40		✓	*	*

\*under preparation

**Table 3.3: Device approvals**

The declaration of conformity can be found in the Appendix from page 107.



### 3.9 Identification of the product

The type plate is located on the lower side of the housing.



### 3.10 Notes on warranty

Please note that the contents of this device manual are not part of nor intended to modify a previous or existing agreement, undertaking or legal relationship. The warranty for equipment from the DURAG GROUP is generally 12 months from the date of delivery. All obligations result from the respective purchase contract, which also contains the complete and solely valid warranty regulation. These contractual warranty terms are neither extended nor limited by the comments in this document.

Modifications and alterations to the Compact Flame Monitor are not permitted. Any interventions on the device will result in termination of the warranty. As burner controls and flame monitors are type-approved devices, any interventions or modifications to them will result in **loss of the approval**.

Faultless and safe operation of this device also requires appropriate transport, correct storage, installation and assembly as well as careful operation.



A high level of reliability is expected from safety-relevant components like Compact Flame Monitors. Careful maintenance is a basic prerequisite for safe operation. This is essential to ensure that functional irregularities are detected and rectified at an early stage.

Approx. 10 years after commissioning at the latest ( $\triangleq$  250,000 cycles; see also EN 298 and EN 230) with typical use and environment of the D-LX 200, D-LX 720, **the tests and maintenance measures specified for the product by the manufacturer** must be performed by the manufacturer or his representative. These measures can also result in replacement of the product.

---

D-LX 200

D-LX 720

## Compact Flame Monitor



---

### 4 Design and Function

- 4.1 Functional description
  - 4.1.1 Ultraviolet flame sensor
  - 4.1.2 Infrared flame sensor
  - 4.1.3 Self-monitoring
  - 4.1.4 Error shutdown
- 4.2 Device description





## 4 Design and Function

This chapter explains the mode of operation of the Compact Flame Monitor and the interaction of the components involved.

### 4.1 Functional description

The Compact Flame Monitor D-LX 200, D-LX 720 comprises an optical flame sensor and a control unit in one housing. The flame sensor converts the light signal of the flame into an electrical signal, while the control unit ensures self-monitoring, evaluates the flame signal and communicates the result.

The operator must provide the necessary purge air to protect the optics from dust and / or hot gases, and the power supply.

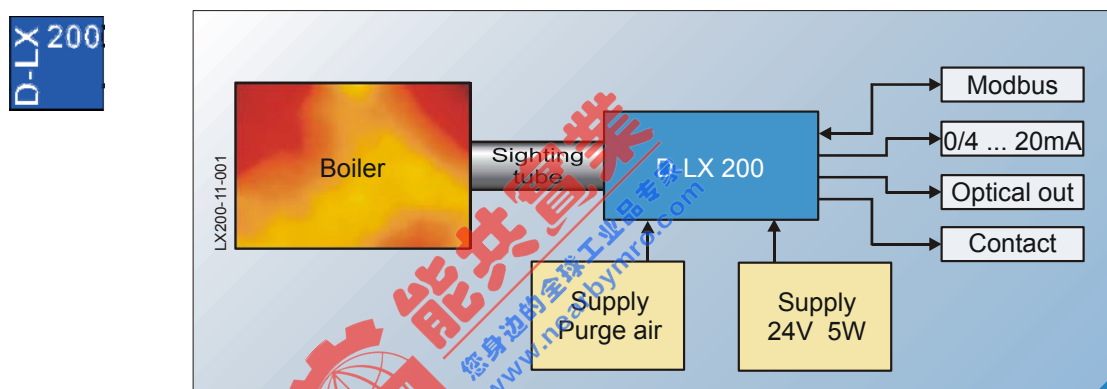

Figure 4.1: System overview D-LX 200

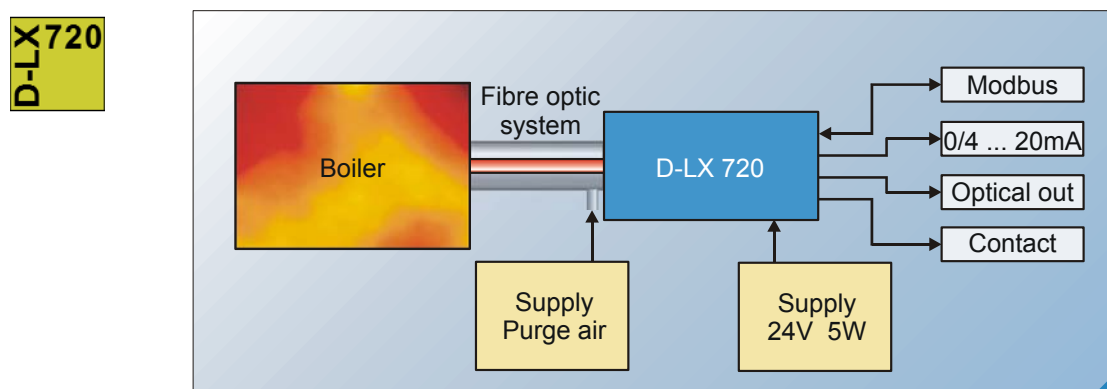

Figure 4.2: System overview D-LX 720

The flame monitor D-LX 200, D-LX 720 is available with semiconductor photo-diodes for the band of radiation in the shortwave ultraviolet (UV) or infrared range (IR).

The photo-diodes used in the flame sensor evaluate different spectral ranges of the flame, depending on the version. The signal from the photo-diodes

passes through a two-channel (Chan. 1 and Chan. 2) microcontroller-adjustable amplifier with filter stages. Both the static and the dynamic portion of the flame radiation are available for evaluation at the output. The range selection enables switching of the flame monitor settings to another parameter set (intensity and frequency switching threshold, current gain characteristic).

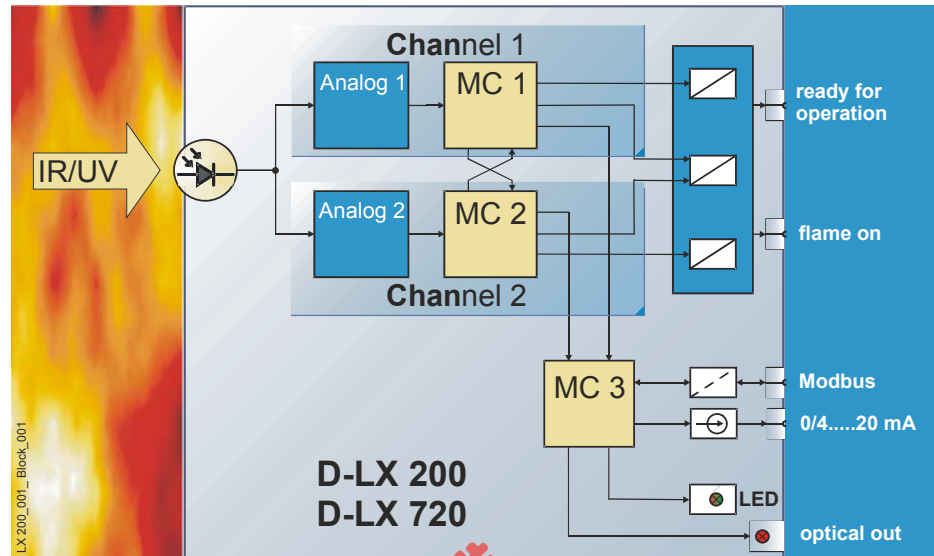

Figure 4.3: Block diagram

In both microcontrollers for control and monitoring of the safety-relevant flame monitor functions and self-monitoring, both the static and the dynamic flame signals, depending on the set switching threshold (frequency, intensity), are evaluated for the Flame ON or Flame OFF signal.

Two relay contacts connected in series and a green LED in the front panel are available for the flame signal. The intensity of the flame signal can also be displayed using a field bus, an optical data bus and a 0/4 .. 20mA current output.

Readiness for operation or malfunction is indicated by a contact of the dynamically controlled fault relay, with monitoring of the internal operating voltages and all safety-relevant hardware functions, and LEDs in the front panel.

A single-channel microcontroller controls the non-safety relevant input and output functions.

The internal power unit transforms electrically isolated from 24V to 12V/3.3V.

### 4.1.1 Ultraviolet flame sensor

The UV radiation zone of a flame is generally much smaller than the IR zone. In addition, internal components or boiler walls do not emit any dynamic UV radiation. UV flame monitors are therefore very selective, i.e. insensitive to background radiation.

In the D-LX 200 UA, D-LX 720 UA a photo-diode with a spectral sensitivity of  $\lambda = 190 \text{ nm}$  to  $520 \text{ nm}$  is used. The integrated flame sensor therefore records the dynamic blue to transparent band of radiation, e.g. of gas, oil and coal flames, without suffering significant signal interruptions due to water vapour, recirculation gas or similar UV-absorbing gases.

In the D-LX 200 UAF, D-LX 720 UAF the photo-diode of the D-LX 200 UA, D-LX 720 UA is used, with an optical filter. The filtering results in a limited

spectral range of  $\lambda = 280 \text{ nm}$  to  $410 \text{ nm}$ , which provides better results in the case of very intensive UV radiation or higher selectivity requirements.



The filter is opaque in the visible spectral range, and therefore appears black to the human eye. The photo-diode is visible through the lens of the flame monitor.

#### 4.1.2 Infrared flame sensor

The IR radiation zone of a flame is extensive in many cases and very intensive relative to the UV radiation. The IR zone is therefore easy to detect from different viewing angles, emits a strong signal and is unsusceptible to absorption by gases. On the other hand, there is a higher background radiation sensitivity in comparison with a UV flame sensor.

If a flame glows yellow or red, then it is "visible" to this flame monitor. However, the prerequisite here too is movement (dynamics) in the flame.

In the D-LX 200 IG, D-LX 720 IG an InGaAs photo-diode with a spectral sensitivity of  $\lambda = 780 \text{ nm}$  to  $1800 \text{ nm}$  is used. The integrated flame sensor thus detects the dynamic band of radiation, which is generated by almost all fuels. This flame monitor emits a strong signal, but because of the extensive IR radiation zone presents a lower selectivity.

Flames whose shortwave UV radiation is absorbed by dust, water vapour or other substances, can be monitored in the infrared range. Typical applications are waste incineration plants and wood-fired furnaces.

With regard to measures for  $\text{NO}_x$  reduction in incineration plants, such as e.g. exhaust gas recirculation or plants with combined burners for gas and oil, IR flame sensors with a spectral sensitivity up to  $1800 \text{ nm}$  have particularly proven themselves for flame monitoring.



It can occur in practice that static emitters, such as e.g. glowing boiler components, are modulated by combustion air currents or flue gas plumes, and act as ambient light with dynamic radiation components. If this radiation lies in the range picked up by the monitor, i.e. in the IR spectrum and in the normal flicker frequency range (approx.  $10$  to  $200 \text{ Hz}$ ) of a flame, then an output signal corresponding to the intensity and dynamics of the received radiation is generated by the flame monitor. The switching threshold of the D-LX 200, D-LX 720 must not be exceeded by this background radiation and must never result in a Flame ON signal (see chapter 6.1 Adjusting the thresholds on page 54).

#### 4.1.3 Self-monitoring

The Compact Flame Monitor D-LX 200, D-LX 720 with integrated flame sensor is a failsafe flame monitor with self-monitoring. After switching on the power supply, the flame monitor performs a self check, which is constantly repeated during subsequent continuous operation.

In continuous operation, any component failure that affects safety-relevant functions triggers an error shutdown. The flame monitor D-LX 200, D-LX 720 is equipped with a dual-channel microcontroller system (Chan. 1 and Chan. 2), which controls all functions and self-checks and monitors all safety-relevant timing sequences. The input and output states are independently checked and compared by the two microcontrollers. Only if they agree is operation continued.

The throughout dual-channel design (see Figure 4.3: Block diagram on page 34) allows the elimination of regular interruption of the photoelectric current (shuttering) and mechanical wearing parts.

#### 4.1.4 Error shutdown

If an error is detected in the safety-relevant software and hardware components during internal self-monitoring of the flame monitor, an error shutdown and internal lockout must be triggered. The relays of the flame signal and readiness for operation signal drop out and the Fault (Error) LED in the front panel illuminates, while the Power LED starts to flash (for meaning of LEDs see page 40).

Actuation of the internal reset key (behind the front panel of the D-LX 200, D-LX 720) acknowledges an error shutdown and enables restarting of the flame monitor. Actuation of an external reset key also acknowledges an error shutdown and enables restarting, but the flame monitor must be in the error position for this purpose. A reset can also be performed by temporarily removing the power supply.

All LEDs go out when the reset key is pressed.

Irrespective of the device status (flame signal ON / OFF or fault), the relays drop out after a mains break or actuation of the reset key, and the flame monitor program restarts.

## 4.2 Device description

The housing of the Compact Flame Monitor D-LX 200, D-LX 720 comprises a break-proof, coloured, temperature and chemical resistant plastic material (polyamide PA 66). It contains the control unit and the integrated optical flame sensor.

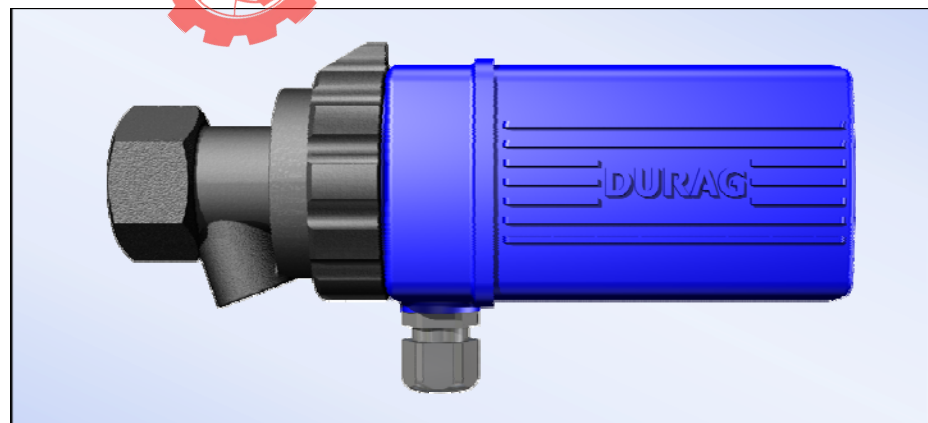

Figure 4.4: D-LX 200

The features of the Compact Flame Monitor include:

- Consistent dual-channel microcontroller system (Chan. 1 and Chan. 2) for control and monitoring of the safety-relevant flame monitor functions with continuous self-monitoring,

- Switching for the range selection which enables switching of the flame monitor to another parameter set (intensity and frequency switching threshold, gain characteristic),
- 8 selectable current gain characteristic curves per range,
- Switchable highpass filter for adaptation to the combustion conditions,
- A dynamically controlled fault relay with monitoring of the internal operating voltages and all safety-relevant hardware functions (see Figure 4.3: Block diagram on page 34),
- Flame relay with self-monitoring circuit,
- Incrementally adjustable thresholds for intensity and flame flicker frequency (16 stages),
- A single-channel microcontroller for control of the non-safety relevant input and output functions,
- LED display for indicating operational readiness of the active range, flame signal or flame monitor fault,
- Analogue output 0/4...20 mA for external display of the flame intensity

Selective individual burner monitoring or combustion chamber monitoring can be achieved by selecting a suitable flame monitor type, positioning the sighting tube appropriately and adjusting the sensitivity.

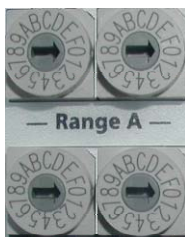

All customer connection terminals are prewired in the device and are brought out on the connection cable (customer wiring).

The thresholds for the flame signal of the compact flame monitor can be adjusted in 16 stages with rotary switches on the device.

The safety time or response time in the event of flame outage is set to 1 second in the factory. Longer safety times, e.g. 2s, 3s or 5s can be set at customer request.



D-LX 200

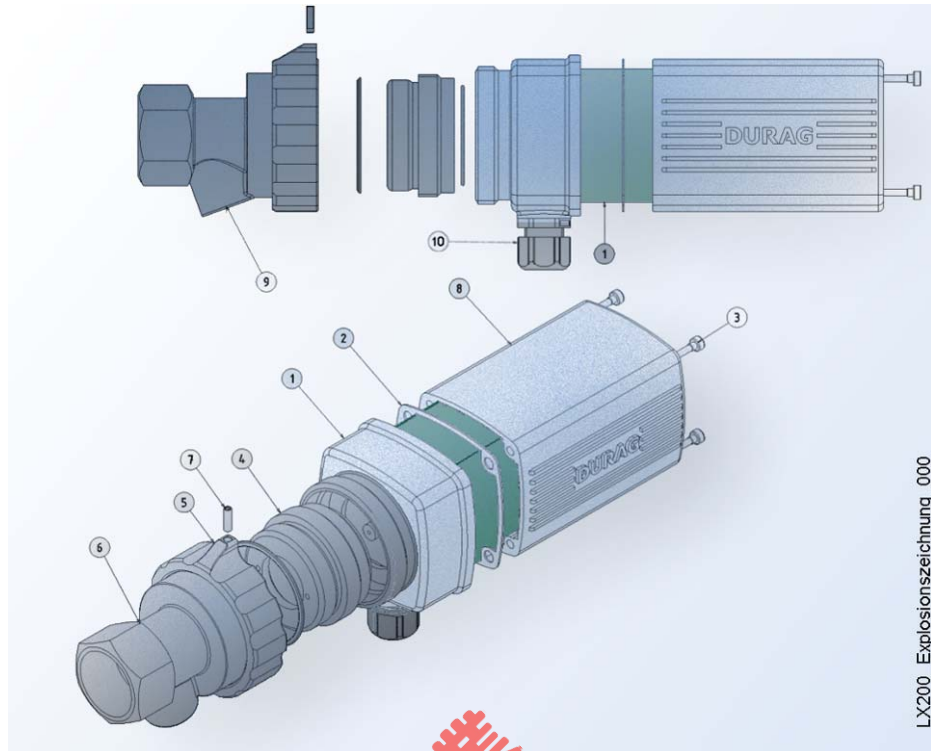

LX200\_Explosionszeichnung\_000

Pos	Description
1	Housing front part with printed circuit boards
2	Gasket
3	Screw M4 x 130
4	Lens insert module
5	Connection nut D-LE 103/603
6	Front part thread G 1 1/4", <i>optional: (-&gt;) NPT 1 1/4" female</i>
7	M4 Safety screw
8	Hood
9	Purge air connection thread G 1/2", <i>optional: (-&gt;) NPT 1/2" female</i>
10	Cable gland for connection cable

Figure 4.5: Exploded drawing D-LX 200

D-LX 720

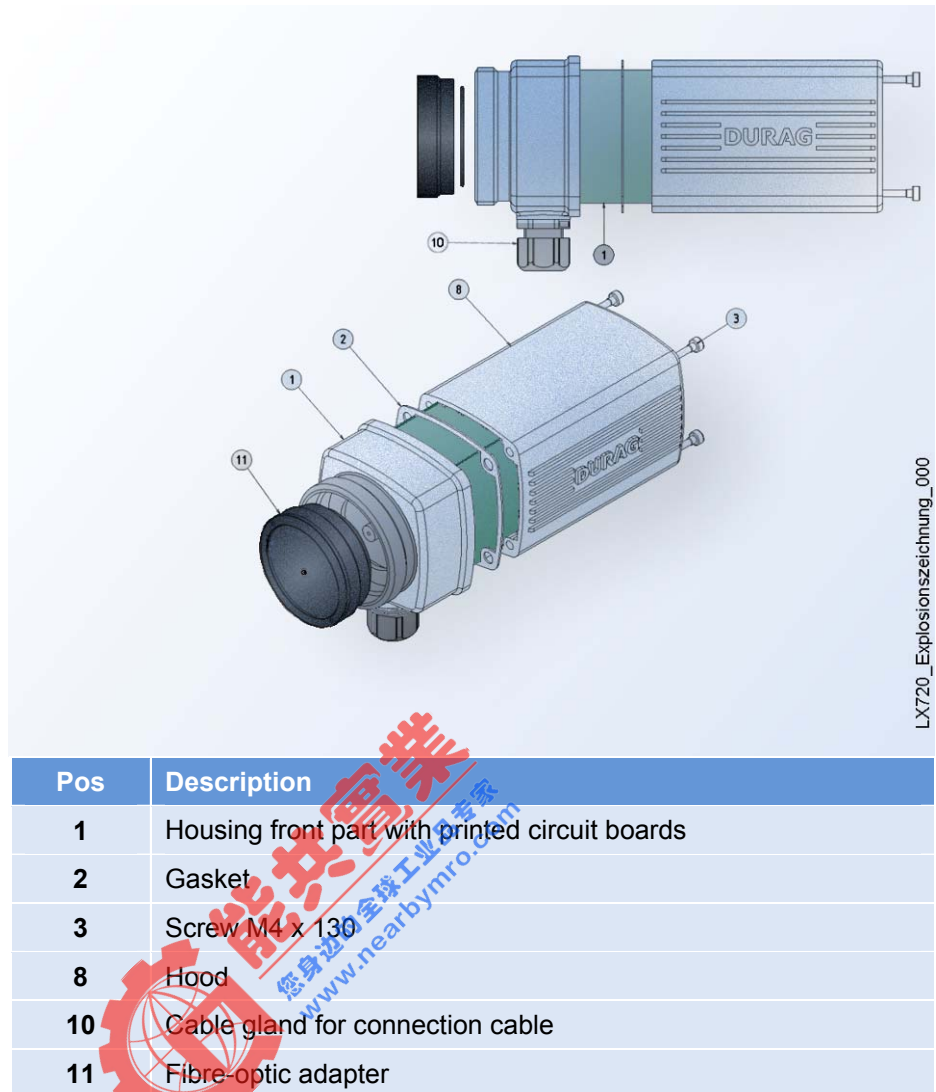

Figure 4.6: Exploded drawing D-LX 720

The display LEDs in the inspection window on the back of the device have the following meanings:

	①	<b>Intensity</b> (green) The flame intensity exceeds the set threshold for intensity.
	②	<b>Switch Error</b> (red) For at least one of the settable parameters, the switch setting for Chan. 1 and Chan. 2 is different. The different setting results in an error shutdown after 8s.
	③	<b>Frequency</b> (green) The flame flicker frequency exceeds the set threshold for the flicker frequency.
	④	<b>Range B</b> (yellow) Range B is active.
	⑤	<b>Flame</b> (green) The D-LX 200, D-LX 720 detects a flame.
	⑥	<b>Error</b> (red) An error has occurred.
	⑦	<b>Power</b> (yellow) The device is ready for operation.

Table 4.1: Meaning of the LEDs



能共管理  
您身边的全球工业专家  
www.nearbym.com

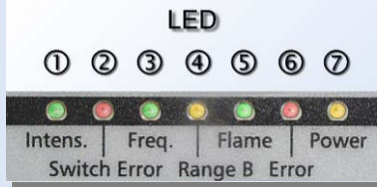

---

D-LX 200

D-LX 720

## Compact Flame Monitor

05



能共實業  
您身边的全球工业品专家  
www.nearbymro.com

---

### **5 Installation, Commissioning**

- 5.1 Safety
  - 5.2 Transport
  - 5.3 Installation
    - 5.3.1 Instructions on selecting a suitable installation point
    - 5.3.2 Mounting the flange
    - 5.3.3 Electrical connection
    - 5.3.4 Cables and shielding
    - 5.3.5 Installation, purge air supply
  - 5.4 Commissioning
-



## 5 Installation, Commissioning

In this chapter we explain points that must be noted during installation of the Compact Flame Monitor and how to connect purge air and electronics.

### 5.1 Safety

#### WARNING



#### Danger of electric shock

Once the housing or accidental-contact protection have been removed, live parts are accessible. Before working on the device, the mains connection leads must therefore be disconnected from the power and protected against unauthorized re-activation. If the accidental contact protection is removed, it must be replaced before switching on the mains voltage. Only appropriately qualified and trained personnel may carry out work on this device. These personnel must be thoroughly familiar with all danger sources and repair measures in accordance with these operating instructions. Flame monitors are type-approved devices; any interventions or modifications to them will result in loss of the approval.

#### WARNING



Use of the Compact Flame Monitor D-LX 200, D-LX 720 in **potentially explosive areas** is only permitted with the appropriately **identified device variant**, which is designed for this environment! **The zone identification printed on the device must be noted.**

#### CAUTION



In furnace plants with harmful gases, high gas temperatures or high pressure, the Compact Flame Monitor may only be mounted or demounted during downtime of the plant, unless using a shut-off ball-type valve!

The purge air supply must therefore be reliably ensured even when the plant is down. The purge air serves to protect the system mounted to the burner. The purge air shields components from hot and/or aggressive gases and dusts. If the purge air fails, the lens can quickly become soiled and the device can overheat due to heat accumulation and be destroyed.



#### Damage to property by unauthorised personnel

The person responsible for safety must ensure that only qualified (authorised) personnel operate the monitoring system described in this Manual.

Particular care must be taken to ensure that the warnings on operator protection and monitoring system protection specified in this Manual are known and adhered to.

#### CAUTION



#### Damage to electronic components through electrostatic discharge (ESD)

DURAG devices are protected from uncontrolled electrostatic discharge (ESD) during closed operation. If the device is opened (e.g. for service or maintenance works), then suitable ESD protective measures must be undertaken beforehand.

See also "Qualified personnel" on page 20.

The technical documents necessary for commissioning can be found on the following pages. The technical data can be found in the Appendix from page 101.

## 5.2 Transport

Avoid rough impacts. Use the original packaging for transport where possible: The mouldings used in it ensure safe transport.

## 5.3 Installation

### 5.3.1 Instructions on selecting a suitable installation point

The correct viewing position must be determined in order to guarantee optimal and selective flame monitoring. This must ensure that the flame is easily visible for the flame monitor in all load ranges of the burner and, if possible, that there are no flames from adjacent burners in the monitoring axis.

The D-LX 200, D-LX 720 has an angle of view of approx. 6°. This should always be oriented towards the root of the flame (ignition point of the flame), i.e. the first third of the flame.

### 5.3.2 Mounting the flange

The D-LX 200 is mounted on a sighting tube with a G1¼" male thread connection.

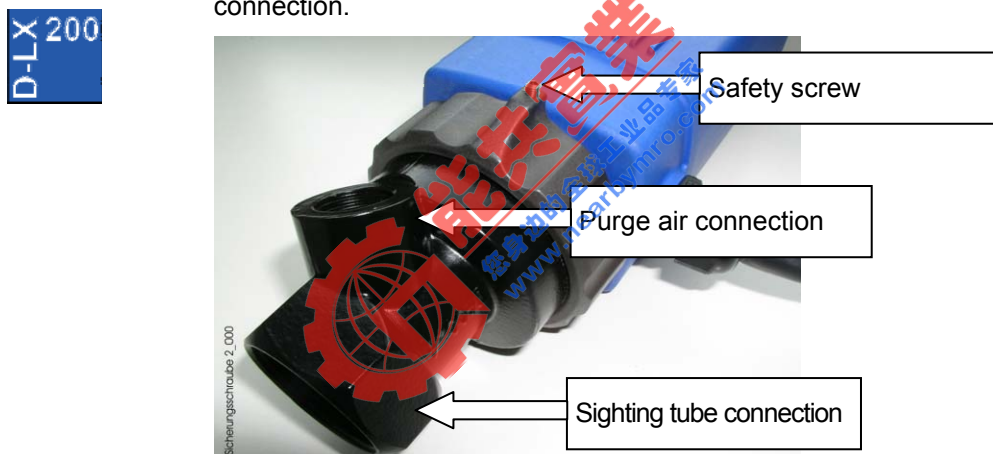

**Figure 5.1: Safety screw**

First of all, fasten the (black) front part of the Compact Flame Monitor with the purge air connection to the sighting tube.

The (blue) device part can then be tightened on it by hand with the connecting nut located on the front part.

The flame monitor should be routinely checked to ensure that the optics are clean and that the monitor is firmly mounted in the front part.

The connecting nut is provided with fastening protection by a safety screw (2 mm Allen key). Ensure that the flame monitor has been mounted correctly and that the safety screw is tight.

Various swivel mounts in series D-ZS 033 are available for optimising alignment with the flame (see Figure 5.2).



Dimensional drawing of swivel mount D-ZS 033-I

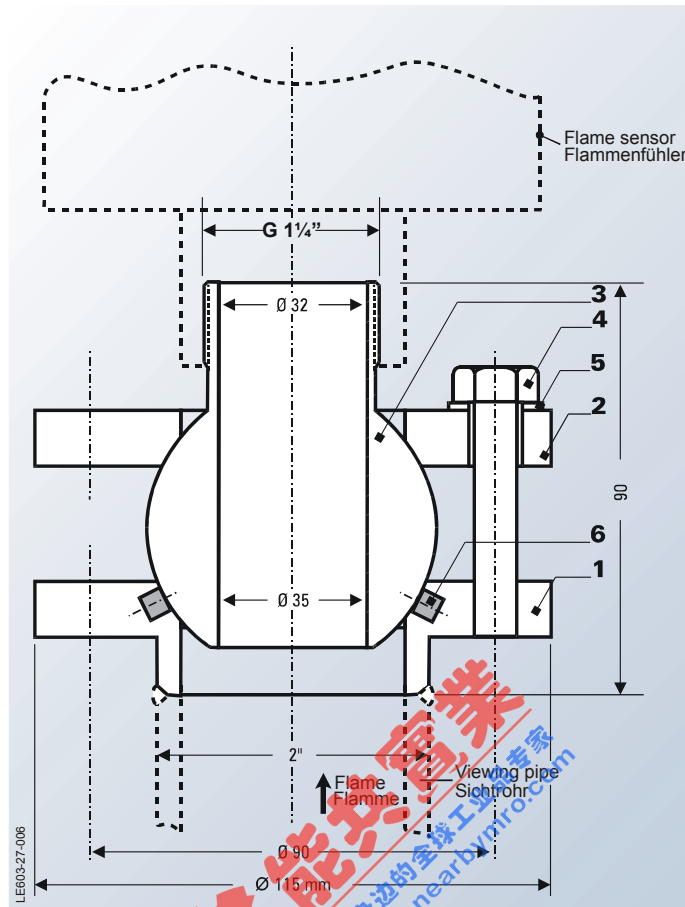

Figure 5.2: Dimensional drawing of swivel mount (optional for D-LX 200) D-ZS 033-I

Legend:

Pos.	Quantity	Designation	Material
1	1	Welding flange	1.0718, galvanised surface
2	1	Flange	Aluminium, alloy 230
3	1	Ball joint	Aluminium, alloy 230
4	3	Hexagon bolt	M10x60 DIN 558
5	3	Plain washer	10.5 DIN 125
6	1	Gasket	Graphite tape, asbestos-free

**CAUTION**



The purge air supply must be reliably ensured when mounting the D-LX 200 to the sighting tube, if necessary. The purge air serves to protect the system mounted on the boiler. The purge air shields components from hot and/or aggressive gases and dusts. If the purge air fails, the lens can quickly become soiled and the device can overheat due to heat accumulation and be destroyed.

### 5.3.3 Electrical connection

Installation occurs in accordance with the dimensional drawing of the Compact Flame Monitor D-LX 200, D-LX 720 (see Figure 11.2 page 104, and Figure 11.3 Page 105). The electrical installation is performed in compliance with the customary local regulations and the wiring diagram.

The class of protection of the flame monitor complies with IP 68. This protection only exists if the housing cover is fitted. Operation of the Compact Flame Monitor when open is not permitted.

The Compact Flame Monitor can bridge power failures for up to 20ms.

The location of fuses F1 and F2 is visible from Figure 5.3.



The fuse F2 protects the relay for Flame ON indication. Should an exchange of this fuse become necessary it is mandatory that the correct operation of the relay is checked before further use of the Compact Flame Monitor.

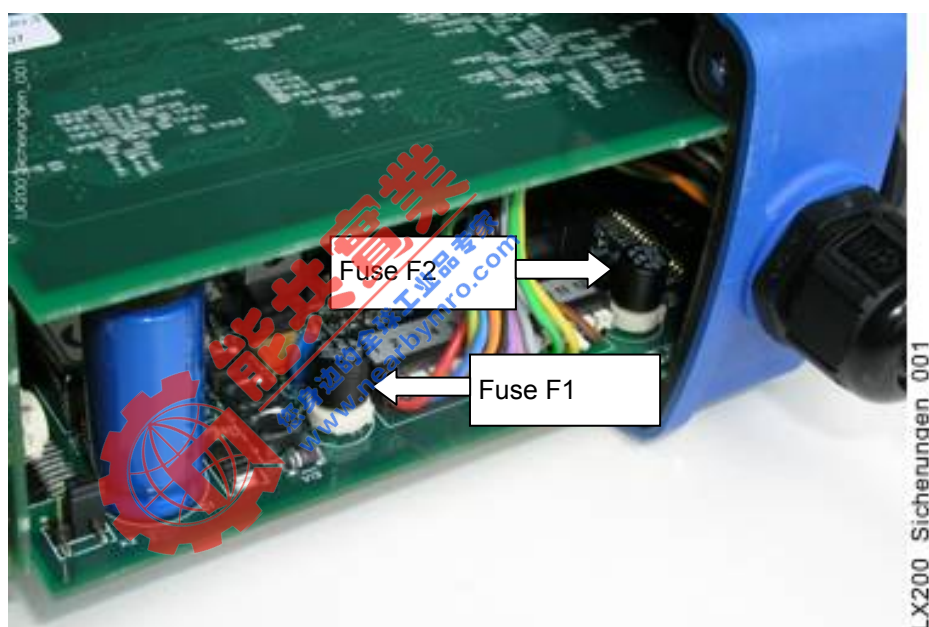

Fuses MST 250  
F1 (left) = 0.5 A slow-blow, F2 (right) = 0.5 A slow-blow

**Figure 5.3: Location of the fuses**



The housing cover must be removed in order to adjust the thresholds, the gain characteristic and the filter, and to replace fuses (switch off operating voltage beforehand). When fitting the housing cover back on, make sure that the printed circuit boards slide correctly into the guide rails and that the connection lines are not pinched.

In order to exclude possible disturbances due to transient currents on the protective conductor (e.g. currents from an ignition device to protective conductor potential), DURAG D-ZS 117-I insulators can be inserted between the sighting tube and the flame monitor. In this case the tube or hose line for the purge air connection of the flame monitor must also comprise non-conductive material.



Once mounted and connected in accordance with the dimensional drawings and wiring diagram, the D-LX 200, D-LX 720 compact flame monitor is ready for operation as soon as the mains voltage is switched on.

The connection cable is wired inside the device housing at the factory. The connections can be finished as shown in the following diagram.

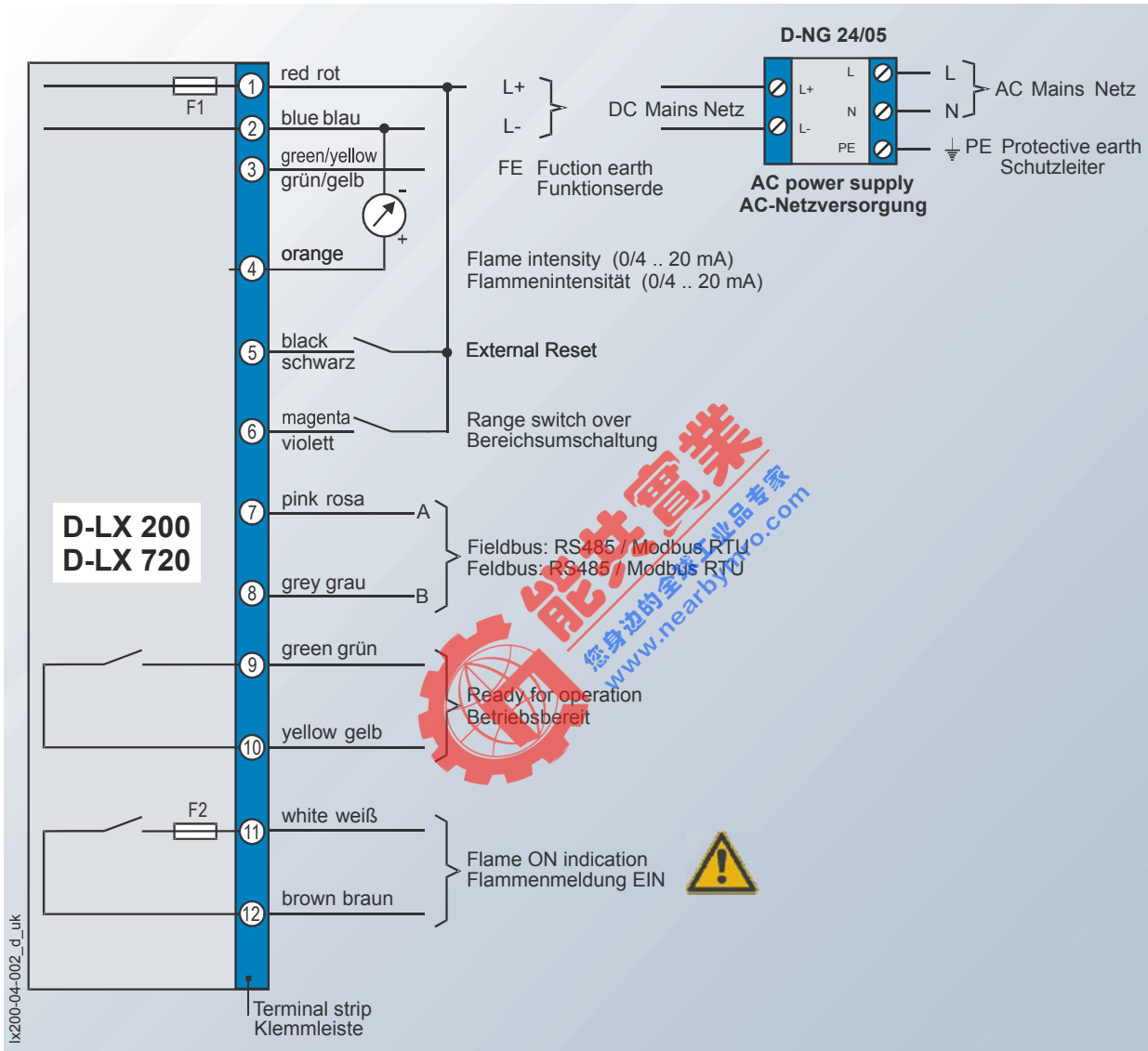

Figure 5.4: Wiring diagram D-LX 200, D-LX 720

### 5.3.4 Cables and shielding

The Compact Flame Monitor D-LX 200, D-LX 720 is designed for switching 24VDC voltages via the operation readiness contact and the flame contact. The contacts can generate sparks when switching a load, which, in the case of long line lengths, can affect other switching circuits.

It is advisable to install a junction box near the flame monitor and to execute the subsequent cabling with separate, shielded lines.

Over short distances (< 5m) the lines are unsusceptible to interference and do not need to be protected.

The single wires can be defined according to the system-specific requirements. The cross-section for the 24 V DC supply line must be large enough to ensure that  $R = 10 \Omega$  per wire is not exceeded. The D-LX 200, D-LX 720 flame monitor will then still operate reliably at

$$24V - (200mA \times 2 \times 10\Omega) = 20V$$

The D-LX 200, D-LX 720 has an electrically isolated design. There is no connection between the 24V DC supply voltage and the internal voltage of the flame monitor. If faults occur after installation, the cause can be a ripple voltage between the 0V potential of the supply and the internal operating voltage.

This can be remedied with a capacitive coupling C1= approx. 100nF or by eliminating the electrical isolation with a bridge B1.

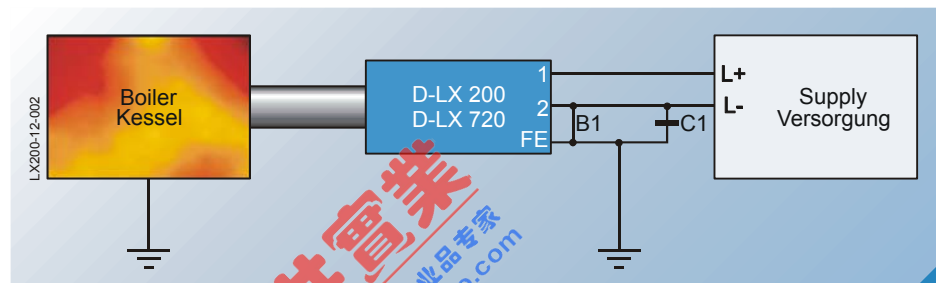

Figure 5.5: Elimination of the potential isolation

### 5.3.5 Installation, purge air supply



The purge air connection of the Compact Flame Monitor is responsible for keeping the sighting tube and the optics free of particles from the combustion chamber. A current of air, strong enough to blow away heavy particles, must therefore be aimed toward the combustion chamber. In applications with low particle levels, like gas burners, air velocities of  $v = 1 \text{ m/s}$  will sufficiently purge the air in a 1¼" sighting tube (air consumption approx. 3m³/h). Applications with higher levels, like coal-fired burners, require more purge air (air velocity  $v = 3 \text{ m/s}$ ). These velocities for the purge air in the sighting tube can only be a guide value and must be adapted to the specific system. A 1/2" screw connection with female thread provides the purge air connection on the flame monitor.

The flame monitor should be routinely checked to ensure that the optics are clean and that the monitor is firmly mounted in the front part.

If flame monitors must be mounted to sighting tubes with high temperature exposure, the purge air also serves for cooling. In such cases it is advisable to use thermal insulator D-ZS 117 I (see page 26) between flame monitor and sighting tube. However, you must always ensure that the Compact Flame Monitor does not exceed the maximum operating temperature of +85°C.

If there is an over-pressure on the sighting tube of the Compact Flame Monitor, we recommend installing ball-type valve D-ZS 133 I (see page 26) between flame monitor and sighting tube. If the optical system is soiled, cleaning can then be safely carried out after closing the ball-type valve.



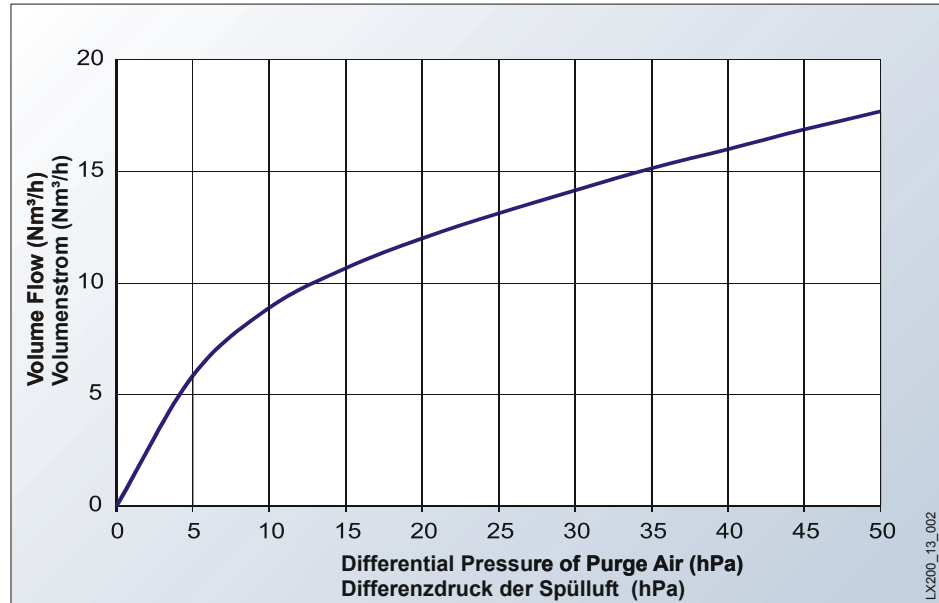

**Figure 5.6: Volume flow depending on the purge air**

If necessary, the purge air supply must be reliably ensured even during downtime of the plant. Failure of the purge air supply may not only result in soiling of the lens of the D-LX 200, D-LX 720 due to an accumulation of heat, but the device itself may also be affected.

The operator must therefore ensure that:

- the purge air supply operates reliably and without interruption,
- a failure is detected immediately.

Connect the D-LX 200, D-LX 720 and the purge air together. To do this, fix the hose to the provided purge air connection with the 1/2" female thread on the pipe screwed joint.



Purge air connection 1/2" screw connection with female thread  
Commissioning

**Figure 5.7: Purge air connection**

**D-LX 720**

If using a fibre-optic system, the purge air supply of the D-LX 720 is provided via the fibre-optic supply. Information on its assembly and installation can be found in the description of the optional fibre-optic system D-LL 703/704.

## 5.4 Commissioning

### Are the requirements for operation fulfilled?

<input type="checkbox"/>	Is the Compact Flame Monitor mounted in accordance with the dimensional drawings and wiring diagram, and is the fastening protection safety screw correctly tightened? (see page 44)
<input type="checkbox"/>	Is the power supply installed and switched on? (see page 46)
<input type="checkbox"/>	Has the cabling work been carried out as described from chapter 5.3.3 Electrical connection on page 46 ff.?
<input type="checkbox"/>	Is the purge air connected and operational? (see page 44)
<input type="checkbox"/>	Have the settings in the device been made correctly, as described in chapter 6 Adjusting the Flame Monitor on page 53 ff?

Table 5.1: Requirements for operation checklist

**CAUTION**



**Damage to property by unauthorised personnel**

The person responsible for safety must ensure that only qualified (authorised) personnel operate the system described in this Manual. Particular care must be taken to ensure that the warnings on operator protection and system protection specified in this Manual are known and adhered to.

The purge air serves to protect the system mounted on the boiler. The purge air shields components from hot and/or aggressive gases and dusts. If the purge air fails, the lens can quickly become soiled and the device can overheat due to heat accumulation and be destroyed.

The purge air supply must therefore be reliably ensured even during downtime of the plant.

**CAUTION**



**Damage to electronic components through electrostatic discharge (ESD)**

DURAG devices are protected from uncontrolled electrostatic discharge (ESD) during closed operation. If the device is opened (e.g. for service or maintenance works), then suitable ESD protective measures must be undertaken beforehand.

---

D-LX 200

D-LX 720

## Compact Flame Monitor



---

### **6 Adjusting the Flame Monitor**

- 6.1 Adjusting the thresholds
- 6.2 Setting the gain characteristic curve
- 6.3 Range selection
- 6.4 Setting the Modbus address
- 6.5 Setting process
  - 6.5.1 Setting by means of current output/LED
  - 6.5.2 Setting by means of D-LX 200 InformationCentre
- 6.6 Safety time



## 6 Adjusting the Flame Monitor

In this chapter we will explain how to use the D-LX 200, D-LX 720. We will explain the setting options for different switches and provide information on settings that must be made before commissioning to enable sensible use of the system.

In order to make the required settings with the necessary sensitivity, we recommend using the evaluation software D-LX 200 InformationCentre. This will enable you to read out the current system measuring data in real time on PC or Notebook and make the effects of the settings you have made visible immediately.

You can find information on the evaluation software in chapter 7 from page 69.

If you have any further questions on the evaluation software, please use our Support & Service. The addresses and telephone numbers for your DURAG GmbH representative can be found on page 115 (DURAG GROUP company addresses).

### WARNING



#### Danger from electrical equipment

If electrical protection is not guaranteed in the system by protective extra-low voltage (PELV), the flame monitor must be disconnected from the power source BEFORE removing the hood. Even if PELV is present, we recommend making the settings with the flame monitor disconnected from the power source, in order to prevent damage to equipment.

### CAUTION



#### Damage to electronic components through electrostatic discharge (ESD)

DURAG devices are protected from uncontrolled electrostatic discharge (ESD) during closed operation. If the device is opened (e.g. for service or maintenance works), then suitable ESD protective measures must be undertaken beforehand.



If the printed circuit boards have become loose after removing the hood, you must ensure that the plug connectors on the printed circuit boards are not misaligned when reassembled. This could result in severe damage to the D-LX 200, D-LX 720.

In order to guarantee failsafety, the flame monitor has a consistent dual-channel design. The two microprocessor systems control all functions and self-checks, and monitor all safety-relevant timing sequences. The input and output states are independently checked and compared by the two processors. Only if they agree is operation continued.

The switches described below are provided separately for each channel, i.e. they are present twice (designated Chan. 1 and Chan. 2 below). This ensures that the self-checks also detect abnormal behaviour or a defect in the switch and trigger an error shutdown. Therefore, if changes are made to the setting both switches must always (simultaneously, within 8s) be switched and moved to the same position.

The D-LX 200, D-LX 720 has thresholds for the intensity (Intens.) and flame flicker frequency (Freq.). The thresholds are operated by means of rotary switches.

For ideal adaptation of the Compact Flame Monitor to the local combustion conditions, different gain characteristics can also be selected for automatic current gain adaptation by means of (→) DIP switches.

The switches for the intensity (Intens.) and flame flicker frequency (Freq.) are located on printed circuit board no.3, and the DIP switches for selecting the gain characteristic are located on printed circuit board no.2.

The designations of the printed circuit boards can be seen in Figure 6.1 .

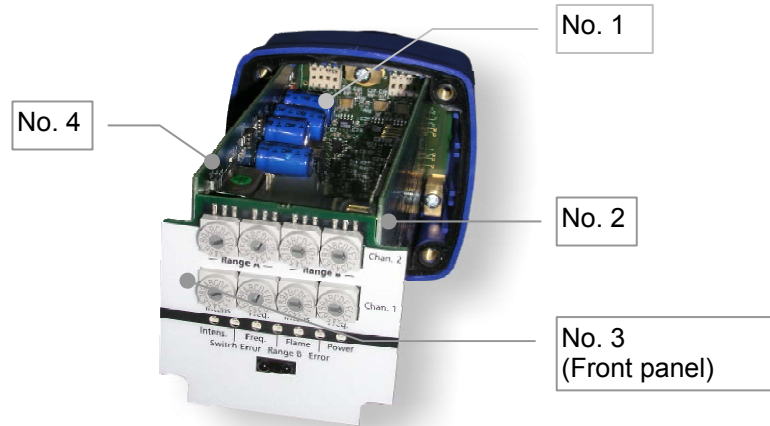

Figure 6.1: Printed circuit board numbering

For many applications it should be possible to use the D-LX 200, D-LX 720 for reliable flame monitoring either with the factory settings, or by adjusting only thresholds.

## 6.1 Adjusting the thresholds

In addition to the usual threshold for the flame intensity (Figure 6.3), the D-LX 200, D-LX 720 also offers the option of using the different flicker frequencies of the flame and the background radiation (Figure 6.4) to decide between Flame OFF and Flame ON.

The settings of both thresholds allow the commissioning engineer/operator of the furnace plant to decide which flame signal (Intens.) and which flame flicker frequency (Freq.) will be used to generate the Flame ON or OFF signal.

The thresholds are set by means of the rotary switches on printed circuit board no. 3. As the thresholds can be set differently for *Range A* and *Range B* (see 6.3 Range selection from page 59), there are separate rotary switches for both ranges (Figure 6.2). The switches for Range B only need to be operated if this range is used (see chapter 6.3 from page 59).

The thresholds can be set in 16 positions (0...9, A...F). Position 0 corresponds to the lowest setting, F to the highest setting. The relevant threshold values can be found in Figure 6.3: Setting Intensity and Figure 6.4: Flicker frequency setting [Hz] of the flame .



The rotary switches do not have a stop. They can be turned from switch position F to switch position 0. When the device is delivered, all rotary switches are set to position 0 (zero) (default setting).

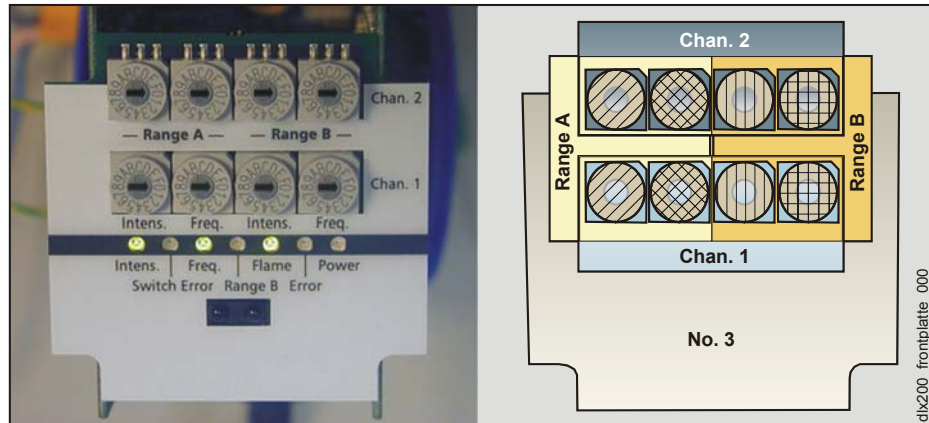

Figure 6.2: Front panel D-LX 200



The rotary switches located above each other (Figure 6.2: rotary switches with identical hatching) must be set to the **same position** within 8s. If there are any differences between the channels/rotary switches, the red "Switch Error" LED illuminates and an **error shutdown** of the Compact Flame Monitor is carried out after 8s.

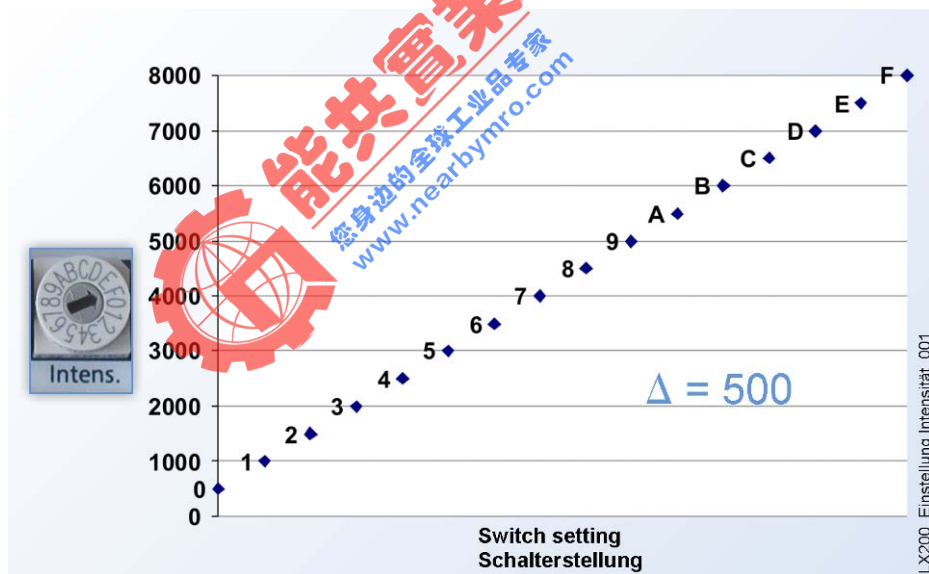

Figure 6.3: Setting Intensity

Only flames whose intensity reaches a measuring value above the intensity threshold result in a Flame ON signal. The division of the intensity on the Y-axis (see Figure 6.3) is selected arbitrarily and non-dimensionally.

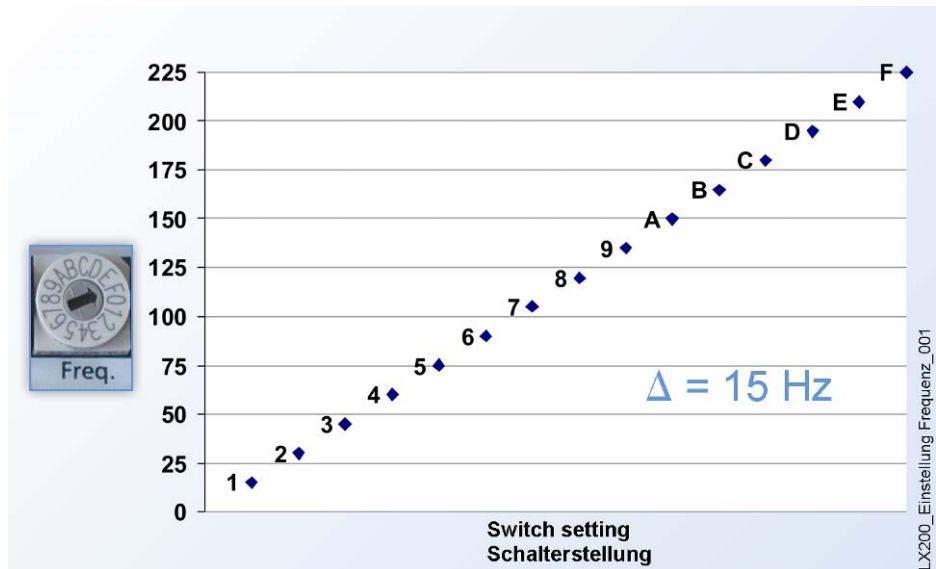

Figure 6.4: Flicker frequency setting [Hz] of the flame

For the flame flicker frequency threshold, switch position 0 (zero) means deactivation of the threshold. The detection of periodic signals is also switched off.

With a switch position > 0 (zero), a threshold is defined. The flicker frequency measured at the flame must exceed this threshold to produce a Flame ON signal (see Figure 6.4).

**Example:**

If the flicker frequency falls below 150 Hz for switch position A, the Compact Flame Monitor indicates "Flame OFF" after expiry of the safety time.

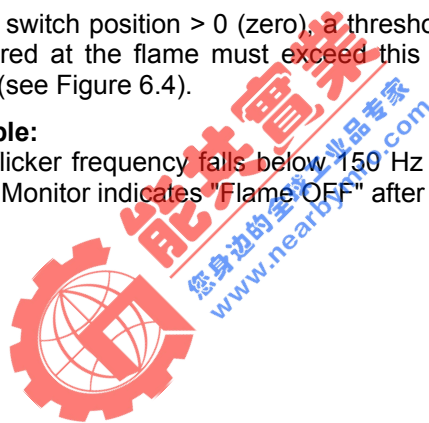



## 6.2 Setting the gain characteristic curve

A characteristic feature of the D-LX 200, D-LX 720 is the automatic adaptation of the internal gain to the signal strength of the flame. The sensitivity of the gain adaptation can be precisely matched to the relevant combustion process (by preselecting the correct gain characteristic curve).

MODE switches S3 and S4 (both on printed circuit board no.2) enable preselection of 8 different gain characteristic curves (Figure 6.5: V1-V8) for different combustion conditions. The steeper the selected gain characteristic curve, the higher the input gain of the flame monitor and the more sensitive the reaction to the flame radiation.

If gain characteristic curve V8 is selected, even a small flame radiation can result in exceeding of the threshold (intensity) and thus trigger a Flame ON signal.

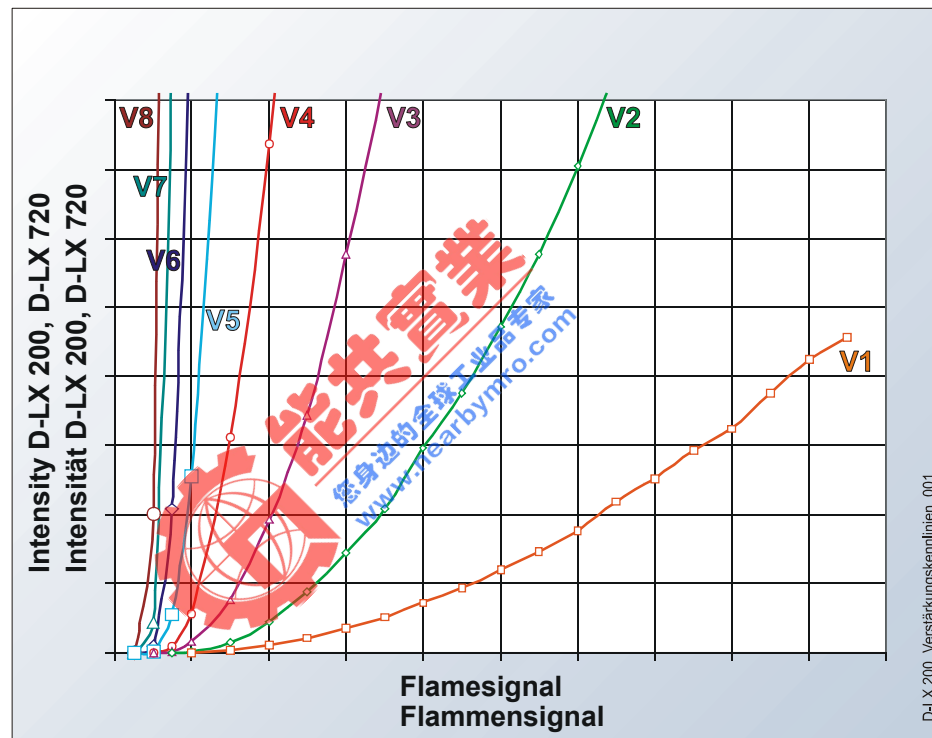

Figure 6.5: Gain characteristic curves



Gain characteristic curve V8 has the largest and V1 the smallest input gain.

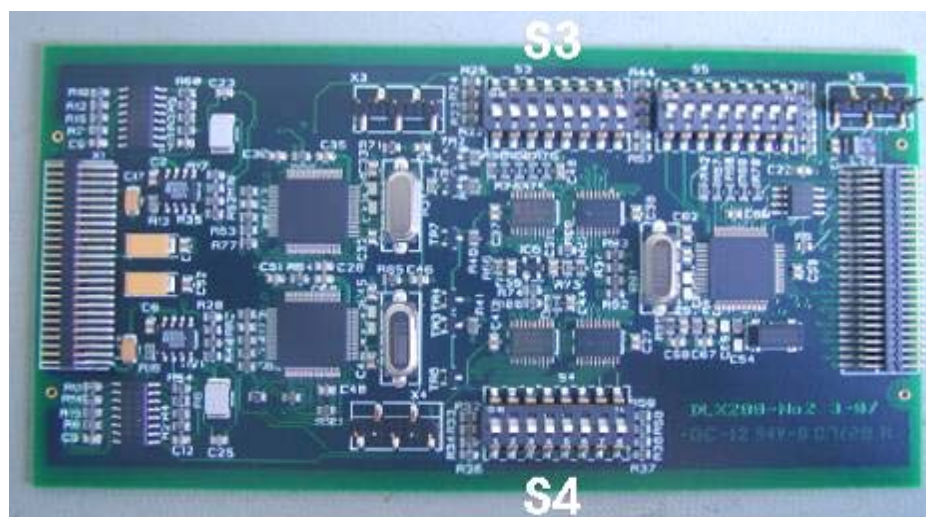

Figure 6.6: PCB no.2, (→) DIP switches S3 and S4

Gain characteristic curve	Switches S3 and S4	Range A Switch position			Range B Switch position		
		3	4	5	6	7	8
V8		off	off	off	off	off	off
V7**		on	off	off	on	off	off
V6		off	on	off	off	on	off
V5		on	on	off	on	on	off
V4		off	off	on	off	off	on
V3		on	off	on	on	off	on
V2		off	on	on	off	on	on
V1		on	on	on	on	on	on

\* DIP positions 1 and 2 must not be changed! (see 6.6 page 64)

\*\* Presetting at delivery

Table 6.1: Setting MODE switches S3 and S4

When setting the gain characteristic curve, you must ensure that MODE switches S3 and S4 are always identically set. If there are any differences between the MODE switches, the red "Switch Error" LED illuminates and an error shutdown of the flame monitor occurs after 8s.



To avoid an **error shutdown**, MODE switches S3 and S4 must be set to the same position within 8s.

## 6.3 Range selection

The purpose of range switching is to be able to use the ideal presets to detect the flame signal for two different operating states of the burner (e. g. gas and oil operation). Relevant presets are the thresholds for intensity and flame flicker frequency, as well as the gain characteristic curve.

The presets are provided independently of each other, for both ranges (Range A and Range B). Activation of the range occurs either automatically, via the burner control (e.g. in the event of fuel change, burner start, a defined boiler load or with activation of flue gas recirculation), or manually, using an external switch.



In the event of an error (interruption of the control line) the D-LX 200, D-LX 720 automatically activates Range A. In order to achieve a safe state in this case, Range A must be used for the combustion process with the stronger flame signal.

## 6.4 Setting the Modbus address

In order to use the evaluation software described in chapter 7 from page 69, "D-LX 200 InformationCentre", to display and store the data of the D-LX 200, D-LX 720, a Modbus slave address must be configured.



At delivery, the Modbus slave address is preset to "1" (**presetting**).

The Modbus slave address of the flame monitor D-LX 200, D-LX 720 can be set to Modbus slave address 1 to 64 using mode switch S5 (printed circuit board no. 2).



Please also note the information and instructions on setting the Modbus slave address in chapter 8.2 from page 83.

## 6.5 Setting process

The settings made in the factory at delivery (for thresholds and gain characteristic curves) can be adapted by the operator, if they do not prove adequate for the current application. The following flow charts show, in comprehensible form, the complex processes involved in this adaptation, which have been proven in practice.

### Aim of the setting

#### Flame OFF settings:

When the burner is switched off, the thresholds are set so high that the flame monitor always indicates "Flame OFF".

- The "Flame" LED on the front panel must be dark

- The flame intensity current is less than 5mA (0-20mA) or 8mA (4-20mA)
- The value of the flame intensity display in the D-LX 200 evaluation software is less than 25%
- The relay output for the Flame ON signal is open

**Flame ON settings:**

When the burner is switched on, the flame monitor must always exceed the set thresholds and indicate "Flame ON".

- The "Flame" LED on the front panel must light up green
- The flame intensity current is greater than 10mA (0-20mA) or 12 mA (4-20mA)
- The value of the flame intensity display in the D-LX 200 evaluation software is greater than 25 %
- The relay output for the Flame ON signal is closed

**Basic setting:**

- MODE switches S3 and S4 (printed circuit board no.2) must be set to current gain characteristic curve V8 (Table 6.1 page 58).
- All rotary switches (printed circuit board no.3) must be at switch position 0.

### 6.5.1 Setting by means of current output/LED

Before commencing setting tasks on the Compact Flame Monitor, loosen the hood using the four Allen screws and carefully remove it backwards.



If the printed circuit boards have become loose after removing the hood, you must ensure that the terminal strips on the printed circuit boards are not misaligned when reassembled. This could result in severe damage to the D-LX 200, D-LX 720.

A measuring device (ampere meter) must also be connected to the current output (see connection plan Figure 11.1 page 103).

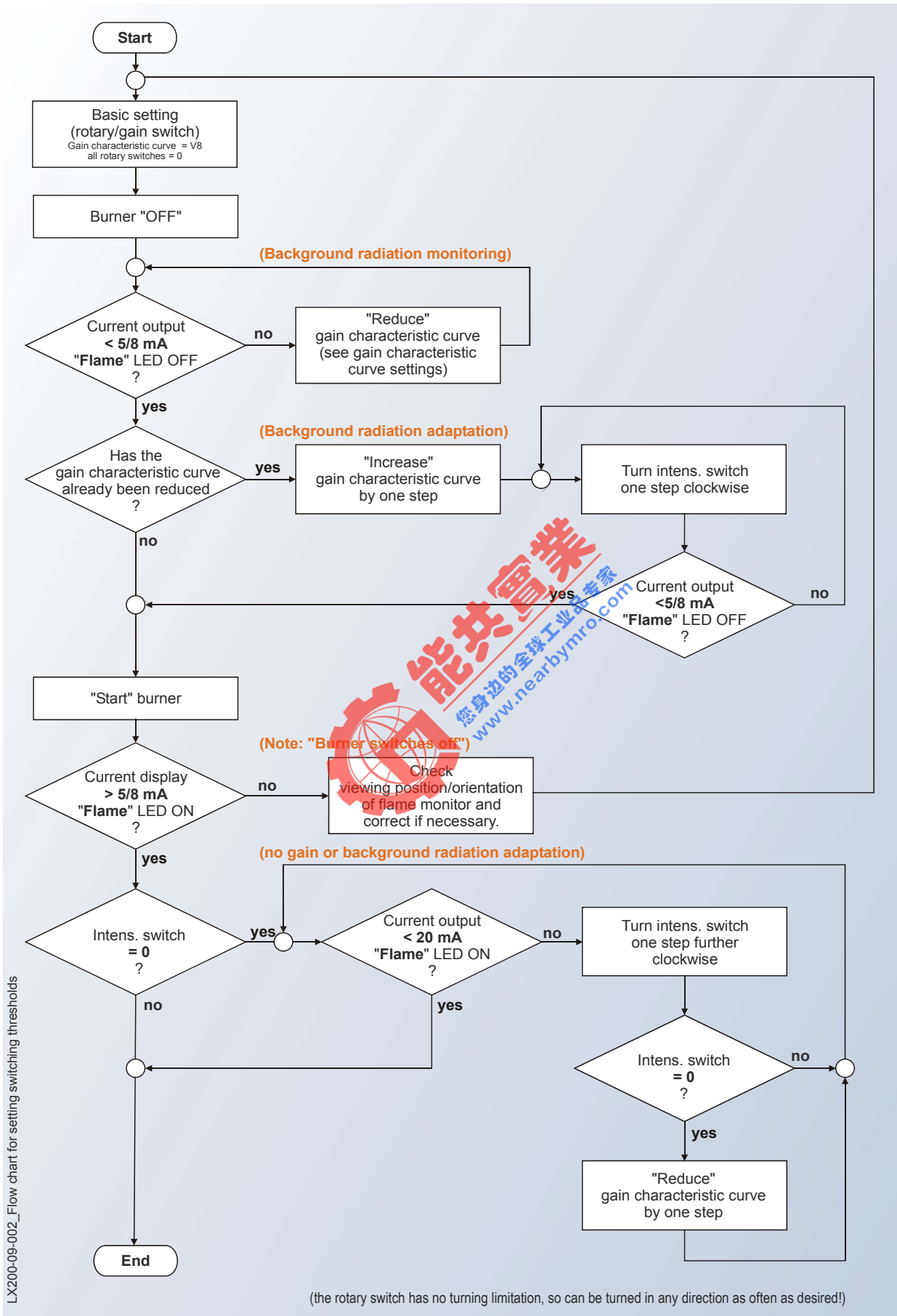

LX200-09-002\_Flow chart for setting switching thresholds

Figure 6.7: Flow chart for settings by means of current output/LED



As far as possible, make the settings on the flame monitor so that the monitor indicates 0 or 4 mA for Flame OFF and 20 mA for Flame ON.

The flame monitor must prevent simulation of a flame in all operating states and under the most diverse combustion conditions.

With optimal adjustment of the viewing position, the gain characteristic curve and the thresholds of the flame monitor, the D-LX 200, D-LX 720 must always reliably indicate a switched-off burner or an unacceptable deterioration in the flame pattern. The influence of background radiation sources must not be allowed to generate a defective system state.

If, after setting the flame monitor to be insensitive to background radiation, the monitor can no longer detect its own flame, the difference between background radiation and useful light (flame to be monitored) is too small. In this case, it is advisable to switch the gain characteristic curve one "gain characteristic curve higher" with the MODE (DIP) switches. The steeper characteristic curve enables a greater signal difference between background radiation and useful light.



If Range A **and** Range B are used, the settings for each range must be made separately!

Please also note the information for the Range selection from page 59.

### 6.5.2 Setting by means of D-LX 200 InformationCentre

Before commencing setting tasks on the Compact Flame Monitor, loosen the hood using the four Allen screws and carefully remove it backwards.



If the printed circuit boards have become loose after removing the hood, you must ensure that the terminal strips on the printed circuit boards are not misaligned when reassembled. This could result in severe damage to the D-LX 200, D-LX 720.

In addition, the data communication between the PC and the D-LX 200, D-LX 720 must be established with a USB/RS485 serial interface converter (see connection plan Figure 11.1 page 103). The InformationCentre software visualises and documents the configuration of the D-LX 200, D-LX 720. Settings on the Compact Flame Monitor are made manually using the rotary and (→) DIP switches, as previously described. You can find a description of the InformationCentre in chapter 7 from page 69. After establishing the data connection InformationCentre must be started.

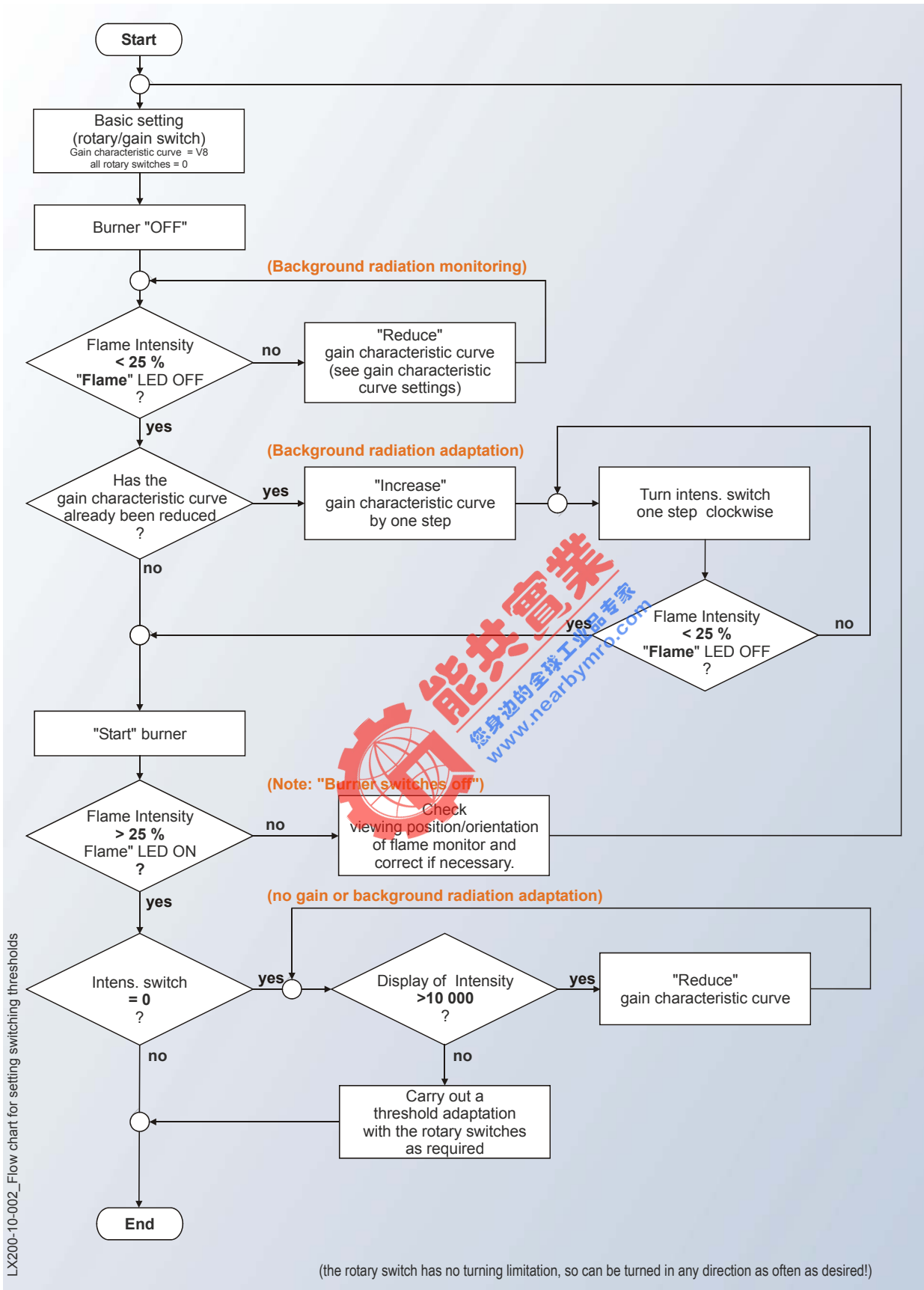

Figure 6.8: Flow chart for settings by means of InformationCentre



As far as possible, make the settings on the flame monitor so that the monitor indicates 0 or 4 mA for Flame OFF and 20 mA for Flame ON.

The flame monitor must prevent simulation of a flame in all operating states and under the most diverse combustion conditions.

With optimal adjustment of the viewing position, the gain characteristic curve and the thresholds of the flame monitor, the D-LX 200, D-LX 720 must always reliably indicate a switched-off burner or an unacceptable deterioration in the flame pattern. The influence of background radiation sources must not be allowed to generate a defective system state.

If, after setting the flame monitor to be insensitive to background radiation, the monitor can no longer detect its own flame, the difference between background radiation and useful light (flame to be monitored) is too small. In this case, it is advisable to switch the gain characteristic curve one "gain characteristic curve higher" with the MODE (DIP) switches. The steeper characteristic curve enables a greater signal difference between background radiation and useful light.



If Range A **and** Range B are used, the settings for each range must be made separately!

Please also note the information for the Range selection from page 59.

## 6.6 Safety time

The safety time is the response time of the flame monitor to an outage of the flame signal (digital signal from the (→) flame radiation and the resulting switch-off of the relay contact for the Flame ON signal).

The Compact Flame Monitor D-LX 200, D-LX 720 has a default safety time of 1 second. Further default values (2 s, 3 s and 5 s) are available on request. The safety time noted on the type plate must match the safety time set on the device.







Burner controls and flame monitors are type-approved devices. *Any interventions or modifications will result in loss of the approval.* Repairs may therefore only be carried out by the manufacturer or his representatives.

The adjustment of flame monitors should also only be performed by appropriately trained personnel, in the interest of safety.

DURAG offers suitable training for this purpose.

Particular care must be taken not to change switch positions 1 and 2 (see Figure 6.6 and Table 6.1 on page 58) when setting the gain characteristic curves at DIP switches S3 and S4. The switch position corresponding to the safety time noted on the type plate can be verified in Table 6.2.



Safety time	Switches S3 and S4	Switch position	
DIP position*		1	2
1s		off	off
2s		on	off
3s		off	on
5s		on	on

\* DIP positions 1 and 2 must be set in accordance with the safety time noted on the type plate!

Table 6.2: Setting MODE switches S3 and S4



To avoid an error shutdown, MODE switches S3 and S4 must be set to the same position within 8s.





---

D-LX 200

D-LX 720

## Compact Flame Monitor

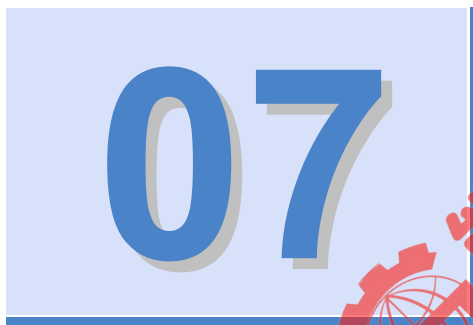

---

### **7 D-LX 200 InformationCentre PC Version**

- 7.1 System requirements
  - 7.2 Installation
  - 7.3 Start / Execute
    - 7.3.1 Flame Information
    - 7.3.2 Flame Sensor Signal
    - 7.3.3 System Settings
  - 7.4 Pull-down menus
    - 7.4.1 File
    - 7.4.2 Connection
    - 7.4.3 Option
  - 7.5 Error messages
  - 7.6 Structure of the stored data records
-



## 7 D-LX 200 InformationCentre PC Version

The D-LX 200, D-LX 720 evaluation software "D-LX 200 InformationCentre" is designed to display and store the date of these devices. Originally developed for DURAG Service technicians, the configuration help is now also available to enable effective and time-saving performance of adjustment tasks.



The software is *not* a constituent of the Compact Flame Monitor D-LX 200, D-LX 720 and can be modified or limited in functionality at any time without prior notice. There is no entitlement to the "InformationCentre". In the event of program modifications, generally only the online help is updated promptly. Although the evaluation software and the associated information have been compiled with the greatest care, all liability must be excluded. The exclusion of liability is acknowledged with installation of the software on the computer.

### 7.1 System requirements

The system requirement is an IBM-compatible PC with Microsoft Windows 2000 or Microsoft Windows XP operating system.

The recommended performance features of the system are min. 1GHz processor, 256MByte RAM and a screen resolution of 1024\*768. The font size setting should be 96 dpi, as otherwise incorrect displays can result.

Data is transferred between D-LX 200, D-LX 720 and PC via an RS-485 interface. If the PC does not have a serial interface (COM), an appropriate USB to RS 485 adapter can be used. If a true serial interface is present, an RS232 to RS485 (2-wire) converter is required.

### 7.2 Installation

To install the software, the Setup.Exe is started in the folder "D-LX 200 Installer". The program should be installed in the folder "C:\Programs\D-LX 200" if possible, and is ready for execution when installation is complete.

The D-LX 200, D-LX 720 is connected to the PC either with an RS232/RS485 or a USB/RS485 adapter (see connection plan Figure 11.1 page 103).

The interface configuration of the PC must be set **before** starting the software, i.e. the USB/RS485 adapter must be connected and installed, using the manufacturer's driver CD if necessary. The PC's interface setting can be checked under:

"Workstation → System properties → Hardware → Device manager → Connections"

The correct Modbus slave address must be set in the device (D-LX 200, D-LX 720). See chapter 6.4 from page 59. The Modbus slave address is set to "1" at delivery.

### 7.3 Start / Execute

During installation, an entry is created automatically in the Windows start menu:

"Start → Programs → D-LX 200 → D-LX 200 InformationCentre"

Use this entry to call up the program. The following screen appears on the monitor.

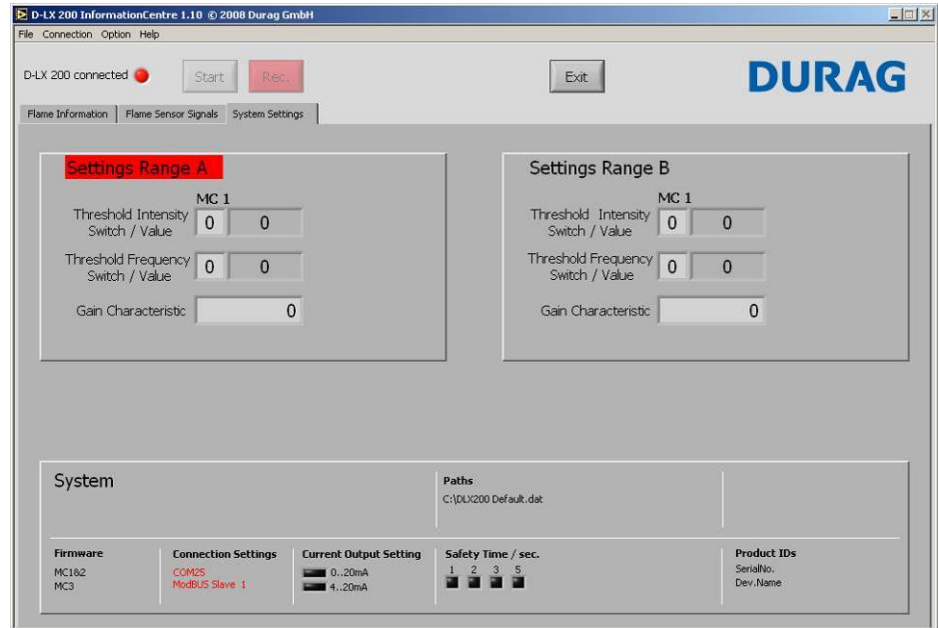

**Figure 7.1: InformationCentre front screen**

The indicator field "D-LX 200 connected" indicates whether a connection has been made. If so, this field lights up green. If it remains red, although a D-LX 200, D-LX 720 is connected and ready for operation, the communication interface settings must be checked and corrected if necessary. Other error sources may be the interface cable, an inadequate electrical contact and the adapter used.

The COM port and the Modbus slave address set on the D-LX 200, D-LX 720 can be selected in the "Connection" pull-down menu. Details on setting the Modbus slave address can be found in chapter 8.2 from page 83. This address is necessary, as the device uses the Modbus protocol. Several nodes can be connected to one bus. They are selected by means of the different addresses.

After selecting the "Connection" menu the following screen appears:

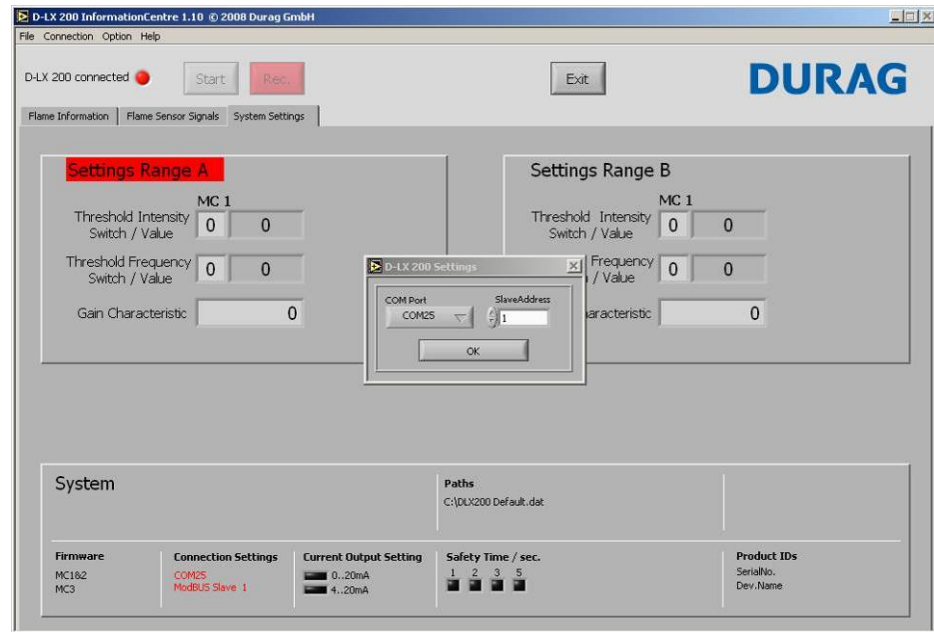

Figure 7.2: "Connection" menu of the InformationCentre

If the connection has been successfully established, the program changes to the following display:

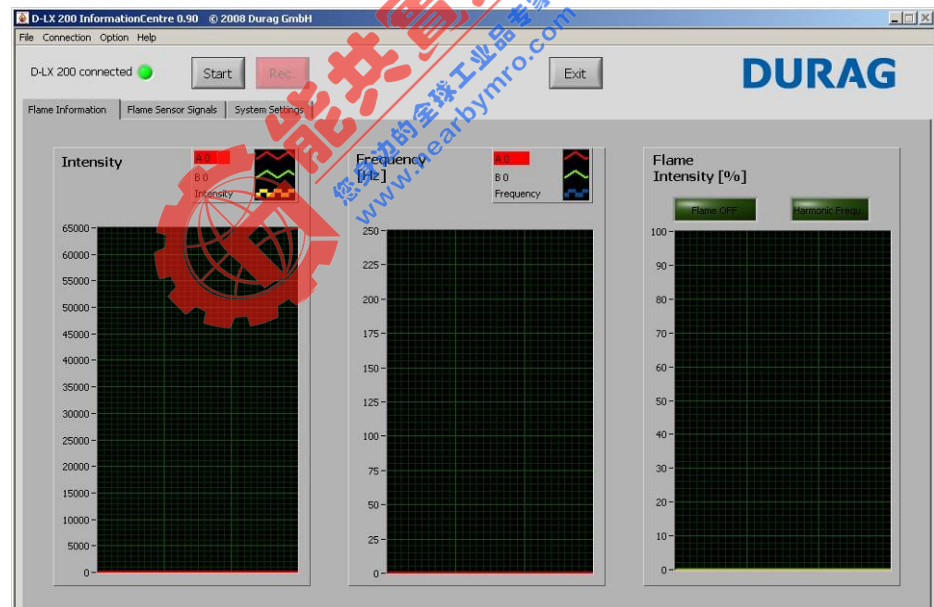

Figure 7.3: Display view of the InformationCentre

The actual data transfer from the D-LX 200, D-LX 720 is initiated with the "Start" key. The software user interface is divided into three views, which can be selected using the "Flame Information", "Flame Sensor Signal" and "System Settings" tabs.

### 7.3.1 Flame Information

The display screen for the "Flame Information" shows the graphs "Intensity", "Frequency" and "Flame Intensity".



Figure 7.4: Display view Flame Information

#### Intensity

The "Intensity" value is the integral of the alternating component of the flame signal with inclusion of the gain factor. The "Intensity" graph also displays two threshold values with a red and a green line. These show the thresholds set on the D-LX 200, D-LX 720 (RangeA / RangeB), which result in the "Flame ON" operating state when exceeded. The threshold value of the active range is displayed in red.

#### Frequency

The "Frequency" value indicates the measured flame flicker frequency. The additional lines show the threshold values for the frequency (active range red), as in the "Intensity" graph.

#### Flame Intensity

The Flame Intensity is a combination between intensity and frequency. It represents the determined flame signal in the range 0-100%. The graph also contains two further indicators, "Flame" and "Harmonic Freq.". As the descriptions show, the former indicates the flame detection and the latter the detection of a periodic measuring signal.



### 7.3.2 Flame Sensor Signal

The view shows the current setting for the internal amplifier stages (ACvu and DCvu), the signal for a measuring cycle (AC signal) and the DC signal (DC signal of the flame / continuous light portion of the flame radiation). The values for "Intensity", "Frequency", "Flame Intensity" and **Flame ON** or **Flame OFF** are also displayed here as status information. Figure 7.5 shows an example signal.



Figure 7.5: Signal for a measuring cycle



### 7.3.3 System Settings

The "System Settings" display shows all static and parameterizable values, such as the threshold values for "Threshold Intensity" and "Threshold Frequency", the "Safety Time", the current output (0-20 / 4-20mA), the serial number, the device type, the interface setting, the firmware versions and the default file in which data is saved when the "Rec." key is activated. The display is divided into **Settings Range A** and **Settings Range B**.

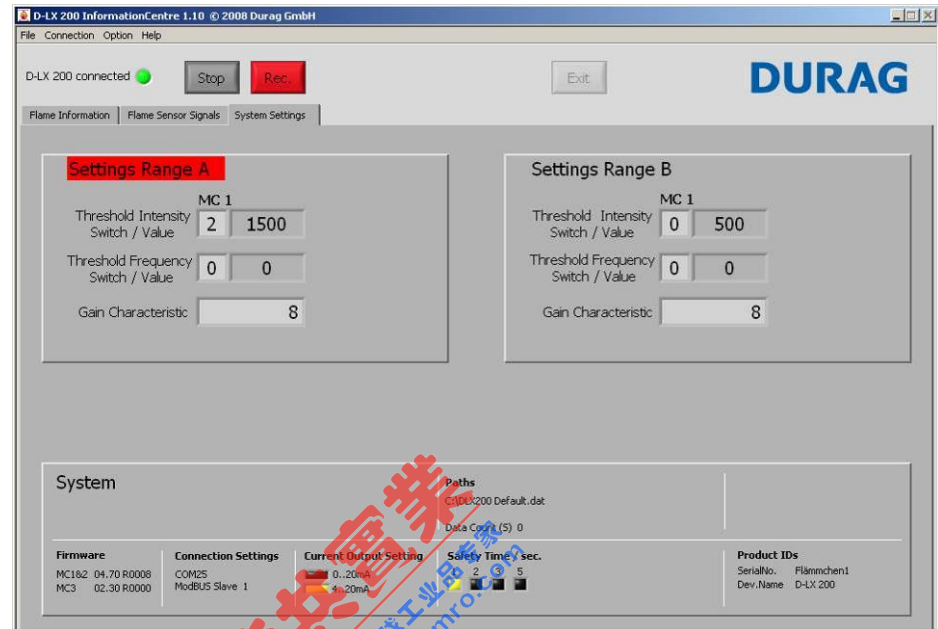

Figure 7.6: System Settings

<b>Threshold Intensity</b>	(1 <sup>st</sup> value) Displays setting of the <b>Intens.</b> rotary switch
<b>Switch / Value</b>	(2 <sup>nd</sup> value) Intensity threshold
<b>Threshold Frequency</b>	(1 <sup>st</sup> value) Displays setting of the <b>Freq.</b> rotary switch
<b>Switch / Value</b>	(2 <sup>nd</sup> value) Frequency threshold
<b>Gain-Characteristic</b>	Displays gain characteristic curve
<b>Firmware</b>	Firmware version/revision for D-LX 200
<b>Connection Setting</b>	Displays the interface and the Modbus slave address used
<b>Current Output Setting</b>	Current output 0..20mA or 4..20mA
<b>Paths</b>	Storage path + name of archive file in which the measured data is recorded
<b>Data Count</b>	Number of data records contained in the archive file
<b>Safety Time</b>	Displays the safety time
<b>SerialNo</b>	Serial number
<b>Dev.Name</b>	Device type

Table 7.1: System Settings

## 7.4 Pull-down menus

### 7.4.1 File

The "File" menu is divided into 3 submenus, "SelectFile", "FileSetting" and Exit (see Figure 7.7). Under "SelectFile" you can set the path and the file in which data will be saved.

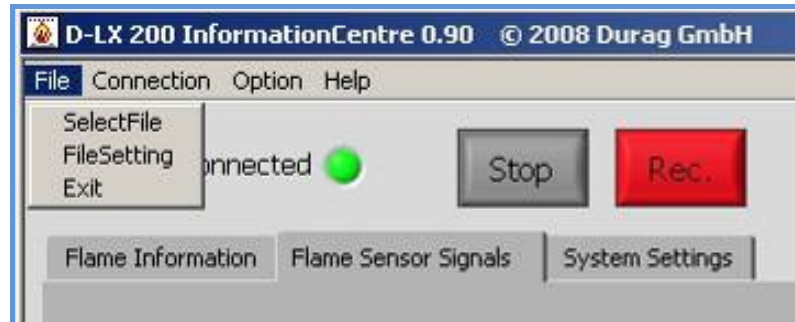

Figure 7.7: "File" menu

In the "FileSetting" submenu (Figure 7.8) you can select the storage interval (all data or 1 data record / second) and the number of data records / file. If this quantity is exceeded, the program automatically creates a new file.

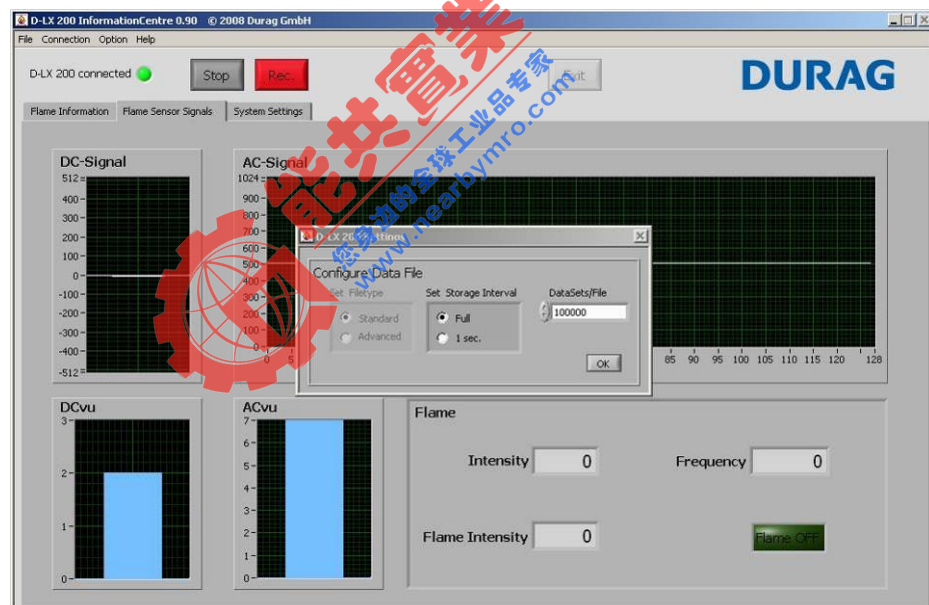

Figure 7.8: "FileSetting" submenu

### 7.4.2 Connection

In the "Connection/SelectCOM" menu you can set the COM port and the Modbus slave address (see Figure 7.2). If a D-LX 200, D-LX 720 is "connected", then the COM port field is deactivated. Only the Modbus slave address can be modified.

### 7.4.3 Option

The "Option" menu is divided into two submenus, "Service" and "Adjust CurrentOutput".

#### Service

The "Service" function is undocumented and reserved for the specially trained DURAG Service personnel.

#### Adjust CurrentOutput

The D-LX 200, D-LX 720 has a current output of 0-20mA. This can be set to 0-20mA or 4-20mA using the DIP switch in the device (see Table 6.2 from page 65). With the help of the "Adjust CurrentOutput" menu item the user can trim the current output, i.e. the values 0mA, 4mA and 20mA can be parameterized more precisely using different step widths and the "+ / -" keys. These values can then be stored in the D-LX 200, D-LX 720 (see Figure 7.9).



Figure 7.9: "Adjust CurrentOutput" submenu



The current output range noted on the type plate must match the range set on the device!

## 7.5 Error messages

In the event of an error shutdown an extra window opens, in which the error numbers and, if available, the error plain text messages can be displayed. The program continues to update the data.

As the D-LX 200, D-LX 720 has gone into the so-called error position (red "Error" LED on the front of the D-LX 200, D-LX 720), the old data is repeatedly transmitted. In order to continue operation, the causes of the fault must be eliminated if possible. The device must also be retrieved from the error position by briefly interrupting the power supply or using RESET.

A possible error screen is displayed in Figure 7.10 .

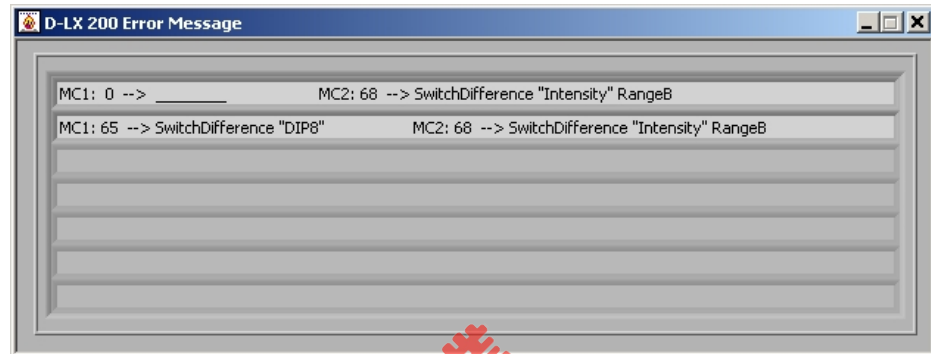

Figure 7.10: Extra window with error message

## 7.6 Structure of the stored data records

The InformationCentre gives you the option of storing the determined data. Information on the necessary settings can be found in chapter 7.4.1 File on page 75. The storage process is started with the "Rec" key (see Figure 7.7 on page 75). Data is now continuously written to the previously defined location.

The file content is structured as follows. The first part, only present once, is a so-called header.

```
<HEADER> <SN>Frank00002 <DT>0011.4925.0000.0000 <FW1>04.70 R0007
<FW3>02.20 R0002 <END>
```

This header provides information on the master data of the device:

- SN – Serial number
- DT – Device Type
- FW1 & FW3 Firmware & revision status of the device.

The measured data then follows in 195 byte sequences. There are no field separators or gaps in the data record.

The following table describes the data record structure and the interpretation of the fields.

1 . . . . . 128	<b>128 AD values</b>								
129 . . 160	<b>free</b>								
<b>32 8bit parameters</b>									
		8	7	6	5	4	3	2	1
161	Param(01)	AD values minimum							
162	Param(02)	AD values maximum							
163	Param(03)	AD values mean							
164	Param(04)	Free							
165	Param(05)	DC signal MC2							
166	Param(06)	DC signal MC1							
167	Param(07)	Max. frequency							
168	Param(08)	Intensity 16bit (High-Byte)							
169	Param(09)	Intensity 16bit (Low-Byte)							
170	Param(10)	Flame intensity by MC3							
171	Param(11)	MC1 <i>Error code</i>							
172	Param(12)	MC1 <i>Gain</i>							
		AC Gain (AC vu)				DC Gain (DC vu)			
173	Param(13)	Safety time for flame OFF Interval 200ms							
174	Param(14)	MC1 <i>FLW config info</i>							
		SSL-B	SSL-B	SSL-B	SSL-A	SSL-A	SSL-A	SZ	SZ
175	Param(15)	MC1 <i>Switch position/Limits Range A</i>							
		Frequency [A]				Intensity [A]			
176	Param(16)	MC1 <i>Switch position/Limits Range B</i>							
		Frequency [B]				Intensity [B]			
177	Param(17)	MC2 <i>Error code</i>							
178	Param(18)	FLW-Status Information MC1							
		Current output [0] 0..20mA [1] 4..20mA	free	Flame	Harmonic	Range A[0] / B[1]	Switch difference MC1↔MC2	Frequency OK	Intensity OK

179	Param(19)	<i>FLW-Status Information MC1</i>							
180	Param(20)	Free							
181	Param(21)	Free							
182	Param(22)	Free							
183	Param(23)	Harmonic detection 00..50							
184	Param(24)	Free							
185	Param(25)	<i>MC2 Switch position/Limits Range A</i>							
		Frequency [A]				Frequency [A]			
186	Param(26)	<i>MC2 Switch position/Limits Range B</i>							
		Frequency [B]				Frequency [B]			
187	Param(27)	<i>MC2 FLW config info</i>							
		SSL-B	SSL-B	SSL-B	SSL-A	SSL-A	SSL-A	SZ	SZ
188	Param(28)	<i>MC2 Gain</i>							
		AC Gain (AC vu)				DC Gain (DC vu)			
189	Param(29)	Free							
190	Param(30)	Free							
191	Param(31)	Free							
192	Param(32)	Free							
193	Param(x1)	Free							
194	Param(x2)	Data record counter							
195	Param(x3)	MC2				MC1			

Table 7.2: Data record structure







---

D-LX 200  
D-LX 720

## Compact Flame Monitor

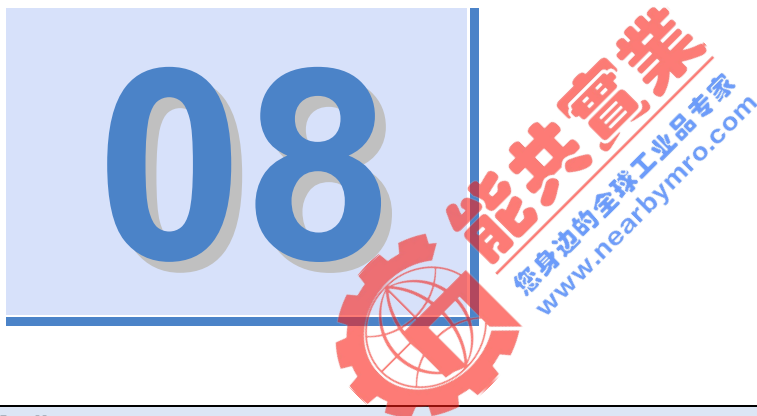

---

### **8 Modbus**

- 8.1 Hardware and boundary conditions
- 8.2 Setting the Modbus slave address
- 8.3 Modbus
- 8.4 DURAG Modbus DataMap



## 8 Modbus

This chapter deals with the device-specific areas of the Modbus interface and the Modbus implementation for the D-LX 200, D-LX 720. This description therefore does not provide complete information on all areas of the Modbus protocol.

General information on Modbus and the DURAG Modbus can be found in the separate DURAG Modbus Manual and on the Internet (<http://www.modbus.org/>).

The (→) RS-485/field bus interface of the D-LX 200, D-LX 720 is used to provide parameters and settings, and to query the current status. The Modbus protocol is used.

The data communication is Master(Client) / Slave(Server) . The Compact Flame Monitor acts exclusively as "slave", i.e. it only reacts and responds to valid Modbus queries at the request of the Modbus master.

The RS-485/Modbus interface enables data transfer over large distances (up to 1200 m) and parallel connection of a number of devices (max. 32 are provided for). The data cables must be implemented as twisted pairs.

### 8.1 Hardware and boundary conditions

The Compact Flame Monitor D-LX 200, D-LX 720 is equipped with an RS485/Modbus interface.

The RS485/Modbus data connection is established using connection terminals 7 (RS485 A) and 8 (RS485 B) or, in the case of a preassembled connection cable, using the pink (RS485 A) and the grey wires (RS485 B). In the case of RS485/Modbus data communication, correct termination of the data bus or RS485 interface must generally be ensured.

For this purpose the D-LX 200, D-LX 720 is equipped with a 120 ohm terminating resistance on printed circuit board no. 4, which can be activated by jumper X2 (see Figure 8.1 and Table 8.1 on page 84).

### 8.2 Setting the Modbus slave address

The D-LX 200, D-LX 720 is connected to the PC either with an RS232/RS485 or a USB/RS485 adapter (see connection plan Figure 11.1 page 103).

The interface configuration of the PC must be set **before** starting the software, i.e. the USB/RS485 adapter must be bonded and installed.



Figure 8.1: PCB no.4, jumper X2"

Termination ON		Termination OFF**	
----------------	--	-------------------	--

\*\*Preset at delivery

Table 8.1: Setting the jumper X2

The Modbus slave address of the D-LX 200, D-LX 720 flame monitor can be set to Modbus slave addresses 1 to 64 with mode switch S5 (printed circuit board no.2) (i.e. the address space is larger than the max. number of operable devices).



At delivery, the Modbus slave address is preset to "1".

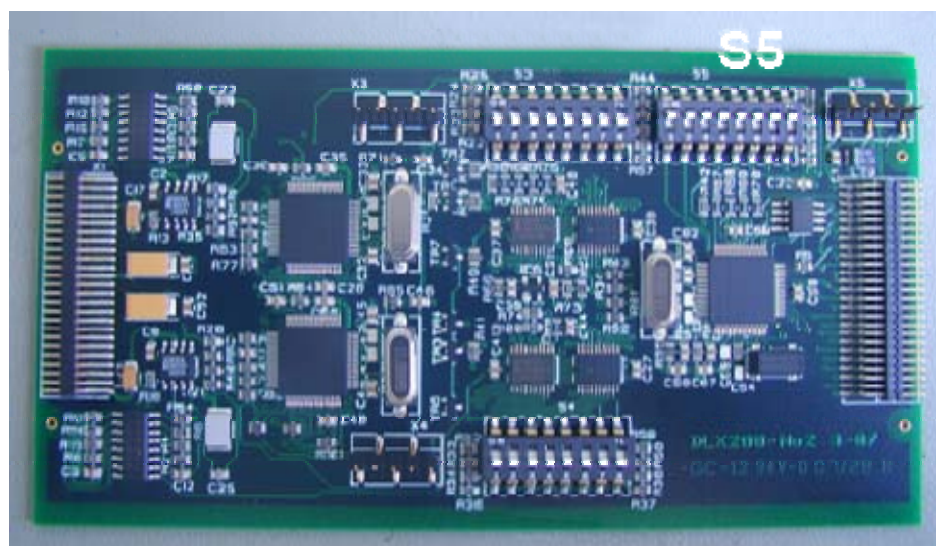













Figure 8.2: PCB no.2, (→) DIP switch S5

The D-LX 200, D-LX 720 flame monitor supports the Modbus RTU (remote terminal unit) protocol format with serial transfer format:

(8E1) 1 start bit, 8 data bits, Even-Parity and 1 stop bit with data transfer rates 9600bps and 19200bps.

The address is set according to the following table:

Description	Switch position	Switch position						Current output	
		Modbus slave address						7*	8
DIP position*		1	2	3	4	5	6	7*	8
0...20mA									on
4...20mA									off
reserved*									
<b>Modbus ADDR 1**</b>		on	on	on	on	on	on		
Modbus ADDR 2		off	on	on	on	on	on		
Modbus ADDR 3		on	off	on	on	on	on		
Modbus ADDR 4		off	off	on	on	on	on		
Modbus ADDR 5		on	on	off	on	on	on		
Modbus ADDR 6		off	on	off	on	on	on		
...									
Modbus ADDR 9		on	on	on	off	on	on		
...									
Modbus ADDR 64		off	off	off	off	off	off		

\* DIP position 7 is reserved!  
 \*\* **Presetting** at delivery

Table 8.2: Setting for MODE switch S5



The current output range noted on the type plate must match the range set on the device!

### 8.3 Modbus

Slave Address	FunctionCode	Data	CRC
1 byte	1 byte	0 up to 252 byte(s)	2 bytes CRC Low, CRC Hi

Table 8.3: Modbus RTU Message Frame

0	from 1 to 247	from 248 to 255
Broadcast address	Slave individual addresses	Reserved

Table 8.4: Modbus Slave Address Range

The D-LX 200, D-LX 720 flame monitor supports the following Modbus FunktionCodes:

FunctionCode	FunctionCode description
03	Read holding register (16Bit)
04	Read input register (16Bit)
06	Write Single Register (16Bit)
16	Write Multiple Register (16Bit)

**Table 8.5: Modbus FunktionCode**

If an invalid Modbus query is sent to the D-LX 200, D-LX 720 , it will send a corresponding Exception Message as Modbus response, e.g. if the FunktionCode is not supported or an invalid data address is queried.

If a FunktionCode is not supported, Modbus Exception 01 "ILLEGAL FUNCTION" is returned.

If attempts are made to read or write to an unavailable or blocked storage area, Modbus Exception 02 "ILLEGAL DATA ADDRESS" is sent.

### Modbus FunctionCode(0x03..0x04) Read 16BitRegisters

(for details see Modbus Specification)

#### Request

Slave Address	1 Byte	0, 1..254
FunctionCode	1 byte	<b>0x03...0x04</b>
Starting Address	2 bytes	0x0000 to 0xFFFF
Quantity of Input Registers	2 bytes	0x0001 to 0x007D
CRC	2 bytes	SA, FC      DATA

**Table 8.6: Modbus FunctionCode(0x03..0x04) Read 16BitRegisters Request**

#### Response

Slave Address	1 byte	0, 1..254
FunctionCode	1 byte	<b>0x03...0x04</b>
Byte count of... ...Input Registers	1 Byte	2 x <b>N*</b>
Register Value	<b>N*</b> x 2 Bytes	Value
CRC	2 Bytes	SA, FC      DATA

\***N** = Quantity of Registers

**Table 8.7: Modbus FunctionCode(0x03..0x04) Read 16BitRegisters Response**

### Modbus FunctionCode(0x10) Write Multiple 16BitRegisters

(for details see Modbus Specification)

#### Request

Slave Address	1 byte	0, 1..254	
FunctionCode	1 byte	<b>0x10</b>	
Starting Address	2 bytes	0x0000 to 0xFFFF	
Quantity of... ...Registers	2 bytes	0x0001 to 0x007D	
Byte count of... ...Registers	1 byte	2 x N*	
Register Value	N* x 2 bytes	Value	
CRC	2 bytes	SA, FC	DATA

\*N = Quantity of Registers

Table 8.8: Modbus FunctionCode(0x10) Write Multiple 16BitRegisters Request

#### Response

Slave Address	1 byte	0, 1..254	
FunctionCode	1 byte	<b>0x10</b>	
Starting Address	2 bytes	0x0000 to 0xFFFF	
Quantity of... ...Registers	2 bytes	1 to 123 (0x7B)	
CRC	2 bytes	SA, FC	DATA

\*N = Quantity of Registers

Table 8.9: Modbus FunctionCode(0x10) Write Multiple 16BitRegisters Response

## 8.4 DURAG Modbus DataMap

### Modbus register and address information for the D-LX 200, D-LX 720

Parameter Description	Register Quantity	Register Addr.[dec/hex]	Data format	Content
Device information				
Manufacturer name	10	0 / 0x0000	ASCII	DURAG GmbH \x00\x00 \x00\x00 \x00\x00 \x00\x00 \x00\x00
Device name	10	10 / 0x000A	ASCII	D-LX 200 \x00\x00 \x00\x00 \x00\x00 \x00\x00 \x00\x00 if req. D-LX 720 \x00\x00 \x00\x00 \x00\x00 \x00\x00 \x00\x00
Device type	4	20 / 0x0014	BCD	0011.7320 xxxx xxxx if req. 0011.7321 xxxx xxxx
Device serial number	5	24 / 0x0018	ASCII	1234567890
Primary device firmware revision	2	34 / 0x0022	BCD	01.00 R 0000
Secondary device firmware revision	2	36 / 0x0024	BCD	01.00 R 0000

Parameter Description	Register Quantity	Register Addr.[dec/hex]	Data format	Content
Bus information				
Modbus address	1	128 / 0x0080	Word	1..247
Device protocol revision common	1	129 / 0x0081	BCD	01.00
Device protocol revision specific	1	130 / 0x0082	BCD	01.00
Actual Date / Time	2	131 / 0x0083	Date Time	UnixTimeCode Read/Write
Baud rate	1	133 / 0x0085	Word	9600bps[0]/19200bps[1]

Table 8.10: Modbus register and address information

The parameters described below and the Modbus registers for the flame monitor D-LX 200, D-LX 720 are contained in the "device-specific" address space of the DURAG Modbus DataMap.



Parameter Description	Note*	Register Quantity	Register Addr.[dec/hex]		Modbus Register Content			
					R0H	R0L	R1H	R1L
<b>DEVICE SPECIFIC AREA</b>								
Data record identifier		1	2049	0801	0..65000		x	x
Analogue current gain MC1&MC2	A	1	2050	0802	MC1: ACvu   DCvu	MC2: ACvu   DCvu	x	x
DC signal MC1		1	2051	0803		0..255	x	x
DC signal MC2		1	2052	0804		0..255	x	x
Intensity (16bit) MC1&MC2		2	2053	0805	Intensity MC1		Intensity MC2	
Frequency MC1&MC2		1	2055	0807	Frequency MC1	Frequency MC2	x	x
Flame intensity		1	2056	0808	0x00	0..100	x	X
Thresholds Range A	F	1	2057	0809	MC1: Freq   Intens	MC2: Freq   Intens	x	x
Thresholds Range B	F	1	2058	080A	MC1: Freq   Intens	MC2: Freq   Intens	x	x
Current gain characteristic curve MC1&MC2	G	1	2059	080B	MC1: GCB   GCA	MC2: GCB   GCA	x	x
Safety time info MC1	H	1	2060	080C	1,2,3,5 seconds	SZFA (5s)24..0	x	x
Safety time info MC2	H	1	2061	080D	1,2,3,5 seconds	SZFA (5s)24..0	x	x
Flame monitor status information	I	1	2062	080E	MC1: StatusInfo	MC2: StatusInfo	x	x
Harmonic detection MC1&MC2		1	2063	080F	MC1: 50..0	MC2: 50..0	x	x
Error message MC1&MC2		1	2064	0810	MC1: Error	MC2: Error	x	x
Time stamp RTC/UnixTimeCode		2	2065	0811	Unix TimeCode 32Bit			
MC1 AD value Min/Max RMS	M	2	2067	0813	MIN	MAX	RMS	
AD values MC1	N	64	2069	0815	AD0	AD1	AD2	AD3
MC2 AD value Min/Max RMS	M	2	2149	0865	MIN	MAX	RMS	
AD values MC2	N	64	2151	0867	AD0		AD1	AD2
Error information D-LX 200, D-LX 720	L	1	2288	08F0	0x00		MCx Error	

\* Meaning and explanations of the entries used (A, F, etc.) can be found on the following pages

**Table 8.11: Modbus register and device-specific address information**

\*Explanation of the parameters

**A** Analogue current gain

<b>MSB</b>						<b>LSB</b>
AC Gain (ACvu) [0..8]				DC Gain (DCvu) [0..3]		

**F** Threshold

<b>MSB</b>		<b>LSB</b>
Frequency [0..15]		Intensity [0..15]

**G** Gain characteristic curve

Gain Characteristic for Range **A** and **B**

**H** (→) Safety time

This parameter contains the set safety time 1,2,3,5 seconds as BCD value, and the current flame OFF safety time (SicherheitsZeitFlammenAbmeldung) is also specified.

**I** Flame monitor status information

Flame monitor status information							
Current output [0] 0..20mA [1] 4..20mA	free	Flame	(→) Harmonic detection	Range A[0] / B[1]	Switch difference MC1 or MC2	Frequency	Intensity

**L** D-LX 200,D-LX 720 error information

This register contains the plausible LX200 error information. The original error message from MC1 or MC2 is provided as so-called D-LX 200,D-LX 720 flame monitor error information for this purpose.

Bit7	Bit6	Bit5	Bit4	Bit3	Bit2	Bit1	Bit0
MC identifier*		Error message 0..127					

\*MC identifier  
 0 → MC2 error message  
 1 → MC1 error message

**M** AD value Min/Max RMS

provides the maximum/minimum and the mean(RMS) of the digitized flame sensor raw signal information for the current data record, which is mapped by the 128AD values (cf. Note N)

**N** AD values

These registers contain 128AD values with the digitized flame sensor raw signal information

Register 2069 / 0815		...	Register 2132 / 0854	
R0H	R0L	...	R0H	R0L
AD0	AD1	...	AD126	AD127





---

D-LX 200  
D-LX 720

## Compact Flame Monitor



---

### **9 Maintenance**

- 9.1 Customer service information
- 9.2 Safety
- 9.3 Maintenance intervals
- 9.4 Maintenance tasks
- 9.5 Fault
  - 9.5.1 Error messages
  - 9.5.2 Warning of different switch position
  - 9.5.3 Harmonic detection



## 9 Maintenance

The D-LX 200, D-LX 720 is an easily maintained Compact Flame Monitor. This chapter explains the necessary maintenance tasks, such as visual inspections and cleaning.

### 9.1 Customer service information

If desired the maintenance can also be undertaken by DURAG GmbH. We would be happy to explain the advantages of a maintenance contract for your company. The D-LX 200, D-LX 720 can also be commissioned by DURAG. The electrical installation in-situ must be carried out by approved specialist companies where applicable, and comply with the customary local regulations. Our service addresses and telephone numbers can be found in the Appendix on page 115.

### 9.2 Safety

#### WARNING



#### Danger of electric shock

Once the housing or accidental contact protection have been opened, live parts are accessible. Before working on the device, the mains connection leads must therefore be disconnected from the power and protected against unauthorized re-activation. If the accidental contact protection is removed, it must be replaced before switching on the mains voltage.

#### CAUTION



#### Damage to property by unauthorised personnel

The person responsible for safety must ensure that only qualified (authorised) personnel operate the measuring system described in this Manual. Particular care must be taken to ensure that the warnings on operator protection and measuring system protection specified in this Manual are known and adhered to.

#### CAUTION



#### Damage to electronic components through electrostatic discharge (ESD)

DURAG devices are protected from uncontrolled electrostatic discharge (ESD) during closed operation. If the device is opened (e.g. for service or maintenance works), then suitable ESD protective measures must be undertaken beforehand.

### 9.3 Maintenance intervals

The D-LX 200, D-LX 720 is a low-maintenance Compact Flame Monitor with system-dependent maintenance intervals, which must be defined by the operator. They depend on:

- the dust in the combustion air
- the type of fuel
- the purge air volume
- the general ambient conditions (e.g. climatic conditions at the measuring point)

It is expedient to start with a short maintenance interval initially (typically 4 weeks), and then to gradually extend this to up to 6 months, depending on the conditions.

Independently of this however, a check should be performed every four weeks.

If maintenance of the flame monitor is omitted or is inadequate, failure of the burner must be expected with increased soiling of the lens.

### 9.4 Maintenance tasks

- Check the purge air unit, including the purge air hoses, for damage.
- Check that the hose connections are leak-free and fit securely.
- Check the optics (lens) of the flame monitor for soiling  
Remove visible deposits with oil-free compressed air or with a soft lint-free cloth (optical cleaning cloth or microfibre cloth), using water and alcohol if necessary.  
If soiling is frequently found on the outside of the lens, the purge air volume must be adjusted.



The flame monitor is a type-approved device. Any interventions or modifications will result in loss of the approval. Repairs may only be performed by the manufacturer or his representatives, as only they can verify full functionality following repair, by means of extensive long-term tests and suitable test devices.

### 9.5 Fault

If an error is detected in the safety-relevant software and hardware components during internal self-monitoring of the flame monitor, an error shutdown and internal lockout are triggered. The relays for flame signal and operational readiness drop out and the red "Error" LED in the front panel is constantly illuminated. The yellow "Power" LED starts to flash.

The number of flashes by the yellow LED allow the commissioning engineer / operator to analyse the cause of the error more accurately. The following error sources are indicated:



### 9.5.1 Error messages

#### Error messages on the D-LX 200, D-LX 720:

Yellow LED flashes	Error cause	Possible action
1 x	Synchronisation	
2 x	Switch difference DIP switch	Check switch position; Correct if different
3 x	Switch difference Rotary switch Range A	Check switch position; Correct if different
4 x	Switch difference Rotary switch Range B	Check switch position; Correct if different
5, 6, 7 x	Error in analogue section or extremely erratic flame	Check flame quality and correct burner settings if necessary
8 x or more	Internal error	Note the number of flashing signals; Contact DURAG Service; Probably no repair possible on-site.

Table 9.1: Error messages

Actuation of the reset key above the LEDs acknowledges a device fault and generally permits continuation of the flame monitor function after a restart. All LEDs go out when the reset key is pressed. Reset can also be achieved by temporarily removing the power supply, e.g. by disconnecting the yellow 24V supply cable. This eliminates the need to open the housing cover.

Irrespective of the device status (flame indication ON / OFF or fault), the relays drop out after a mains break or actuation of the reset key and the flame monitor program restarts.



The flame monitor is a type-approved device. Any interventions or modifications will result in loss of the approval. Repairs may only be performed by the manufacturer or his representatives, as only they can verify full functionality following repair, by means of extensive long-term tests and suitable test devices.

### 9.5.2 Warning of different switch position

If the settings for the thresholds or the gain characteristic curve are different for the two channels of the Compact Flame Monitor (also see chapter 6.1 and 6.2), the "Switch Error" LED lights up red on the front panel (see Figure 6.2 on page 55). If the difference persists for longer than 8s, an error shutdown occurs (also see Table 4.1 on page 40).

### 9.5.3 Harmonic detection

The D-LX 200, D-LX 720 can perform a (→) harmonic detection for safety purposes. During this process, the Compact Flame Monitor observes the behaviour of the measured flicker frequency over time. The flicker frequency of a combustion process fluctuates. The measurement of a constant flicker frequency over several seconds, on the other hand, indicates an artificial light source, for example. Harmonic detection guarantees that artificial light sources cannot be classified as flames by the D-LX 200, D-LX 720.

When the D-LX 200, D-LX 720 measures a constant frequency over 10 s, it indicates:

- "Flame OFF"
- "Freq" LED on the front panel flashes
- Flame intensity current output remains constantly at 4 mA / 7.2 mA.

If using the D-LX 200 InformationCentre (Flame Information window):

- the bar for the Flame Intensity remains fixed at 20 %.
- The "Harmonic Frequ." field is active (green).



The harmonic detection is deactivated when the frequency switching threshold is set to 0 (zero).

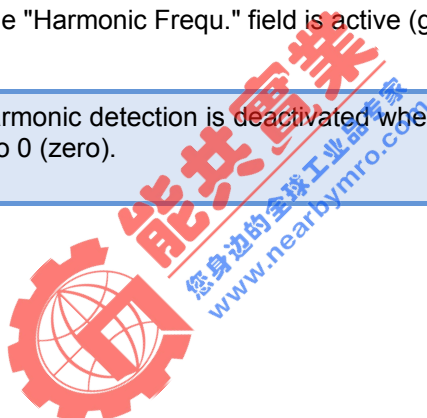

---

D-LX 200  
D-LX 720

## Compact Flame Monitor

# Appendix

<b>10</b>	<b>Technical Data</b>
10.1	Technical data of the basic device
10.2	Factory settings (default)
10.3	Technical data for the integrated flame sensor
10.4	Presettings
<b>11</b>	<b>Plans and Drawings for D-LX 200, D-LX 720</b>
11.1	Wiring diagram D-LX 200, D-LX 720
11.2	Dimensional drawings
<b>12</b>	<b>Declaration of conformity</b>
<b>13</b>	<b>Glossary</b>
<b>14</b>	<b>Index</b>
<b>15</b>	<b>DURAG GROUP company addresses</b>



## 10 Technical Data

### 10.1 Technical data of the basic device

Dimensions (incl. sighting tube and purge air connection)	approx. 80 x 80 x 250 mm
Weight	approx. 1.2 kg
Permissible ambient temperature	-40°C to +85°C
Permissible operating mode	Intermittent operation, continuous operation and 72-hour operation in accordance with (→) TRD 604
Safety time	1 s (2 s, 3 s and 5 s on request)
Electrical connection	2.0m cable 12 x 0.5mm <sup>2</sup> (AWG 22) with complete shielding
Housing	PA, fire-protected in accordance with UL94 V0, blue
Class of protection ( according to EN 60529 )	IP 68 (corresponds to Nema 6)
Power supply	24 VDC ± 20%
Power consumption	Approx. 5 W
Fuse protection	F1= 0.5 A, slow-blow, MST 250 F2= 0.5 A, slow-blow, MST 250
Current output 0/4...20 mA	Flame intensity / Max. load 750 Ohm
Flame contact	Closing contact; active, when Flame ON
Operational readiness contact	Closing contact; active, when no fault (series connection with the flame contact as <i>third shut-off criterion</i> possible.)
Switching capacity of relay contacts	Min: 10 VAC/DC, 10 mA
	Max: at 24 VDC = 0.5 A with spark extinction
Ranges	2 (A and B)
Range selection (B)	24VDC ± 20%, I = approx. 6 mA
Sighting tube connection	G 1¼" female thread · optional: NPT 1¼" female
Purge air connection	G ½" internal thread · optional: NPT ½" female

Table 10.1: Technical data of the basic device



The flame monitor is provided with galvanic isolation between the supply voltage (24 VDC) and the internal voltage. The current output is galvanically connected to the internal voltage.

## 10.2 Factory settings (default)

"Flame intensity" current output	4 - 20 mA
Safety time	1 sec.

**Table 10.2: Factory settings (default)**

If no special specifications are provided with the order, the D-LX 200, D-LX 720 is delivered with the above-specified default settings. These settings may only be changed in the factory and must be noted on the type plate.

## 10.3 Technical data for the integrated flame sensor

Spectral sensitivity	190nm - 520nm 280nm - 410nm 780nm - 1800nm	D-LX 200 UA D-LX 200 UAF D-LX 200 IG
Flame sensor gain	Automatic adjustment	
Optical viewing angle	6°	D-LX 200

**Table 10.3: Technical data for the integrated flame sensor**

## 10.4 Presettings

The switches described in chapter 6 and the Modbus termination are preset as follows at delivery:

Gain characteristic curve	V7
Intensity threshold	0
Flicker frequency threshold	0
Modbus slave address	1
Modbus termination	OFF

**Table 10.4: Presettings**

# 11 Plans and Drawings for D-LX 200, D-LX 720

## 11.1 Wiring diagram D-LX 200, D-LX 720

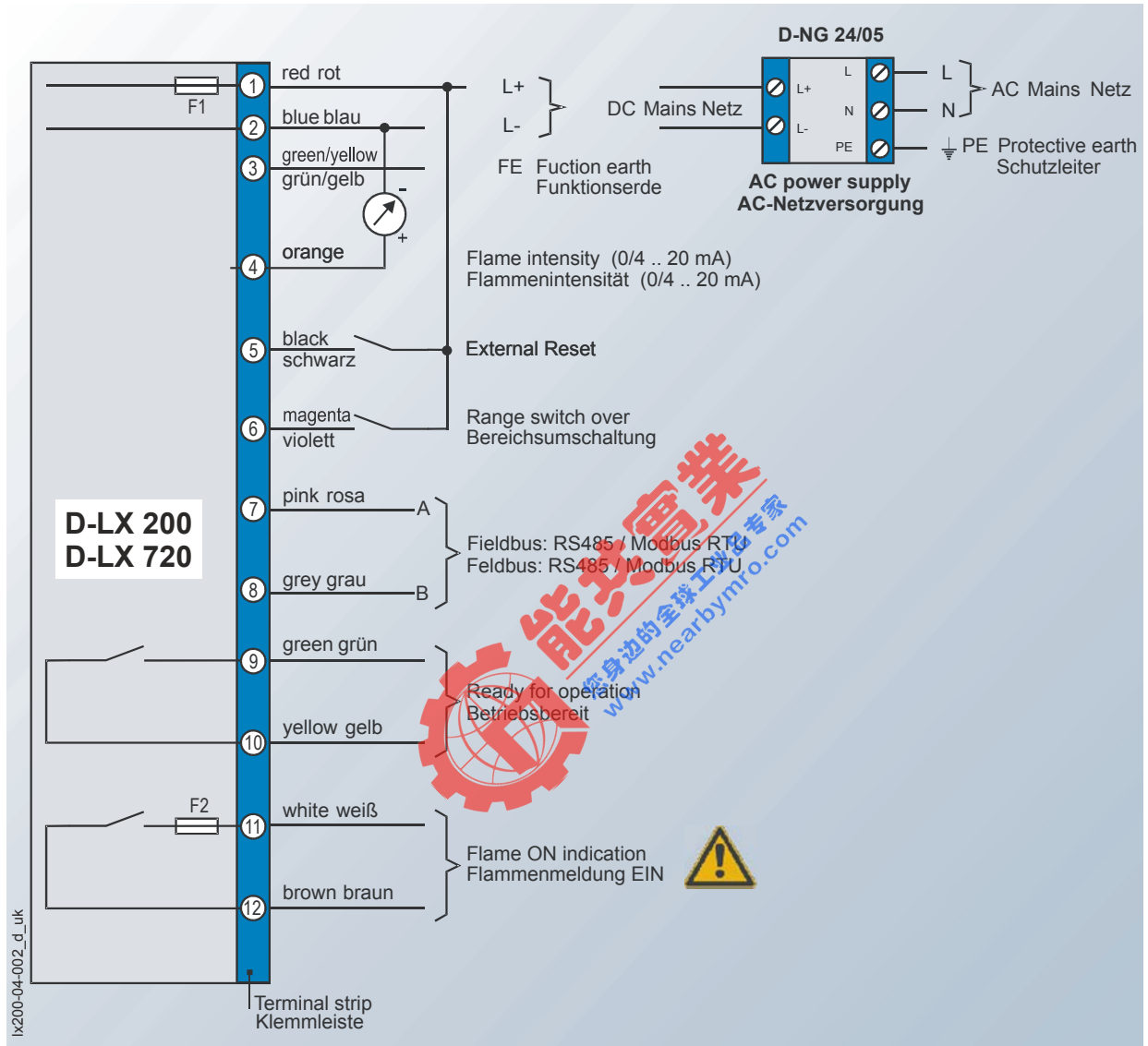

Figure 11.1: Wiring diagram D-LX 200, D-LX 720

**CAUTION**



Only non-reactive components like relay or contactor coils may be operated via an external fuse at the "ready for operation" contact output. These measures provide protection against contact welding in accordance with EN 298.

## 11.2 Dimensional drawings

### 11.2.1 D-LX 200

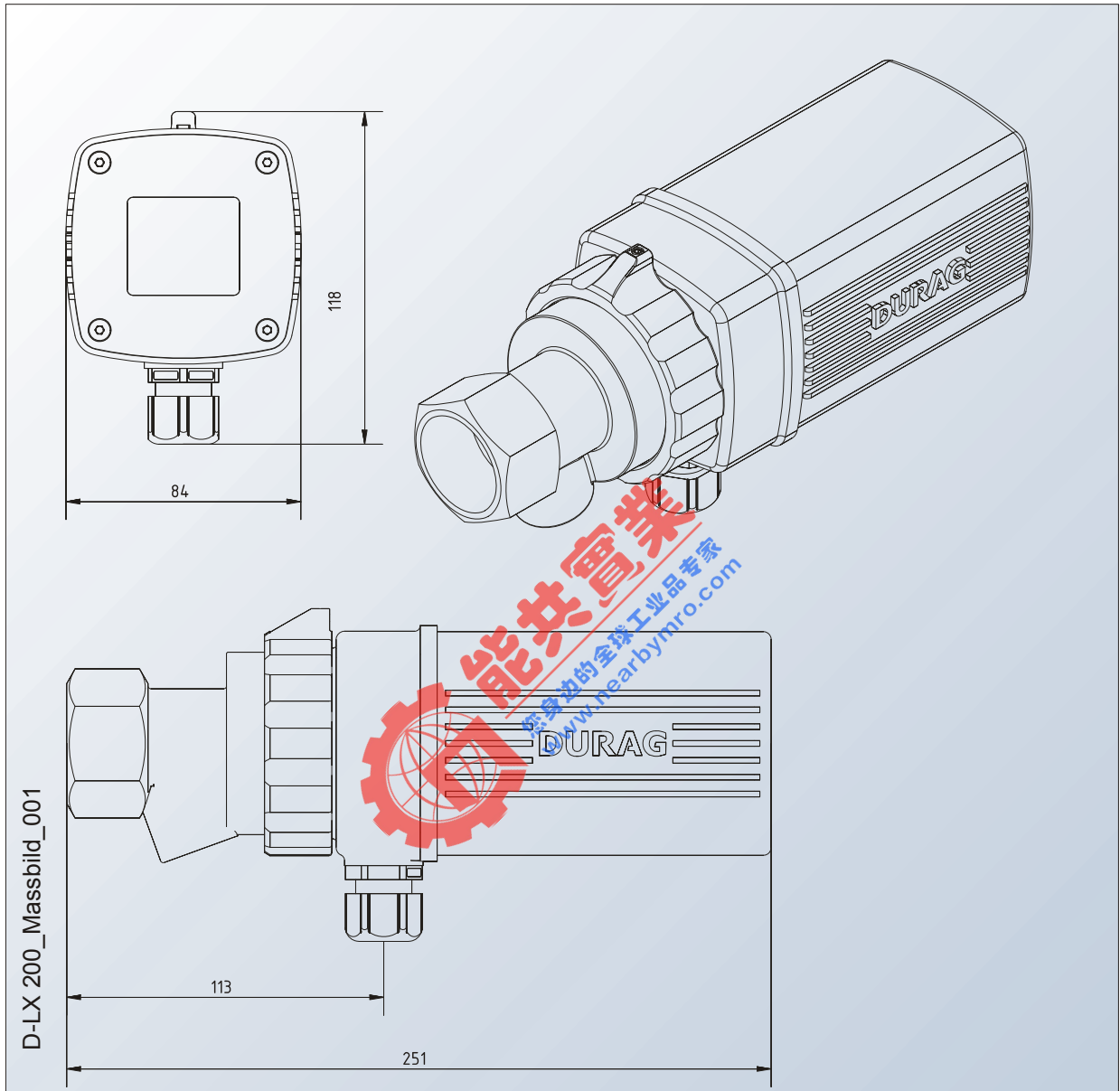

Figure 11.2: Dimensional drawing D-LX 200



11.2.2 D-LX 720

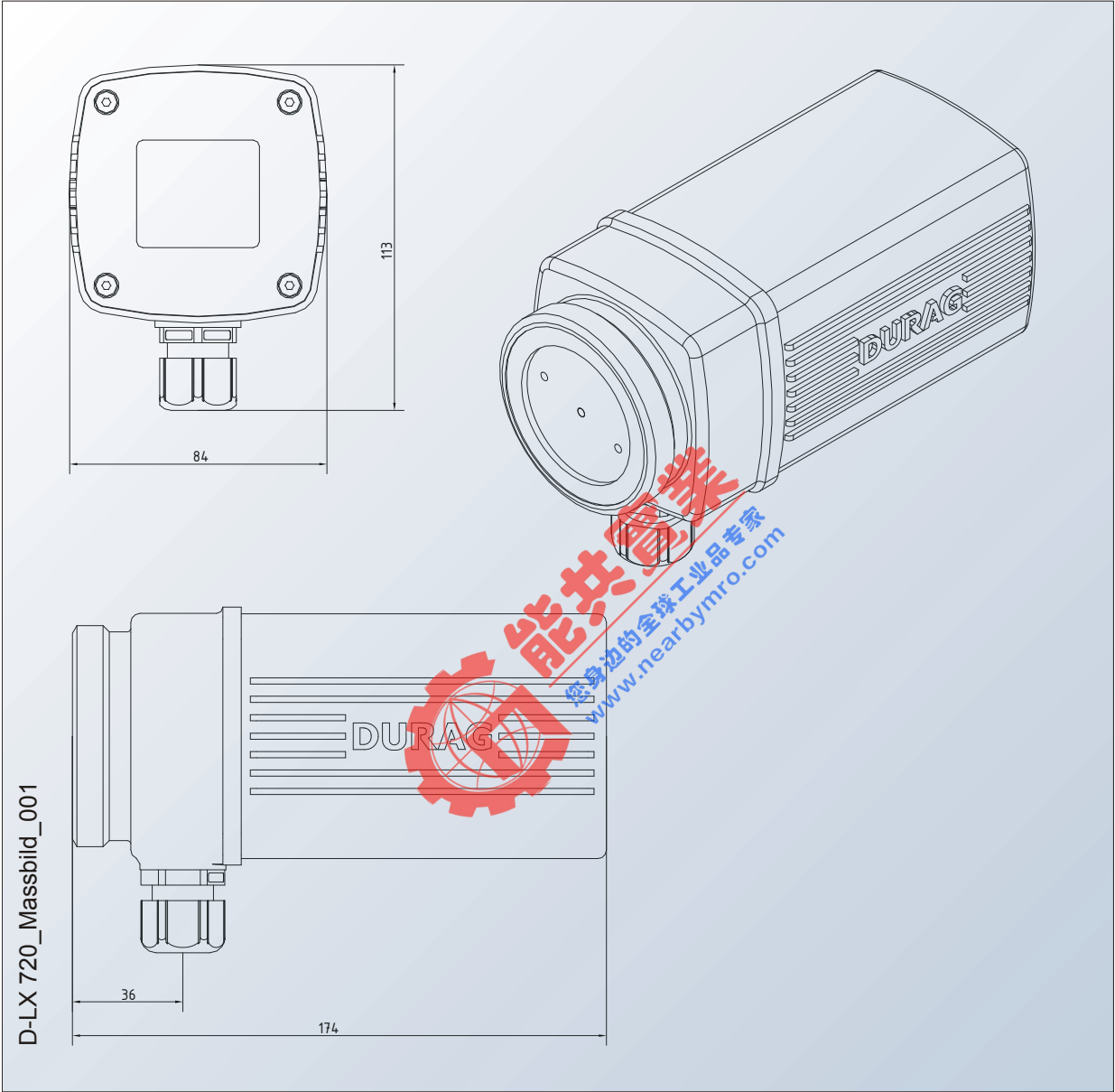

Figure 11.3: Dimensional drawing D-LX 720



**12 Declaration of conformity**

# DURAG

## EG-Konformitätserklärung EC Declaration of Conformity

**Hersteller Manufacturer:**

DURAG GmbH

**Anschrift Address:**

Kollastr. 105, 22453 Hamburg

**Produktbezeichnung Product description:**Compact Flame Monitor **D-LX 200, D-LX 720**  
Compact Flame Monitor **D-LX 200, D-LX 720**

Das bezeichnete Produkt erfüllt die Anforderungen folgender europäischer Normen und Richtlinien, vorausgesetzt, dass es ordnungsgemäß installiert, gewartet und entsprechend seiner Bestimmung eingesetzt wird. Die einschlägigen Vorschriften und Hinweise der Bedienungsanleitung sind zu beachten.

The described product complies with the following provisions of Council Directive, provided that it is installed, maintained and used in applications for which it was made, in accordance with relevant installation standards and manufacturer's instructions.

**EU-Richtlinien:**2004/108/EG (EMV-Richtlinie)  
90/396/EWG (Gasgeräte-Richtlinie)  
94/9/EG (ATEX-Richtlinie)  
2006/95/EG (Niederspannungsrichtlinie)**Directives:**2004/108/EEC (EMC Directive)  
90/396/EEC (Gas Appliance Directive)  
94/9/EEC (ATEX-Directive)  
2006/95/EEC (Low Voltage Directive)**Normen:**EN 55011 A2 (2007)  
EN 298 (2003)  
EN 60730-1 (2002)  
EN 60079-0 (2007)  
EN 230 (2005) ①**Standards:**EN 55011 A2 (2007)  
EN 298 (2003)  
EN 60730-1 (2002)  
EN 60079-0 (2007)  
EN 230 (2005) ①**Funktionale Sicherheit:**

EN 61508-1, -2 -3, -4, -5, -6 und -7 ①

**Functional Safety:**

EN 61508-1, -2 -3, -4, -5, -6 und -7 ①

**Qualitätsmanagement:**DIN EN ISO 9001 (2000) ①  
TÜV NORD CERT GmbH**Quality Management:**DIN EN ISO 9001 (2000) ①  
TÜV NORD CERT GmbH

①: das Gerät erfüllt diese Anforderungen zusätzlich zu den Auflagen der Konformitätserklärung !

①: the device complies with these requirements in addition to the regulations of the declaration of conformity!

**Aussteller Issuer:**

DURAG GmbH

**Ort, Datum Place, date:**

Hamburg, 29.05.2008

**Rechtsverbindliche Unterschrift  
Legally binding Signature**  
ppa. (Norbert Rink)



## 13 Glossary

### Background radiation influence

Radiation from static emitters, like incandescent boiler components, can be modulated by combustion air currents or flue gas plumes. If the measured radiation is in the range of the flame spectrum and in the normal flicker frequency range (approx. 10 to 200 Hz) of a flame, monitoring systems can mistakenly detect a flame signal. Modern flame monitor systems must be able to filter out this "background radiation influence".

### Claus plant (SRU, sulphur recovery unit)

All H<sub>2</sub>S-containing exhaust gases that develop are processed in the Claus plant. The toxic H<sub>2</sub>S is converted into elementary sulphur and water during this process.

### CPU

The **main processor** (*Central Processing Unit*, abbreviated to *CPU*), often also simply referred to as the processor in general usage, is the central processor of a computer, which controls all other components.

**Cyclical communication** Interface communication in which data are bundled into data packets and transferred in a defined order, separated by defined characters (e.g. semicolon).

### Data bus

The **bus** is a frequently used term in data processing for a wiring system for data exchange between potentially more than two nodes.

A bus is a wiring system with associated control components, which serves for the exchange of data and/or energy between hardware components. Bus systems are particularly used inside computers and to connect computers to peripheral devices, but also in the control of machines.

A field bus is an industrial communication system, which connects a multitude of field devices such as probes (sensors), actuating elements and drives (actuators) to a control device. Field bus technology was developed in the 80s, in order to replace the previously standard parallel wiring of binary signals and analogue signal transmission with digital transmission technology.

### DIP switches

are small switches which are used (e.g. on the motherboard or other printed circuit

boards) to perform defined basic settings. The abbreviation stands for dual in-line package, i.e. a configuration with two parallel series of connections.

### Flame intensity

The flame intensity results from the (→) flame signal and offset against the gain settings. It is digitally calculated as a numerical value (from 0 to 2<sup>23</sup>) and output as 0...100%.

### Flame signal

An (analogue) current is generated by the flame in the photodiode and subsequently further processed in the analogue amplifier and analogue filters. This flame signal (AC/DC) is sent to the microcontroller inputs for further digital processing.

### Flame radiation

is the visible and non-visible (IR/UV) light emitted by the flame.

### Harmonic detection

The flicker frequency of a true combustion process fluctuates.

A flicker frequency that remains constant over several seconds can therefore not originate from a flame. This situation is identified and results in an error message after 10 seconds. Also see chapter 9.5.3 on page 98.

### Low-NOx

In this incineration technique, the flame temperature is reduced by recirculating exhaust gases from the combustion chamber, so that the flame is cooled. This results in a considerable reduction in pollutants, particularly nitrogen oxides.

### Modbus (interface communication)

The Modbus protocol is a communication protocol based on a master/slave or client/server architecture. Modbus has become a de facto standard in industry, as it is an open protocol.

A master (e.g. a PC) and several slaves (e.g. measurement and control systems) can be connected by means of Modbus.

### NPT

The National Pipe Thread (NPT thread, NPT pipe thread) in accordance with ASME/ANSI B1.20.1 is a US thread standard for self-sealing screw pipe connections.

The seal is obtained as a result of the

tapered arrangement of the thread. No additional sealant (e.g. Teflon tape, hemp) is required.

The diameters, number of starts and taper angle differ slightly in comparison with the Whitworth pipe thread - also British Standard Pipe (BSP) - so that the two threads cannot be screwed together

**Offset** or adjustment offset

In this manual offset denotes a static value which is added to or subtracted from a measured value, in order to adjust the zero value, for example.

**RJ-45**

Registered jack and the abbreviation RJ in conjunction with a number (e.g. RJ-45) stands for the telephone cables standardised by the US American Federal Communications Commission (FCC) and the connectors and jacks used for this purpose. RJ plug connections are now used worldwide for telephone and network

connections. These connectors are usually used in unison with twisted pair wires.

**RS485 interface**

- analogous to the RS422 interface - has been developed for serial high-speed data transfer over long distances and is becoming increasingly widespread in the industrial sector.

The data cables must be implemented as twisted pairs.

**Safety time**

The safety time is the response time of the flame monitor to an outage of the flame signal and the resulting switch-off of the relay contact for the Flame ON signal.

**TRD 604**

Technical regulations for steam boilers. Operation of steam boiler plants with steam generators in Group IV without constant supervision.



## 14 Index

### A

Approvals 28

### B

Ball-type valve 26  
Basic setting for setting tasks 60  
Basic settings 102

### C

checklist  
    Requirements for operation 50  
Checklist  
    Selection criteria Compact Flame Monitor 28  
Class of protection 46  
Claus plant 109  
Communication, cyclical 109  
Company addresses 115  
Connection  
    Power supply 46  
    Purge air supply 48  
CPU 109

### D

D-LX 200, D-LX 720  
    IG 25  
    UA 25  
    UAF 25  
Data bus 109  
Design variants 25  
Device description  
    D-LX 200 36  
    D-LX 720 36  
Dimensional drawing D-LX 200 104  
Dimensional drawing D-LX 720 105  
DIP switch 65  
    S3 58  
    S4 58  
    S5 85

### E

Elimination of potential isolation 48  
Error

D-LX 200, D-LX 720

Codes for the D-LX 200, D-LX 720 97  
Messages on the D-LX 200, D-LX 720 97

Error messages 77  
Error shutdown 36

### F

Fault 96  
Fields of application 27  
Flame sensor  
    Infrared 35  
    Ultraviolet 34  
Flow chart for settings by means of  
    Current output/LED 61  
    InformationCentre 63  
Front panel D-LX 200 55  
Functional description 33  
Fuse protection 101  
Fuses 46

### G

Gain characteristic curves 57

### H

Harmonic detection 98  
Hazard  
    From electrical equipment 18  
    To the device due to purge air failure 19

### I

InformationCentre  
    AC signal course 73  
    Connection menu 71  
    Data record structure 79  
    Display view 71  
    Display view Flame Information 72  
    Error message 77  
    File menu 75  
    FileSetting submenu 75  
    Front screen 70  
    Submenu AdjustCurrentOutput 76  
    System Settings 74  
Installation  
    D-LX 200, D-LX 720 standard installation 44  
    Software D-LX 200 InformationCentre 69

Installation point, suitable 44  
 Installation, flange 44

## J

Jumper  
   PCB no. 4, X2 84  
 Junction box 26

## L

LEDs, Meaning of 40  
 Location of fuses 46  
 Low-NOx 109  
 Luminous band display 26

## M

Maintenance 95  
   Intervals 96  
   Tasks 96  
 Modbus 109  
   Slave address 59, 84  
 Modbus RTU  
   FunctionCode 86  
   FunctionCode Read Registers Request 86  
   FunctionCode Read Registers Response 86  
   FunctionCode Write Multiple Registers Request 87  
   FunctionCode Write Multiple Registers Response 87  
   Message Frame 85  
   Register and address information 88  
   Register and device-specific address information 89  
   Slave Address Range 85

## N

Notes  
   General tip or information 13  
 Notes on delivery: 25

## P

Personnel, qualified 20  
 Power failure 46  
 Power supply 26  
 Presettings 102  
 Printed circuit board  
   no.2 - DIP switch S5 84  
   no.2 - DIP switches S3 and S4 58  
   no.4 - Jumper X2 84  
   Numbering 54  
 Purge air connection 49

## R

Range 59  
 Range switching 59  
 Reset 97  
 RS485 interface 110

## S

Safety instructions, general 17  
 Safety screw 44  
 Safety time 27, 64, 102  
 Scope of supply 25  
 Selection criteria Compact Flame Monitor 28  
 Self-monitoring 35  
 Setting aid, optical 26  
 Settings 53  
   Flicker frequency of the flame 56  
   Intensity 55  
   optional: 27  
 Special accessories 26  
 Spectral sensitivity 102  
 Switch position, different 97  
 Switching capacity of relay contacts 101  
 Swivel mount 26, 45

## T

Technical data  
   Basic device 101  
   Configuration of inputs and outputs 101  
   Default settings 102  
   Factory settings 102  
   Integrated flame sensor 102  
   Presettings 102  
 Technical Data 101  
 Test light source, combined 26  
 Thermal insulator with potential isolation 26  
 Transport damages 25  
 Tropicalisation of printed circuit boards 26  
 Type approval 17  
 Type plate 30  
 Typographical conventions 12

## U

Use, intended 27  
 Use, proper 20

## V

Viewing position 44



Volume flow depending on the purge air 49

## W

Warnings, gen.

Average risk - Warning 13

High risk - Danger 12

Minor risk - Caution 13

Warnings, meaning. 12

Warnings, spec.

Electric current 13

ESD 13

Explosion 13

General warning sign 13

Hot surface 13

Warranty 30

Wiring diagram 47, 103





**15 DURAG GROUP company addresses****DURAG GmbH**

Kollaustr. 105 ▪ 22453 Hamburg  
Tel. +49 40 55 42 18 – 0 ▪ Fax +49 40 58 41 54  
E-mail: info@durag.de

**DVN – DURAG Vertrieb Nord**

Kollaustr. 105 ▪ 22453 Hamburg  
Tel. +49 40 55 42 18 – 0 ▪ Fax +49 40 58 41 54  
E-mail: dvn@durag.de

**DVO – DURAG Vertrieb Ost**

Meißner Ring 4 ▪ 09599 Freiberg  
Tel. +49 37 31 30 04 – 0 ▪ Fax +49 37 31 30 04 – 22  
E-mail: durag.freiberg@durag.de

**DVS – DURAG Vertrieb Süd**

Weidenweg 16 ▪ 73087 Bad Boll  
Tel. +49 71 64 9 12 25 – 0 ▪ Fax +49 71 64 9 12 25 – 50  
E-mail: info@dvs-badboll.de

**DVW – DURAG Vertrieb West**

An der Pönt 53a ▪ 40885 Ratingen  
Tel. +49 21 02 74 00 – 0 ▪ Fax +49 21 02 74 00 – 28  
E-mail: dvw@durag.de

**DURAG France Sarl**

Parc GIP Paris Charles de Gaulle  
49 rue Léonard de Vinci  
BP 70166  
95691 GOUSSAINVILLE  
France  
Tel. +33 1 30 18 11 80 ▪ Fax +33 1 39 33 83 60  
E-mail: info@durag-france.fr

**DURAG UK Office**

Honeysuckle Cottage  
Ridding Bank  
Stoke-on-Trent  
Staffordshire, ST4 8SB  
Great Britain  
Tel. +44 17 82 65 76 66 ▪ Fax +44 17 82 64 60 20  
E-mail: durag.uk@durag.de

**DURAG, Inc.**

Southridge Business Center,  
1355 Mendota Heights Road,  
Suite 200  
Mendota Heights,  
Minnesota MN 55120  
USA  
Tel. +1 65 14 51 – 17 10 ▪ Fax +1 65 14 57 – 76 84  
E-mail: info@durag.com

**Durag India Instrumentation Private Limited**

#143/16, 4th Main Road,  
Industrial Town, Rajajinagar  
Bangalore 560 044  
India  
Tel.: + 91 80 23 14 56 26 & 23 14 56 27  
Fax: + 91 80 23 14 56 26 & 23 14 56 27 Extn. 30  
E-mail: info@duragindia.com



