

Operator Manual



370A Programmable Curve Tracer

070-7779-05

Please check for change information at the rear
of this manual.

First Printing: January 1989



Instrument Serial Numbers

Each instrument manufactured by Tektronix has a serial number on a panel insert or tag, or stamped on the chassis. The first letter in the serial number designates the country of manufacture. The last five digits of the serial number are assigned sequentially and are unique to each instrument. Those manufactured in the United States have six unique digits. The country of manufacture is identified as follows:

B010000	Tektronix, Inc., Beaverton, Oregon, USA
E200000	Tektronix United Kingdom, Ltd., London
J300000	Sony/Tektronix, Japan
H700000	Tektronix Holland, NV, Heerenveen, The Netherlands

Instruments manufactured for Tektronix by external vendors outside the United States are assigned a two digit alpha code to identify the country of manufacture (e.g., JP for Japan, HK for Hong Kong, IL for Israel, etc.).

Tektronix, Inc., P.O. Box 500, Beaverton, OR 97077

Sony/Tektronix Corporation, 5-9-31 Kitashinagawa, Shinagawa-ku, Tokyo 141-0001 Japan

Printed in Japan

Copyright © Sony/Tektronix Corporation, 1989. All rights reserved.

Copyright © Tektronix, Inc., 1989. All rights reserved. Tektronix products are covered by U.S. and foreign patents, issued and pending. The following are registered trademarks: TEKTRONIX, TEK, TEKPROBE, and SCOPE-MOBILE.

Microsoft is a registered trademark of Microsoft Corporation.

IBM is a registered trademark of International Business Machines.

GPIB-PCII, GPIB-PCIIA, AT-GPIB, and MC-GPIB are registered trademarks of National Instruments Corporation.

WARRANTY

Tektronix warrants that this product will be free from defects in materials and workmanship for a period of one (1) year from the date of shipment. If any such product proves defective during this warranty period, Tektronix, at its option, either will repair the defective product without charge for parts and labor, or will provide a replacement in exchange for the defective product.

In order to obtain service under this warranty, Customer must notify Tektronix of the defect before the expiration of the warranty period and make suitable arrangements for the performance of service. Customer shall be responsible for packaging and shipping the defective product to the service center designated by Tektronix, with shipping charges prepaid. Tektronix shall pay for the return of the product to Customer if the shipment is to a location within the country in which the Tektronix service center is located. Customer shall be responsible for paying all shipping charges, duties, taxes, and any other charges for products returned to any other locations.

This warranty shall not apply to any defect, failure or damage caused by improper use or improper or inadequate maintenance and care. Tektronix shall not be obligated to furnish service under this warranty a) to repair damage resulting from attempts by personnel other than Tektronix representatives to install, repair or service the product; b) to repair damage resulting from improper use or connection to incompatible equipment; or c) to service a product that has been modified or integrated with other products when the effect of such modification or integration increases the time or difficulty of servicing the product.

THIS WARRANTY IS GIVEN BY TEKTRONIX WITH RESPECT TO THIS PRODUCT IN LIEU OF ANY OTHER WARRANTIES, EXPRESSED OR IMPLIED. TEKTRONIX AND ITS VENDORS DISCLAIM ANY IMPLIED WARRANTIES OF MERCHANTABILITY OR FITNESS FOR A PARTICULAR PURPOSE. TEKTRONIX' RESPONSIBILITY TO REPAIR OR REPLACE DEFECTIVE PRODUCTS IS THE SOLE AND EXCLUSIVE REMEDY PROVIDED TO THE CUSTOMER FOR BREACH OF THIS WARRANTY. TEKTRONIX AND ITS VENDORS WILL NOT BE LIABLE FOR ANY INDIRECT, SPECIAL, INCIDENTAL, OR CONSEQUENTIAL DAMAGES IRRESPECTIVE OF WHETHER TEKTRONIX OR THE VENDOR HAS ADVANCE NOTICE OF THE POSSIBILITY OF SUCH DAMAGES.

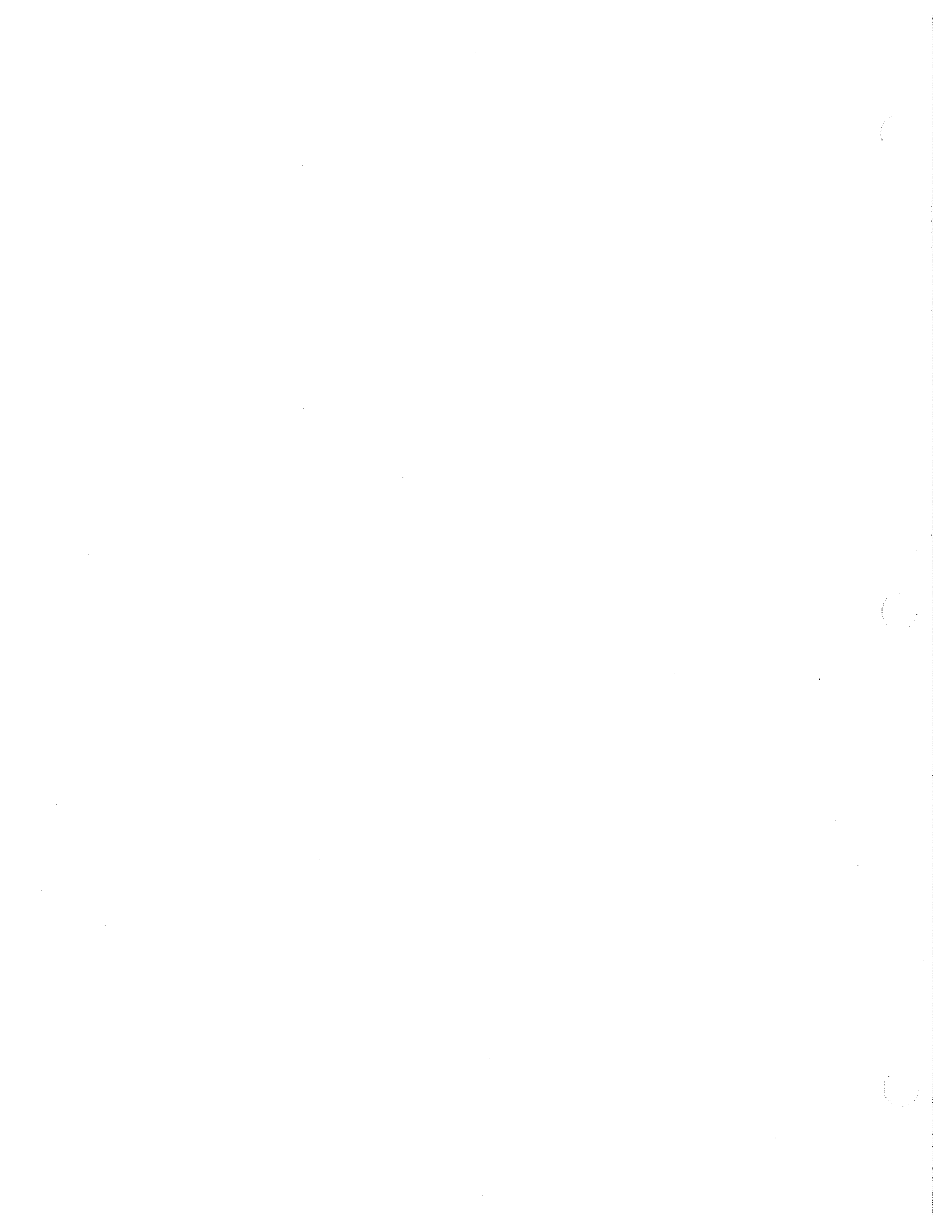



EC Declaration of Conformity

We

Tektronix Holland N.V.
Marktweg 73A
8444 AB Heerenveen
The Netherlands

declare under sole responsibility that the

370A Programmable Curve Tracer

meets the intent of Directive 89/336/EEC for Electromagnetic Compatibility. Compliance was demonstrated to the following specifications as listed in the official Journal of the European Communities:

EN 55011 Class B Radiated and Conducted Emissions

EN 50081-1 Emissions:

EN 60555-2 AC Power Line Harmonic Emissions

EN 50082-1 Immunity:

IEC 801-2 Electrostatic Discharge Immunity

IEC 801-3 RF Electromagnetic Field Immunity

IEC 801-4 Electrical Fast Transient/Burst Immunity

IEC 801-5 Power Line Surge Immunity

Safety Summary

The Safety Summary is a listing of all safety precautions in the manual. These precautions are gathered here in a single place for convenient review of all precautions, and each also appears at a place in the manual where the reader receives the most benefit from the precaution.

TERMS

IN THIS MANUAL

CAUTION statements identify conditions or practices that could result in damage to the equipment or other property.

WARNING statements identify conditions or practices that could result in personal injury or loss of life.

AS MARKED ON EQUIPMENT

CAUTION indicates a personal injury hazard not immediately accessible as one reads the marking, or a hazard to property including the equipment itself.

DANGER indicates a personal injury hazard immediately accessible as one reads the marking.

SYMBOLS

IN THIS MANUAL



This symbol indicates where applicable cautionary or other information is to be found.

AS MARKED ON EQUIPMENT



DANGER—High voltage



Protective ground (earth) terminal



ATTENTION—refer to manual

WARNING

This instrument operates from a single-phase power source, and has a detachable three-wire power cord with a two-pole, three-terminal grounding-type plug. The voltage to ground (earth) from either pole of the power source must not exceed the maximum rated operating voltage (250 volts rms).

Before making connection to the power source, make sure that the instrument is set for the power source voltage, and is equipped with a suitable plug (two-pole, three-terminal, grounding type).

This instrument is safety class 1 equipment (IEC* designation). All accessible conductive parts are directly connected through the grounding conductor of the power cord to the grounding contact of the power plug. Therefore, the power plug must only be inserted in a mating receptacle with a grounding contact. Do not defeat the grounding connection. Any interruption of the grounding connection can create an electric shock hazard.

For electric shock protection, connect the instrument to ground before connecting to the instrument input or output terminals.

*International Electrotechnical Commission.

WARNING

Following use of the 370A at high power settings, the device, fixture, or protective cover may be hot enough to cause injury. Avoid touching any of these items until cooled.

Dangerous voltage may appear at the front-panel collector and base terminals. To avoid injury or equipment damage, do not remove the protective cover.

If a device to be tested does not fit under the plastic protective cover, external test fixturing may be required. Refer construction of external test fixturing to a qualified service technician. Refer also to the service manual for information.

The 370A weighs more than 75 lbs. To avoid personal injury, use care when lifting the instrument, and where required, seek help in lifting and positioning the instrument in the rack. Once the 370A is installed in a rack, use care that the extended 370A does not tip the rack forward, causing personal injury or instrument damage.

CAUTION

CAUTION is used where, if ignored, damage to the instrument or instrument software could result.

To prevent damage to the instrument, always check the settings of the **LINE VOLTAGE SELECTOR** switches located on the rear panel of the 370A before connecting the instrument to the line-voltage source.

Double-wide test adapters are designed to fit in the left set of adapter connectors. If you try to forcibly install a double-wide test adapter in the right side, you might damage the connector. The connectors are identified by the following numbers:

- A1006
- A1007
- A1008
- A1009
- A1010
- A1023

Formatting a disk destroys all data stored on the disk. Make sure you no longer need this data before you format the disk.

Do not remove a disk while the disk drive indicator is on. The light indicates that the disk is currently in operation. Removing a disk halts the operation in progress, and could damage or destroy data on the disk.

Use particular care when displaying a spot. A high-intensity spot may burn the CRT phosphor and cause permanent damage to the CRT.

Certificate of the Manufacturer/Importer

We hereby certify that the 370A Curve Tracer and all installed options comply with the RF Interference Suppression requirements of Amtsbl.-Vfg 1046/1984.

The German Postal Service was notified that the equipment is being marketed.

The German Postal Service has the right to re-test the series and to verify that it complies.

SONY/TEKTRONIX

Bescheinigung des Herstellers/Importeurs

Hiermit wird bescheinigt, daß der/die/das 370A Curve Tracer and all installed options in Uebereinstimmung mit den Bestimmungen der Amtsblatt-Verfugung 1046/1984 funkentstoert ist.

Der Deutschen Bundespost wurde das Inverkehrbringen dieses Geraetes angezeigt und die Berechtigung zur Ueberprufung der Serie auf Einhalten der Bestimmungen eingeraeumt.

SONY/TEKTRONIX

NOTICE to the user/operator:

The German Postal Service requires that systems assembled by the operator/user of this instrument must also comply with Postal Regulation, Vfg. 1046/1984, Par. 2, Sect. 1.

HINWEIS fuer den Benutzer/Betreiber:

Die vom Betreiber zusammengestellte Anlage, innerhalb derer dies Geraet eingesetzt wird, muß ebenfalls den Voraussetzungen nach Par. 2, Ziff. 1 der Vfg. 1046/1984 genugen.

NOTICE to the user/operator:

The German Postal Service requires that this equipment, when used in a test setup, may only be operated if the requirements of Postal Regulation, Vfg. 1046/1984, Par. 2, Sect. 1.7.1 are complied with.

HINWEIS fuer den Benutzer/Betreiber:

Dies Geraet darf in Meßaufbauten nur betrieben werden, wenn die Voraussetzungen des Par. 2, Ziff. 1.7.1 der Vfg. 1046/1984 eingehalten werden.

Contents

i	Safety Summary
iii	Certificate of the Manufacturer/Importer

Section 1 General Information

1	Description
2	Installation
2	Initial Inspection
2	Power Source Information
2	Operating Voltage Selection and Line Fuse Verification
2	Power Cord Information
4	Operating Temperature
4	Test Adapter and Protective Cover
4-1	Kelvin Sense
5	Rackmounting Information
9	Repackaging for Shipment
9	Specification
9	Performance Conditions
28	Accessories
28	Standard Accessories
28	Optional Accessories

Section 2 Controls, Indicators and Connectors

1	Introduction
1	Front Panel
2	Instrument Power and CRT Controls
3	Measurement, ACQ Mode (Store Mode), and Mag Controls
5	Memory Index and Setup Controls
7	Display controls
10	Cursor Controls and Position Controls
12	Step Generator Controls
14	Collector Supply Controls
17	Aux Supply Controls, GPIB Controls, FAST/SHIFT, and Floppy Disk Drive
20	Signal Output Controls and Connectors, Configuration Controls and Indicators, and Input Connector
22	Rear Panel
23	Readout Display

Section 3 Operating Instructions

- 1 **General Description of Instrument Operation**
- 2 **First Time Operation**
- 2 Power on Diagnostics
- 3 CRT and Readout Controls
- 3 Positioning Controls
- 4 Vertical and Horizontal Sensitivity
- 5 Collector Supply
- 7 Display Offset and Magnifier
- 7 Step Generator
- 11 Configuration
- 13 Text Editing
- 13 ACQ Mode (STORE Mode)
- 14 Floppy Disk Drive
- 15 Plotter Output
- 15 Erasing the non-volatile IC memory
- 16 **General Operating Information**
- 16 CRT
- 16 Readout
- 16 Intensity
- 16 Focus
- 16 Vertical Measurement and Deflection Factor
- 17 Horizontal Measurement and Deflection Factor
- 18 Measurements
- 19 Measurement Modes
- 20 Collector Supply
- 22 Interlock System
- 22 Step Generator
- 23 Front-Panel Terminals
- 24 Polarities of the Collector Supply and Step Generator Output
- 25 Digital Storage and Mass Storage System
- 25 Acquisition Modes
- 25 Mass Storage
- 25 Saving in Store and View Mode
- 26 Using the REF Curve
- 26 Saving and Recalling Front-Panel Setting
- 26 Handling a Floppy Disk
- 26 Formatting A Disk
- 27 Directory Display
- 28 Data Files
- 28 Non Store Mode
- 28 Cursors
- 29 Text Editing

- 30 **Measurement Examples**
- 30 Bipolar Transistors
- 33 Field Effect Transistors
- 34 Silicon Controlled Rectifiers
- 35 Signal Diodes and Rectifying diodes
- 36 Zener Diodes ZENER DIODES

Section 4 GPIB

- 1 **Review**
- 1 Hardware
- 1 Communication Protocol
- 4 **Interface Capabilities**
- 4 Interface Messages
- 5 Device-Dependent Messages
- 6 **Setup**
- 6 Configuration Switch Settings
- 7 Connecting the GPIB Cable
- 8 Powering Up
- 8 **Controlling the 370A over the Bus**
- 8 Sending Commands to the 370A
- 9 Sending Queries and Receiving Responses
- 10 Instrument Setup Over the Bus
- 11 Data Storage and Transfer
- 12 Moving Waveform Data to the Controller
- 13 Loading Data from the Controller
- 13 Transferring Other Types of Data
- 13 Summary of Data Transfers
- 15 **Device Dependent Message Format**
- 15 Command Message Formats
- 19 **370A GPIB Commands**
- 19 Introduction
- 19 Front-Panel Control Commands and Queries
- 20 Display Data and CRT Readout I/O Commands and Queries
- 21 System Commands and Queries
- 22 Command List

- 37 **Service Requests**
- 37 Handling Service Requests
- 37 Masking Service Requests
- 38 Status Bytes
- 39 Event Codes

Section 5 Options

Appendix A Diagnostic Routines and Messages

- 1 **Diagnostic Routines**
- 1 Power-on Diagnostic Routines
- 2 User Initiated Diagnostic Routine
- 4 GPIB Diagnostic Routine

- 5 **Messages**

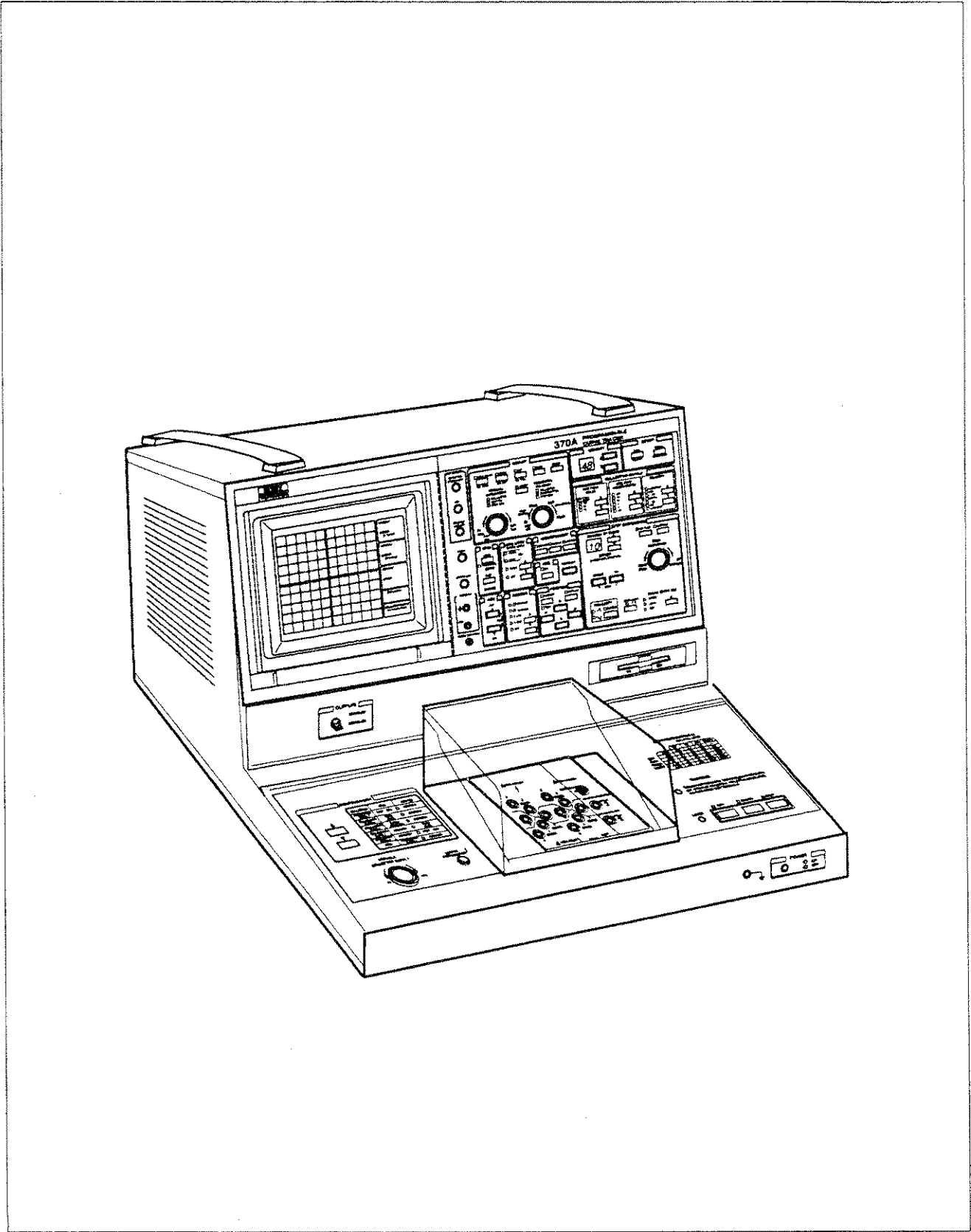

370A Programmable Curve Tracer

Section 1

General Information

1

General Information

■ DESCRIPTION

The 370A is a high-performance, GPIB-programmable digital-storage curve tracer that provides static and dynamic semiconductor device measurements. The instrument stimulates, measures, and displays the semiconductor characteristics of a variety of two-, three-, and four-terminal devices; including bipolar transistors, field effect transistors, silicon-controlled rectifiers, diodes, thyristors, opto-isolators, wafers, and integrated circuits. A variety of measurements can be performed using either grounded-emitter or grounded-base configurations.

The collector supply produces ac, rectified ac, or dc voltages ranging from 0 to ± 2000 volts. This high voltage, combined with a current sensitivity of 100 pA/div, permits extended breakdown measurements on a device under test (DUT). A step generator produces voltage or current steps of either polarity for application to the base or emitter terminal. The step generator may also be operated in a pulsed mode to reduce DUT power dissipation.

In addition to conventional curve tracer performance, the 370A includes the following features:

- Digital storage capability that allows a bright and stable display and cursor measurements. The 370A has a mass storage system that consists of non-volatile IC memory and a 3.5-inch floppy disk drive. Up to 64 families of characteristic curves and front-panel setups can be stored on disk. And up to

9 families of characteristic curves and front-panel setups can be stored in internal non-volatile IC memory. The stored characteristic curves can be recalled for additional analysis and comparison.

- Two extended acquisition modes: Averaging and Envelope. Averaging reduces display noise in high sensitivity ranges. Envelope mode displays the maximum and minimum vertical or horizontal excursion of each curve, which is useful for detecting long-term variations such as thermal drift.

- Nearly all front-panel functions can be controlled via GPIB. (Controls intended for manual operation, such as INTENSITY, FOCUS, GRAT ILLUM, etc. are the only exception.) Also, curve data can be sent, or received, from an external controller through the GPIB.

- The plotter interface permits sending displayed curve data and digital on-screen readouts to a digital plotter without an external controller.

- Other features include an auxiliary voltage supply, cursor measurement readout, and diagnostic routines.

■ INSTALLATION

Initial Inspection

This instrument was thoroughly inspected for mechanical and electrical defects before shipment. It should be free of marks or scratches and meet or exceed all electrical specifications. To confirm this, inspect the instrument for physical damage incurred in transit and test the electrical performance by following the First Time Operation instructions in Section 3, Operating Instructions. For a complete verification of instrument performance, refer a qualified service technician to the Performance Check section of the Service Manual. If a discrepancy is found, contact your local Tektronix Field Office or representative.

Power Source Information

This instrument operates from a power source having a neutral or near ground (earth) potential. It is not intended for operation from two phases of a multi-phase system, nor across legs of a single-phase, three wire system. This instrument can be operated from either a 115-volt or 230-volt nominal supply source, 48 to 63 Hz. Table 1-1 is a listing of the line voltage ranges, line frequency range, and power consumption.

Table 1-1
Line voltage ranges

RANGE switch	NOMINAL switch	
	115VAC	230VAC
HIGH	107VAC-132VAC	214VAC-250VAC
LOW	90VAC-110VAC	180VAC-220VAC
Power consumption		
Max.	400W, 3.5A at 132V 60 Hz	
Typical	120W, 1.3A at 115V 50 Hz	

Operating Voltage Selection and Line Fuse Verification

The LINE VOLTAGE SELECTOR switches (NOMINAL and RANGE, located on the rear panel) allow selection of the operating line voltage. To select the correct operating line voltage:

1. Disconnect the 370A from the ac power source before changing the operating voltage.
2. Select the nominal ac power-source voltage with the NOMINAL switch, and
3. Select the operating line voltage with the RANGE switch.

CAUTION

To prevent damage to the instrument, always check the settings of the LINE VOLTAGE SELECTOR switches located on the rear panel of the 370A before connecting the instrument to the line-voltage source.

To verify that the power-input fuse is for the nominal ac source voltage selected, perform the following:

1. Use the small straight-slot screwdriver to pry the cap (with the attached fuse inside) out of the fuse holder.
2. Verify proper fuse value:

Nominal voltage 230 V	2 A medium blow
Nominal voltage 115 V	4 A medium blow
3. Install the proper fuse and reinstall the fuse-holder cap.



Power Cord Information

A power cord with the appropriate plug configuration is supplied with each instrument. The color-coding of the power cord conductors appears in Table 1-2. Also, should you require a power-cord plug other than that supplied, refer to Table 1-3, Power-Cord and Plug Identification.

Table 1-2
Power-Cord Color Conductor Identification

Conductor	Color	Alternate
Ungrounded (Line)	Brown	Black
Grounded (Neutral)	Light Blue	White
Grounded (Protective Ground)	Green/Yellow	Green/Yellow

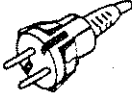
Table 1-3
Power-Cord and Plug Identification Information

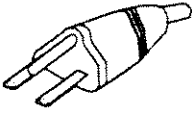
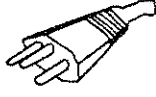
Plug Configuration	Usage	Nominal Line Voltage (AC)	Reference Standards	Option #
	North American 120V/15A	120 V	ANSI C73.11 NEMA 5-15-P IEC 83	Standard
	Universal Euro 220V/16A	240 V	CEE(7),II,IV,VII IEC83	A1
	UK 240V/13A	240 V	BS 1363 IEC 83	A2
	Australian 240V/10A	240 V	AS C112	A3
	North American 240V/15A	240 V	ANSI C73.20 NEMA 6-15-P IEC 83	A4
	Switzerland 220V/10A	220 V	SEV	A5

ANSI - American National Standards Institute
 NEMA - National Electrical Manufacturer's Association
 IEC - International Electrotechnical Commission
 CEE - International Commission on Rules for the Approval of Electrical Equipment
 BS - British Standards Institution
 AS - Standards Association of Australia
 SEV - Schweizerischer Electrotechischer Verein

WARNING

This instrument operates from a single-phase power source, and has a detachable three-wire power cord with a two-pole, three-terminal grounding-type plug. The voltage to ground (earth) from either pole of the power source must not exceed the maximum rated operating voltage (250 volts rms).

Before making connection to the power source, make sure that the instrument is set for the power source voltage, and is equipped with a suitable plug (two-pole, three-terminal, grounding type).

This instrument is safety class 1 equipment (IEC* designation). All accessible conductive parts are directly connected through the grounding conductor of the power cord to the grounding contact of the power plug. Therefore, the power plug must only be inserted in a mating receptacle with a grounding contact. Do not defeat the grounding connection. Any interruption of the grounding connection can create an electric shock hazard.

For electric shock protection, connect the instrument to ground before connecting to the instrument input or output terminals.

*International Electrotechnical Commission.

WARNING

Following use of the 370A at high power settings, the device, fixture, or protective cover may be hot enough to cause injury. Avoid touching any of these items until cooled.

Test adapter and Protective cover

To use the 370A to display and measure the characteristic curves of most devices, a test adapter and the protective cover must be installed. Four test adapters are provided as standard accessories. Six other test adapters are available as optional accessories. The test adapter is inserted into the adapter connectors provided on the front panel. These connectors allow two devices to be set up at a time.

WARNING

Dangerous voltage may appear at the front-panel collector and base terminals. To avoid injury or equipment damage, do not remove the protective cover.

CAUTION

Double-wide test adapters are designed to fit in the left set of adapter connectors. If you try to forcibly install a double-wide test adapter in the right side, you might damage the connector. The connectors are identified by the following numbers:

A1006

A1007

A1008

A1009

A1010

Operating Temperature

The 370A can be operated where the ambient air temperature is between +10° C and +40° C and can be stored in ambient temperatures from -40° C to +65° C. After storage at temperatures outside the operating limits, allow the chassis temperature to reach the safe operating limits before applying power.

The 370A is cooled by air drawn in through the air filter on the rear panel and blown out through holes in the side panels. For proper instrument cooling, provide adequate clearance on the rear and sides of the instrument to ensure free air flow and dissipation of heat away from the instrument.

Kelvin Sense

The 370A provides the adaptor connector equipped with Kelvin sense terminals.

The Kelvin sense is the way to measure voltage with two independent terminals connecting to each of DUT leads; the Force terminal that supplies power and the Sense terminal senses the voltage. By using the Kelvin sense mechanism, you can make a high-precision measurement because that the effect of conductance from the contact between the cables and DUT leads is suppressed to a minimum.

The Sense terminals in the 370A adaptor connector and the A1001 through A1005 test adaptors are for Kelvin sensing. The measurement can be performed without Sense terminals, however, if you need high-precision measurement, use the those terminals.

Connections for Kelvin Sensing

When a DUT does not fit in any of the test adaptors and you prepare a specific test adaptor, for example, use cables to connect terminals and DUT leads as shown in Figure 1-0 for Kelvin sensing.



CAUTION. *Confirm that the the DUT leads and the force terminals: C, B and E are firmly connected. Making improper connections may cause the DUT to be broken. Before a measurement, also verify that the cables are not down and the contact between the terminals and cables are made properly.*

To avoid electric shock and damage to the instrument, perform measurement only within the protective cover. Do not disable the interlock mechanism and/or do not take the cables out of the protective cover to perform measurement without or outside the cover.

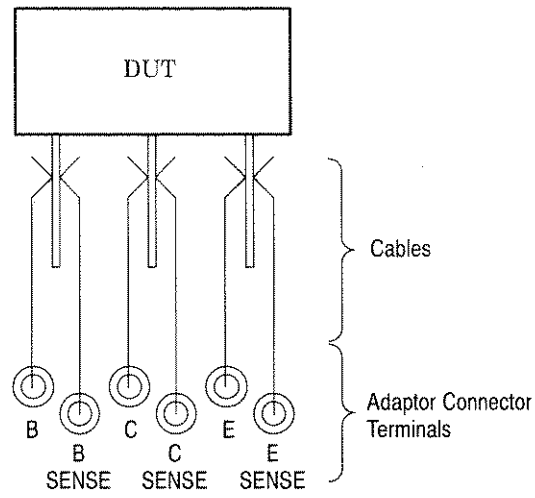

Figure 1-0: Example for Kelvin sense connection

Rackmounting Information

Latching. The 370A incorporates a spring-latch design built into the rackmounting ear. To release, pull the rackmount latch release (see Figure 1-1). To re-latch, push the rackmount latch release until the spring latches engage.

For those applications that require additional rackmounting security, the rackmounting ears of the 370A are drilled for screw fasteners (see Figure 1-1).

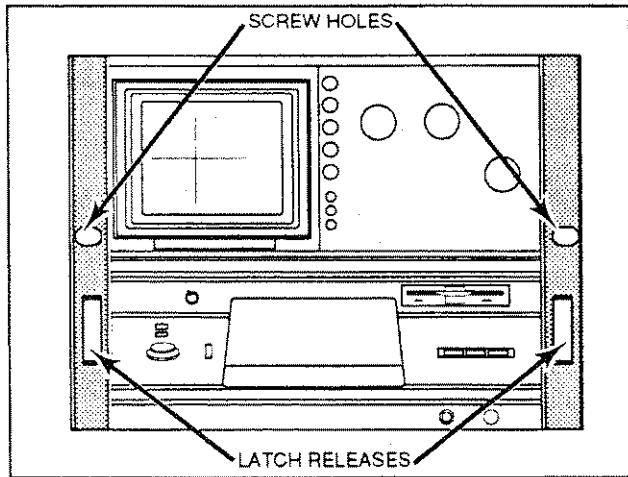

Figure 1-1. Location of the Rackmount Latch Release.

Rackmounting. The 370A fits most commercial consoles and 19-inch racks with rail holes that conform to universal spacing. See Figure 1-2 for hole spacing details.

WARNING

The 370A weighs more than 75 lbs. To avoid personal injury, use care when lifting the instrument, and where required, seek help in lifting and positioning the 370A into the rack. Once the 370A is installed in a rack, use care that when extended, the 370A does not tip the rack forward, causing personal injury or instrument damage.

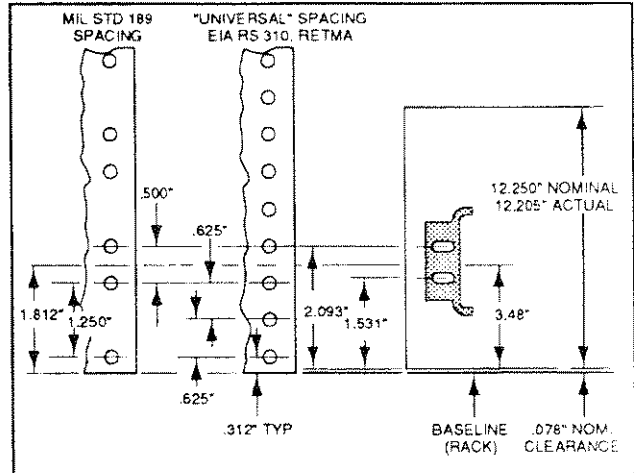

Figure 1-2. Rackmount hole spacing.

When rackmounting the 370A, take note of the following: Allow one inch clearance above and below, and on the left and right sides of the 370A for air circulation. Allow at least three inches of clearance between the 370A rear panel and the rack enclosure for adequate cooling air and to provide cable clearance. The depth of the 370A from behind the rack ears to the rear panel is 18.9 inches. The rack depth must be at least 22 inches (see Figure 1-3) to meet the rear clearance requirement.

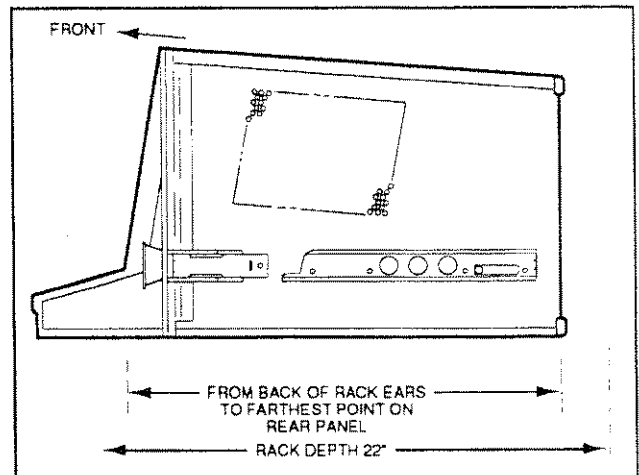

Figure 1-3. Rackmounting Length and Clearance.

370A Operator's Manual

The 370A is 12.25 inches high, a multiple of 1.75 inches (the standard rack spacing). If the 370A is installed in a rack with standard hole spacing, and positioned some multiple of 1.75 inches from the bottom or top, all holes should line up and no drilling should be required.

The slide-out tracks mount easily to the rack front and rear vertical mounting rails if the inside distance between the rails is within 19.8 to 26.5 inches. If the tracks are to be installed in a rack having other dimensions, provide extra support (for example, extensions to the rear mounting brackets) for the rear ends of the slide-out tracks.

The front rack rails must be at least 17 inches apart. The front lip of the stationary-track section mounts in front of the rail. (Use bar nuts behind untapped front rails.) The front lip of the stationary track section must mount in front of the front rail to allow the 370A spring latch to function properly.

The slide-out tracks consist of two assemblies, one for each side of the instrument. Each assembly consists of three sections (see Figure 1-4). The stationary section of each track attaches to rack rails as shown in Figure 1-5. The chassis section mounts on the instrument and is installed at the factory. The intermediate section fits between the other two sections, allowing the instrument to be fully extended out of the rack.

The stationary and intermediate sections for both sides are shipped as a matched set and should not be separated. The package includes matched sets for both sides and mounting hardware. To identify the assemblies, note that the automatic latch and intermediate section latch stop holes are located near the top when the matched sets are properly mated to the chassis sections.

To mount the instrument in a rack, perform the following:

1. Select the appropriate holes in the rack rail, using Figure 1-2 as a guide.
2. Mount the stationary-track sections to the front rack rails with truss head screws (and bar nuts, if necessary).
3. Mount the stationary-track sections to the rear rails, using one of the methods depicted in Figure 1-5. Note that the rear mounting bracket can be installed to fit either deep or shallow cabinet racks.
4. After mounting the instrument in the slide-out tracks, adjust for proper width by loosening the front and rear screws and allowing the slides to seek the proper width. Center the instrument, then tighten the screws.

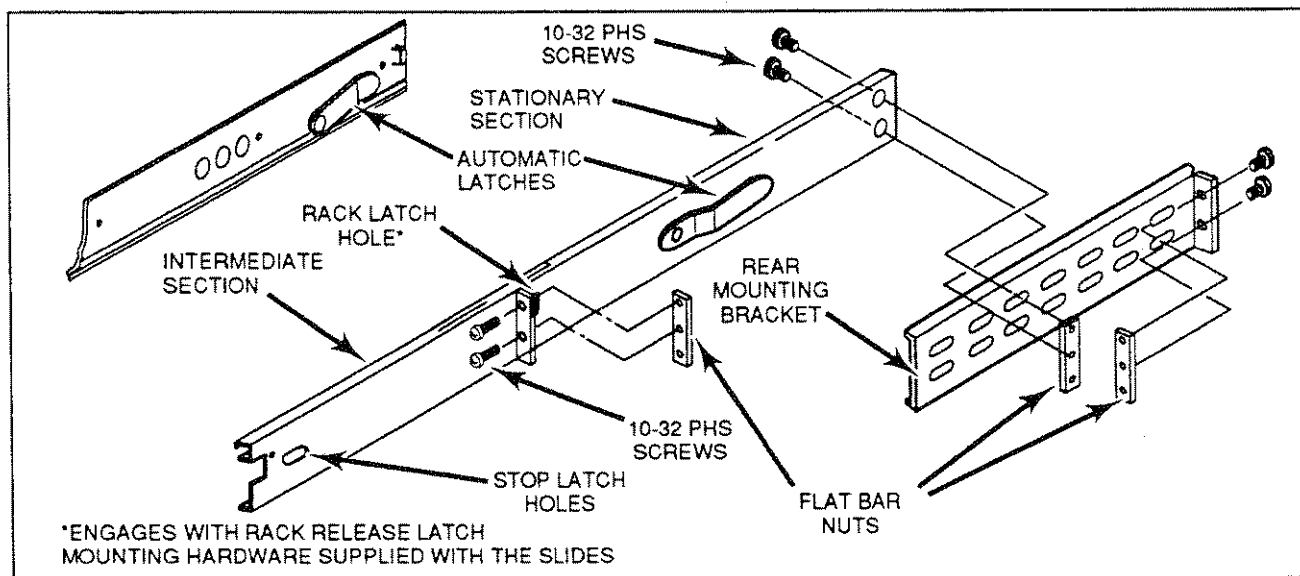

Figure 1-4. Rackmounting Hardware.

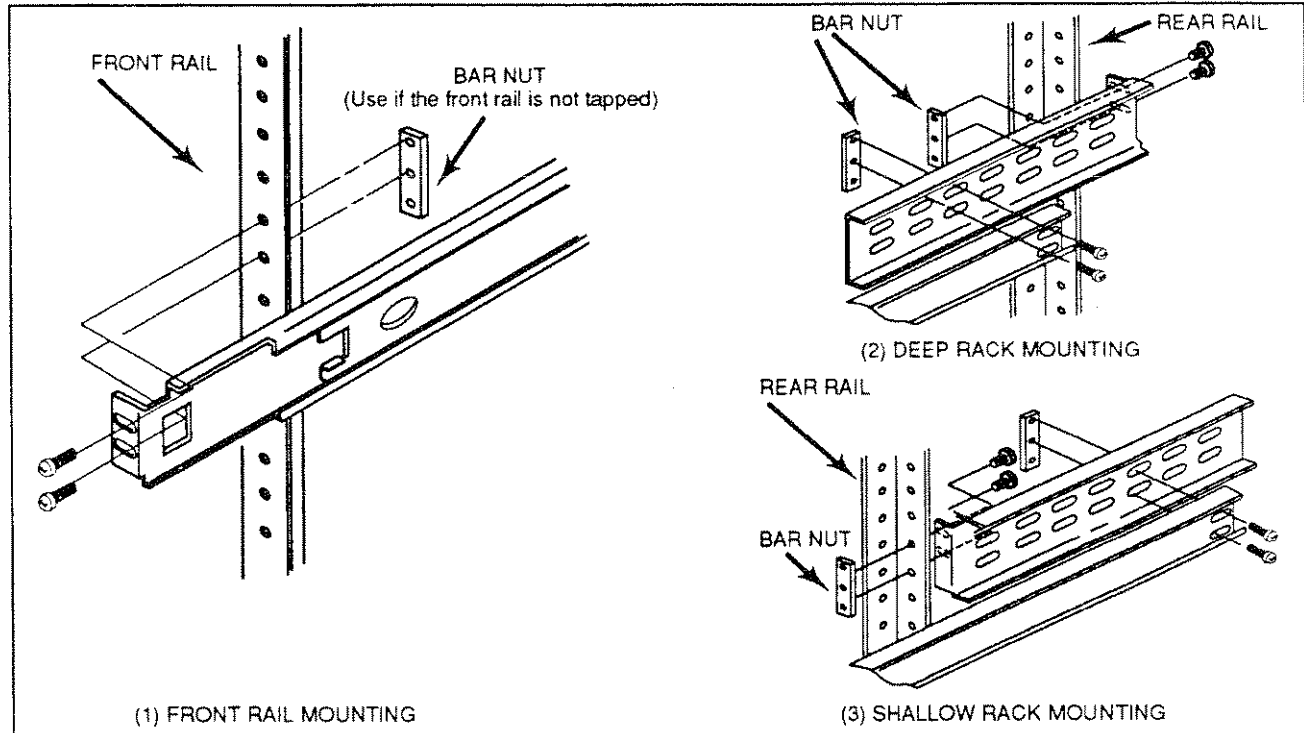

Figure 1-5. Mounting Stationary Rackmount Sections.

5. Push the instrument into the rack, and check that the automatic spring latch engages the spring latch catch to hold the instrument in place.
6. Extend the instrument out of the rack by pulling the rackmount latch releases on the front panel (see Figure 1-1) out to disengage the spring latches. Then, pull the instrument out.
7. Once the instrument is out of the rack, press the latch release and push the instrument back into the rack.

Rackmount to Cabinet Conversion. To convert the 370A rackmount version to a cabinet model, use the following procedure (see Figure 1-6):

1. Remove the bracket from each corner of the instrument rear panel.
2. Replace the left and right side panels with cabinet model side panels.
3. Mount a carrying handle assembly on the left and right sides of the top.
4. Fasten a foot at each corner on the bottom of the instrument.

Cabinet to Rackmount Conversion. To convert the 370A cabinet model to a rackmount version, use the following procedure (see Figure 1-6):

1. Remove the bracket from each corner on the rear panel.
2. Replace the side panels with rackmount version side panels.
 - a) Remove the plastic retainer caps that conceal the screws located at each end of the handle.
 - b) Remove the screw, spacer and bar nut, then lift off the carrying handle assembly.
3. Attach brackets at each corner on the rear panel.
4. Remove both carrying handle assemblies:

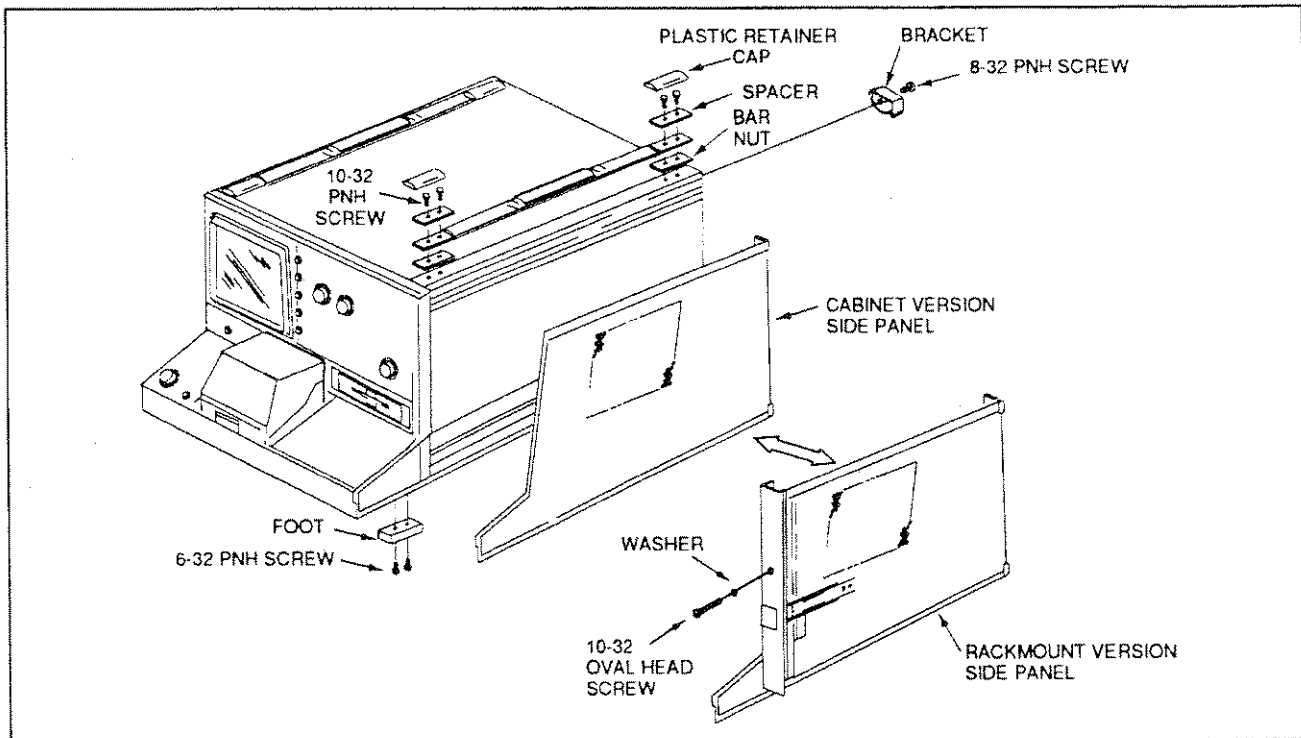

Figure 1-6. Cabinet-to-Rackmount Conversion.

REPACKING FOR SHIPMENT

If this instrument is to be shipped long distances, we recommend that the instrument be repackaged the same as when it arrived. The cartons and packaging material in which your instrument was shipped should be saved and used for this purpose.

If your instrument is to be shipped to a Tektronix Service Center for service or repair, attach a tag to the instrument showing the following:

- Owner of the instrument (with address)
- Name of a person at your firm to contact
- Instrument type
- Instrument serial number
- Description of the service required

If the original packaging is unfit for use or not available, package the instrument as follows:

1. Obtain a corrugated cardboard shipping carton with a 375-pound test strength that has inside dimensions at least six inches greater than the instrument dimensions.
2. Surround the instrument with polyethylene sheeting to protect the finish.
3. Cushion the instrument on all sides by tightly packing dunnage or urethane foam between the carton and the instrument, allowing three inches on all sides.
4. Seal the carton with shipping tape or with an industrial stapler.
5. Write the address of the Tektronix Service Center and your return address on the carton in one or more prominent locations.

SPECIFICATION

Performance Conditions

The following electrical and environmental characteristics are valid for instruments operated at ambient temperatures from +10° C to +40° C after an initial warmup period of 20 minutes, when previously calibrated at a temperature from +15 to +25° C.

**Table 1-4
Electrical Specification**



Characteristic	Performance Requirement	Operating Information
COLLECTOR SUPPLY		
Polarity +LEAKAGE		Applies positive dc voltage to the collector or base terminal. Measures emitter current. Sensitivity is increased 1000 times.
+DC		Applies positive dc voltage to the collector or base terminal. Measures collector or base current.
+ 		Applies positive swept voltage to the collector or base terminal. Measures collector or base current.
AC		Applies line-frequency sine wave to the collector or base terminal. Measures collector or base current.
- 		Applies negative swept voltage to the collector or base terminal. Measures collector or base current.
-DC		Applies negative dc voltage to the collector or base terminal. Measures collector or base current.
-LEAKAGE		Applies negative dc voltage to the collector or base terminal. Measures emitter current. Sensitivity is increased 1000 times.
DC mode ripple (no load)	Less than 2% of output voltage	VARIABLE COLLECTOR SUPPLY at 30% or higher
	Less than 0.5% of output voltage	VARIABLE COLLECTOR SUPPLY at 30% or less
Max peak volts	16 V, 80 V, 400 V, 2000 V	Selected by the MAX PEAK VOLTS buttons.
Voltage accuracy	Peak open circuit voltage on all ranges within +15, -0%	At MAX PEAK POWER of 50 W.

Table 1-4 (cont'd)
Electrical Specification

Characteristic	Performance Requirement	Operating Information
COLLECTOR SUPPLY (cont'd)		
	MAX PEAK VOLTS	
	16 V 80 V 400 V 2000 V	
Max Peak Current	10 A 2 A 0.4 A 0.05 A	
Peak Current, pulsed	20 A 4 A 0.8 A 0.1 A	
Minimum series resistance (Ω)	0.26 6.4 160 20 k	
Maximum series resistance (Ω)	800 20 k 500 k 12.5 M	
Series resistance available (Ω , $\pm 5\%$, or $\pm 0.2 \Omega$)	0.26, 1.3, 6.4, 32, 160, 800, 4 k, 20 k, 100 k, 500 k, 2.5 M, 12.5 M	
Peak power watts 16, 80 and 400 V range 2000 V range	220 W, 50 W, 10 W, 2 W, 0.4 W, 0.08 W 50 W, 10 W, 2 W, 0.4 W, 0.08 W	Derived from nominal peak open-circuit collector voltages and nominal series resistance values.
Variable collector supply 0 - 100.0 %		% of maximum peak voltage value is displayed in the crt readout area. Provides uncalibrated variable collector supply amplitude control from 0 to 100% in 0.1% increments.
Safety interlocks		Applies to all ranges (16, 80, 400, 2000 V). The protective cover must be in place over test terminals and lid shut before voltage can be applied to the terminals.
Warning indicator		Red light indicates dangerous voltage is applied to collector or base terminal.
Limiting indicator		Indicates that internal sensing circuit automatic protection is operating.
Looping compensation Range		At least 100 pF Cancels stray capacitance between DUT terminal and ground.

Table 1-4 (cont'd)
Electrical Specification

Characteristic	Performance Requirement	Operating Information
COLLECTOR SUPPLY (cont'd)		
Sweep start voltage 16, 80 and 400V range		Within $\pm 2\%$ of peak volts
2000V Range		Within $\pm 15\%$ of peak volts
Thermal cutoff		70° C, $\pm 2.8^\circ$ C Collector Supply Amplifier. Series resistors
Current limiter	2.0 A, 1.2 A, 0.2 A	Primary current of collector transformer
Voltage limiter	50%, 25%, 5% of Max Peak Volts	Primary voltage of collector transformer
Arc Killer		Collector supply is disabled at least two cycles while the relays or switches are switching.
Outputs breaker		Enables and disables Collector supply, Step Generator, and AUX outputs. Over current automatically trips the breaker to disable outputs.

NOTE:

The collector supply is limited to a maximum continuous peak current operating time under the following duty cycle and ambient temperature conditions:

With the PEAK POWER WATTS at 50 or 220, the following limitations apply:

50 W

Maximum continuous operating time at rated current (100% duty cycle) into a short circuit is 20 minutes at 25° C ambient, or ten minutes at 40° C ambient.

220W

Maximum continuous operating time at rated current (100% duty cycle) into a short circuit is 3 minutes at 25° C ambient, or 90 seconds at 40° C ambient.

Alternatively, the duty cycle may be limited to 50% at 25° C ambient or 25% at 40° C ambient. (A normal family of transistor curves will produce a duty cycle effect to 50% or less, even if operated continuously.) Collector Supply over-dissipation temporarily shuts off the power, and prints a message on the screen. No damage results when over-dissipation occurs.

Table 1-4 (cont'd)
Electrical Specification

Characteristic	Performance Requirement	Operating Information
STEP GENERATOR		
Accuracy (Current or Voltage Steps including Offset)		
Incremental	1.5%	
Absolute	Less than 1.5% x total output + 3% x STEP AMPLITUDE setting + 1 mV or 1 nA. (less than 1.5% of total output + 10% of STEP AMPLITUDE setting + 1mV or 1nA with STEP MULTI .1X enabled.)	
Offset control range	Variable from -10 to +10 times STEP AMPLITUDE.	
Resolution	STEP AMPLITUDE setting x 1%	
Step transition timing		Within 3% of collector peak volts
Current mode		
Amplitude range	50 nA to 200 mA in a 1-2-5 sequence of 21 steps.	
Maximum current	20 x STEP AMPLITUDE, except 10 x STEP AMPLITUDE when control is set to 200 mA.	Steps and aiding offset
Maximum voltage	At least 10V.	Steps and aiding offset
Maximum opposing offset current	10 x STEP AMPLITUDE	
Maximum opposing volts	Less than 7V.	
Ripple plus noise	Less than 0.5% x STEP AMPLITUDE + 10 nA.	
Maximum inductive load		1 μ H
Output impedance		0.05% of current change per volt
Fall and rise time		Within 25 μ s for 1 step or 100 μ s for 10 steps. 1 k Ω load, 100 μ A/step.
Overshoot and undershoot		Within 10% of transition amplitude.

Table 1-4 (cont'd)
Electrical Specification

Characteristic	Performance Requirement	Operating Information
STEP GENERATOR (cont'd)		
Voltage Mode		
Amplitude switch range	50 mV to 2 V, in a 1-2-5 sequence of 6 steps	
Maximum voltage	20 x STEP AMPLITUDE	
Maximum current	At least 500mA at 10 V or less, at least 200 mA at 15 V, at least 10 mA at 40 V	
Short circuit current limiting	500 mA, +50%, -20%	
Maximum opposing offset volts	10 x STEP AMPLITUDE	
Maximum opposing current	Less than 20 mA	
Ripple plus noise	Less than 0.5% x STEP AMPLITUDE + 10 mV	
Maximum capacitive load		0.01 μ F
Output Impedance		200 m Ω or less
Fall and rise time		Within 50 μ S for 1 step or 100 μ S for 10 steps. 1 k Ω load, 2 V/step.
Overshoot and undershoot		Within 10% of transition amplitude. 1 k Ω load, 2 V/step.
Step rates	2 x line frequency (1 x line frequency in ac collector supply mode). Steps occur at 0 collector voltage.	
Pulsed steps	80 μ s or 300 μ s wide, \pm 10%	At mesial line, with 1 k Ω load, 1 mA /STEP
Steps and offset polarity	Corresponds to Collector Supply Polarity when STEP GENERATOR POLARITY INVERT is disabled. Opposite to Collector Supply Polarity when STEP GENERATOR POLARITY INVERT is selected or CONFIGURATION switch is set to BASE=COMMON. BASE=COMMON configuration disables STEP GENERATOR INVERT.	
Number of steps	Ranges from 0 to 10.	

Table 1-4 (cont'd)
Electrical Specification



Characteristic	Performance Requirement	Operating Information			
AUXILIARY SUPPLY					
Range	From -40 to +40 volts in 20 mV increments.				
Accuracy	Within 50 mV+1.5% of total output				
Output current	At least 100 mA at ± 20 V. At least 10 mA at ± 40 V.				
Ripple plus noise	Less than 50 mV p-p				
NON-STORE VERTICAL DEFLECTION SYSTEM					
Cursor Accuracy		WINDOW Within 0.06 division			
Collector/Base current Range		1 μ A/div to 2A/div in a 1-2-5 sequence of 20 steps. x10 MAG extends maximum sensitivity to 100 nA/div.			
Accuracy		Within 2% of window cursor readout + 0.1 VERT/DIV settings.			
Maximum displayed noise or ripple	Depending on setting of MAX PEAK VOLTS				Except for switching noise at +  and -  mode
	16 V	80 V	400 V	2000 V	
	1 μ A	1 μ A	2 μ A	5 μ A p-p	
Emitter current Range	1 nA/div to 2 mA/div in a 1-2-5 sequence of 20 steps. x10 MAG extends maximum sensitivity to 100 pA/div.				Collector supply polarity is either + LEAKAGE or - LEAKAGE.
Accuracy	Within 2% of window cursor readout + 0.1 x VERT/DIV settings + 1 nA				
Maximum displayed noise or ripple	Depending on setting of MAX PEAK VOLTS				
	16 V	80 V	400 V	2000 V	
	1 nA	1 nA	2 nA	5 nA p-p	

Table 1-4 (cont'd)
Electrical Specification

Characteristic	Performance Requirement	Operating Information
NON-STORE VERTICAL DEFLECTION SYSTEM (cont'd)		
Step generator display Range		1 step/division 1 step/10 divisions with x10 MAG 10 steps/division with STEP MULTI .1x
Accuracy	Within 0.3 division	
Display offset Range		± 10 divisions in 0.1 division steps.
Accuracy		Within 1.5% of offset + 0.1 x VERT/DIV setting
Display magnification Accuracy		x10 Within 1.5% of window cursor readout + 0.3 x VERT/DIV setting.
Display invert accuracy		Within 0.1 x VERT/DIV setting

DIGITAL STORAGE VERTICAL ACQUISITION

A/D Converter Resolution		10 bits for 10.24 divisions, 100 counts per division
Max data points		1024
Max sampling rate		Line frequency x 1024
Min sampling rate		Line frequency x 2
Collector/Base Current Range	1 μ A/div to 2 A/div in a 1-2-5 sequence of 20 steps. x10 MAG extends maximum sensitivity to 100 nA/div (1 nA resolution).	
Accuracy	Within 1.5% of dot cursor readout + 0.05 x VERT/DIV setting.	

**Table 1-4 (cont'd)
Electrical Specification**

Characteristic	Performance Requirement	Operating Information
DIGITAL STORAGE VERTICAL ACQUISITION (cont'd)		
Emitter Current Range	1 nA/div to 2 mA/div in a 1-2-5 sequence of 20 steps. x10 MAG extends max sensitivity to 100 pA/div (1pA resolution).	Collector supply polarity is either + LEAKAGE or - LEAKAGE
Accuracy	Within 1.5% of dot cursor readout + 0.05 x VERT/DIV setting + 1 nA.	
Step Generator display Range		1 step/division 1 step/10 divisions with x10 MAG 10 steps/division with STEP MULTI .1x
Accuracy	Within 0.3 division	
Display offset Range		±10 divisions in 0.1 division steps.
Accuracy		Within 1.5% of offset + 0.01 x VERT/DIV setting
Display magnification Accuracy		x10 Within 1.5% of dot cursor readout + 0.3 x VERT/DIV setting.
Display invert accuracy		Within 0.04 x VERT/DIV setting

NON-STORE HORIZONTAL DEFLECTION SYSTEM

Cursor Accuracy		WINDOW within 0.06 division
Collector Volts Range		50 mV/div to 500 V/div in a 1-2-5 sequence of 13 steps. x10 MAG extends maximum sensitivity to 5 mV/div.
Accuracy		Within 2% of window cursor readout + 0.1 x HORIZ/DIV setting.
Maximum displayed noise	Less than 0.02% of MAX PEAK VOLTS setting.	

Table 1-4 (cont'd)
Electrical Specification

Characteristic	Performance Requirement	Operating Information
NON-STORE HORIZONTAL DEFLECTION SYSTEM (cont'd)		
Base/Emitter Volts Range		50 mV/div to 5 V/div in a 1-2-5 sequence of 7 steps.
		x 10 MAG extends maximum sensitivity to 5 mV/div (50 μ V resolution).
Accuracy		Within 2% of window cursor readout + 0.1 x HORIZ/DIV setting.
Input impedance	At least 100 M Ω	
Maximum displayed noise	Less than 10 mV p-p	With 1 M Ω resistor connected between Base and Emitter terminals, BASE OPEN configuration, and 0 Number of Steps.
Step generator display Range		1 step/division 1 step/10 division with x10 MAG 10 steps/division with STEP MULTI .1x
Accuracy	Within 0.3 division	
Display offset Range		\pm 10 divisions in 0.1 division steps.
Accuracy		Within 1.5% of offset + 0.1 x HORIZ/DIV setting.
Display magnification Accuracy		x10 Within 1.5% of window cursor readout + 0.3 x HORIZ/DIV setting.
Display invert accuracy		Within 0.1 x HORIZ/DIV setting.

Table 1-4 (cont'd)
Electrical Specification

Characteristic	Performance Requirement	Operating Information
DIGITAL STORAGE HORIZONTAL ACQUISITION		
A/D Converter Resolution		10 bits for 10.24 divisions, 100 counts per division.
Max data points		1024
Max sampling rate		Line frequency x 1024
Min sampling rate		Line frequency x 2
Collector Volts Range		50 mV/div to 500 V/div in a 1-2-5 sequence of 13 steps. X10 MAG extends maximum sensitivity to 5 mV/div (50 μ V resolution).
Accuracy	Within 1.5% of dot cursor readout +0.05 x HORIZ/DIV setting.	
Base/Emitter Volts Range	50 mV/div to 2 V/div in a 1-2-5 sequence of 7 steps. x 10 MAG extends maximum sensitivity to 5 mV/div (50 μ V resolution)	
Accuracy	Within 1.5% of dot cursor readout + 0.05 x HORIZ/ DIV setting.	
Step Generator display Range		1 step/division 1 step/10 divisions with X10 MAG 10 steps/division with STEP MULTI .1x
Accuracy		Within 0.3 division
Display offset Range	\pm 10 divisions in 0.1 division steps.	
Accuracy	Within 1.5% of offset + 0.01 x HORIZ/DIV setting.	

Table 1-4 (cont'd)
Electrical Specification

Characteristic	Performance Requirement	Operating Information
DIGITAL STORAGE HORIZONTAL ACQUISITION (cont'd)		
Display magnification Accuracy	X 10 Within 1.5% of dot cursor readout + 0.3 x HORIZ/DIV setting.	
Display invert accuracy	Within 0.04 x HORIZ/DIV setting.	

ACQUISITION MODES

ENVELOPE (normal)		Vertical envelope, Horizontal envelope
AVERAGING		Averages last 16 acquisitions

CRT AND READOUT

CRT Type		Electrostatic deflection
Phosphor		P31
Acceleration potential		12 kV typical
Screen size		7-inch diagonal internal graticule and on-screen scale factor readout.
Total addressable points (graticule area)		1000 x 1000
Geometry	0.5 minor division or less of tilt or bowing; 0.75 minor division or less of keystone.	
Resolution		At least 10 lines/div
Spot size		Within 0.95 mm at screen center; elsewhere on screen: within twice center value.
Orthogonality	90° , within 0.3°.	
Trace rotation range		At least ±3°.

Table 1-4 (cont'd)
Electrical Specification

Characteristic	Performance Requirement	Operating Information
CRT AND READOUT (cont'd)		
READOUT		Automatic on-screen display. Over range shown by a flashing display.
VERT/DIV		100 pA to 2 A.
HORIZ/DIV		5 mV to 500 V.
PER STEP		5 nA to 200 mA, and 5 mV to 2 V.
β OR gm/DIV		500×10^{-9} to 400×10^6 for β and 50×10^{-9} S to 400 S for gm.
CURSOR		4-digit Horizontal and Vertical values without x 10 MAG, 5-digit with MAG.
OFFSET		4-digit value.
% of COLLECTOR PEAK VOLTS		0.0% to 100.0%
Aux Supply		- 40.00 V to + 40.00 V

TEXT DISPLAY

Alphanumeric character Set (1)		ASCII character set except double quote ("), u is recognized as μ GPIB-accessible with the TEXT command.
Alphanumeric character Set (2)		A,B,....,Y,Z,(space),m, u, n,o,,,0, 1,.....,9,- /,*,(,),= Accessible with the Position Control buttons.
Maximum text string length		24 characters
Character size		Approximately 3 mm height, 2 mm width.

Table 1-4 (cont'd)
Electrical Specification





Characteristic	Performance Requirement	Operating Information
ADAPTER CONNECTORS		
Collector		
Collector Sense		
Maximum output voltage		± 2000 V
Maximum output current		± 20 A
Base		
Base Sense		
Maximum output voltage 		± 400 V
Maximum output current		± 20 A
Emitter		
Emitter Sense		
Maximum output voltage 		± 40 V
Maximum output current		± 20 A
Step Gen Out connector		
Maximum output voltage 		± 40 V
Maximum output current		± 2 A
Aux Supply Connector		
Maximum output voltage and current 		± 40 V @ ± 10 mA, or ± 20 V @ ± 100 mA.
Ext Base or Emitter Connector		
Maximum input voltage 		± 40V
Maximum input current		± 2 A

Table 1-4 (cont'd)
Electrical Specification

Characteristic	Performance Requirement	Operating Information	
POWER SOURCE			
Line voltage range		115 VAC 230 VAC	
		High Low	107 - 132 90 - 110
Line frequency range		48.0 to 63.0 Hz	
Power consumption Max. Typical		400W 3.5A 120W 1.3A @ 115V 50 Hz	

**Table 1-5
Physical Specification**

Characteristic	Performance Requirement	Operating Information
Weight Standard instrument Option 1R		37 kg (82 lbs.) 38 kg (84 lbs.)
Height		326 mm (12.8 in) with feet 310 mm (12.2 in) without feet
Width		429 mm (16.9 in)
Depth		635 mm (25.0 in)

**Table 1-6
Environmental Specification**

Characteristic	Performance Requirement	Operating Information
Temperature		
Operating	+10° C to +40° C.	
Storage	-22° C to +60° C.	
Transportation	- 40° C to +65° C.	
Temperature gradient		
Operating	≤15° C per hour (no condensation)	
Storage and transportation	≤ 30° C per hour (no condensation).	
Altitude		
Operating	to 15,000 feet. Maximum operating temperature decreases 1° C each 1,000 feet above 5,000 feet.	
Non-operating	to 50,000 feet	
Humidity		
Operating and non-operating	Five cycles (120 hours) with equipment tested at 80% relative humidity. Tested non-operating at 60 ° C and operating to meet MIL-STD-810C method 507.1 procedure IV, modified as specified in MIL-T-28800B paragraph 4.5.1.1.2.	
Relative humidity		
Operating	20% to 80% (no condensation) Maximum wet bulb temperature shall be 29° C.	
Storage	10% to 90% (no condensation) Maximum wet bulb temperature shall be 40° C.	
Transportation	5% to 95% (no condensation) Maximum wet bulb temperature shall be 45° C.	

Table 1-6 (cont'd)
Environmental Specification

Characteristics	Performance Requirement
EC Declaration of Conformity	Meets intent of Directive 89/336/EEC for Electromagnetic Compatibility. Compliance was demonstrated to the following specifications as listed in the Official Journal of the European Communities:
Emissions	
Enclosure	EN 55011 Class B limits for radiated emissions
AC Mains	EN 55011 Class B limits for conducted emissions EN 60555-2 Power line harmonics
Immunity	
Enclosure	IEC 801-3 RF electromagnetic field, 3 V/m, 27 MHz to 500 MHz IEC 801-2 ESD 8 kV
AC Mains	IEC 801-4, 1 kV _{p-p} , 5/50 ns, T _r /T _h , 5 kHz IEC 801-5, Surge
Electromagnetic Compatibility	
Conducted emissions	DIN 57871/VDE 0871/6.78 Class B MIL-STD 461B/462 for CEO3 (Part 4, #1) FCC Part 15 Subpart J Class A
Conducted susceptibility	MIL-STD-461B/462 for CS01 (Part 7), CS02 (Part 4) and CS06 (Part 5)
Radiated emissions	DIN 57871/VDE 0871/6.78 Class B MIL-STD 461B/462 for REO2 (Part 7) FCC Part 15 Subpart J Class A
Radiated susceptibility	MIL-STD-461B/462 for RS01 (Part 5) and RS03 (Part 7, limited to 1 GHz)
Electrostatic discharge	Mainframe: 15 kV Adapter Socket: 5 kV
Safety	UL3111-1 (Standard for electrical measuring and test equipment) CAN/CSA C22.2 NO.1010.1 (Safety requirements for electrical equipment for measurement, control and laboratory use) IEC1010-1 (Safety requirements for electrical equipment for measurement, control and laboratory use)

Table 1-6 (cont'd)
Environmental Specification

Characteristics	Performance Requirement								
Installation category	<p>Installation Category CAT II (as defined in IEC 1010-1, Annex J)</p> <p>Terminals on this product may have different installation category designations. The installation categories are;</p> <table border="0"> <tr> <td align="left">Category</td> <td align="left">Descriptions</td> </tr> <tr> <td>CAT III</td> <td>Distribution-level mains (usually permanently connected). Equipment at this level is typically in a fixed industrial location</td> </tr> <tr> <td>CAT II</td> <td>Local-level mains (wall sockets). Equipment at this level includes appliances, portable tools, and similar products. Equipment is usually cord-connected</td> </tr> <tr> <td>CAT I</td> <td>Secondary (signal level) or battery operated circuits of electronic equipment</td> </tr> </table>	Category	Descriptions	CAT III	Distribution-level mains (usually permanently connected). Equipment at this level is typically in a fixed industrial location	CAT II	Local-level mains (wall sockets). Equipment at this level includes appliances, portable tools, and similar products. Equipment is usually cord-connected	CAT I	Secondary (signal level) or battery operated circuits of electronic equipment
Category	Descriptions								
CAT III	Distribution-level mains (usually permanently connected). Equipment at this level is typically in a fixed industrial location								
CAT II	Local-level mains (wall sockets). Equipment at this level includes appliances, portable tools, and similar products. Equipment is usually cord-connected								
CAT I	Secondary (signal level) or battery operated circuits of electronic equipment								
Pollution degree	<p>Pollution degree 2 (as defined in IEC 1010-1)</p> <p>Do not operate in environments where conductive pollutants may be present.</p>								
Vibration (operating)	A 15 minute sweep along each of three major axes at a total displacement of 0.003 inch p-p (0.5 G at 55 Hz), with frequency varied from 10 Hz to 55 Hz to 10 Hz. Hold 10 minutes at each major resonance, or if no major resonance present, hold 10 minutes at 55 Hz.								
Shock (non-operating)	20 G, half sine, 11 ms duration, three shocks per axis in each direction for a total of 18 shocks.								
Bench handling	Meets MIL-STD-810C, METHOD 516.2, PROCEDURE V (MIL-T-28800B Section 4.5.5.4.4) with floppy disk drive non-operating and vacant of media.								
Packaged transportation drop	Meets the limits of the National Safe Transit Association test procedure 1A-B-2; 10 drops of 24 inches.								
Packaged transportation vibration	Meets the limits of the National Safe Transit Association test procedure 1A-B-1; excursion of 1 inch p-p at 4.63 Hz (1.1 G) for 60 minutes.								

INTERFACE CHARACTERISTICS

Plotter Interface

The plotter interface is based on IEEE-488-1978 (GPIB) specifications. The 370A can send VIEW or STORE curve data and crt readouts with graphic commands (HPGL) to a plotter.

The IEEE-488-1978 (GPIB) standard defines the GPIB interface functions and the allowed subsets of those functions.

Function	Implemented As
Source handshake	SH1
Acceptor Handshake	AH1
Talker	T4
Listener	L0
Service request	SR0
Remote Local	RL0
Parallel poll	PP0
Device clear	DC0
Device trigger	DT0
Controller	C0

GPIB Interface

The IEEE-488-1978 (GPIB) standard defines the GPIB interface functions and the allowed subsets of those functions.

Function	Implemented As
Source handshake	SH1
Acceptor Handshake	AH1
Talker	T6
Listener	L4
Service request	SR1
Remote Local	RL2
Parallel poll	PP0
Device clear	DC1
Device trigger	DT0
Controller	C0

ACCESSORIES

Standard Accessories

Operator Manual	070-7779-XX
FUSE 250V, 2A, medium-blow	159-0260-00
125V, 4A, medium-blow	159-0259-00
Protective Cover	337-3344-01
Floppy Disk	119-3446-00
Power Cord	161-0066-00
File Management Software FD	063-3341-XX
Test Adapters	
Blank adapter	A1001
In-line adapter	A1002
Axial Lead Adapter	A1005
4 & 6 Lead Transistor Adapter	A1007

Optional Accessories

TO-3/TO-66 Adapter	A1003
Offset Lead/Power Adapter	A1004
Long-Lead Transistor Adapter	A1006
Long-Lead FET Adapter	A1008
4 and 6-Lead FET Adapter	A1009
IC Adapter	A1010
SOT Adapter	A1023

Service Manual	070-7780-XX
Camera Adapter, (C59AP)	016-0244-06
Camera Adapter, C5C op.01	016-0357-01
Camera Adapter, C4 op.02	016-0357-01

Section 2

Controls, Indicators and Connectors

2

Controls, Indicators and Connectors

■ INTRODUCTION

All controls, indicators and connectors required for manual operation of the 370A are located on the front and rear panels of the instrument. In addition, readout of the controls and measurement functions is provided on the crt.

This section includes the descriptions of the functions of the controls, selectors, indicators and connectors, which are shown and identified in Figures 2-1 through 2-10. Readout of the controls and measurement functions is provided on the crt. Some of the functions are described in greater detail in Section 3.

■ FRONT PANEL

The front-panel controls are described on the following pages.

INSTRUMENT POWER AND CRT CONTROLS

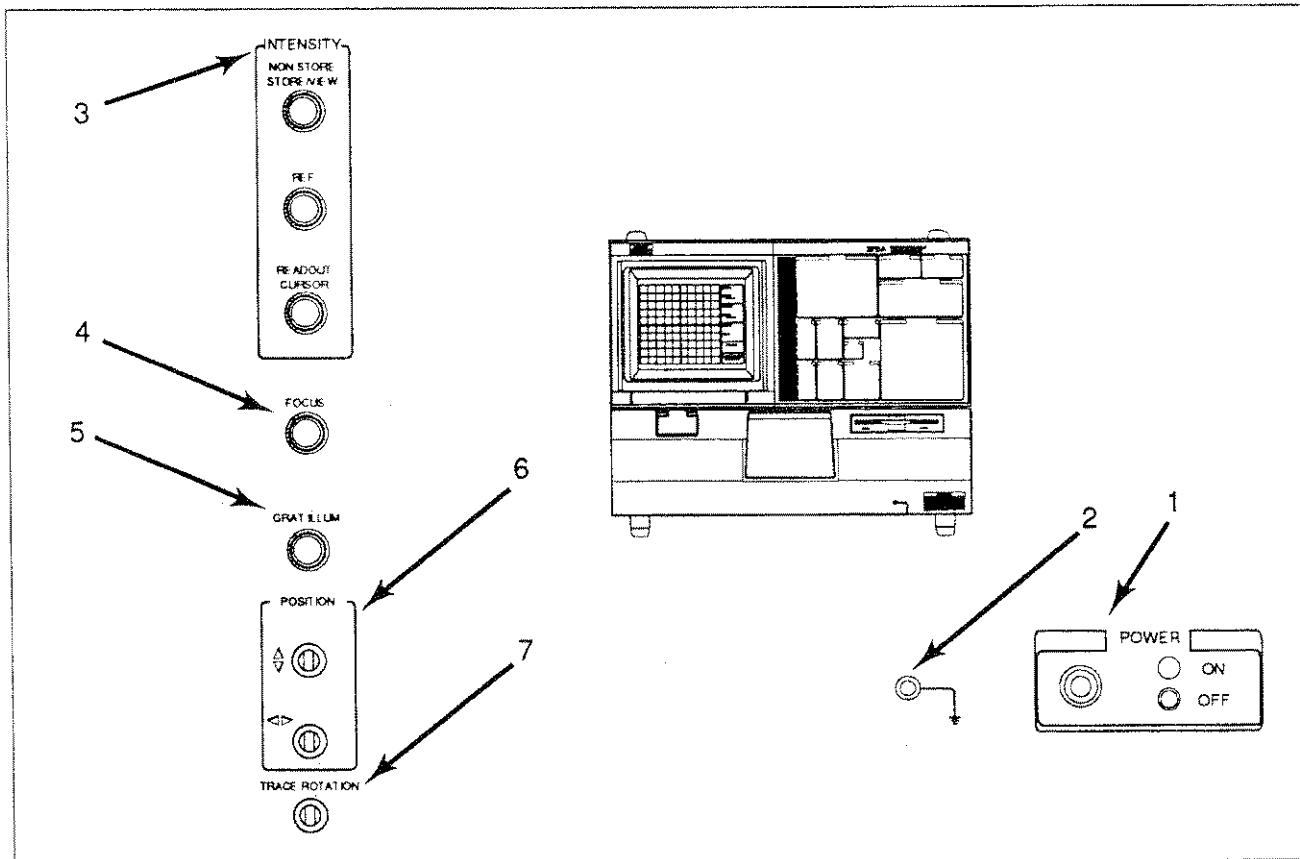

Figure 2-1. Instrument Power and Crt Controls.

1 POWER. Turns instrument power on and off. Press in for ON; press again for OFF. An indicator in the switch shows green when the switch is on and black when it is off.

2 GROUND allows external access to ground reference.

3 INTENSITY. There are three intensity controls: NON STORE/STORE/VIEW, REF, and READOUT/CURSOR.

The DOT cursor intensity is always proportional to NON STORE/STORE/VIEW intensity. The READOUT/CURSOR intensity control has no effect on DOT cursor intensity.

NON STORE/ STORE VIEW controls NON STORE, STORE or VIEW curve display brightness.

REF controls REF curve display brightness.

READOUT/CURSOR controls readout, LINE cursor, and Window cursor display brightness.

4 FOCUS controls display focus.

5 GRAT ILLUM controls internal graticule illumination.

6 POSITION. Operator-adjusted screwdriver controls that vertically and horizontally position the display. These adjustments do not affect the acquired curve data accuracy.

7 TRACE ROTATION. Operator-adjusted screwdriver control for horizontal trace alignment. Once adjusted, readjustment is not required during normal instrument operation.

MEASUREMENT, ACQ MODE (STORE MODE), AND MAG CONTROLS

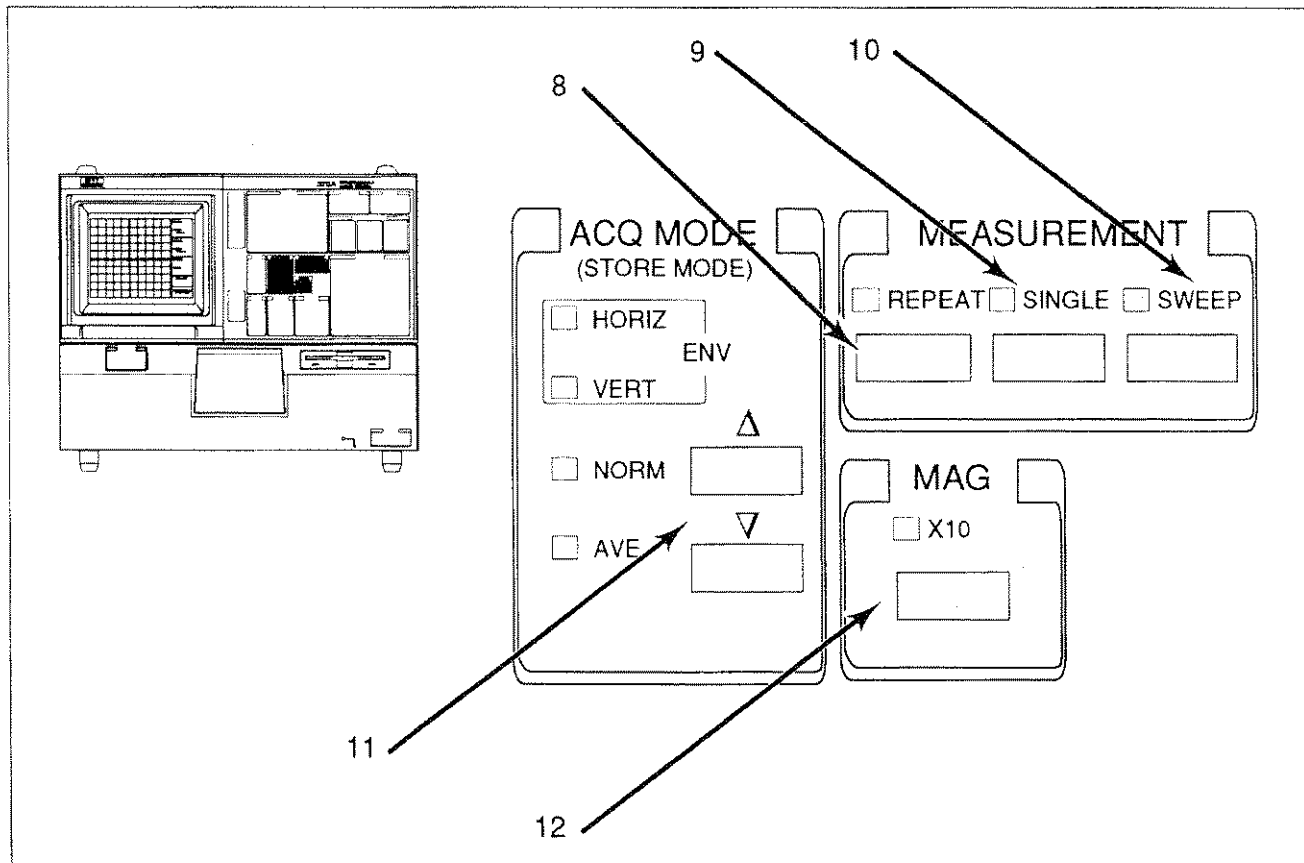

Figure 2-2. Measurement, ACQ Mode, and MAG Controls

The 370A has three measurement modes, REPEAT, SINGLE and SWEEP.

8 REPEAT. Pressing the REPEAT button causes the Step Generator to generate a repeated set of step signals and the measurement is performed repeatedly.

9 SINGLE. Each time the SINGLE button is pressed, the Step Generator generates one step of signals and the measurement is performed once. The Collector Supply and the Auxiliary Supply always provide power regardless of the SINGLE function.

Pressing the SINGLE button while holding down the FAST/SHIFT button changes the button function to USER REQUEST, which causes the 370A to send a service request (SRQ) signal over the bus. This alternate function is not printed below the SINGLE button.

10 SWEEP. Pressing the SWEEP button causes the Collector Supply (or Step Generator) to automatically sweep the output from the value set by the VARIABLE COLLECTOR SUPPLY control (or Step Generator amplitude + offset) to zero (or offset).

The measurement is performed as step signals are generated repeatedly over the sweep range.

For more information on the Sweep function, see the Measurement Modes section in the Operating Instructions (Section 3).

Sweep mode is available when STORE Display mode is selected.

11 ACQ MODE determines data acquisition mode for storage display. This setting does not affect NON STORE, VIEW or REF curves. Modes are:

HORIZ Envelope: When HORIZ Envelope is selected, the horizontal min/max envelopes of the waveforms are displayed. The envelope display continuously accumulates until a setting changes.

VERT Envelope: When VERT Envelope is selected, the vertical min/max envelopes of the waveforms are displayed. The envelope display continuously accumulates until a setting changes.

NORM: Conventional digital storage function.

AVG: Selects 16 times averaging for accurate and precise measurement. This feature provides a filter effect to reduce display noise. The acquisition count is displayed in the upper-right graticule area.

12 MAG X10. Vertically and horizontally magnifies NON STORE and STORE curve displays by a factor of 10. MAG function does not affect VIEW and REF curves.

MEMORY INDEX AND SETUP CONTROLS

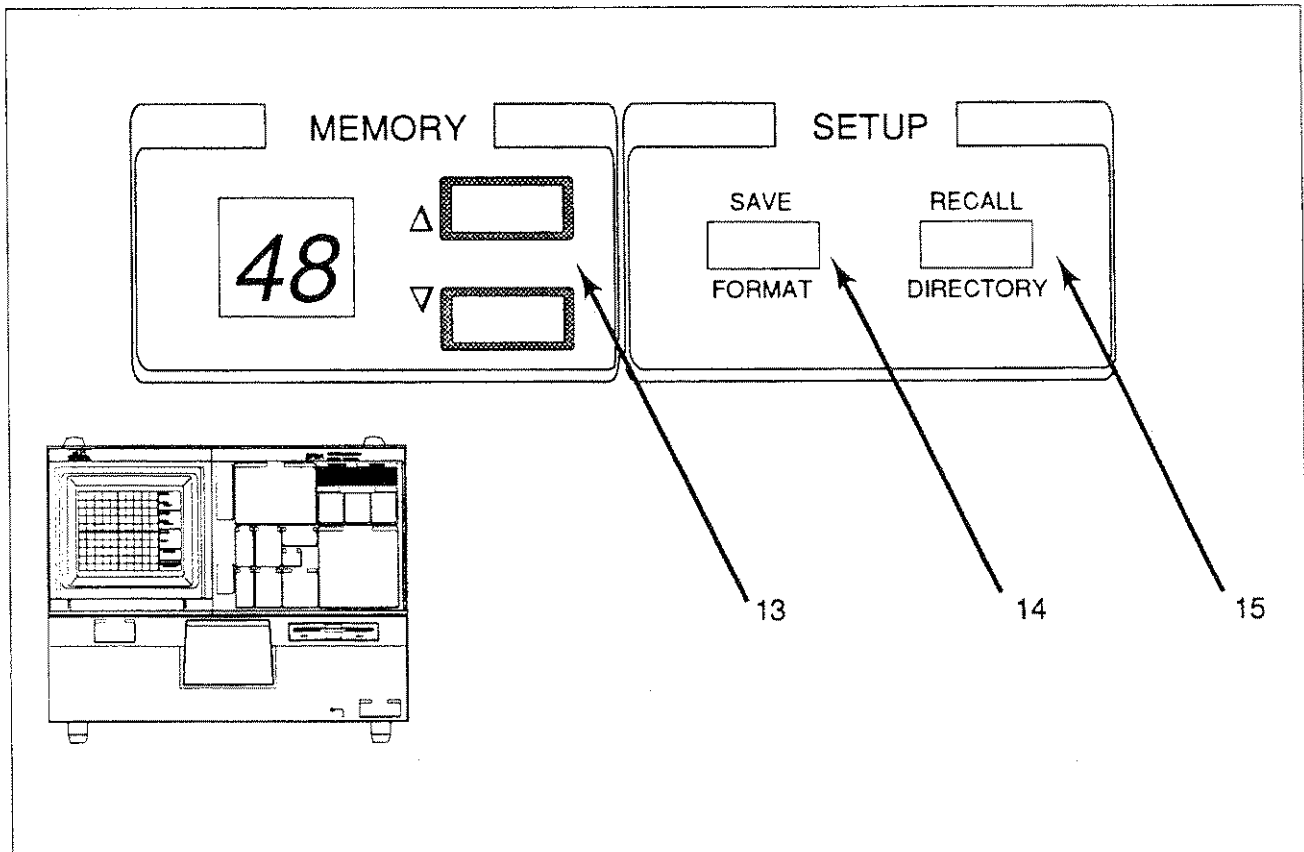

Figure 2-3. Memory Index and Setup Controls.

The mass storage system of the 370A consists of non-volatile IC memory and 3.5-inch floppy disk drive that store characteristic curves and front-panel setups. The Memory Index display indicates the memory location that identifies where curves or setups are stored in the mass storage. Up to 16 characteristic curves and 16 front-panel setups can be stored in internal non-volatile IC memory. Up to 64 characteristic curves and 64 front-panel setups can be stored in a floppy disk.

13 Memory index display indicates the memory location for ENTER, SAVE, RECALL and VIEW functions. The index number can be increased or decreased by up and down buttons to the right of the display. The Index numbers from 1 to 16 are for non-volatile IC memory. The Index numbers from 17 to 80 are for 3.5-inch floppy disk.

Holding down the FAST/SHIFT button while pressing either of the MEMORY buttons increases the rate of change.

Simultaneously pressing the two MEMORY buttons sets the index number to 1.

The setup save/recall function allows you to save or recall a group of front panel settings. All of the front panel settings, except those stated in Table 2-1, can be stored in or recalled from the mass storage.

14 SAVE/FORMAT. Front-panel setups are saved in the mass storage when SAVE is pressed. The memory index display indicates the index number of the memory location where the setups are stored. If a REF curve is displayed, it is also saved as a part of the set-up.

Pressing the SAVE button while holding down the FAST/SHIFT button, then pressing the SAVE button, changes the button function to FORMAT, which formats a floppy disk. If the SAVE button is not pressed within a few seconds after pressing the SAVE/FORMAT and FAST/SHIFT buttons, the formatting operation is canceled. A new disk must be formatted before it is accessed for the first time.

CAUTION

Formatting a disk destroys all information currently on the disk. Make sure you no longer need this data before you format the disk.

15 RECALL/DIRECTORY recalls a previously-stored group of 370A front-panel settings. When RECALL is pressed, the 370A is set to the front-panel settings stored in the mass storage. SETUP ID number is displayed at the bottom center of the crt for about five seconds and is then automatically erased.

Pressing the RECALL button while holding down the FAST/SHIFT button changes the button function to DIRECTORY, which displays a directory of the contents of the mass storage.

Table 2-1
Front Panel Controls Settings Not Stored

COLLECTOR SUPPLY	LOOPING COMPENSATION
DISPLAY	ENTER
SETUP	RECALL SAVE
MEMORY Index	
CRT CONTROL	INTENSITY FOCUS GRATICULE ILLUM POSITION TRACE ROTATION
GPIB	LOCAL PLOT/CURVE

DISPLAY CONTROLS

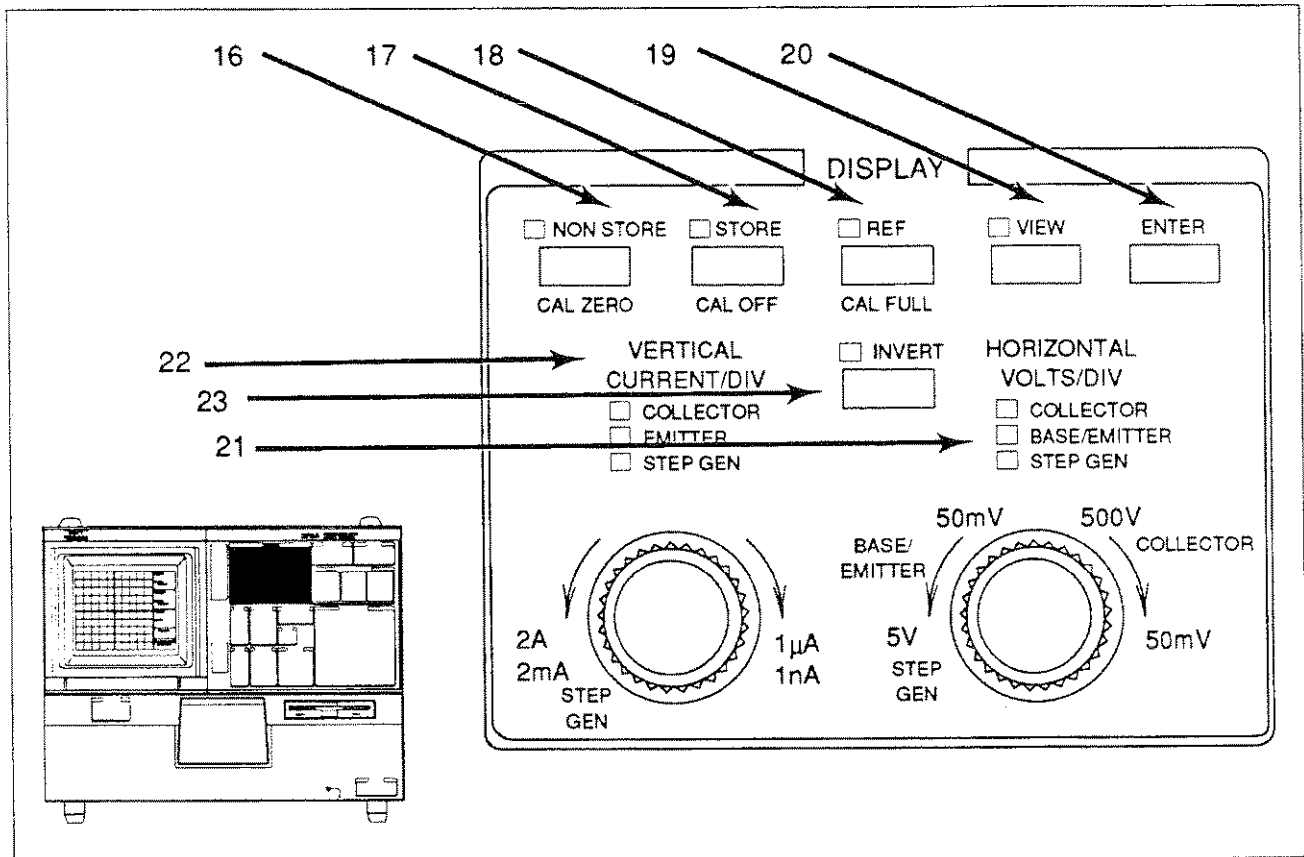

Figure 2-4. Display Controls.

16 NON STORE/CAL ZERO provides a real-time analog display of device characteristics.

Pressing the NON STORE button while holding down the FAST/SHIFT button changes the button function to CAL ZERO, which displays a dot in the bottom left corner of the screen.

The CAL ZERO dot provides a reference to check the CRT deflection at the zero point on the vertical and horizontal graticule lines.

While in the calibration mode, "CAL" is displayed in the upper right corner of the display graticule.

17 STORE/CAL OFF. Digitally acquired curves are displayed on the crt.

Pressing the STORE button while pressing the FAST/SHIFT button changes the button function to CAL OFF, which cancels the CAL FULL and CAL ZERO functions.

18 REF/CAL FULL. Pressing the REF button saves the currently displayed STORE or VIEW curve in the reference waveform memory and displays the entered curve as a REF (reference) curve. The STORE or VIEW curve can be displayed together with the REF curve.

If the SAVE button is pressed while the REF curve is displayed, it is saved along with front-panel settings as part of the setup. The REF curve remains on the crt until the REF button is pressed again or NON STORE display mode is selected.

Pressing the REF button while holding down the FAST/SHIFT button changes button function to CAL FULL, which displays a dot in the upper right corner of the screen.

370A Operator's Manual

The CAL FULL dot provides a reference for checking the CRT deflection at the 10th graticule lines (vertical and horizontal).

While in the calibration mode, "CAL" is displayed in the upper right corner of the display graticule.

19 VIEW displays the previously entered curves from the mass storage. Memory Index display indicates the display curve identification number. CURVE ID number is displayed at the bottom right of the crt for about 5 seconds and is then automatically erased. If any setting (except REF) is changed while in VIEW mode, the display mode is changed to STORE mode automatically to reflect the setting change result.

If the VIEW button is pressed while holding down the FAST/SHIFT button, the function of this button changes to COPY. This copy function can be used to copy simultaneously up to 16 characteristic curves and up to 16 front-panel setups from floppy disk to non-volatile IC memory.

Before using this function, the MEMORY buttons must be set to the starting position in memory for the source of the data to be copied.

If the VIEW button is pressed while holding down the FAST/SHIFT button, the "PRESS VIEW" message is displayed for approximately five seconds. If the VIEW button is pressed during this period, copying begins. If the VIEW button is not pressed, the function is cancelled, and the "COPY CANCELLED" message is displayed. Copying starts with the characteristic curve data, followed by front-panel setup data. Copying of curve data starts by writing this data at the specified starting position in memory position number 1, followed by the next curve data being copied into memory position number 2, and so on.

At the point at which 16 curves are written from floppy disk into non-volatile IC memory, the copying of the curve data is terminated. However, should the number of stored curves be less than 16 when the memory position for identifier number 80 is reached, the copying of the curves is completed when all the curves are copied. In this case, all the contents stored into IC memory will not be overwritten, and the memory contents at the memory positions numbered as the number of curves copied plus 1 through 16 remain unchanged.

During execution of the copying operation, the MEMORY index display indicates that identifier number of the source currently being copied. When the copying of the curve is complete, the copying of the front-panel setups begins, following the same type of sequence as for the curves.

NOTE

When copying, the 370A does not accept any type of interrupt.

20 ENTER stores the currently displayed STORE or VIEW curves in the mass storage. The Memory Index display indicates the memory location where the current display will be stored. The Enter function is not used with the NON STORE display mode.

If the ENTER button is pressed while holding down the FAST/SHIFT button, the function of this button changes to COPY. This copy function can be used to copy simultaneously up to 16 characteristic curves and up to 16 front-panel setups from non-volatile memory to floppy disk.

Before using this function, the MEMORY buttons must be set to the starting position in memory for the destination of the data to be copied.

If the ENTER button is pressed while holding down the FAST/SHIFT button, the "PRESS ENTER" message is displayed for about five seconds. If the ENTER button is pressed during this time, copying begins. If the ENTER button is not pressed, the function is cancelled, and the message "COPY CANCELLED" is displayed. Copying starts with the characteristic curve data, followed by front-panel setup data. Copying of curve data starts by writing this data at the specified starting position in memory position number 1, followed by the next curve data being copied into memory position number 2, and so on.

At the point at which 16 curves are written from non-volatile IC memory to floppy disk, the copying of the curve data is terminated. However, should the number of stored curves be less than 16 when the memory position for identifier number 80 is reached, the copying of the curves is completed when all the curves are copied. In this case, not all the contents stored into IC memory will be copied onto floppy disk.

During execution of the copying operation, the MEMORY index display indicates that identifier number of the destination. When the copying of the curve is complete, the copying of the front-panel setups begins, following the same type of sequence as for the curves.

NOTE

When copying, the 370A does not accept any type of interrupt.

21 HORIZONTAL selects horizontal deflection factors (VOLTS/DIV) and horizontal sources (COLLECTOR, BASE/EMITTER or STEP GEN).

Full clockwise rotation:

1. Selects COLLECTOR voltage source,
2. Turns on the COLLECTOR indicator LED,
3. Displays crt readout for the horizontal deflection factor.

In COLLECTOR position, horizontal deflection factor for COLLECTOR voltage can be selected from 50 mV to 500 V in 1-2-5 sequence. When the CONFIGURATION mode is the BASE COLLECTOR SUPPLY mode, base to emitter (VBE) is displayed on the horizontal axis.

Counterclockwise (ccw) rotation from 500 V/DIV of COLLECTOR position enters BASE/EMITTER position and the BASE/EMITTER indicator LED turns on. In BASE/EMITTER position, the control selects horizontal deflection factor of either BASE or EMITTER voltage from 50 mV to 5 V in a 1-2-5 sequence. Either BASE or EMITTER voltage is determined by the CONFIGURATION mode, as follows:

CONFIGURATION	HORIZONTAL VOLTAGE
BASE: STEP GEN	BASE
BASE: OPEN (EXT)	BASE
BASE: SHORT (EMITTER)	BASE
EMITTER: OPEN (EXT)	EMITTER
EMITTER: STEP GEN	EMITTER

Full counterclockwise rotation selects STEP GEN, which turns on STEP GEN indicator LED, and the HORIZ/DIV and horizontal CURSOR readouts disappear.

22 VERTICAL selects vertical deflection factors and vertical sources (COLLECTOR/BASE or STEP GEN).

Full ccw rotation of the VERTICAL control displays STEP GEN signal source and turns on STEP GEN LED. When STEP GEN is selected, the VERT/DIV and vertical CURSOR readouts disappear.

When COLLECTOR source signal is selected, deflection factor (CURRENT/DIV) can be selected from 1 μ A to 2 A in a 1-2-5 sequence. When the CONFIGURATION mode is the BASE COLLECTOR supply, base current is displayed on the vertical axis. When either +LEAKAGE or -LEAKAGE mode is selected for COLLECTOR SUPPLY POLARITY (EMITTER LED turns on), emitter current can be measured and the vertical deflection factor is divided by 1000.

23 INVERT horizontally and vertically inverts NON STORE or STORE curve at graticule center; also lights INVERT LED. INVERT function does not affect VIEW and REF curve.

Pressing the INVERT button while holding down the FAST/SHIFT button, then pressing the INVERT button, changes the button function to ERASE, which erases the entire non-volatile IC memory. If the INVERT button is not pressed within a few seconds after pressing the INVERT and FAST/SHIFT buttons, the erase operation is canceled. This alternate function is not printed below the INVERT button.

CURSOR CONTROLS AND POSITION CONTROLS

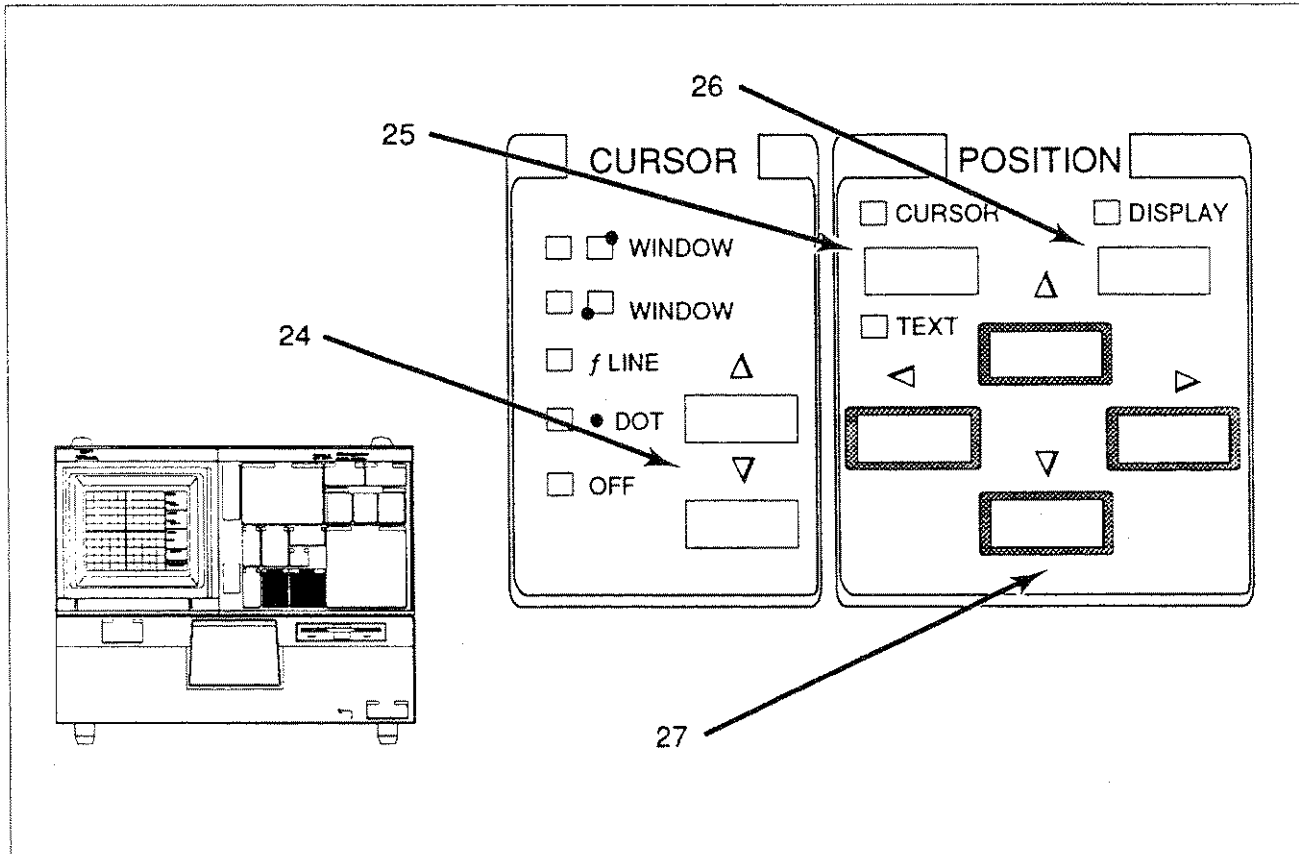

Figure 2-5. Cursor Controls and Position Controls

24 Cursor Selection selects one of the three types of cursor: DOT, f LINE, or WINDOW.

DOT: The DOT cursor is a high-intensity dot displayed on the trace. The voltage and current at the DOT cursor position are indicated in the CURSOR readout area. The DOT cursor can be positioned with the four Position Control buttons. It can also be used to measure DC β .

If the Dot cursor is positioned off-screen, both the vertical and horizontal CURSOR readouts blink.

When REF curve is displayed, the DOT cursor is displayed only on the STORE or VIEW curve. In NON STORE display mode, the DOT cursor is not displayed.

f LINE: The f LINE (functional line) cursor is a straight line which passes through the DOT cursor position at a slope that can be changed by the four Position Control buttons. The slope is indicated in the CURSOR (f:1/gradient) area of the readout.

The point at which the f LINE cursor intercepts the horizontal axis is indicated in the CURSOR (f:intercept) area of the readout, giving the horizontal coordinate value.

The f LINE cursor can be used to measure the "on" resistance or horizontal intercept voltage of the device.

When REF curve is displayed, the f LINE cursor appears only on the STORE or VIEW curve. The f LINE cursor is not available in NON STORE mode.

WINDOW: The WINDOW cursor is displayed as a rectangle and can be used in any display mode as a reference for visual checks. It can also be used to measure small signal β (Hfe).

The WINDOW cursor has two modes, depending on whether the base point is at the top right or bottom left corner. Cursor movement and the cursor readout display are referenced to this base point.

25 CURSOR directs the Position Control buttons to the cursor. Even when the up or down Cursor Selection button is pressed to select a cursor, this mode is automatically selected.

Pressing the ENTER button while holding down the FAST/SHIFT button changes the button function to TEXT, which places the 370A in the Text Edit Mode. The Text Edit mode provides text entry to the Text Area of the display and revision of existing text.

To enter text, select the character position in the Text Area with the left and right Position Control buttons (left and right) and select each character from the pre-defined set of characters with the up and down Position Control buttons. The Text Area will display up to 24 characters.

The available characters are listed below in the order in which they are presented by the up and down Position Control buttons: space,A,B,...Z, space,m,u,n,p,..,0,1,...9,-,/,*,(,),=, space.

To edit text, use the left and right Position Control buttons to position the cursor on the character to be changed. Use the up and down Position Control buttons to overwrite the character or the FAST/SHIFT button to delete the character at which the cursor is displayed. To delete all of the text, press the left and right Position Control buttons simultaneously.

To exit the text edit mode, press the CURSOR/TEXT button.

26 DISPLAY directs the Position Control buttons to the display offset. When the cursor is selected, this mode is automatically exited.

27 Position Control. When the Position CURSOR button is selected (CURSOR LED indicator turns on), the four Position Control buttons (up,down, right, and left) are used to move the cursor or change the slope of the f LINE cursor.

When the Position DISPLAY button is pressed (DISPLAY LED indicator turns on), the four Position Control buttons control vertical and horizontal display offset with 0.1 division per step. Pressing any of the Position Control buttons while holding down the FAST/SHIFT button changes display offset with one division per step. Simultaneously pressing the up and down Position Control buttons cancels vertical display offset. Simultaneously pressing the left and right Position Control buttons cancels horizontal display offset.

The Position Control buttons are also used to edit the crt text.

STEP GENERATOR CONTROLS

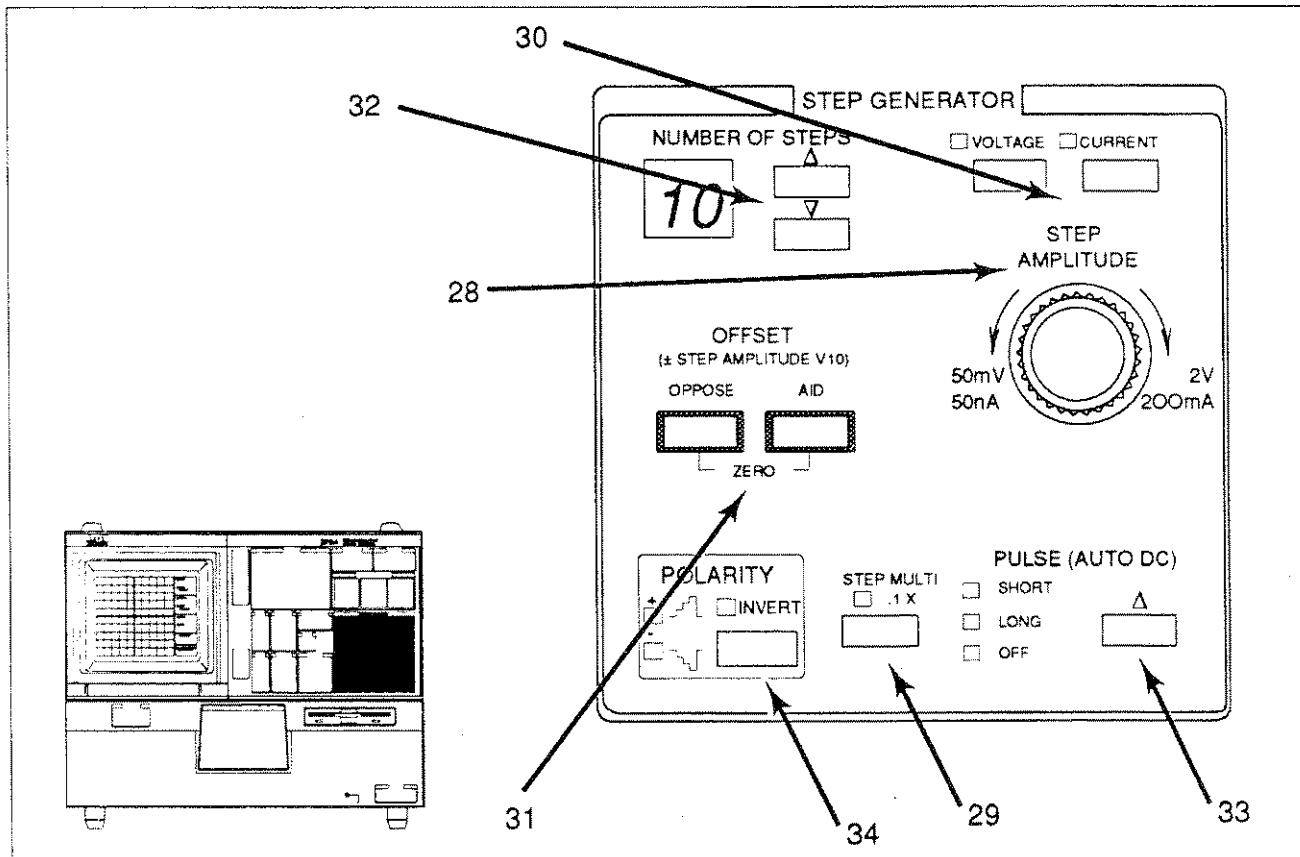

Figure 2-6. Step Generator Controls.

28 **STEP AMPLITUDE** sets the amplitude of the generated steps. The step amplitude ranges from 50 nA to 200 mA per step in current output mode and from 50 mV to 2 V per step in voltage output mode in a 1-2-5 sequence.

29 **STEP MULTI .1X** reduces the step signal amplitude by a factor of ten without affecting the offset amplitude. The indicator above the STEP MULTI .1X button lights when the Step Multi function is enabled.

30 **Output Mode Selections** selects the Step Generator output mode. The selected output mode is indicated by the LED. When pressing the **VOLTAGE** or **CURRENT** button while holding down the **FAST/SHIFT** button, the Step Generator **OFFSET** can be set independently of the **STEP AMPLITUDE** setting. Pressing the **VOLTAGE** or **CURRENT** button while holding down the **FAST/SHIFT** button once again cancels this function.

VOLTAGE sets the Step Generator output to a voltage step signal.

CURRENT sets the Step Generator output to a current step signal.

31 **OFFSET AID** and **OPPOSE** buttons control offset value. The offset value ranges from +10 to -10 times the **STEP AMPLITUDE** at 1% resolution. The offset value is displayed on the crt.

AID: The step offset with the same polarity as the polarity setting adds to the step generator output.

OPPOSE: The step offset with the opposite polarity as the polarity setting subtracts from the step generator output.

Holding down the FAST/SHIFT button while pressing either of the OFFSET buttons causes offset changes to be in larger increments.

Simultaneously pressing the AID and OPPOSE buttons sets the offset to zero.

32 NUMBER OF STEPS selects the number of steps produced by the Step Generator. The number of steps may be selected from 0 to 10, and when 0 is selected, the Step Generator output consists of offset only. The NUMBER OF STEPS display indicates selected number. When the COLLECTOR SUPPLY POLARITY mode is +LEAKAGE or -LEAKAGE, the number of steps is automatically set to 0.

33 PULSE. LONG or **SHORT** pulse mode is enabled and the step generator supplies either pulsed current or voltage to the base or emitter terminal, as selected. With the aiding offset, the offset is added to the step signal as a pulse. Pulse width: 80 μ S for SHORT and 300 μ S for LONG. Selecting OFF disables Pulse mode. Selecting PULSE mode automatically selects the DC mode of COLLECTOR SUPPLY polarity function. When the Collector Supply POLARITY mode is +LEAKAGE or -LEAKAGE, the pulse mode is not available.

34 POLARITY and INVERT.

POLARITY indicator indicates the step generator output polarity determined by the Collector Supply POLARITY settings, CONFIGURATION, and the INVERT setting.

Pressing **INVERT** reverses the step generator output polarity. The LED next to the INVERT button indicates if the inverted state is selected. When the configuration control is set to BASE COMMON, pressing INVERT does not effect the actual Step Generator polarity, and the polarity indicator does not change; only the INVERT indicator changes.



Table 2-2 shows the Step Generator Polarity in relation to the Collector Supply Polarity, Configuration mode and INVERT button. For example, if the mode is EMITTER COMMON and the POLARITY is + , +DC, or +LEAKAGE, the INVERT button controls the Step Generator Polarity.

Table 2-2 Step Generator Polarity

COLLECTOR SUPPLY setting	CONFIGURATION mode setting	
	BASE COMMON	EMITTER COMMON
+  + DC + LEAKAGE	-	+ (INVERT OFF) -(INVERT ON)
-  -DC -LEAKAGE	+	-(INVERT OFF) + (INVERT ON)
AC	-	+ (INVERT OFF) -(INVERT ON)

COLLECTOR SUPPLY CONTROLS

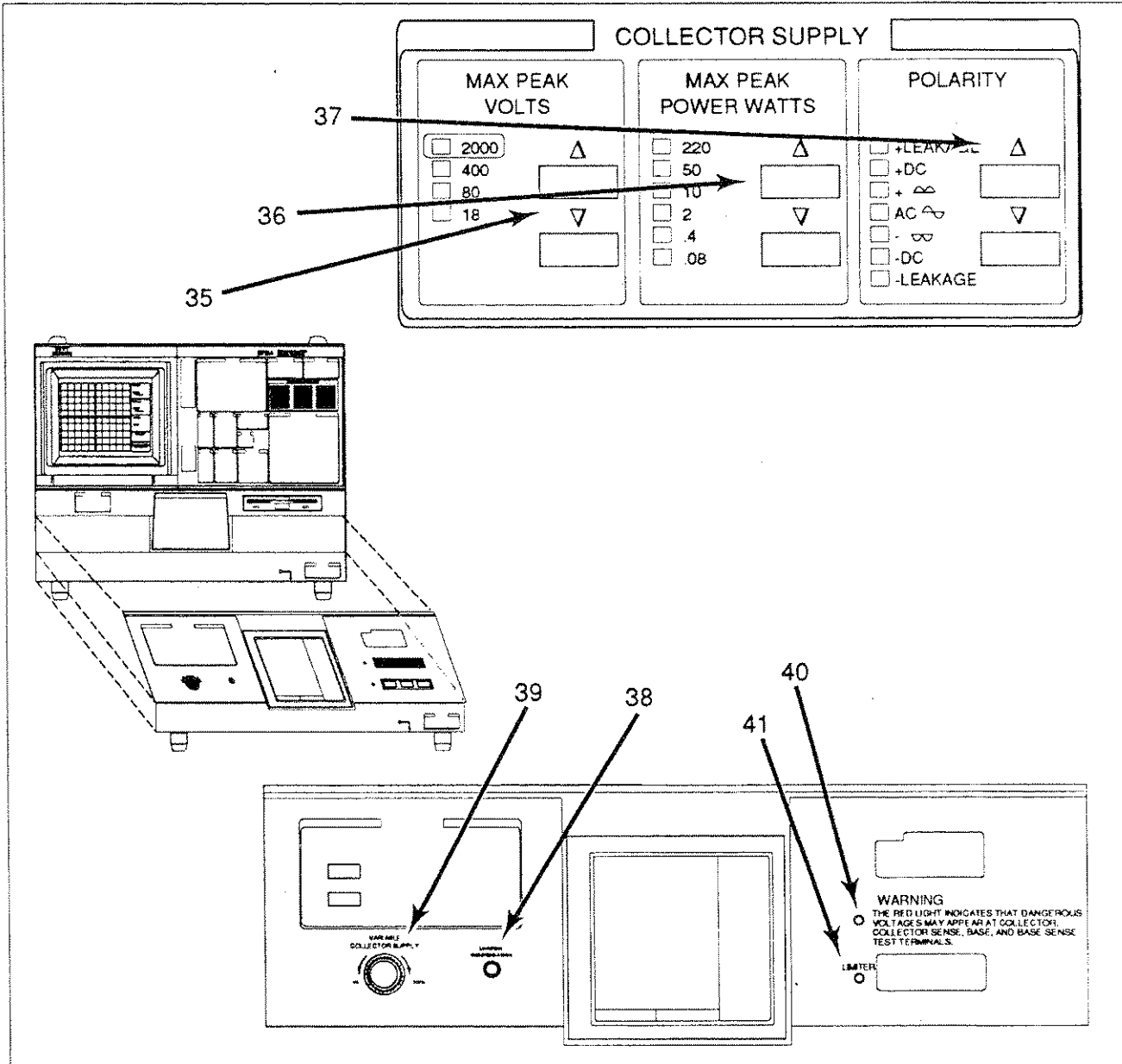

Figure 2-7. Collector Supply Controls.

WARNING

When using the 370A at high power settings, the device, fixture, or protective cover may become hot enough to cause injury. Avoid touching any of these items until cooled.

WARNING

Dangerous voltage may appear at the front-panel collector and base terminals. To avoid injury or equipment damage, do not remove the protective cover.

48 **Adapter Connector** allows connection of various test adapters.

49 **LEFT, RIGHT and STANDBY** select the device to be tested (left or right).

50 **STEP GEN OUT.** Step Generator signal is available at this terminal.

51 **AUX OUT.** Auxiliary Supply Output Terminal.

52 **EXTBASE or EMITTER IN** allow input of an externally generated signal to either the base terminals or emitter terminals of the device as determined by the **CONFIGURATION** controls.

53 **CONFIGURATION.** The **CONFIGURATION** buttons select **BASE EMITTER**, and **COLLECTOR** terminal connections. The LED indicates the selected configuration. **COMMON** is connected to ground, but through the current-sense resistor in the **LEAKAGE** mode. When **BASE COMMON** is selected, the **STEP GENERATOR INVERT** button is disabled. When the **CONFIGURATION** setting is changed to or from **COLLECTOR OPEN**, the Collector Supply output automatically goes to 0%. When either **BASE SHORT (EMITTER)** or **BASE COLLECTOR SUPPLY** is selected, the output and readout display of the Step Generator is disabled. Also the **STEP AMPLITUDE, OFFSET, VOLTAGE,** and **CURRENT** controls are disabled.

REAR PANEL

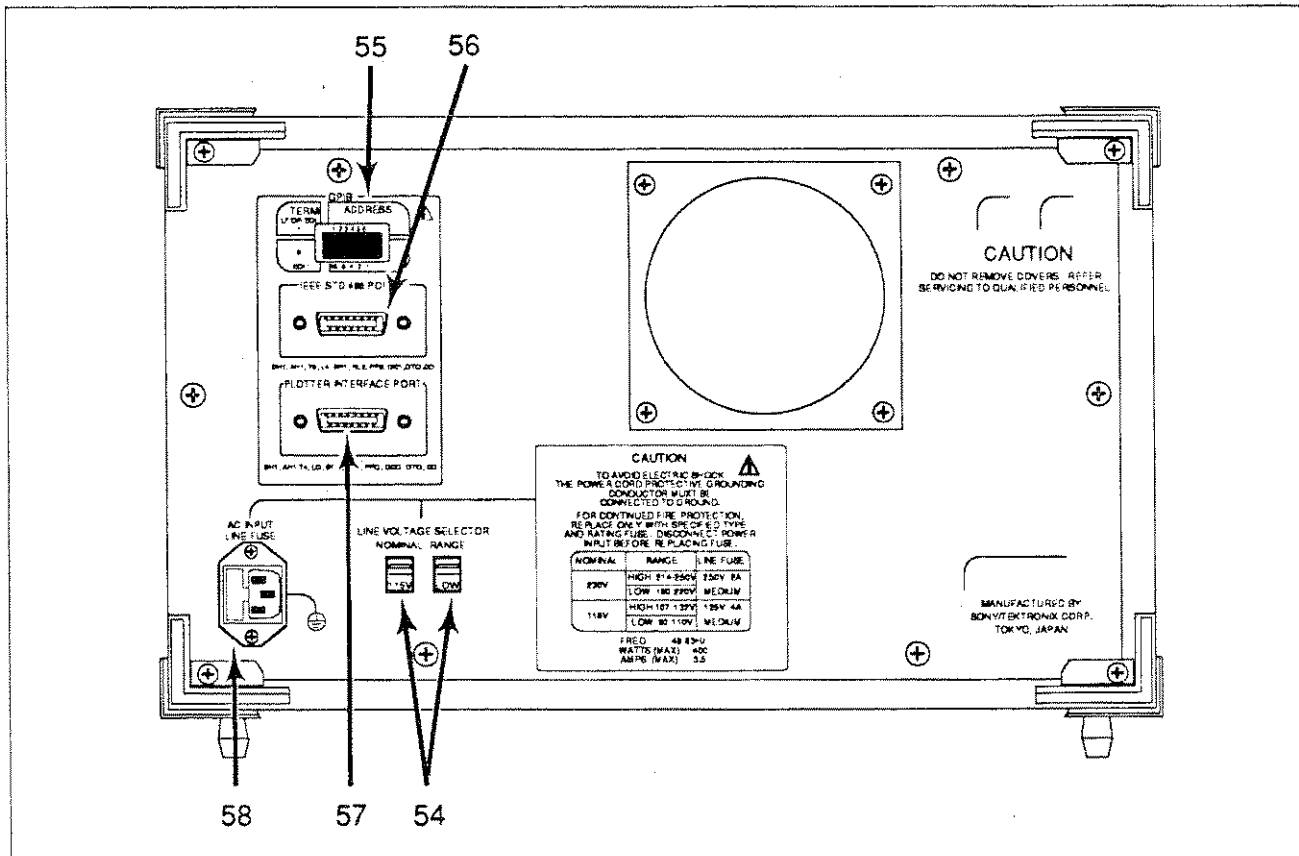

Figure 2-10. Rear-panel controls and connectors.

54 **LINE VOLTAGE SELECTOR** selects either 115 V or 230 V nominal ac power source, either High or Low voltage operation for each line voltage selection.

55 **GPIB TERMINATOR** and **ADDRESS** switch select GPIB address and message terminator.

56 **IEEE STD 488 PORT** interfaces IEEE-488 Standard Bus Interface Connector.

57 **PLOTTER INTERFACE PORT** interfaces to a Plotter.

58 **AC INPUT** Connector and **LINE FUSE** Holder. Provides the connection point for the ac power source to the instrument. Contains the ac power-source fuse.

Table 2-5
The FAST/SHIFT Button Used With Other Buttons

Button	Effect of Pressing the FAST/SHIFT button
SINGLE	Changes the button function to USER REQUEST, which causes the 370A to send a service request (SRQ) signal over the bus. This alternate function is not printed below the button.
MEMORY	Increases or decreases the rate of change of the Memory Index number
SAVE	Changes the button function to FORMAT, which formats a floppy disk.
RECALL	Changes the button function to DIRECTORY, which displays a directory of the contents of the mass storage.
NON STORE	Changes the button function to CAL ZERO, which displays a dot to check the deflection accuracy of the crt.
STORE	Changes the button function to CAL OFF, which turns off the Cal Full or Cal Zero display.
REF	Changes the button function to CAL FULL, which displays a dot to check the deflection accuracy of the crt.
Display INVERT	Changes the button function to ERASE, which erases the entire non-volatile IC memory. This alternate function is not printed below the button.
Mag X10	Changes the button function to ID, which displays and removes the 370A's firmware version number on the screen. This alternate function is not printed below the button.
CURSOR	Changes the button function to TEXT, which places the 370A in Text Edit mode for text entry and revision.
Position Control OFFSET	Increases the rate of cursor movement or display offset.
(OPPOSE and AID)	Increases the rate of offset increase or decrease.
AUX	Increases the rate of auxiliary supply output voltage.
LOCAL	Changes the button function to ADDR, which reads in the settings of the rear-panel Configuration Switch Band and displays them on the crt.
PLOT	Changes the button function to CURVE, which plot only the curve (without the graticule, cursor, text, and readout).
VIEW	Changes the button function to COPY, which copies the contents of the floppy disk to non-volatile IC memory. This alternate function is not printed below the button.
ENTER	Changes the button function to COPY, which copies the contents of non-volatile IC memory to floppy disk. This alternate function is not printed below the button.

SIGNAL OUTPUT CONTROLS AND CONNECTORS, CONFIGURATION CONTROLS AND INDICATORS, AND INPUT CONNECTOR

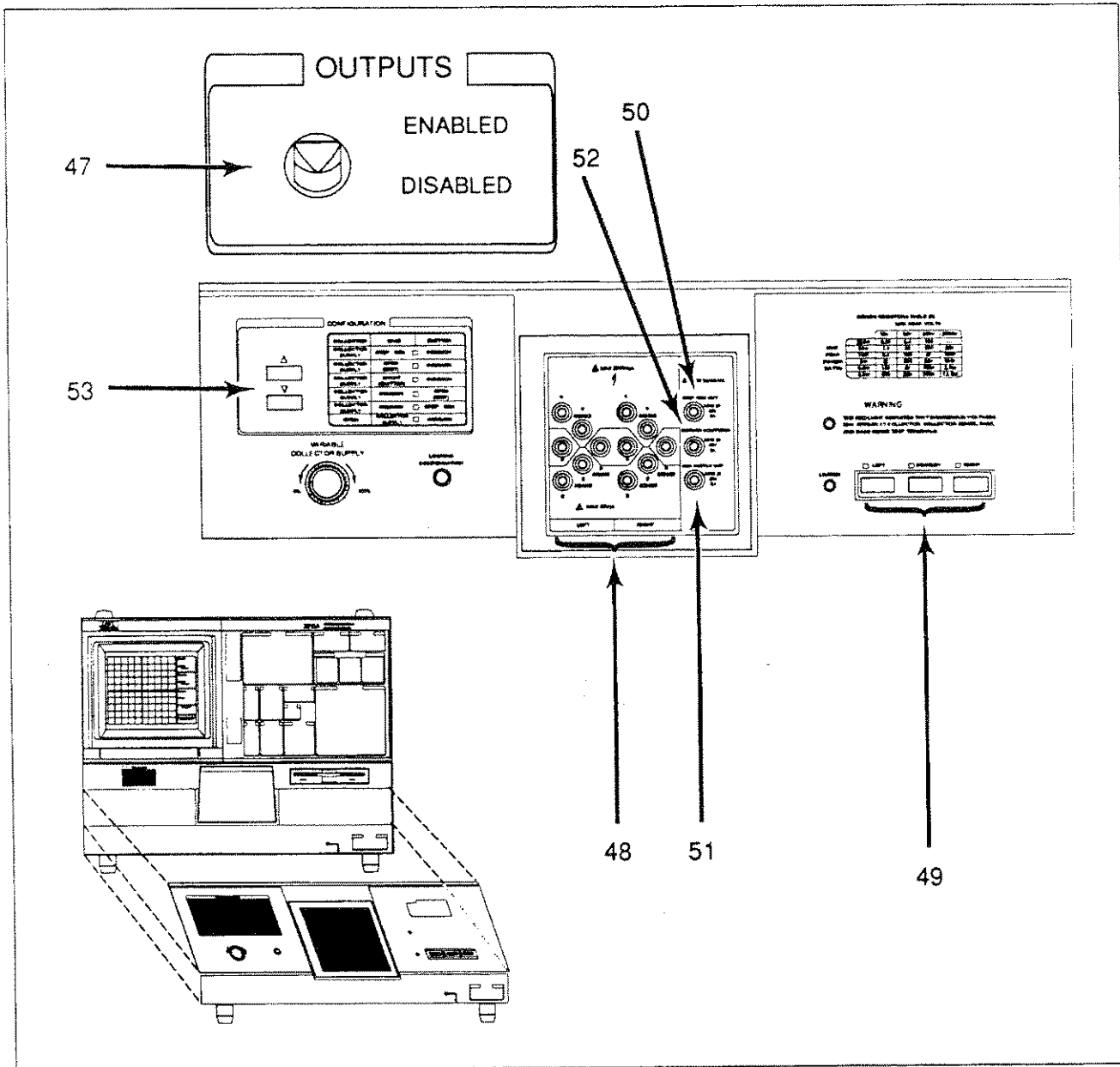

Figure 2-9. Signal Output Controls and Connectors, Configuration Controls and Indicators, and Input Connector.

47 **OUTPUTS.** Enables or disables Collector Supply, Step Generator, and AUX Supply outputs. Too much current automatically trips the breaker to disable outputs.

When the breaker disables the outputs, the **VARIABLE COLLECTOR SUPPLY**, and therefore the output, is reset to 0%. After re-enabling the outputs, the **VARIABLE COLLECTOR SUPPLY** must be reset to the desired level.

AUX SUPPLY CONTROLS, GPIB CONTROLS, FAST/SHIFT, AND FLOPPY DISK DRIVE

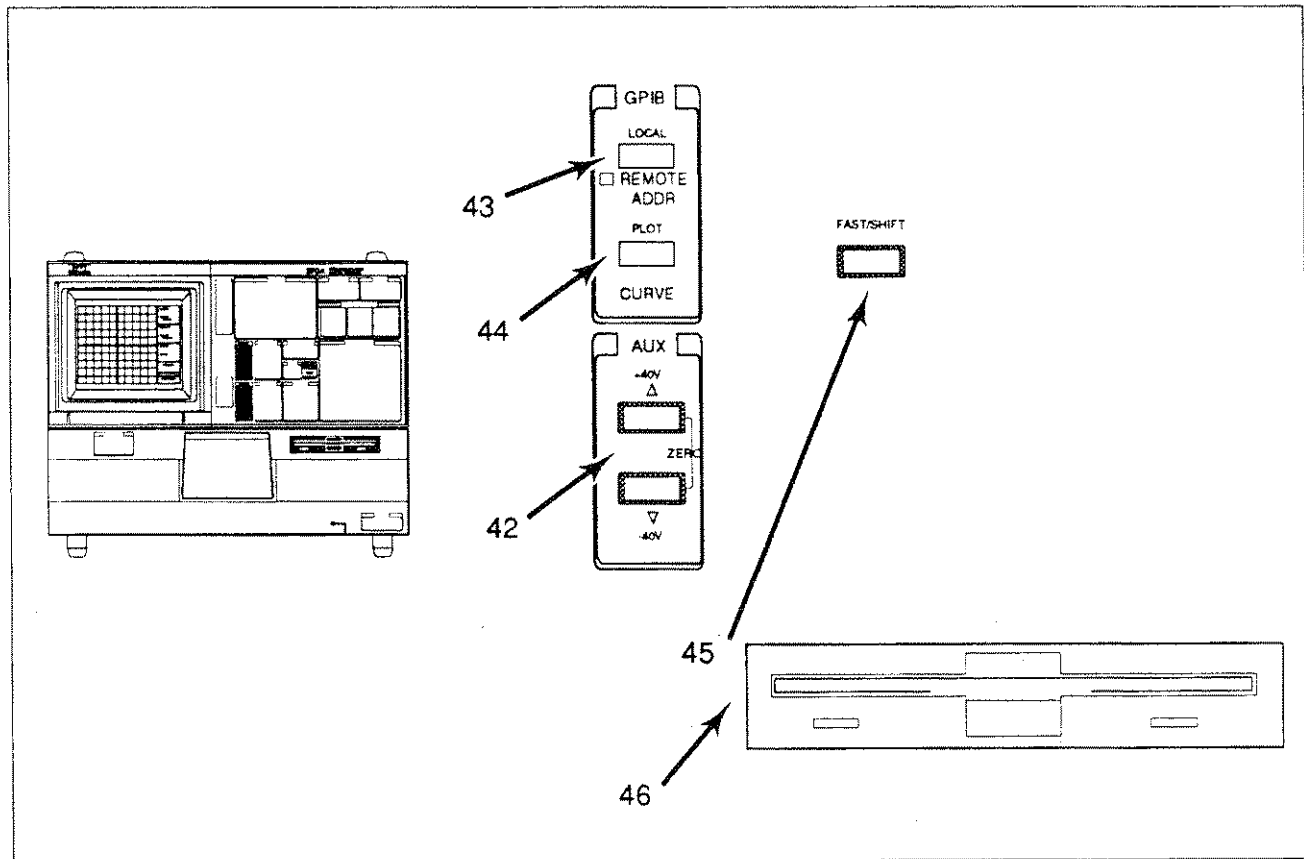

Figure 2-8. Aux Supply , and GPIB Controls, FAST/SHIFT, and Floppy Disk Drive.

42 AUX. The auxiliary voltage supply produces up to ± 40 V at up to 10 mA, or up to ± 20 V at up to 100 mA. The up and down buttons are used to set the auxiliary supply output voltage. The output voltage is supplied to the AUX SUPPLY OUT connector. The auxiliary voltage setting is displayed at the lower left of the crt.

Simultaneously pressing the two buttons sets the auxiliary supply to zero volts and erases the voltage readout.

Holding down the FAST/SHIFT button while pressing either of the AUX buttons causes voltage changes to be in larger increments.

43 LOCAL changes the operating mode of the 370A from remote to local. The instrument is placed in remote operation through the GPIB. When the 370A

is under remote control, the REMOTE LED indicator illuminates.

Pressing the LOCAL button while holding down the FAST/SHIFT button causes the 370A to read the GPIB address and message terminator selections on the rear-panel Configuration Switch Bank. Once received by the internal processor, the selections are displayed on the CRT.

44 PLOT/CURVE. When the PLOT/CURVE button is pressed while the display mode is the STORE or VIEW mode and the appropriate plotter is connected to the Plotter Interface, the 370A sends the appropriate HPGL commands to a plotter via the plotter interface. The plotter receives the HPGL command and starts. The 370A sends the SRQ status via GPIB after the information is sent. Data from CURVE ID, SETUP ID and ERROR MESSAGE are

370A Operator's Manual

not plotted. If PLOT/CURVE is pressed while sending data to a plotter, cancels data sending.

If the PLOT/CURVE button is pressed while pressing the FAST/SHIFT button, only curves are plotted.

45 FAST/SHIFT. Holding down the FAST/SHIFT button while pressing any of the Position Control buttons increases the rate of change.

The FAST/SHIFT button is also used to change the function of other buttons on the 370A front panel. The alternate function is printed in blue below each button.

Table 2-5 shows the buttons with the FAST/SHIFT button operates, and the effect the FAST/SHIFT button has on those buttons.

46 3.5-inch Floppy Disk Drive provides data storage capability. Up to 64 families of curves can be stored or recalled by the ENTER or VIEW button. Up to 64 setups can be stored or recalled by pressing the SAVE or RECALL button. Press eject button to remove diskette. The LED indicator indicates if the disk drive is active. When the red light is on, the drive is either reading from or writing to the disk. When the light is off, the drive is not operating.

CAUTION

Do not remove the disk by pressing the eject button while the LED indicator on.



35 MAX PEAK VOLTS. Select the maximum peak volts of the Collector Supply. The LED indicates the selected maximum peak volts. When the MAX PEAK VOLTS setting is changed, the Collector Supply output automatically goes to 0%. When the CONFIGURATION mode is BASE COLLECTOR SUPPLY, the available MAX PEAK VOLTS setting is ≤ 400 V.

36 MAX PEAK POWER WATTS. The LED indicates the selected MAX PEAK POWER WATTS. These controls do not affect the Variable Collector Supply output. When MAX PEAK VOLTS is set to 2000 V, the available maximum peak power is ≤ 50 W. The relationship between MAX PEAK POWER and SERIES RESISTORS is shown in Table 2-3.

Table 2-3
Max Peak Power vs. Series Resistors

	16V	80V	400V	2000V
220 W	0.26 Ω	6.4 Ω	160 Ω	
50	1.3	32	800	20 k Ω
10	6.4	160	4K	100K
2	32	800	20K	500K
0.4	160	4K	100K	2.5M
0.08	800	20K	500K	12.5M



37 POLARITY. There are seven collector supply polarity modes:

+LEAKAGE
+DC
+ 
AC
- 
-DC
-LEAKAGE

The LED indicates the selected mode. When the Collector Supply polarity is changed or switched to or from AC, the Collector Supply output automatically goes to 0%. Trace origin is at graticule lower left corner when a plus mode is selected, at graticule center when AC is selected, and at graticule upper right corner when a minus mode is selected.

+LEAKAGE and -LEAKAGE: Vertical sensitivity is increased 1000 times. Vertical amplifier measures emitter current. Collector Supply mode is automatically set for DC voltage output. The number of steps is automatically set to 0 and the Step Generator output consists of offset only.

+DC and -DC: When +DC or -DC is selected, the collector supply applies a dc voltage equal to the peak value set by the VARIABLE COLLECTOR SUPPLY control.

+  and - : When either is selected, a full-wave rectified sine wave of + or - polarity, respectively is applied to the collector or base terminals and either a positive or negative staircase is applied to the base or emitter terminals from the step generator.

AC: Selecting ac polarity applies a sinusoidal voltage to the collector or base terminals. The step generator output is positive-going.

38 LOOPING COMPENSATION neutralizes the effects of internal and adapter stray capacitance. Does not compensate for device capacitance.

39 VARIABLE COLLECTOR SUPPLY allows variable control of collector supply voltage within range set by MAX PEAK VOLTS controls. Clockwise (cw) rotation increases the collector supply output voltage, and ccw rotation decreases it. The control has no stops. The output voltage is indicated in the % of COLLECTOR PEAK VOLTS area of the display as a percent of MAX PEAK VOLTS.



NOTE

When the 370A is in DC mode, and the Variable Collector Supply is rotated quickly from 100% to 0%, or the OUTPUT is switched to DISABLED, a "bounce" effect may be observed, where the cursor goes to 0, then jumps back to as much as 3V when the instrument is in the 400V range, and slowly returns to 0. This is normal.

40 WARNING. Red light indicates that the collector supply is enabled and dangerous voltage is applied to the collector or base terminals.

41 LIMITER. Indicates that the automatic protection is operating. The protection circuit limits the Collector Supply output.

Table 2-4
 Collector Supply Polarity Functions.

POLARITY	Vertical Display Source	Collector Supply Output	Number of Steps
+LEAKAGE	Emitter	+DC	0
+DC	Collector	+DC	as selected
+ 	Collector	+rectified sine wave	as selected
AC	Collector	sine wave	as selected
- 	Collector	-rectified sine wave	as selected
-DC	Collector	-DC	as selected
-LEAKAGE	Emitter	-DC	0

■ READOUT DISPLAY

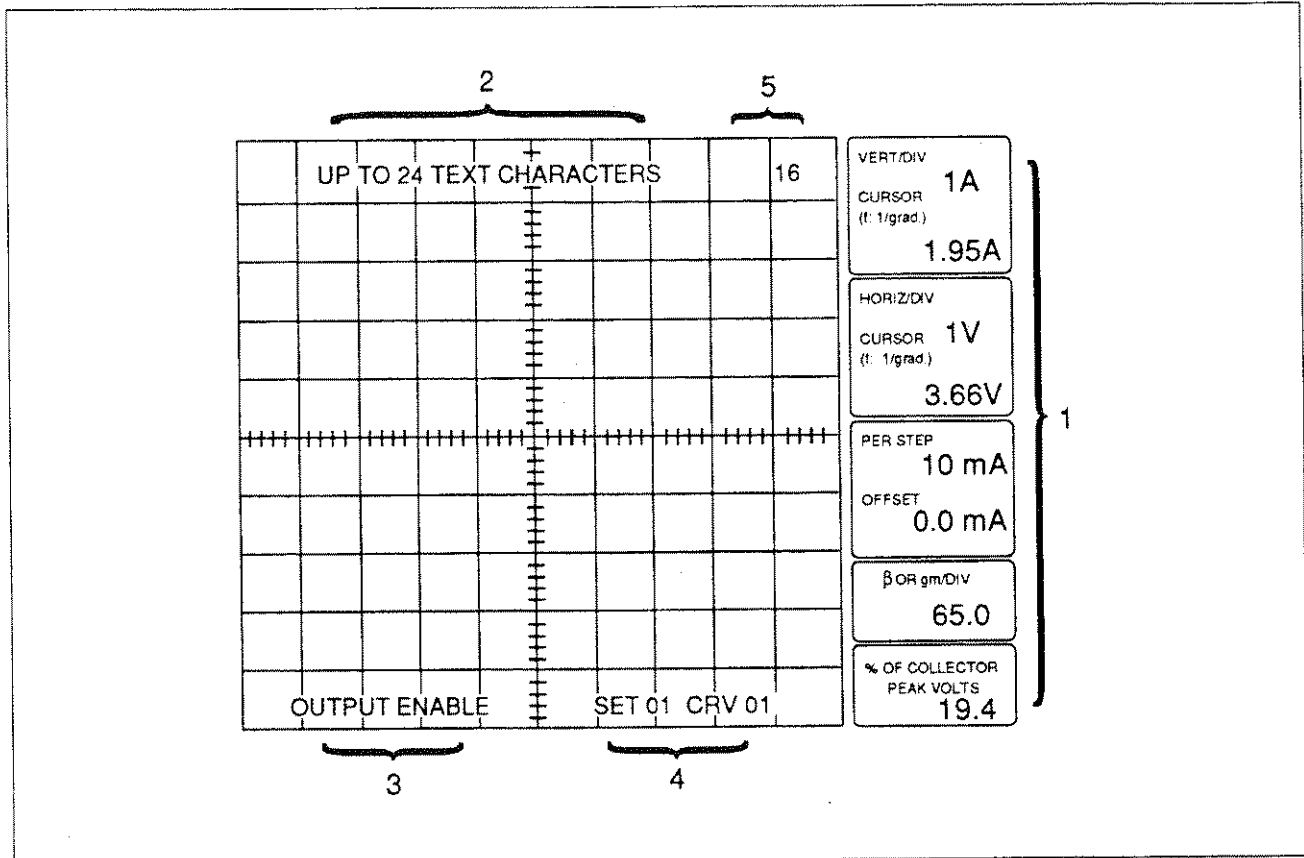

Figure 2-11. Readout Display.

The 370A crt has an internal printed graticule and characters (VERT/DIV, HORIZ/DIV, etc.) for internal setups.

GRAT ILLUM controls the brightness of the graticule and printed characters. Figure 2-X illustrates the screen readout areas. The types of readout information are:

- Setup Readout
- Text
- Error Message
- Curve/Setup ID
- Display Offset
- Average Count
- AUX Supply Voltage

1 Setup Readout. The appropriate readouts for VERT/DIV, PER/STEP, OFFSET, % OF COLLECTOR, PEAK VOLTS, cursor measurement readouts for vertical and horizontal, and the β or gm/div readout are displayed on each column.

When the REF curve is displayed, readout data of the STORE or VIEW curve are displayed. When the Step Generator source is selected, the VERT/DIV or HORIZ/DIV readout disappears.

2 Text. To identify the stored curves or front-panel settings, the text message can be written on the top of the crt graticule area.

No more than 24 characters can be written in the text area. The 370A recognizes lower-case "u" as μ and displays the Greek letter "u" instead.

370A Operator's Manual

Text can be stored with the VIEW curve data or the setup data in the mass storage.

3 Error Message and AUX Supply Voltage. The error messages (operation error, I/O error, emergency error, etc.) are displayed on this area (14 characters maximum) for approximately five seconds and are then automatically deleted.

The auxiliary supply setting is displayed except when the auxiliary supply is set to 0 volt.

4 Curve/Setup ID and Display Offset. The memory location of the curve currently displayed is identified by pressing the VIEW button. This memory index number is called the Curve ID.

The memory location of the setup information for the currently displayed curve is identified on the display by pressing the RECALL button. This memory index number is the Setup ID.

The Curve ID and Setup ID are removed from the display when a front-panel setting is changed or after 5 seconds have elapsed.

The display offset readouts for vertical and horizontal is displayed on this area except when both the vertical and horizontal display offset is set to zero.

5 Average Count. The number of counts averaged is displayed in this area when the AVG function is selected and operating.

Collector Supply

1. Turn the VARIABLE COLLECTOR SUPPLY control until the diagonal trace reaches graticule center. Set the MAX PEAK POWER WATTS to 220. Note that the diagonal trace lengthens as the wattage is increased. Refer to the SERIES RESISTORS TABLE on the front panel. Note that the series resistor decreases as the maximum peak power is increased.
2. Set the OUTPUTS breaker to the DISABLE position, then open the protective cover.
3. Replace the resistor in the diode adapter with a silicon diode. Connect the diode cathode to the adapter emitter terminal. Close the protective cover.
4. Observe that the Memory Index is set to 1, then press the Setup RECALL button.
5. Set the 370A controls as follows:

LEFT-RIGHT-STANDBY VERTICAL CURRENT/DIV and HORIZONTAL VOLTS/DIV	RIGHT To appropriate values (depending on the forward current and forward voltage rating of the diode).
CONFIGURATION	BASE = SHORT (EMITTER), EMITTER=COMMON
6. Set the OUTPUTS breaker to the ENABLED position.
7. Turn the VARIABLE COLLECTOR SUPPLY control clockwise. Note the display of the forward voltage characteristic of the diode (see Figure 3-3).
8. Use the Cursor selection buttons to select the DOT cursor. A high-intensity dot will be displayed on the characteristic curve. If the dots not appear, adjust the NON STORE/STORE/VIEW intensity control.
9. Use the Position Control buttons to move the dot cursor into the on-state region.

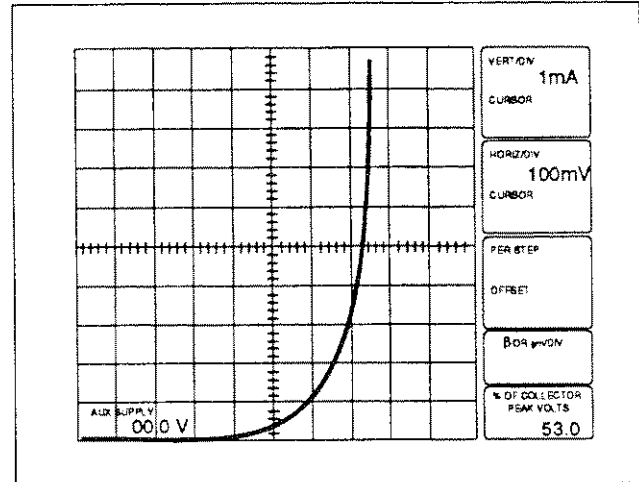

Figure 3-3. Display of signal diode forward-bias characteristics.

10. Use the Cursor selection buttons to select the f LINE cursor. If the f Line cursor does not appear, adjust the READOUT/CURSOR intensity control.
11. Use the Position Control buttons to change the slope of the f line cursor until it is tangent to the curve. The CURSOR (f:1/grad) readout indicates the on-state resistance of the diode.
12. Change the 370A settings as follows:

Cursor Mode	OFF
Collector Supply	POLARITY+ DC
13. Adjust the trace intensity and turn the VARIABLE COLLECTOR SUPPLY control clockwise. Note that the display of the forward voltage diode characteristic is now a spot, which indicates the current conducted by the diode and the voltage across the diode.
14. Turn the VARIABLE COLLECTOR SUPPLY control counterclockwise. Note that the spot traces out the diode characteristic curve.
15. Change the 370A settings as follows:

Collector Supply POLARITY	- (full-wave)
VERTICAL CURRENT/DIV, HORIZONTAL VOLTS/DIV, and Collector Supply MAX PEAK VOLTS	To appropriate values for the reverse current and reverse breakdown voltage of the diode

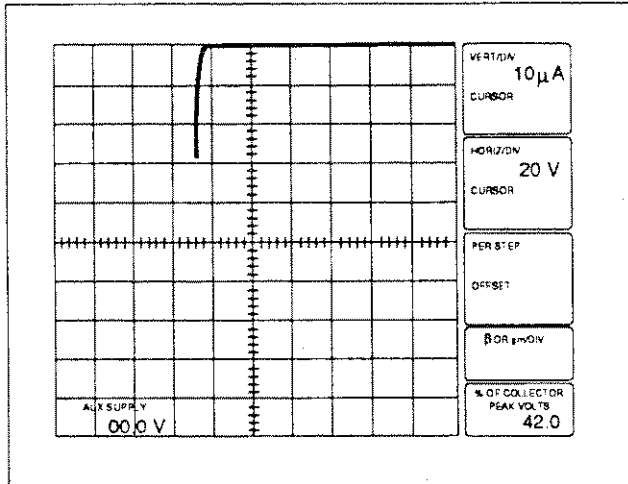

Figure 3-4. Display of signal diode reverse-bias characteristics.

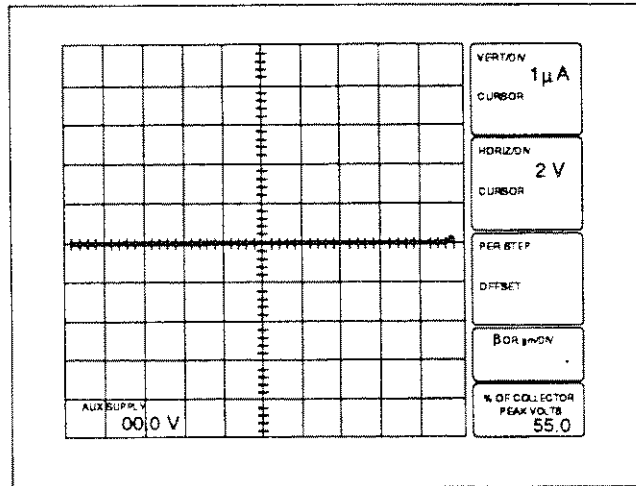

Figure 3-5. Adjustment of LOOPING COMPENSATION control.

16. Rotate the VARIABLE COLLECTOR SUPPLY control clockwise and adjust the trace intensity. Note the display of the reverse voltage characteristic of the diode (see Figure 3-4).

17. Reduce the intensity, then reset the following controls:

LEFT-RIGHT-STANDBY	LEFT
Display Mode	NON STORE
VERTICAL CURRENT/DIV	1 μ A
HORIZONTAL VOLTS/DIV	2 V
Collector Supply	
POLARITY	AC
MAX PEAK VOLTS	16

18. Turn the VARIABLE COLLECTOR SUPPLY control to 100%, adjust the trace intensity for a visible display, and adjust the LOOPING COMPENSATION control for minimum trace width (see Figure 3-5). Use the TRACE ROTATION control to align the trace with the horizontal graticule line.

19. Set the OUTPUTS breaker to the DISABLED position, then open the protective cover.

20. Replace the diode in the diode adapter with an Zener diode. Connect the diode cathode to the emitter terminal. Close the protective cover.

21. Observe that the Memory Index is set to 1, then press the Setup RECALL button to initialize the 370A.

22. Change the 370A settings as follows:

LEFT-RIGHT-STANDBY	RIGHT
Collector Supply POLARITY	AC
VERTICAL CURRENT/DIV and HORIZONTAL VOLTS/DIV	To appropriate values for the breakdown of the Zener diode.
CONFIGURATION	BASE = SHORT (EMITTER), EMITTER = COMMON

23. Set the OUTPUTS breaker to the ENABLED position.

24. Turn the VARIABLE COLLECTOR SUPPLY control clockwise. Note that the display shows both the forward and reverse characteristics of the Zener diode (see Figure 3-6A).

25. Use the Cursor selection buttons to select the DOT cursor, and use the Position Control buttons to move the cursor to the desired breakdown current level.

The vertical CURSOR readout gives the current level and the horizontal CURSOR readout gives the breakdown voltage (see Figure 3-6B).

Table 3-1
Default Setup

CONTROL	DEFAULT
MEASUREMENT	REPEAT
DISPLAY Mode VERTICAL HORIZONTAL INVERT	STORE COLLECTOR 2A (displayed on the CRT READOUT) COLLECTOR 2V (displayed on the CRT READOUT) NOT INVERT (LED OFF)
ACQ MODE	NORM
MAG	OFF
MEMORY INDEX	1
STEP GENERATOR Output Mode POLARITY STEP AMPLITUDE STEP MULTI .1X OFFSET PULSE NUMBER OF STEPS	CURRENT +, NOT INVERTED (LED OFF) 50 nA (displayed on the CRT READOUT) NOT MULTIPLIED (LED OFF) ZERO 0.0 nA (displayed on the CRT READOUT) OFF 5
CURSOR	OFF
POSITION Mode	CURSOR
GPIB LOCAL/REMOTE	LOCAL (LED OFF)
AUX SUPPLY	0.00 V
COLLECTOR SUPPLY MAX PEAK VOLTS MAX PEAK POWER WATTS POLARITY VARIABLE COLLECTOR SUPPLY	16 0.08 +  0.0%
CONFIGURATION	BASE = STEP GEN EMITTER = COMMON
LEFT - RIGHT - STANDBY	STANDBY

- Allow the instrument to warm up for a few minutes.
- Press SAVE to store the default settings in memory location #1. These are used as a starting point for each major step throughout the procedure, so that you do not lose your place.

CRT and Readout Controls

- Turn the NON STORE/STORE/VIEW INTENSITY control clockwise until a spot appears at the lower left corner of the CRT graticule. To avoid burning the CRT phosphor, adjust the NON STORE/STORE/VIEW INTENSITY control until the spot is just visible.
- Turn the READOUT/CURSOR INTENSITY control throughout its range. Note that the readout becomes brighter as the control is turned clockwise. Set the control for the desired readout brightness. The initial displayed control settings should be: 2A VERT/DIV, 2V HORIZ/DIV, 50nA PER STEP, 0.0nA OFFSET, 40M β OR gm/DIV, and 0.0 % of COLLECTOR PEAK VOLTS.
- Turn the FOCUS control throughout its range. Adjust the FOCUS control for a well-defined spot.
- Turn the GRAT ILLUM control throughout its range. Note that the graticule lines and the readout titles illuminate as the control is turned clockwise. Set the control for desired illumination.

Positioning Controls

1. Press the NON STORE button while holding down the FAST/SHIFT button. This changes the NON STORE button function to CAL ZERO.
2. Rotate the vertical POSITION control to align the displayed dot with the bottom graticule line.
3. Rotate the horizontal POSITION control to align the displayed dot with the left graticule border.
4. Press the REF button while holding down the FAST/SHIFT button. This changes the REF button function to CAL FULL.
5. Observe that the dot is displayed at the upper right corner of the display graticule.
6. Press the STORE button while holding down the FAST/SHIFT button. This changes the STORE button function to CAL OFF.
7. Press the Display INVERT button.
8. Observe that the dot is displayed in the upper right corner of the display graticule.
9. Press the Display INVERT button again to resume normal operation.

5. Set the LEFT-RIGHT-STANDBY control to RIGHT and turn the VARIABLE COLLECTOR SUPPLY control until a trace appears diagonally across the CRT. Adjust the trace intensity for a visible trace.
6. Rotate the VERTICAL control clockwise and note that as the vertical deflection factor decreases, the line slope increases (see Figure 3-2). Turn the VERTICAL control counterclockwise from the 1 mA position and note the decreasing slope. Also note that the VERT/DIV readout changes in accordance with the position of the VERTICAL control. Reset the VERTICAL control to 1 mA.

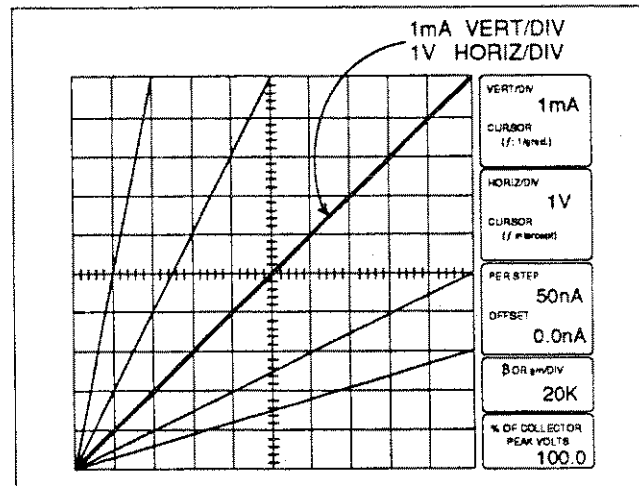

Figure 3-2. Display of I vs. E for 1 k resistor.

Vertical and Horizontal Sensitivity

1. Install the diode adapter (A1005) into the right-hand set of adapter connectors.
2. Install a 1 k Ω , 1/2 watt resistor in the diode adapter and close the plastic protective cover.
3. Reset the following 370A controls:

VERTICAL	1 mA
HORIZONTAL	1 V COLLECTOR
4. Set the OUTPUTS breaker to the ENABLED position.

7. Rotate the HORIZONTAL control clockwise and note that as the horizontal deflection factor decreases, the line slope decreases (see Figure 3-2). Turn the HORIZONTAL control counterclockwise from the 1 V position and note the change in slope. Also note that the HORIZ/DIV readout changes as the HORIZONTAL control is rotated. Reset the HORIZONTAL control to 1 V.
8. Press DISPLAY INVERT (red LED turns on) and rotate the VARIABLE COLLECTOR SUPPLY control first counterclockwise, then clockwise. Note that the display is now inverted and originates in the upper right corner of the graticule. Press the DISPLAY INVERT button (red LED turns off).

3

Operating Instructions

GENERAL DESCRIPTION OF INSTRUMENT OPERATION

The 370A is a microprocessor-controlled semiconductor tester that displays and allows measurement of both static and dynamic semiconductor characteristics obtained under simulated operating conditions. The Collector Supply and Step Generator produce voltages and currents that are applied to the device under test. The display amplifiers measure the effects of these applied conditions on the device under test. The result is a family of characteristics curves traced on the CRT.

The Collector Supply circuit normally produces a full-wave rectified sine wave that can be either positive- or negative-going. The amplitude of the signal can be varied from 0 to 2000 volts, as determined by the MAX PEAK VOLTS controls and the VARIABLE COLLECTOR SUPPLY control. The Collector Supply output is applied to either the collector or the base (or equivalent) terminal of the device under test. The Step Generator produces ascending steps of current or

voltage at a normal rate of one step per cycle of the Collector Supply. The amount of current or voltage per step is controlled by the STEP AMPLITUDE control and the total number of steps is controlled by the NUMBER OF STEPS controls. This Step Generator output can be applied to either the base or the emitter (or equivalent) terminals of the device under test. The display amplifiers are connected to the device under test. These amplifiers measure the effects of the Collector Supply and of the Step Generator on the device under test, amplify the measurements and apply the resulting voltages to the deflection plates of the CRT. Display amplifier sensitivity is controlled by the VERTICAL CURRENT/DIV control and the HORIZONTAL VOLTS/DIV control. Figure 3-1 is a block diagram showing the connection of these circuits to the device under test for a typical measurement.

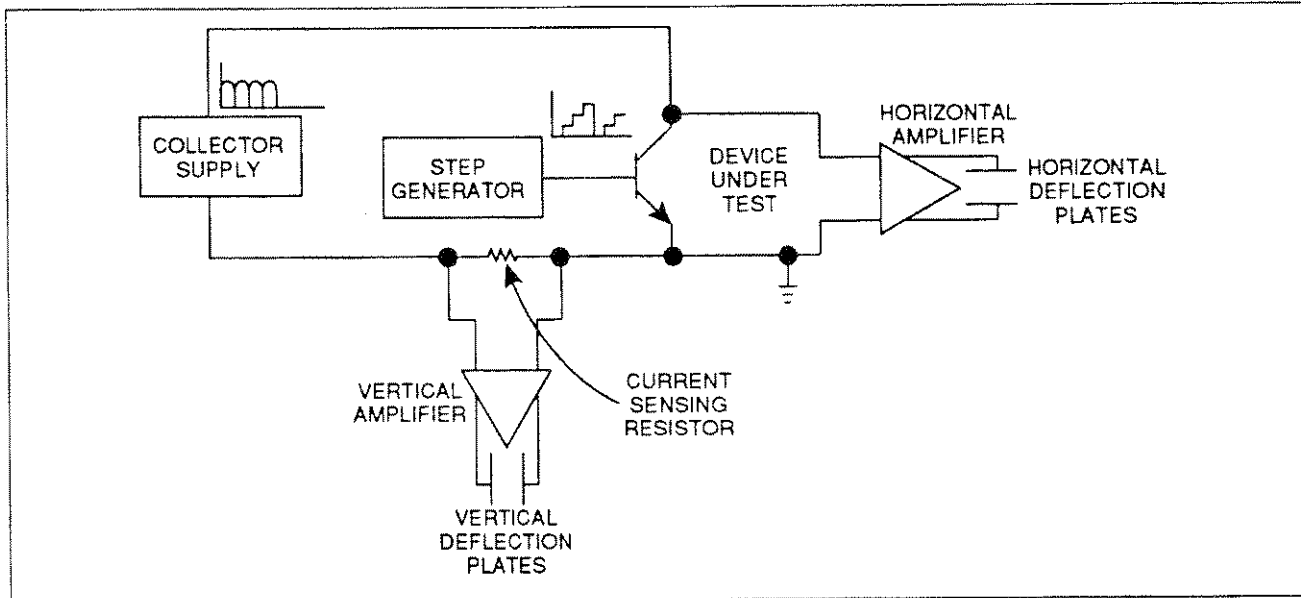

Figure 3-1. 370A Block Diagram.

■ FIRST TIME OPERATION

When the 370A is received, it is calibrated and should perform within the specification shown in Section 1. The following procedure allows the operator to become familiar with the front panel controls, their function, and how they are used in performing semiconductor measurements. This procedure can also be used as a general check of instrument performance. To check instrument operation to the specification in Section 1, refer to the PERFORMANCE CHECK and ADJUSTMENT PROCEDURE (370A Service Manual).

NOTE

In the following procedure, several figures depict displayed waveforms. When attempting to duplicate the displays while using this procedure, remember that devices differ, and the display depicted will likely be different than the one on your 370A.

Power On Diagnostics

1. Set the OUTPUTS breaker to the DISABLED position.
2. Apply power to the 370A. The 370A starts SELFTEST. During SELFTEST, the LED front-panel indicators go through the following sequence:
 - a) The MEMORY index and NUMBER OF STEPS displays are set to 10 and the message "SELFTEST START" is displayed in the error message area of the CRT.
 - b) The MEMORY index count down to 0, then the NUMBER OF STEPS count down to 0.

This sequence takes about 10 seconds. If the Power-on Diagnostics detect no error, the message "SELFTEST PASS" is displayed on the error message area of the CRT. The 370A then configures to the default setup. Table 3-1 lists the default conditions of the 370A. The CRT controls and LOOPING COMPENSATION control are not set at power-up.

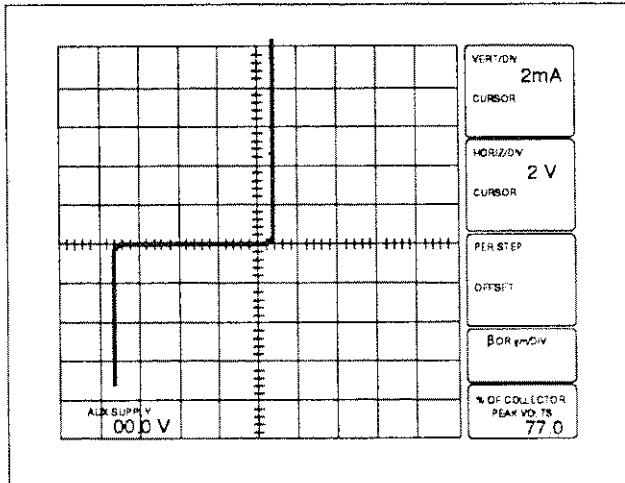

Figure 3-6(A). Display of Zener diode I vs. E characteristic

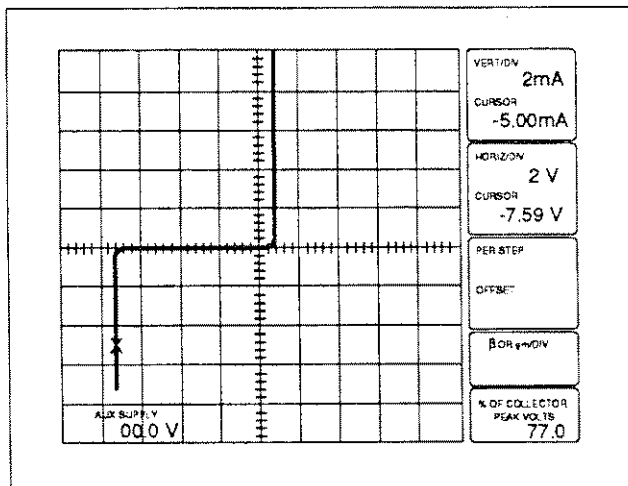

Figure 3-6(B). Measuring breakdown voltage with the Dot cursor.

Display Offset and Magnifier

1. Press the Position DISPLAY button and press RIGHT Position button until the Zener breakdown portion of the display is within 0.1 division of the center vertical line. Note that the vertical and horizontal offset values are displayed at the bottom right of the CRT. Multiply the horizontal offset readout by the HORIZ/DIV readout to calculate the approximate breakdown voltage of the Zener diode.
2. Set the MAG control to X10 position. Note that the VERT/DIV and HORIZ/DIV readout value has changed to indicate the 10 times multiplication. By expanding the scale, a more precise measurement can be made.

Step Generator

1. Set the OUTPUTS breaker to the DISABLED position, then open the protective cover.
2. Remove the diode adapter (A1005) and replace it with a transistor adapter (A1007).
3. Place an NPN silicon transistor into the right transistor test socket of the transistor adapter.
4. Close the protective cover.
5. Observe that the Memory Index is set to 1, then press the Setup RECALL button to initialize the 370A.
6. Set the 370A controls as follows:

LEFT-RIGHT-STANDBY	RIGHT
VERTICAL CURRENT/DIV	About 1/10 of the rated collector current
HORIZONTAL VOLTS/DIV	1 V COLLECTOR
7. Set the OUTPUTS breaker to the ENABLED position.

370A Operator's Manual

8. Turn the VARIABLE COLLECTOR SUPPLY control clockwise until the peak collector-emitter voltage is about 10 volts.
9. Turn the STEP AMPLITUDE control clockwise until a step waveform appears on the CRT. Note that the DUT collector current is proportional to the step waveform amplitude. Set the STEP AMPLITUDE for a 0.5 to 1-division step waveform.
10. Be sure the MAX PEAK POWER WATTS is set within the power dissipation rating of the transistor under test. Set the NUMBER OF STEPS to 10. Note the display of collector current vs collector-emitter voltage for ten different values of base current (see Figure 3-7).
11. Change the Memory Index setting to 2, then press the Setup SAVE button to save the front-panel settings for later use.
12. Press the STEP MULTI .1X button and observe that the collector current decreases as the step amplitude is reduced to one-tenth of its previous setting.
13. Press the STEP MULTI .1X button and again to resume normal operation.
14. Press the NON STORE button and the Measurement SINGLE button. Note that each time the SINGLE button is pressed, a single family of characteristic curves is displayed.

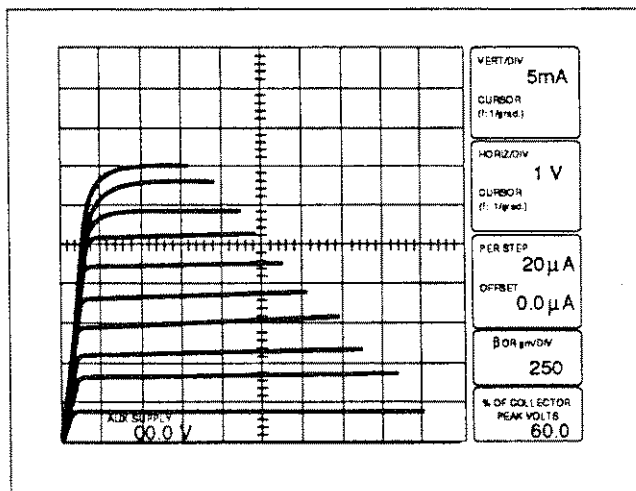

Figure 3-7. IC vs. VCE for 10 steps of base current.

15. Change the following 370A settings:

Display Mode	STORE
MEASUREMENT	REPEAT
Step Generator	PULSE LONG

16. Note that the collector supply is in the DC mode and that the steps are displayed as a diagonal array of dots on the CRT screen. Readjustment of the display intensity may be necessary.
17. Press the Measurement SWEEP button. The Collector Supply voltage is increased from 0% to the previously-set value, resulting in series of dots representing the collector current vs. collector-emitter voltage characteristic.
18. Set the Step Generator PULSE control to OFF and the HORIZONTAL control counterclockwise to 100 mV BASE/EMITTER. Note the display of the collector current vs base-emitter voltage for ten different values of base current (see Figure 3-8).

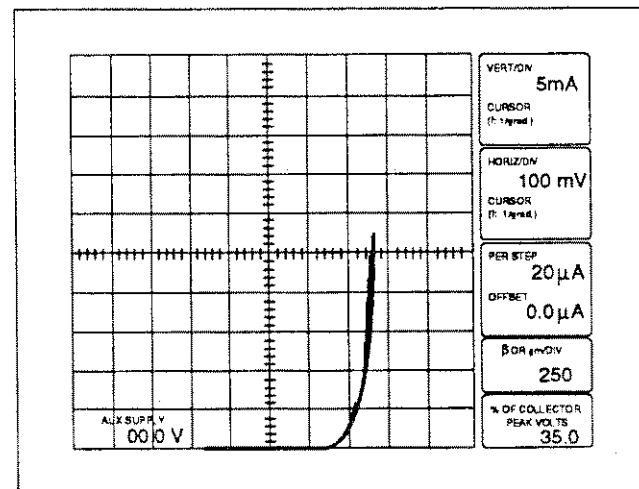

Figure 3-8. IC vs. VBE for 10 steps of base current.

19. Set the HORIZONTAL control counterclockwise to STEP GEN. Note the display of collector current vs base-current, one step per horizontal division (see Figure 3-9).

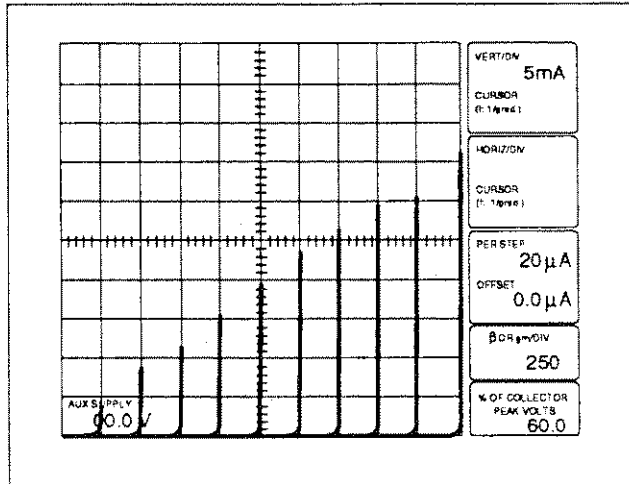

Figure 3-9. IC vs. IB

20. Set the VERTICAL control counterclockwise to STEP GEN and the HORIZONTAL control clockwise to 1 V COLLECTOR. Note the display of the base current (one step per vertical division) vs the collector-emitter voltage (see Figure 3-10).
21. Set the OUTPUTS breaker to the DISABLED position.

NOTE

The following ten steps require the optional FET adapter. If you do not have an adapter on hand, either proceed to step 32, or insert a long-lead FET into the transistor adapter with the source, gate, and drain leads corresponding to the emitter, base and collector leads.

22. Open the protective cover, then remove the transistor adapter. (Leave the transistor in the adapter). Install the A1009 FET adapter (optional) in the front-panel jacks and place an N-channel junction FET into the right test socket of the adapter. If you have no A1009 FET adapter, use the A1007 adapter, inserting D,G, and S leads into C,B, and E sockets, respectively.
23. Close the protective cover.
24. Change the Memory Index to 1, then press the Setup RECALL button to initialize the 370A.

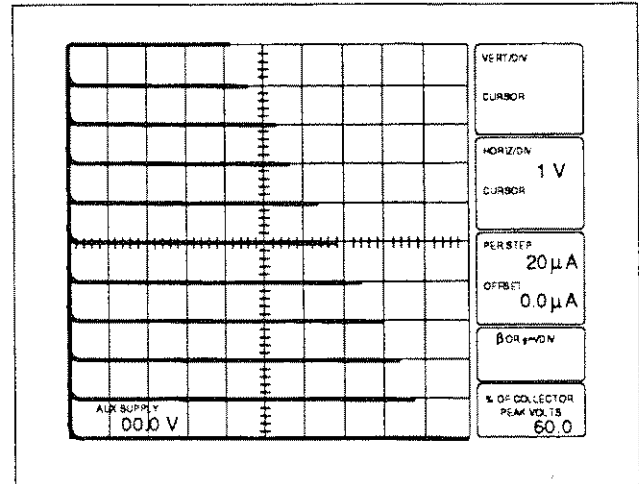

Figure 3-10. IB vs. VCE.

25. Set the 370A controls as follows:

LEFT-RIGHT-STANDB	RIGHT
VERTICAL CURRENT/DIV	About 1/10 of the rated drain current
Step Generator	
Output Mode	VOLTAGE
STEP AMPLITUDE	To appropriate value (depending on the characteristic of the FET)
Collector Supply	
MAX PEAK POWER WATTS	Within the power dissipation rating of the transistor

26. Set the OUTPUTS breaker to the ENABLED position.
27. Turn the VARIABLE COLLECTOR SUPPLY control slowly clockwise. Note the display of drain current vs drain-source voltage with voltage steps applied to the gate (see Figure 3-11). Since the steps applied to the gate are positive-going, the curves displayed represent enhancement mode operation of the FET. (Set number of steps to zero to display the curve obtained with zero volts applied to the gate, then set number of steps to 10.)
28. Press the Step Generator POLARITY INVERT button (red LED turns on) and note the display of the depletion mode of FET operation. Press the Step Generator POLARITY INVERT button for a normal display.

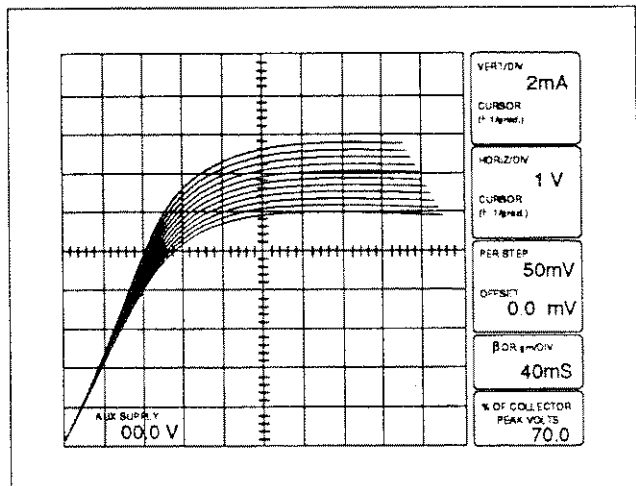



Figure 3-11. Display of FET common-source characteristic curves: I_D vs V_{DS} for 10 steps of gate voltage.

29. Set the OUTPUTS breaker to the DISABLED position, then open the protective cover.
30. Remove the FET test adapter and replace it with the A1007 transistor test adapter (with the transistor still installed).
31. Close the protective cover.
32. Making sure that the Memory Index is set to 1, press the Setup RECALL button to initialize the 370A.
33. Set the 370A controls as follows:

LEFT-RIGHT-STANDBY	RIGHT
VERTICAL CURRENT/DIV	About 1/10 of the rated collector current
HORIZONTAL VOLTS/DIV	1 V COLLECTOR
Collector Supply	
MAX PEAK POWER WATTS	Within the power dissipation rating of the transistor

34. Set the OUTPUTS breaker to the ENABLED position.
35. Turn the VARIABLE COLLECTOR SUPPLY control clockwise for a full-length trace, then turn the STEP AMPLITUDE control clockwise until a

step waveform appear on the CRT. Set the STEP AMPLITUDE for a 1 to 2 division step waveform.

36. Use the Cursor selection buttons to select the DOT cursor.
37. Use the Position Control buttons to move the cursor to the desired point on the characteristic curve (see Figure 3-12). The figure now displayed in the β OR gm/DIV readout is the hFE of the device under test.
38. Use the Cursor selection buttons to select the  Window cursor.
39. Use the Position Control buttons (up, down, left, right) to position the bright dot, in the lower left corner of the cursor window, at any point on the characteristic curve.
40. Use the Cursor selection buttons to select the  Window cursor.
41. Press the left Position Control button to narrow the Cursor window into a straight vertical line.
42. Use the up or down Position Control buttons to position the cursor's bright dot on an adjacent characteristic curve (see Figure 3-13). The figure now displayed in the β OR gm/DIV readout is the hFE of the device under test.

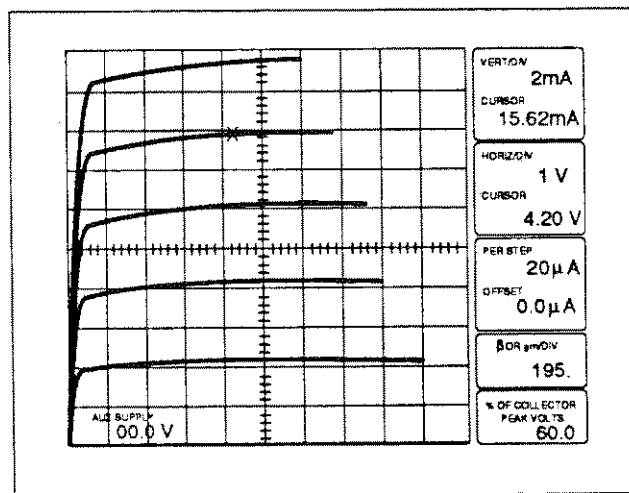

Figure 3-12. Measuring hFE with the Dot cursor.

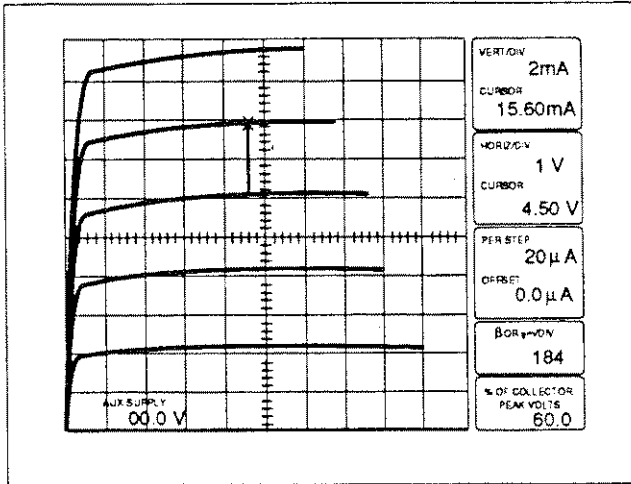

Figure 3-13. Measuring hFE with the Window cursor.

43. Change the following 370A settings:

Cursor Mode	OFF
Step Generator	
NUMBER OF STEPS	1
Output Mode	VOLTAGE
STEP AMPLITUDE	100 mV

44. Press and hold the OFFSET AID button until a step is just visible on the CRT, and note the offset value (approximately 500 mV). The OFFSET readout indicates the base-to-emitter voltage of the transistor.

Configuration

1. Change the Memory Index to 2, then press the Setup RECALL button.
2. Note the display of characteristic curves with the emitter grounded and current steps applied to the base (see Figure 3-14A).
3. Set the OUTPUTS breaker to the DISABLED position, then open the protective cover. Connect a patch cord with banana plugs on each end between the STEP GEN OUT connector and the EXT BASE or EMITTER IN connector.
4. Close the protective cover.
5. Change the following 370A setting:

CONFIGURATION	BASE = OPEN (EXT)
	EMITTER=COMMON

6. Set the OUTPUTS breaker to the ENABLED position, then turn the VARIABLE COLLECTOR SUPPLY control slowly clockwise. Note a display similar to that seen in Step 2.

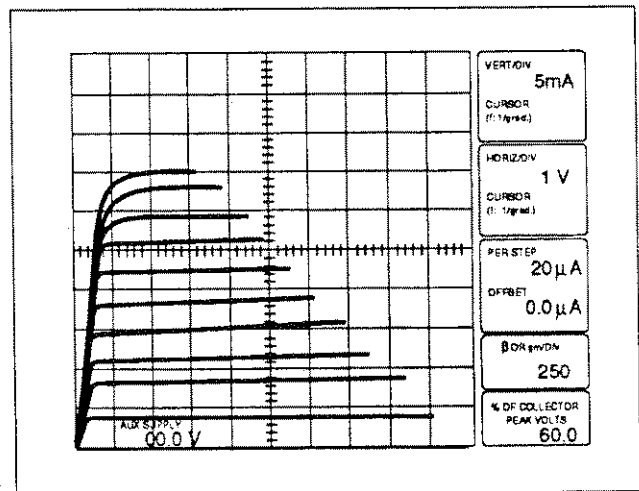

Figure 3-14. (A) CONFIGURATION control set to BASE STEP GEN (NORM).

370A Operator's Manual

7. Set the OUTPUTS breaker to the DISABLED position, then open the protective cover. Remove the patch cord.

8. Close the protective cover.

9. Change the following 370A settings:

Collector Supply	
POLARITY	+LEAKAGE
VERTICAL CURRENT/DIV	1 nA EMITTER

10. Set the OUTPUTS breaker to the ENABLED position.

11. Turn the VARIABLE COLLECTOR SUPPLY control clockwise and note the emitter leakage current display with the base terminal open.

12. Set the CONFIGURATION to BASE = SHORT (EMITTER), EMITTER = COMMON and note the emitter leakage current display with the base terminal shorted to ground.

13. Observe that the Memory Index is set to 2, then press the Setup RECALL button.

14. Change the following 370A setting:

CONFIGURATION	BASE = COMMON, EMITTER=STEPGEN
---------------	-----------------------------------

15. Turn the VARIABLE COLLECTOR SUPPLY control and STEP AMPLITUDE control to display the common-base characteristic curves of the transistor (see Figure 3-14B).

16. Set the OUTPUTS breaker to the DISABLED position, then open the protective cover. Reconnect the patch cord between the STEP GEN OUT connector and the EXT BASE or EMITTER IN connector.

17. Close the protective cover.

18. Change the following 370A setting:

CONFIGURATION	BASE = COMMON, EMITTER = OPEN (EXT)
---------------	---

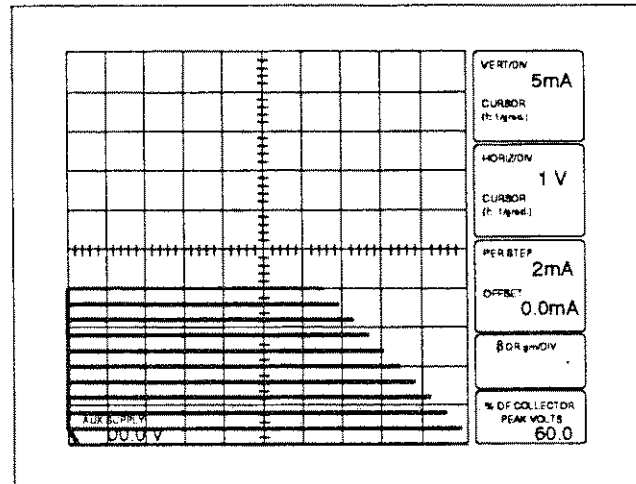

Figure 3-14. (B) CONFIGURATION control set to EMITTER STEP GEN.

19. Set the OUTPUTS breaker to the ENABLED position.

20. Turn the VARIABLE COLLECTOR SUPPLY control clockwise and note a display similar to that seen in step 15.

21. Set the OUTPUTS breaker to the DISABLED position, then open the protective cover. Remove the patch cord.

22. Close the protective cover.

23. Change the following 370A settings:

CONFIGURATION	BASE = COLLECTOR SUPPLY, EMITTER=COMMON
Collector Supply	
POLARITY	-LEAKAGE
VERTICAL CURRENT/DIV	1 nA EMITTER

24. Set the OUTPUTS breaker to the ENABLED position.

25. Turn the VARIABLE COLLECTOR SUPPLY control clockwise and note the base leakage current display with the collector terminal open.

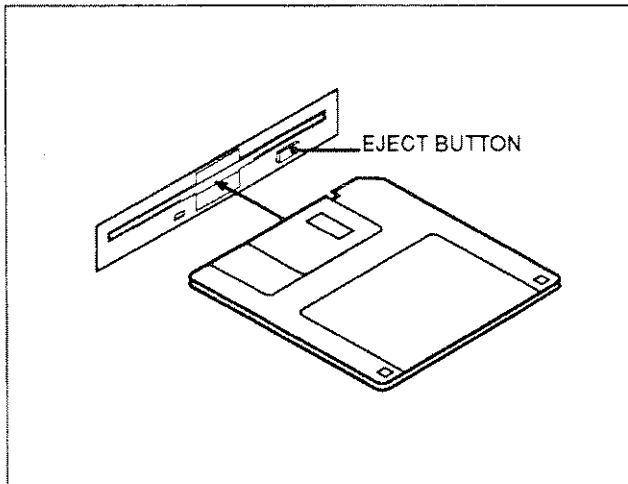

Figure 3-18. Inserting a floppy disk.

6. Press the Display ENTER button. The disk drive indicator flashes for a short period, indicating that the curves being written into the floppy disk.
7. Press the Setup SAVE button to store the front-panel settings in the floppy disk.
8. Set the OUTPUTS breaker to the DISABLED position.
9. Change the Memory Index number to 1, then press the Setup RECALL button to initialize the 370A.
10. Change the Memory Index number back to 17, then press the Display VIEW button.
11. Observe that the curves of step 4 are displayed.
12. Turn the VERTICAL CURRENT/DIV control and observe that the curves disappear from the display.
13. Set the OUTPUTS breaker to the ENABLED position.
14. Press the Setup RECALL button. Observe that the front-panel settings are changed and the curves of step 4 are displayed.

Plotter Output

1. Connect a HPGL-compatible plotter (with an input buffer of at least 8K) to the PLOTTER INTERFACE PORT on the rear panel of the 370A.
2. The display can be plotted in two different modes:

To plot the entire display: Display a characteristic curve, then press the GPIB PLOT button on the front panel.

To plot the characteristic curve only: Display a characteristic curve, then press the GPIB PLOT button while holding down the FAST/SHIFT button.

Plotter output will begin when the GPIB PLOT button is pressed. If the GPIB PLOT button is pressed again during data output via the PLOTTER interface, the output to the plotter will stop.

Erasing the non-volatile IC memory

CAUTION

The following operation ERASE ALL DATA stored in the non-volatile IC memory, not just the data under the current index number. Do not perform this operation if there is any important data stored in the IC memory.

1. Press the display INVERT button while holding down the FAST/SHIFT button. This changes the INVERT button function to ERASE. This function is not printed below the button.

The message "PRESS INVERT" is displayed for about five seconds.

If the Display INVERT button is pressed during this interval, the non-volatile IC memory is erased and the message "ERASE COMPLETE" is displayed.

If the Display INVERT button is not pressed, the erase function is canceled and the message "ERASE CANCELED" is displayed.

GENERAL OPERATING INFORMATION

CRT

The 370A CRT has a permanently-etched, 10 x 10 internal graticule. Illumination of the graticule is controlled by the GRAT ILLUM control. A protective shield for the CRT is fitted between the bezel and the CRT.

A blue filter is provided to improve the contrast of the display under high ambient lighting conditions.

Readout

The readout, located on the right of the graticule and referred to as the Setup Readout, consists of the alphanumeric displays and titles for each. The alphanumeric displays show numbers and units (e.g., 5 mA, 2 V), the values of which are a function of front-panel or GPIB-programmed control settings. The titles are words etched to the CRT. These words indicate the characteristics of the CRT display to which each alphanumeric display is related (e.g., VERT/DIV, PER STEP, etc.). Illumination of the alphanumeric displays is controlled by the READOUT/CURSORS control, and illumination of the titles is controlled by the GRAT ILLUM control. The 370A CRT has six other readouts: TEXT, ERROR MESSAGE, AUX SUPPLY, CURVE/SETUP ID, DISPLAY OFFSET, and AVERAGE COUNT. Illumination of these readout displays is controlled by the READOUT/CURSORS control.

Intensity

The NON STORE/STORE/VIEW intensity control regulates the intensity of the NON STORE, STORE, or VIEW curve. This control should be adjusted so that the display is easily visible but not overly bright. Readjustment may be required for different displays.

CAUTION

Use particular care when displaying a spot. A high-intensity spot may burn the CRT phosphor and cause permanent damage to the CRT.

The intensity of the REF curve is controlled by the REF intensity control, and the intensity of the readouts and the cursors (except the dot) is controlled by the READOUT/CURSORS intensity control. The dot intensity cannot be adjusted independently.



Focus

The focus of the CRT display is controlled by the FOCUS control. This control should be adjusted for optimum display definition.

Vertical Measurement and Deflection Factor

In the vertical dimension, the display on the CRT measures either collector current (IC), base current (IB), emitter current (IE), or the output of the Step Generator. The Collector Supply POLARITY controls, the VERTICAL CURRENT/DIV control, and the CONFIGURATION controls determine which of these measurements are made.

The Vertical deflection factor of the CRT display is controlled by the VERTICAL switch, the MAG control and the Collector Supply POLARITY switches. The VERT/DIV readout CRT combines the effect of these three controls to produce the vertical deflection factor.

Under normal operating conditions, with POLARITY set to + , AC, or -  and MAG set to OFF, collector current is measured vertically, and the VERTICAL control determines the vertical sensitivity of the display.

When measuring collector current, the VERTICAL control provides deflection factors (unmagnified) ranging from 1 μ A/division to 2 A/division. The vertical deflection factor is indicated by the VERT/DIV readout.

Text Editing

1. Observe that the Memory Index is set to 2, then press the Setup RECALL button.
2. Press the Position CURSOR button while holding down the FAST/SHIFT button. This changes the function of the CURSOR button to TEXT.

The message "TEXT EDIT MODE" is displayed at the bottom of the display for about 5 seconds and the text edit cursor is displayed as a box at the top of the display.

3. Press and hold the up Position Control button and observe that characters are displayed at the cursor position in the following sequence:

space,A,B ... Z, space,m,u,n,p,,0,1 ... 9,-,/,*,(,)=

Once displayed, characters remain in place until written over or erased.

4. Press the right Position Control button and left Position Control button, and observe that the cursor moves without altering the display.
5. Use the four Position Control buttons to enter any desired text, consisting of up to 24 characters.
6. Press the FAST/SHIFT button and observe that the character at which the cursor is displayed is erased and the cursor moves to the next position on the left.
7. Press the left and right Position Control buttons simultaneously, and observe that all of the text is deleted.
8. Enter another group of text.
9. Press the CURSOR/TEXT button to exit the Text Edit mode. The text cursor will disappear from the display. The text remain in place.
10. Change the Memory Index number to 3 and press the Display ENTER button.

The entered text and the displayed characteristic curve are both stored.

11. Set the OUTPUTS breaker to the DISABLED position.
12. Change the Memory Index setting to 1 and press the Setup RECALL button to initialize the 370A settings.
13. Observe that the entered text is cleared from the display.
14. Change the Memory Index number back to 3 then press the Display VIEW button.
15. Observe that the curve and previously stored text are displayed.

ACQ Mode (STORE Mode)

1. Change the Memory Index number to 1, then press the Setup RECALL button to initialize the 370A.

2. Set the 370A controls as follows:

LEFT-RIGHT-STANDBY	RIGHT
VERTICAL CURRENT/DIV	About 1/10 of the rated collector current
HORIZONTAL VOLTS/DIV	100 mV BASE/EMITTER
Step Generator	
STEP AMPLITUDE	100 μ A
NUMBER OF STEPS	1
ACQ MODE	HORIZ ENV

3. Set the OUTPUTS breaker to the ENABLED position.

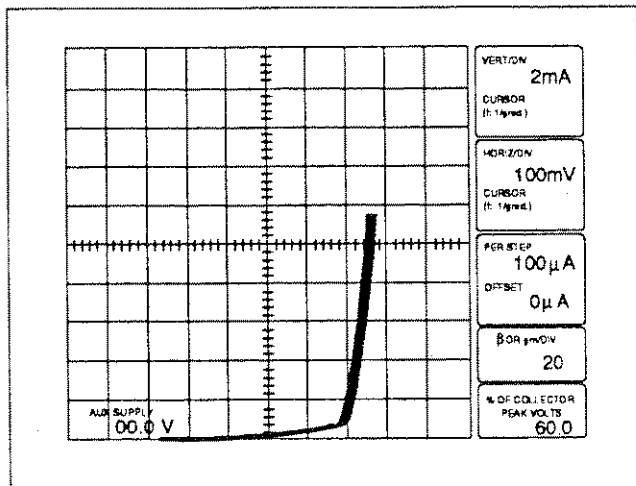

Figure 3-15. Stored envelope display.

4. Turn the VARIABLE COLLECTOR SUPPLY clockwise. Note the envelope display of the collector current vs base-emitter voltage for a value of base current. The display shows a horizontal min/max envelope of the storage display (see Figure 3-15). If you set the ACQ MODE to VERT ENV, a vertical envelope is displayed on the CRT.
5. Set the ACQ MODE to AVG. The averaging count (1 through 16) is displayed at the upper right corner of the CRT (see Figure 3-16), and the acquired curves are averaged.

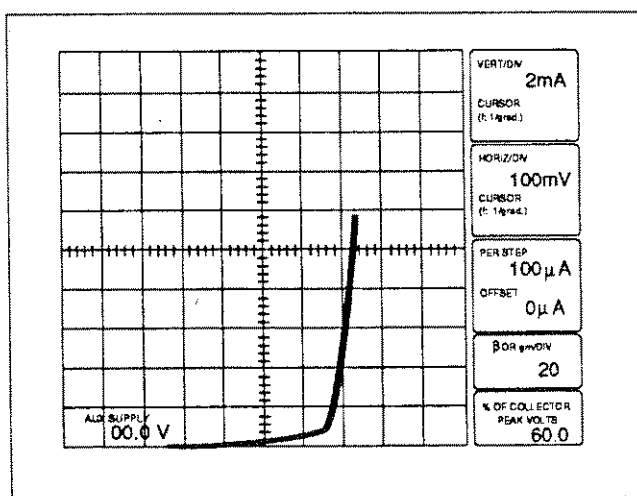

Figure 3-16. Averaging display.

Floppy Disk Drive

1. Obtain a blank 3.5-inch floppy disk (2DD type). If the floppy disk is write protected, move the write protect tab to the write-enable position (see Figure 3-17).
2. Insert the disk with the label side up (see Figure 3-18), pushing it in firmly until it clicks into place.
3. Press the Setup SAVE button while holding down the FAST/SHIFT button, then press the SAVE button.

The floppy disk has now been formatted.

CAUTION

Formatting a disk destroys all information currently on the disk. Format only new disks or disks whose contents you do not want to keep.

4. Set the Memory Index number to 2, then press the Setup RECALL button. Observe that the IC-VCE characteristic curves are displayed.
5. Change the Memory Index number to 17.

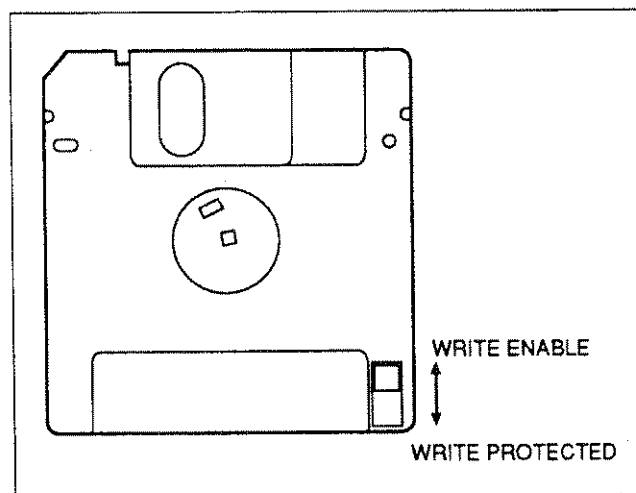

Figure 3-17. The floppy disk write-protect tab.

Measurement Modes

The 370A has three measurement modes: Repeat, Single, and Sweep.

Repeat: Repeat mode is the measurement mode automatically selected when 370A is powered up or initialized. In Repeat mode, the Collector Supply and Step Generator output are continuous.

Single: In Single mode, a set of staircase waves or pulse signal is output by the Step Generator each time the Measurement SINGLE button is pressed, while the Collector Supply is output continuously.

Sweep: In Sweep mode, a continuous series of dots is displayed when the Collector Supply is in DC mode — a situation which would normally produce only a single dot on the display. Two different Sweep mode outputs are available, Collector Supply and Step Generator, depending on the setting of the HORIZONTAL VOLTS/DIV control.

Collector Supply Sweep mode sweeps the Collector Supply output from the value selected by the VARIABLE COLLECTOR SUPPLY control to 0%, if the SWEEP button is pressed with the 370A set as follows:

VARIABLE COLLECTOR SUPPLY	Any setting except 0%
Display Mode	STORE
HORIZONTAL VOLTS/DIV	COLLECTOR range
ACQ MODE	NORM
Collector Supply POLARITY	+/- DC or +/-LEAKAGE
or	
Step Generator PULSE	SHORT or LONG (except when the Collector Supply POLARITY is set to AC)

When the 370A Collector Supply Polarity is set to + or -, it supplies a sweeping voltage to the device under test. This sweep is a 60 Hz sinewave. Driving the device with a sweep is a convenient way to observe all points along the characteristic curve; however, at low current there are limitations.

At DUT currents below a few μA , a hysteresis loop is usually seen. This separation or loop in the trace is the result of capacitance in the curve tracer, test adapter cabling, and the DUT itself. Stray capacitance in the DUT area is at least 200 pF. The curve tracer accurately displays the current through the capacitance as well as the DUT currents.

Capacitive current is proportional to the change in voltage versus the change in time. Therefore, to minimize the capacitive current "loop" display either the capacitance or the change in voltage must be minimized. The 370A provides a way to sweep the DUT much slower to minimized capacitive currents.

A **slow sweep** on the 370A Curve Tracer is generated as follows:

1. Choose either a +DC or -DC Collector Supply Polarity instead of the + or - sweep.
2. Set the DC voltage (single point display) to the desired maximum DUT voltage or current for a particular measurement.
3. Press FAST/SHIFT and SINGLE.
4. The voltage across the DUT will slowly begin decreasing until it reaches zero. Meanwhile the 370A will acquire and display all voltage measurement points.

The Step Generator output is continuous in Collector Supply Sweep mode.

Step Generator Sweep mode sweeps the Step Generator output from its peak value (step amplitude + offset) to offset value when the 370A is set as follows:

Display	HORIZONTAL VOLTS/DIV	BASE/EMITTER or STEP GEN range
Step Generator	NUMBER OF STEPS	Any setting except 0
ACQ MODE	Collector Supply POLARITY	NORM +/- DC
or		
Step Generator	PULSE	SHORT or LONG (except when the Collector Supply POLARITY is set to AC)

The Collector Supply output is continuous in Step Generator Sweep mode.

The Sweep voltage or current is displayed in the OFFSET readout area of the CRT, where the initial value displayed is the offset. The Step Generator Number of Steps is automatically set to 0 in Sweep mode.

NOTE

The sweep end voltage or current is limited to plus or minus 10 times of the STEP AMPLITUDE setting.

In Sweep mode, the Measurement mode will automatically revert to Repeat if any front-panel controls are changes except the following:

- Setup
 - SAVE
- Memory
 - Index Selection buttons
- Display
 - ENTER
 - REF
- Cursor
 - Mode selection buttons
- Position
 - CURSOR
 - DISPLAY
 - Position Control buttons (only when the Position CURSOR mode is selected)
- GPIB
 - LOCAL
 - PLOT

If Setup SAVE is pressed during the sweep, the Sweep mode settings and the initial value of the Collector Supply or Step Generator are saved in mass storage. The stored sweep can then be reactivated at any time by pressing the Setup RECALL button (with the Memory Index set to the proper location).

If the Display ENTER button is pressed during the sweep, all data captured up to that point is stored in mass storage and the sweep continues.

Collector Supply

The Collector Supply provides operating voltage for the device under test. The voltage is either a sine wave or a full-wave rectified sine wave (see Figure 3-19). This voltage is applied to the front-panel collector or base terminals.

The MAX PEAK VOLTS controls and the VARIABLE COLLECTOR SUPPLY control determine the peak voltage output of the Collector Supply, which may be varied from 0 volts to 2000 volts. The MAX PEAK VOLTS controls provide four peak voltage ranges: 16 volts, 80 volts, 400 volts and 2000 volts. The VARIABLE COLLECTOR SUPPLY allows continuous voltage variation of the peak voltage within each peak voltage range. If the peak voltage range is changed by the MAX PEAK VOLTS buttons, the Collector Supply output is automatically reset to zero.

The MAX PEAK POWER WATTS controls determine the maximum power output of the Collector Supply. Power output is controlled by placing a resistor, selected from the SERIES RESISTORS, in series with the Collector Supply output. The series resistance limits the amount of current that can be conducted by the Collector Supply. In setting the peak power output using the MAX PEAK POWER WATTS buttons, the proper series resistor is automatically selected.

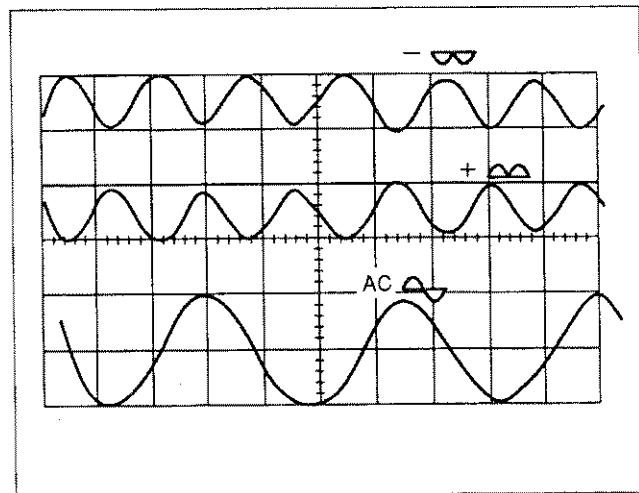

Figure 3-19. Different Collector Supply Outputs.

When the Collector Supply POLARITY is set to +LEAKAGE or -LEAKAGE, emitter current is displayed on the vertical axis. Additionally, the vertical sensitivity increases by 1000 times. (The vertical deflection factor is indicated by the VERT/DIV readout.) When POLARITY is set to +LEAKAGE or -LEAKAGE, the output of the Collector Supply is DC voltage, like that obtained when POLARITY is set to +DC or -DC, rather than a voltage sweep.

When CONFIGURATION is set to BASE COLLECTOR SUPPLY, base current is displayed on the vertical axis and the VERTICAL control provides deflection factors (unmagnified) ranging from 1 μ A/division to 2 A/division.

When the VERTICAL control is set to STEP GEN, steps indicating the Step Generator output are displayed vertically. The vertical display shows one step per division. The amplitude of each step, as shown by the PER STEP readout, determines the vertical deflection factor.

The vertical sensitivity can be increased by 10 times for any of the previously mentioned measurements by setting the MAG control to X10. The magnified vertical deflection factor is indicated by the VERT/DIV readout.

NOTE

The VERT/DIV readout does not indicate deflection factors less than 100 pA/division.

Horizontal Measurement and Deflection Factor

In the horizontal dimension, the display on the CRT measures one of the following:

1. Collector to emitter voltage (VCE).
2. Collector to base voltage (VCB).
3. Base to emitter voltage (VBE).
4. Emitter to base voltage (VEB).
5. Step Generator output.

The HORIZONTAL VOLTS/DIV control, the CONFIGURATION switches and the vertical parameter determine the horizontal parameter.

The horizontal deflection factor of the display on the CRT is controlled by the HORIZONTAL control and the MAG switch. The HORIZ/DIV readout of the CRT indicates the horizontal deflection factor.

When collector current is the vertical measurement parameter (CONFIGURATION is set to the EMITTER COMMON group except the COLLECTOR OPEN), VCE or VBE is displayed on the horizontal axis. To measure VCE, the HORIZONTAL control must be set within the COLLECTOR range that has deflection factors between 50 mV/division and 500 V/division. To measure VBE, the HORIZONTAL control must be set on a BASE/EMITTER range that has deflection factors between 50 mV/division and 5 V/division. In both cases, the horizontal deflection factors are indicated by the HORIZ/DIV readout.

When CONFIGURATION is set to the BASE COMMON group, the horizontal display measures collector to base voltage (VCB) with the HORIZONTAL control in the COLLECTOR range, or emitter to base voltage (VEB) with the HORIZONTAL control in the BASE/EMITTER range. It should be noted that VEB in this case does not indicate a measurement of the emitter-base voltage under a reverse-biased condition. It is a measurement of the forward-biased base-emitter voltage with the horizontal sensing leads reversed.

When CONFIGURATION is set to BASE COLLECTOR SUPPLY, the only significant measurement made by the horizontal display is VBE. To measure VBE, the HORIZONTAL control must be set within the COLLECTOR range.

When emitter current is being measured by the vertical display, the only significant measurements made by the horizontal display are VCE and VCB. When making these measurements, the HORIZONTAL control should be set within the COLLECTOR range.

When the HORIZONTAL control is set to STEP GEN, steps indicating the Step Generator output are displayed horizontally. The horizontal display shows one step per division and the amplitude of each step, as shown by the PER STEP readout determines the horizontal deflection factor.

The horizontal deflection factor can be increased by 10 times for any of the previously mentioned measurements by setting the MAG control to X10. The magnified horizontal deflection is indicated by the HORIZ/DIV readout.

Measurements



Table 3-2 shows the measurements that are being made vertically and horizontally by the display for the various positions of the VERTICAL control, the HORIZONTAL control and the CONFIGURATION switches. Those control position combinations not covered by the table are not considered useful.

Table 3-2
Measurements Made by the 370A Display

Switch Setting			Measured by Display	
VERTICAL	HORIZONTAL	CONFIGURATION	Vertically	Horizontally
COLLECTOR	COLLECTOR	EMITTER COMMON ¹	IC	VCE
COLLECTOR	BASE/EMITTER	EMITTER COMMON ¹	IC	VBE
COLLECTOR	STEP GEN	EMITTER COMMON ¹	IC	IB or VBE
COLLECTOR	COLLECTOR	BASE COMMON	IC	VCB
COLLECTOR	BASE/EMITTER	BASE COMMON	IC	VEB ²
COLLECTOR	STEP GEN	BASE COMMON	IC	IB or VEB ²
COLLECTOR	COLLECTOR	BASE COLLECTOR SUPPLY	IB	VBE
EMITTER	COLLECTOR	EMITTER COMMON ¹	IE	VCE
EMITTER	COLLECTOR	BASE COMMON	IB	VCE
STEP GEN	COLLECTOR	EMITTER COMMON ¹	IB or VBE	VCE
STEP GEN	BASE/EMITTER	EMITTER COMMON ¹	IB or VBE	VBE
STEP GEN	COLLECTOR	BASE COMMON	IB or VBE	VCB
STEP GEN	BASE/EMITTER	BASE COMMON	IB or VEB ²	VEB ²

¹ Except BASE COLLECTOR SUPPLY mode

² VBE indicates a measurement of forward voltage base-emitter, with the horizontal voltage sensing leads reversed.

The Collector Supply POLARITY controls determine the polarity and the type of the Collector Supply output. They also provide an initial display position on the graticule. When POLARITY is set to + , the Collector Supply output is a positive-going full-wave rectified sine wave. When POLARITY is set to - , the Collector Supply output is a negative-going full-wave rectified sine wave. The AC position of the POLARITY provides a Collector Supply output which is an unrectified sine wave. When POLARITY is set to +/- DC or +/- LEAKAGE, the Collector Supply output is a DC voltage equal to the peak voltage set by the MAX PEAK VOLTS controls and the VARIABLE COLLECTOR SUPPLY control. This DC voltage may be either positive or negative. The DC mode is very useful when the normal display is exhibiting excessive looping.

Occasionally some of the characteristic curves displayed on the CRT consist of loops rather than lines (see Figure 3-20). This effect is called looping and is most noticeable at very low or high current. Looping is usually caused by internal stray capacitance or device capacitance, or by heating of the device under test. The LOOPING COMPENSATION control provides complete compensation for non heat-related looping. It does not compensate for any added capacitance introduced by the device under test, only for internal and adapter capacitance. (The control has some effect in reducing stray capacitance in small diodes, and voltage-driven three-terminal devices.) If uncompensated looping hinders a measurement, set the Collector Supply POLARITY to +DC or -DC or use the SWEEP Measurement mode.

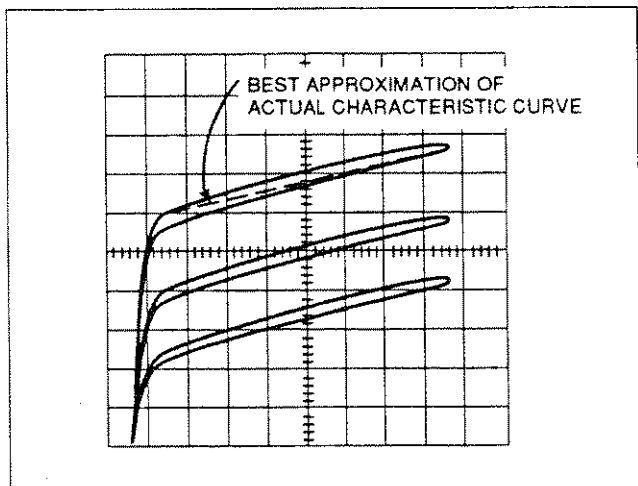

Figure 3-20. Display Looping.

Interlock System

The 370A uses an interlock system. To use the 370A, the plastic protective cover must be installed over the adapter connectors. When the protective box is in place and the lid closed, the red WARNING indicator turns on. The red WARNING indicator indicates that the Collector Supply is enabled and that a dangerous voltage may appear at the front-panel terminals.

Step Generator

The Step Generator provides current or voltage that can be applied to the base or the emitter of the device under test. The output of the Step Generator is a family of ascending steps of current or voltage (see Figure 3-21). When these steps (together with the Collector Supply output) are applied to the device under test, families of characteristic curves of the device are displayed on the CRT.

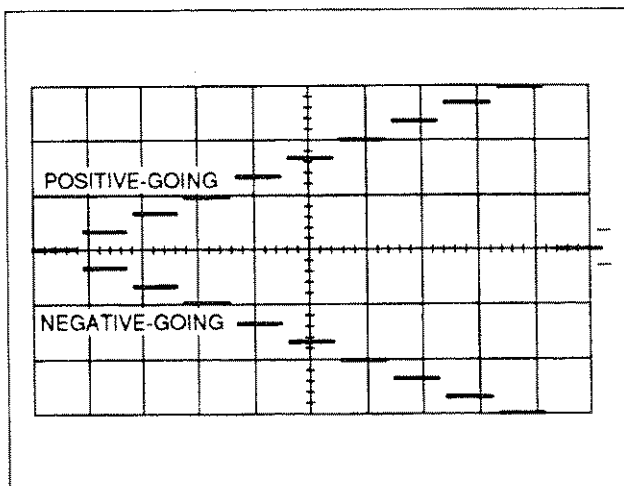

Figure 3-21. Step Generator output.

The NUMBER OF STEPS controls determine the number of steps per family and has a range of from 0 to 10 steps. VOLTAGE output or CURRENT output is selected with the Output Mode Selection buttons. The AMPLITUDE control determines the amplitude of each step. The range of step amplitudes available are from 50 nA/step to 200 mA/step for current steps and from 50 mV/step to 2 V/step for voltage steps. Pressing the STEP MULTI .1X button divides the step amplitude by 10. When voltage steps are being applied to the base of a transistor, the base current increases very rapidly with increasing base voltage. To avoid damage to the transistor when using voltage steps, current is limited by current-limiting circuit.

The OFFSET buttons allow current or voltage to be either added or subtracted from the Step Generator output. This causes the level at which the steps begin to be shifted either in the direction of the ascending steps (aiding) offset or in the opposite direction of the steps (opposing) offset. When the AID button and the OPPOSE button are pressed simultaneously, the step offset return to zero. When the AID button is pressed, current or voltage may be added to the Step Generator output. The amount of current or voltage added to the Step Generator output when the AID button is pressed is displayed at the OFFSET READOUT. Pressing the OPPOSE button allows either current or voltage to be subtracted from the Step Generator output, the amount subtracted from the Step Generator output is displayed at the OFFSET READOUT.

Opposing offset is most useful when generating voltage steps to test field effect transistors. When current steps are being generated, the maximum opposing voltage is limited to approximately 7 volts. This voltage limiting protects the base-emitter junction of a bipolar transistor from reverse breakdown.

The Step Generator POLARITY INVERT button allows the Step Generator output (both steps and offset) to be inverted. It has no effect when the CONFIGURATION setting is BASE COMMON. Use caution to avoid causing reverse current to flow between the base and emitter terminals. Voltage limiting occurs when current steps are being generated and the OPPOSE button is pressed.

When LONG or SHORT is selected by the PULSE switch, steps are generated in pulses having a duration of either 300 μ s or 80 μ s. With the aiding offset, the offset is added to the step signal as a pulse. With the opposing offset, the offset is added to the step signal as a DC. Pulsed operation is useful when testing a device at power levels that might damage the device if applied for a sustained length of time. Pulsed steps of 300 μ s duration occur when LONG is selected. When SHORT is selected, the duration of the pulsed steps is 80 μ s. When either LONG or SHORT is selected, the Collector Supply mode is automatically set to DC.

Front-Panel Terminals

The Front-Panel Terminals provide a means of connecting the Collector Supply output, the Step Generator output and the display amplifiers to the device under test.

The front-panel CONFIGURATION switches determine the state of the base, emitter, and collector terminals of the device under test. The control settings are divided in two groups: EMITTER COMMON and BASE COMMON.

In the EMITTER COMMON range, the emitter terminal is connected to ground and the CONFIGURATION controls determine the state of the base terminal. When the CONFIGURATION is set to STEP GEN, the Step Generator output is applied to the base terminal. In the OPEN (EXT) position, the base terminal is

left open. In this case measurements may be made with the base terminal left open or with an externally generated signal applied to it through the EXT BASE or EMITTER IN connector. When the CONFIGURATION is set to SHORT (EMITTER), the base terminal is shorted to the emitter. When CONFIGURATION is set to COLLECTOR SUPPLY, the Collector Supply output is applied to the base terminal and the collector terminal is left open.

In the BASE COMMON group, the base terminal is connected to ground and the CONFIGURATION controls determine the state of the emitter terminal. With the CONFIGURATION set to STEP GEN, the Step Generator output is inverted and applied to the emitter terminal. When the control is set to OPEN (EXT), the emitter terminal is left open. In this case, measurements may be made with the emitter terminal left open or with an externally generated signal applied through the EXT BASE or EMITTER IN connector.

Devices to be tested are connected to the 370A through adapter connectors. These connectors allow two devices to be set up at the same time for comparison testing. The LEFT-RIGHT-STANDBY control determines which device is under test. The 370A test adapters may be plugged into the adapter connectors. These adapters provide sockets into which devices with various lead arrangements may be placed for testing. Refer to the ACCESSORIES portion of Section 1 for test adapter information.





The connectors labeled "SENSE" Allow Kelvin sensing of voltages measured under high current conditions. Kelvin sensing means that current is supplied to a device under test through one set of contacts and the voltage is measured through another set of contacts. This method of sensing voltage eliminates errors in voltage measurements due to contact resistance.

The STEP GEN OUT connector allows the Step Generator output to be used externally. The EXT BASE or EMITTER IN connector allows application of an externally generated signal to either the base or the emitter of the device under test. The external signal is applied to whichever terminal is chosen by the CONFIGURATION switches. The AUX SUPPLY OUT connector supplies the auxiliary voltage to external.

Polarities of the Collector Supply and Step Generator Output

Table 3-3 shows the polarities of the Collector Supply and the Step Generator output for various settings of Collector Supply POLARITY and CONFIGURATION.

Table 3-3
Polarities of the Collector Supply and Step Generator Output

Switches		Polarities	
Collector Supply POLARITY	CONFIGURATION	Collector Supply	Step Generator
- 	EMITTER COMMON	Negative going	Negative going*
- 	BASE COMMON	Negative going	Positive going
+ 	EMITTER COMMON	Positive going	Positive going*
+ 	BASE COMMON	Positive going	Negative going
AC	EMITTER COMMON	Positive and Negative going	Positive going*
AC	BASE COMMON	Positive and Negative going	Negative going

* May be inverted by pressing the POLARITY INVERT button.

Digital Storage and Mass Storage System

The digital storage mode displays acquired characteristic curves with a bright, flicker-free trace. This mode digitally stores characteristic curves in the internal memory, converts the curves to analog-signals, and displays them on the CRT. The mode is activated by pressing STORE. The NON STORE/STORE/VIEW INTENSITY control adjusts the store intensity. The resolution of acquisition is 100 points/division in both axis.

Acquisition Modes

The 370A has two ACQUISITION modes (STORE MODE), AVERAGE and ENVELOPE. In AVERAGE mode, acquired curves are averaged and displayed on the CRT after calculation. A running count of the acquisition is displayed on the CRT.

After the acquisition count exceeds 16, the 370A continues the averaging but acquisition count stops incrementing.

The average method for subjected data in a displayed curve is expressed by an equation that provides a pseudo moving-average calculation.

$$Dna = (Dn-1 \times (N - 1) + Dn) / N, \text{ where:}$$

Dna = averaged one data in curve,
Dn-1= previous data,
Dn = currently acquired data,
N = average number

Averaging is useful for reducing uncorrelated noise in signals and improves its signal-to-noise ratio.

In ENVELOPE mode, either HORIZONTAL ENVELOPE or VERTICAL ENVELOPE is selected by the ACQ MODE switches. The 370A repetitively acquires the curves and displays the resultant waveform envelope. The waveform is compared to the maximum and minimum values of the same data point from previous sweeps. If the data point is either greater than the previous maximum value or less than the previous

minimum value, the previous data point value is replaced by the new value. If the data point falls between the currently held maximum or minimum value for that point, it is discarded.

Enveloping is useful for revealing subtle variations in signals and allows the 370A to be left unattended for a long period of time while monitoring signals for time and amplitude variations such as thermal drift.

Mass Storage

The 370A has a mass storage system consists of non-volatile IC memory and 3.5-inch floppy disk drive. This system can store characteristic curve data, text, front-panel settings, and other information in mass storage. Up to 64 characteristic curves and 64 sets of front-panel settings can be stored in a floppy disk, and 16 curves and 16 sets of settings in non-volatile IC memory. Data stored in mass storage can be transferred to external devices via the GPIB interface. See Section 4 for more information about GPIB functions.

Saving in Store and View Mode

In the Store or View mode, pressing the ENTER button stores the characteristic curve, the displayed setting and readout values, and any displayed text in mass storage. Information stored in mass storage can be displayed by pressing the VIEW button. The intensity of a characteristic curve displayed from mass storage is controlled with the NON STORE/STORE/VIEW INTENSITY knob.

While in Sweep mode, pressing the ENTER button stores all captured data in mass storage. The stored data can be displayed by pressing the VIEW button.

Using the REF Curve

When the REF button is pressed in either the Store or View modes, the STORE or VIEW curve being displayed at that time is stored in the REF memory and is displayed along with the STORE or VIEW curve as the REF (reference) curve. This REF curve remains on the CRT when the display mode is switched between STORE and VIEW. Thus, the REF function can be used to compare the current STORE or VIEW curve with the STORE curve displayed when the REF button was pressed, or to compare one VIEW curve with the current STORE curve or another VIEW curve. The intensity of a REF curve is controlled with the REF INTENSITY knob. When the SAVE button is pressed, the REF curve is saved in the mass storage as a part of setup. The REF curve is removed from the CRT either by pressing the REF button once again or by selecting the Non Store mode.

Saving and Recalling Front-Panel Setting

Front-panel setting information and user-entered text is saved in mass storage by pressing the SAVE button. Pressing the RECALL button resets front-panel settings according to the stored information.

NOTE

When the position of the OUTPUTS breaker is not the same as when the front-panel settings now to be recalled were originally stored, the message "OUTPUT UNMATCH" is displayed at the bottom left of the CRT. Switch the OUTPUTS breaker, and press the RECALL button once again.

Pressing the SAVE button in Sweep mode saves the Sweep mode setting in mass storage. The initial value of the Collector Supply or Step Generator output is also stored.

Handling a Floppy Disk

3.5-inch floppy disks are easy to handle and store, but the following precautions should be taken to protect the disk and the integrity of the data stored within it.

Do not expose the floppy disks to strong magnetic fields, and do not place them near strongly ferromagnetic material that can be easily magnetized. If these cautions are not observed, data may be destroyed, or errors may occur.

Do not expose floppy disks to direct sunlight or high temperatures for long periods of time. Storage of floppy disks in extremely cold locations or subjecting them to high humidity should also be avoided.

It is extremely important to place the floppy disks back in their cases for long-term storage. It is also very important to attach the index label at the correct position.

Formatting A Disk

CAUTION

Formatting a disk destroys all data stored on the disk. Make sure you no longer need this data before you format the disk.

A new floppy disk must first be formatted before it can be used. Insert the disk into the disk drive and press the SAVE/FORMAT button while holding down the FAST/SHIFT button. The message "PRESS SAVE" will appear at the bottom left of the CRT for about 5 seconds. Press the SAVE button again while this message is displayed to initiate disk formatting. If the SAVE button is not pressed, the formatting function is aborted, the message "FORMAT ABORTED" is displayed, and the 370A return to the normal operating mode.

NOTE

When the attempt is made to format a disk with the write protect tab set at the write protect position, the message "WRITE PROTECT" appears at the bottom of the CRT, and the formatting function is canceled.

While disk formatting is in progress, "FORMAT BUSY" is displayed at the bottom left of the CRT and the number of the track currently being formatted is shown in Memory Index Display. When the track number reaches 79 and formatted is completed, the message "FORMAT END" is displayed at the bottom left of the CRT, and the 370A returns to the normal operating mode.

NOTE

During disk formatting, the 370A will not accept any interrupts.

A disk formatted on the 370A MS-DOS is file-compatible with IBM PC computers. A "370A" volume label is written and a "370A" sub-directory is made on all disks formatted on the 370A.

Directory Display

If the RECALL button is pressed while holding down the FAST/SHIFT button, the 370A goes into the directory display mode, and the directory containing the files stored in mass storage containing front-panel setting data and characteristic curve data are listed on the CRT. (See Figure 3-22.)

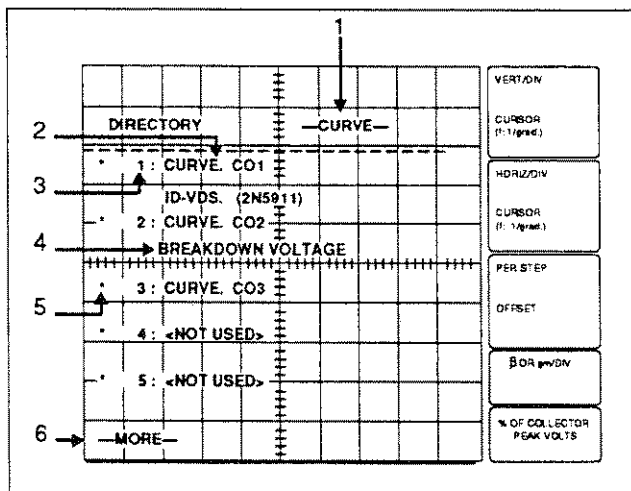

Figure 3-22. Directory Display

1. Data Type (CURVE or SETUP)

The directory displayed is for files containing characteristic curve data (CURVE) or for files containing front-panel setting data (SETUP).

2. Filename (CURVE.CXX or SETUP.SXX)

The names of stored files containing characteristic curve data or front-panel setting data are shown. For filename specifications refer to the section below on "Data Files".

3. Index Number (1 to 80)

This indicates the memory location at which the files are stored. Memory location 1 to 16 are reserved for the non-volatile IC memory, and memory location 17 to 80 for the floppy disk.

4. Text

This indicates the text stored together with front-panel settings or characteristic curve.

5. Asterisk

An asterisk before the index number means that the file is stored in non-volatile IC memory.

6. Screenfull Prompt (MORE or END)

This indicates whether the directory being displayed has reached the last page or not.

In the directory display mode, the function of MEMORY buttons (up, down) changes to incrementing or decrementing directory page numbers. In memory index display, the page number of the directory being displayed is shown. If the up MEMORY button is pressed, the page number is incremented, and if the down MEMORY button is pressed, the page number is decremented. If these buttons are pressed simultaneously, the page number is reset to 1. If there is no data stored in the memory location indicated by the index number, a "<NOT USED>" is displayed in place of the file name. If an attempt is made to display the directory for index numbers in the range 17 to 80 when there is no disk in the disk drive, a "<FD NOT READY>" is displayed in place of the file name. If any button or switch other than the MEMORY, SAVE, RECALL, and FAST/SHIFT button is operated, the 370A automatically returns to the normal operating mode.

Data Files

Characteristic curve data and front-panel setting data are stored in mass storage in files with names in the following format when the ENTER or SAVE button is pressed.

Characteristic curve data file-name
CURVE.Cnn
Front-panel setting data file-name
SETUP.Snn

where

nn are identifier numbers in the range 01 to 80 indicating the memory location in mass storage where the file is stored.

Non Store Mode

The 370A also has a Non Store display mode. In this mode the characteristic curve data is not stored in main memory but displayed directly on the screen. This mode can be used to observe rapid variations in the waveform.

The intensity of the characteristic curve displayed in the Non Store mode is controlled by the NON STORE/STORE/VIEW INTENSITY knob.

Cursors

Cursors allow easy, precise measurements. The 370A has three types of cursors: Window, Dot, and f Line. Only the Window cursor is available in Non Store mode.

The window cursor is displayed as a rectangle with a bright dot in either the lower left or upper right corner, as selected by the CURSOR mode selection buttons. The current and voltage values at the position of the bright dot are displayed in the CURSOR readout area. The Position control buttons move the bright cursor dot and change the size of the window.

Unlike the Dot cursor and f Line cursor, the Window cursor can be used in Non Store as well as Store mode, and can be displayed at any point on the screen. It is typically used to check for the characteristics of a device under test to be within a certain range. It can also be used to measure the hFE on the curve of the collector current vs. collector-emitter voltage characteristics of a transistor. When the vertical side of the cursor is positioned between two adjacent curves, the hFE value is displayed in the β OR gm/DIV readout area.

The dot cursor is a high-intensity spot displayed on the characteristic curve. The current and voltage values at the cursor position are given in the readout area.

The f Line cursor is a straight line that passes through the dot cursor position at a slope that can be varied by the four Position control buttons.

When COLLECTOR is displayed on the horizontal axis, the CURSOR (f:1/grad) readout indicates the resistance, while the CURSOR (f:intercept) readout indicates the voltage value at which the f line cursor intercepts the horizontal axis.

When BASE/EMITTER is displayed on the horizontal axis, the CURSOR (f:1/grad) readout indicates the forward transfer admittance, while the CURSOR (f:intercept) readout indicates the voltage value at which the f line cursor intercepts the horizontal axis.

The f line cursor is useful for measuring the on-state resistance of a device and for measuring the forward transfer admittance of FETs.

Text Editing

Text, consisting of letters, numbers, and symbols, can be displayed at the top of the 370A CRT graticule. The text may be used to label characteristic curves with identification information or to note measurement conditions. The text is stored in mass storage along with the characteristic curve or setup information.

Entering Text Edit Mode

To enter the text edit mode, press the Position CURSOR button while holding down the FAST/SHIFT button. (The FAST/SHIFT button changes the function of the CURSOR button to TEXT, as noted in blue below the button.) The "TEXT EDIT MODE" message is displayed at the bottom of the graticule for about 5 seconds and the Text Edit cursor is displayed at the top, indicating that the 370A is ready for text entry.

Entering and Editing Text

The character to be entered is selected with the Position Control buttons (up, down) and the position at which it is displayed is selected with the Position Control buttons (left, right). Only the functions of these four buttons change in the edit mode; the functions of other buttons and knobs remain the same.

A maximum of 24 text characters can be entered. Available text characters are:

space, A, B, ... Z, space, m, u, n, p, ., 0, 1, ..., 9, -, /, *, (,), =

Erasing Text and Exiting the Text Editor Without Changes

While in Text Edit mode, pressing the FAST/SHIFT button erases the character at which the edit cursor is displayed and the cursor moves to the next position on the left. Simultaneously pressing the left and right buttons erases the text entered up to that point and the edit cursor moves to the left side of the text area. Pressing the NON STORE, STORE, VIEW, RECALL, or Position DISPLAY button in Text Edit mode causes the 370A to exit Text Edit mode, erase the text data entered so far, and display the "TEXT CANCELED" message.

Saving Edited Text

When the text is satisfactorily edited, press the Position CURSOR button. The Text Edit ends and the 370A returns to normal operation.

Text may be saved in the following ways:

To save the edited text along with the characteristic curve in mass storage, press the ENTER button.

To save the text along with front-panel setup information, press the SAVE button.

Text is saved automatically when Text Edit mode is exited if the text was entered from View mode.

Displaying a Directory of Stored Text



The text stored in mass storage can be displayed on the CRT as a directory table by pressing the RECALL button while holding down the FAST/SHIFT button. The FAST/SHIFT button changes the function of the RECALL button to DIRECTORY, as labeled in blue below the button. (See Directory Display in the Digital Storage and Mass Storage System portion of this section for details.)

MEASURING EXAMPLES

This part of the Operating Instructions describes the use of the 370A to measure some basic parameters of bipolar transistors, field effect transistors, silicon controlled rectifiers, signal and rectifier diodes, Zener diodes. For each of the devices discussed, this section includes tables of 370A control settings required to make an accurate measurement without damaging the device under test. Below each table is a block diagram showing the connections of the collector supply, the step generator and the display amplifiers to the device under test, and a picture of a typical characteristic for the semiconductor type being discussed. Also included is a list of common measurements that may be made on the given devices with the 370A and a brief set of instructions on how to make each of these measurements.

This section has been written with the assumption that you are familiar with the operation of the 370A as described at the beginning of this section. It is also assumed that you are familiar with the parameters under discussion.

BIPOLAR TRANSISTORS

Control	Required Setting
HORIZONTAL	COLLECTOR
COLLECTOR SUPPLY POLARITY	For the Common-Emitter Family, +  or -  depending on the transistor type.
MAX PEAK POWER WATTS	Less than maximum power rating of device.
STEP GENERATOR OUTPUT	CURRENT
PULSE	Set to LONG or SHORT when using high base current
CONFIGURATION	EMITTER COMMON BASE STEPGEN for common-emitter family BASE COMMON EMITTER STEP GEN for common-base family
STEP GENERATOR	AID pressed if more than 10 steps are desired

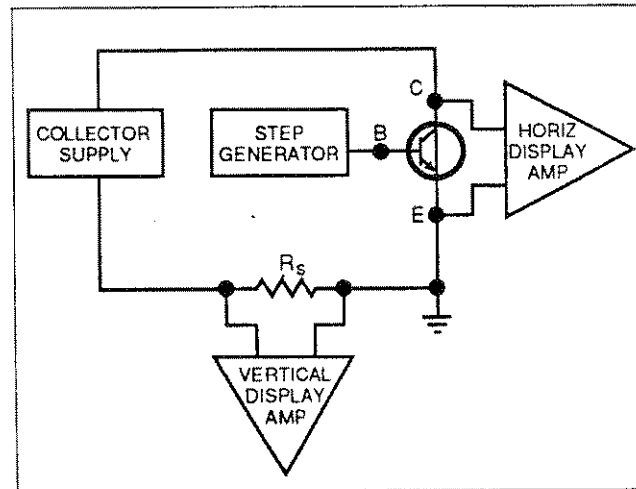

Figure 3-23. Bipolar Transistor Common-emitter Configuration.

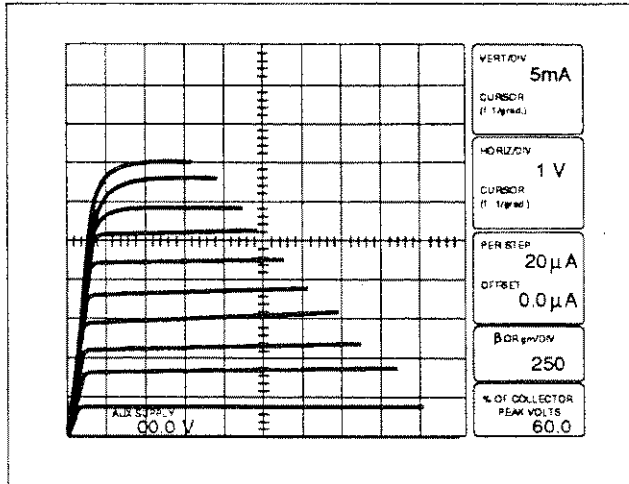

Figure 3-24. Bipolar Transistor Family of Curves.

Some Common Measurements

β (Static) The static forward current transfer ratio (emitter grounded), h_{FE} , is I_C/I_B . h_{FE} can be measured with the Dot cursor. The h_{FE} of the device under test is displayed in the β OR gm/DIV readout.

β (Small Signal) The small-signal short-circuit forward current transfer ratio (emitter grounded), h_{FE} , is $\Delta I_C/\Delta I_B$. To determine h_{FE} at various points in a family of curves, multiply the vertical separation of two adjacent curves by the β OR gm/DIV readout or use the Window cursor (refer to Step Generator in the FIRST TIME OPERATION portion of this section).

VCE (Sat) Saturation current and voltage is measured by expanding the display of the saturation region of the device by decreasing the horizontal deflection factor with the HORIZONTAL control or the MAG switch. Saturation current can be adjusted to the desired operating point with the STEP AMPLITUDE switch.

IC vs VBE Base-emitter voltage can be measured by setting the HORIZONTAL control to the BASE/EMITTER range.

ICEO and BVCEO Collector-emitter leakage current and collector-emitter breakdown voltage (base open) are measured by setting the CONFIGURATION to BASE OPEN (EXT). For small leakage currents set the Collector Supply POLARITY to LEAKAGE. To measure breakdown voltage, increase both the horizontal deflection factor and the collector supply voltage.

ICES and BVCES Collector-emitter leakage current and collector-emitter breakdown voltage (base shorted to emitter) are measured the same as ICEO and BVCEO, except that the CONFIGURATION is set to BASE SHORT.

ICER and BVCEr Collector-emitter leakage current and collector-emitter breakdown voltage (with a specified resistance between the base terminal and the emitter terminal) are measured the same as ICEO and BVCEO except that a specified resistance is connected between the base terminal and the emitter terminal.

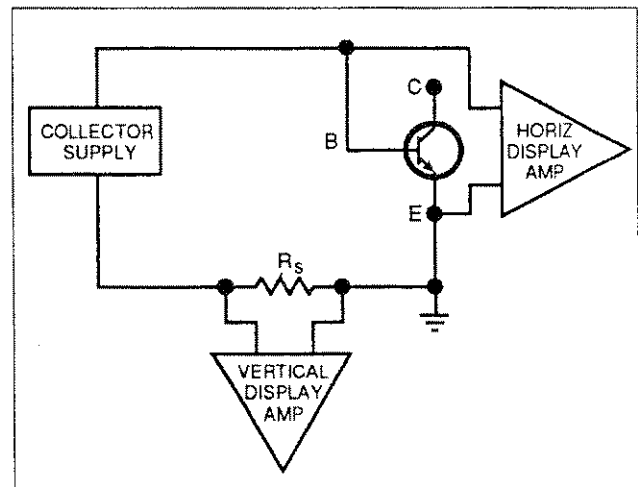

Figure 3-25. Bipolar Transistor Open-Collector Configuration.

IEBO and BVEBO Emitter-base leakage current and emitter-base breakdown voltage (collector open) is measured the same as ICEO and BVCEO, except that the CONFIGURATION is set to COLLECTOR OPEN and the Collector Supply POLARITY is set to inverted polarity.

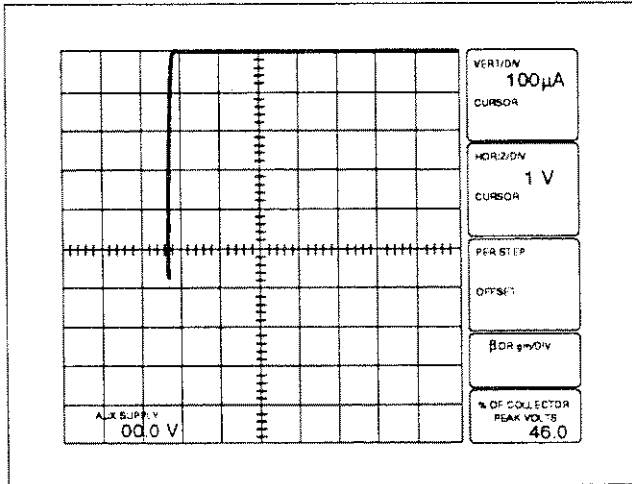

Figure 3-26. Bipolar Transistor Curve.

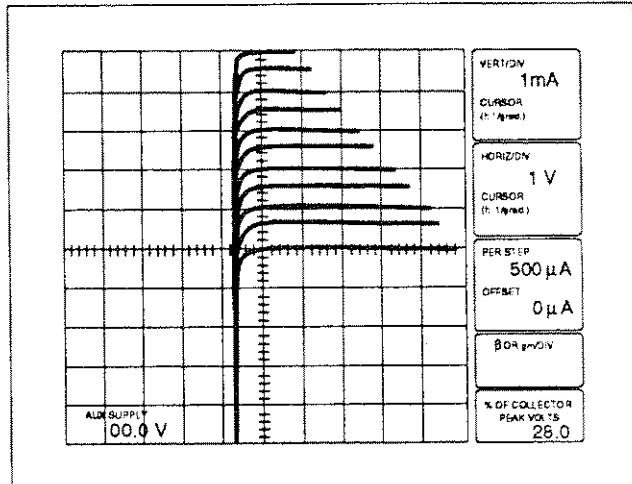

Figure 3-28. Bipolar Transistor Family of Curves.

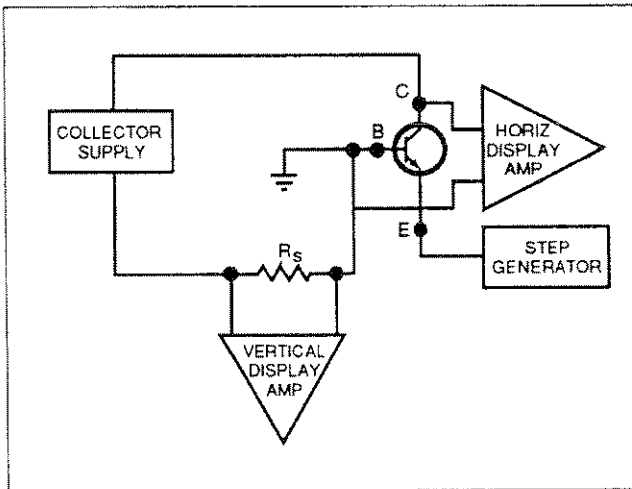



Figure 3-27. Bipolar Transistor Common-base Configuration.

α (Small Signal) The small-signal short-circuit forward-current transfer ratio (base grounded), h_{fb} , can be measured from the common-base family display but is determined most easily by calculating it from the equation $h_{fb} = \beta / (1 + \beta)$.

ICBO and BVCBO Collector-base leakage current and collector-base breakdown voltage (emitter open) is measured the same as $ICEO$ and BV_{CEO} , except that the CONFIGURATION is set to EMITTER OPEN (EXT).

FIELD EFFECT TRANSISTORS

Control	Required Setting	
HORIZONTAL	COLLECTOR	
COLLECTOR SUPPLY POLARITY	+  for N-channel device; -  for P-channel device	
MAX PEAK POWER WATTS	Less than Maximum power rating of the device	
STEP GENERATOR OUTPUT	VOLTS	
PULSE	OFF	
CONFIGURATION	EMITTER COMM BASE STEP GEN	
STEP GENERATOR POLARITY INVERT	Enhancement	Depletion
	Not inverted	Inverted
STEP GENERATOR OFFSET with POLARITY INVERT button pressed	Enhancement	Depletion
	OPPOSE	ZERO or AID

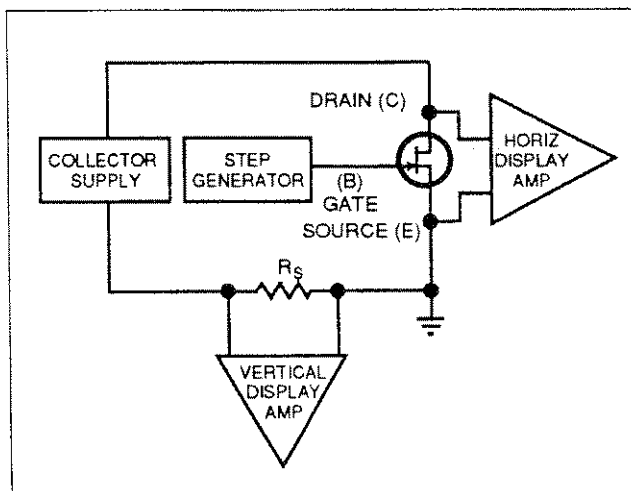

Figure 3-29. Common-source FET Configuration Diagram.

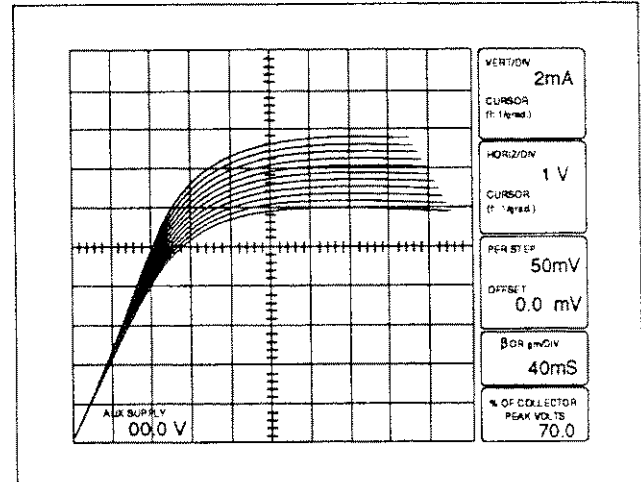

Figure 3-30. Common-source FET Configuration Family of Curves.

Some Common Measurements

gm (Static) The static transconductance (source grounded) is I_D/V_{GS} . I_D/V_{GS} can be measured with the Dot cursor. The I_D/V_{GS} of the device under test is displayed in the beta OR gm/DIV readout.

gm (Small Signal) The small-signal transconductance (source grounded) formula is $\Delta I_D/\Delta V_{GS}$. To determine gm at various points in a family of curves, multiply the vertical separation of two adjacent curves by the β OR gm/DIV readout or use the f Line or Window cursor (refer to Collector Supply and Step Generator in the FIRST TIME OPERATION portion of this section).

IDSS Drain-source current with zero V_{GS} is measured from the common-source family, with the CONFIGURATION set to BASE SHORT (EMITTER). It should be measured above the knee of the curve.

Pinch-Off Voltage Pinch-off voltage (V_p) is measured by increasing the depletion voltage with the STEP GENERATOR OFFSET control and the STEP AMPLITUDE control until the specified pinch-off current is reached by the zero step.

BVGSS Gate-source breakdown voltage is measured with the drain shorted to the source; place the gate lead of the device in the drain terminal of the test socket, and the source lead in the gate terminal and the drain lead in the source terminal. Set the CONFIGURATION to BASE SHORT (EMITTER) and reverse the collector supply polarity. This measurement should not be made on an insulated-gate device.

SILICON CONTROLLED RECTIFIERS (SCRs)

Control	Required Setting
HORIZONTAL	COLLECTOR
MAX PEAK POWER WATTS	Less than device maximum power rating
COLLECTOR SUPPLY POLARITY	+ 
PULSE	Set to LONG or SHORT when using high gate voltage or current
CONFIGURATION	EMITTER COMMON BASE STEP GEN

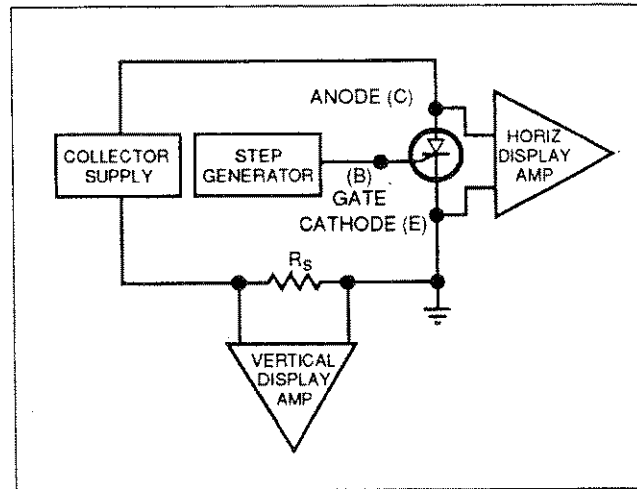

Figure 3-31. Silicon-controlled Rectifier Configuration Diagram.

SIGNAL DIODES AND RECTIFYING DIODES

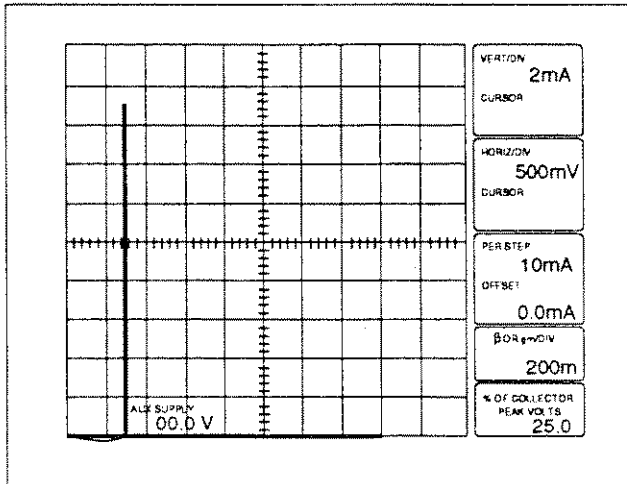

Figure 3-32. Silicon-controlled Rectifier Curve.

Control	Required Setting
HORIZONTAL	COLLECTOR
MAX PEAK POWER WATTS	Less than device maximum power rating
COLLECTOR SUPPLY POLARITY	+
CONFIGURATION	EMITTER COMMON BASE SHORT

Some Common Measurements

Turn-on The gate voltage or current at which the device turns on is measured by applying a specified voltage between the anode and cathode terminals, using the VARIABLE COLLECTOR SUPPLY control and applying current or voltage steps in small increments to the gate with the STEP AMPLITUDE control.

Forward Blocking Voltage To measure the forward blocking voltage, set the CONFIGURATION to BASE OPEN (or SHORT, depending on the specification) and turn the VARIABLE COLLECTOR SUPPLY control clockwise until the device switches to its low impedance state. The voltage at which switching occurs is the forward blocking voltage.

Holding Current Holding current is measured in the same manner as forward blocking voltage. Holding current is the minimum current conducted by the device, while operating in its low impedance state, without turning off.

Reverse Blocking Voltage The reverse blocking voltage is measured the same way as the forward blocking voltage, except that the Collector Supply POLARITY is set to -

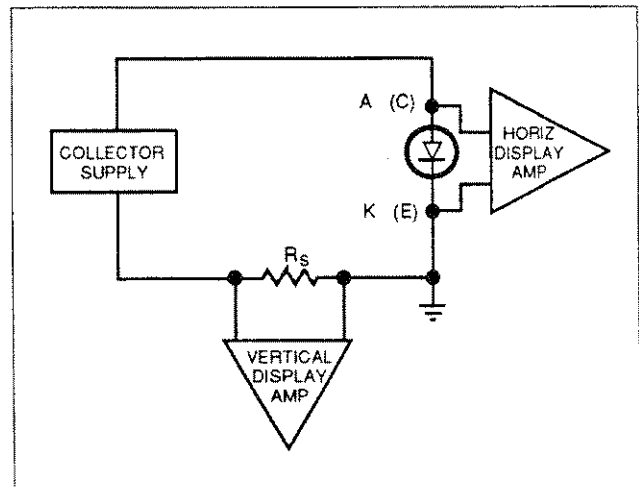

Figure 3-33. Diode Configuration Diagram.

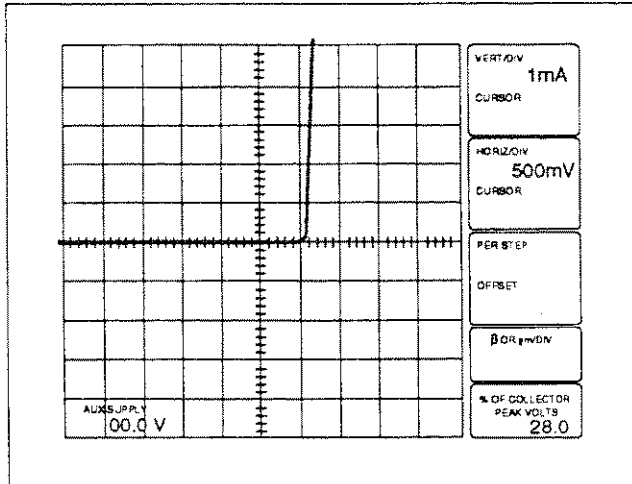

Figure 3-34. Diode Curve.

Some Common Measurements

IF and VF To measure forward current and voltage, insert the cathode of the diode in the emitter terminal of the test socket and the anode of the diode in the collector terminal. Apply voltage to the device with the VARIABLE COLLECTOR SUPPLY control.

IR and VR Current and voltage in the reverse direction are measured in the same manner as in the forward direction except that the Collector Supply POLARITY is set to \ominus . To measure small amounts of reverse current, set the Collector Supply POLARITY to \ominus LEAKAGE.

ZENER DIODES

Control	Required Setting
HORIZONTAL	COLLECTOR
MAX PEAK POWER WATTS	Less than device maximum power rating
COLLECTOR SUPPLY POLARITY	\ominus
CONFIGURATION	EMITTER COMMON BASE SHORT

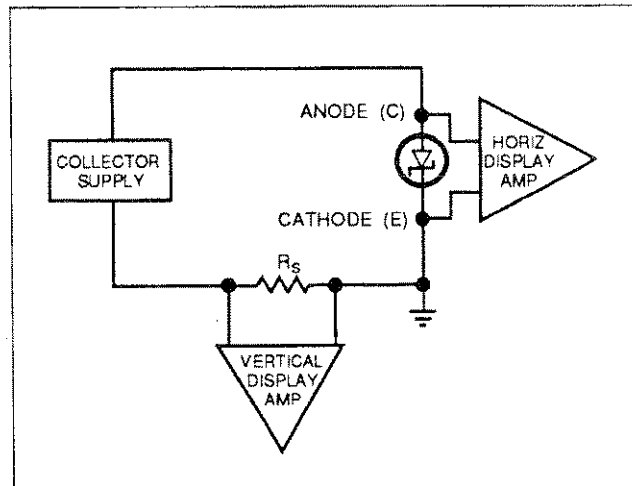

Figure 3-35. Zener Diode Configuration Diagram.

Some Common Measurements

VZ and IR To measure Zener voltage or reverse current, insert the diode cathode in the emitter terminal of the test socket and the anode of the diode in the collector terminal. Apply voltage to the device with the VARIABLE COLLECTOR SUPPLY control. For measurements of small amounts of reverse current, set the POLARITY to LEAKAGE.

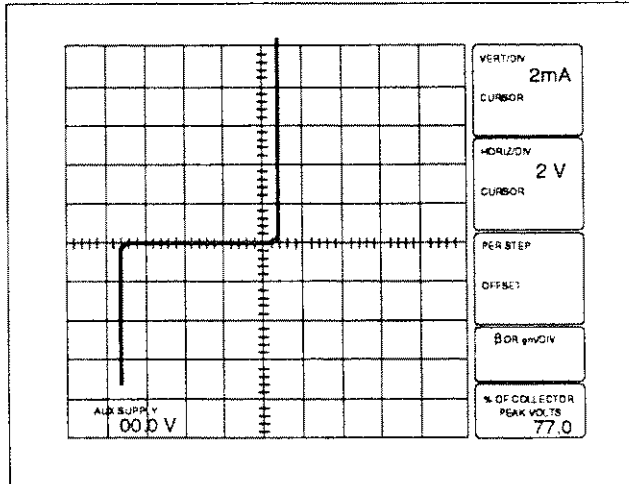
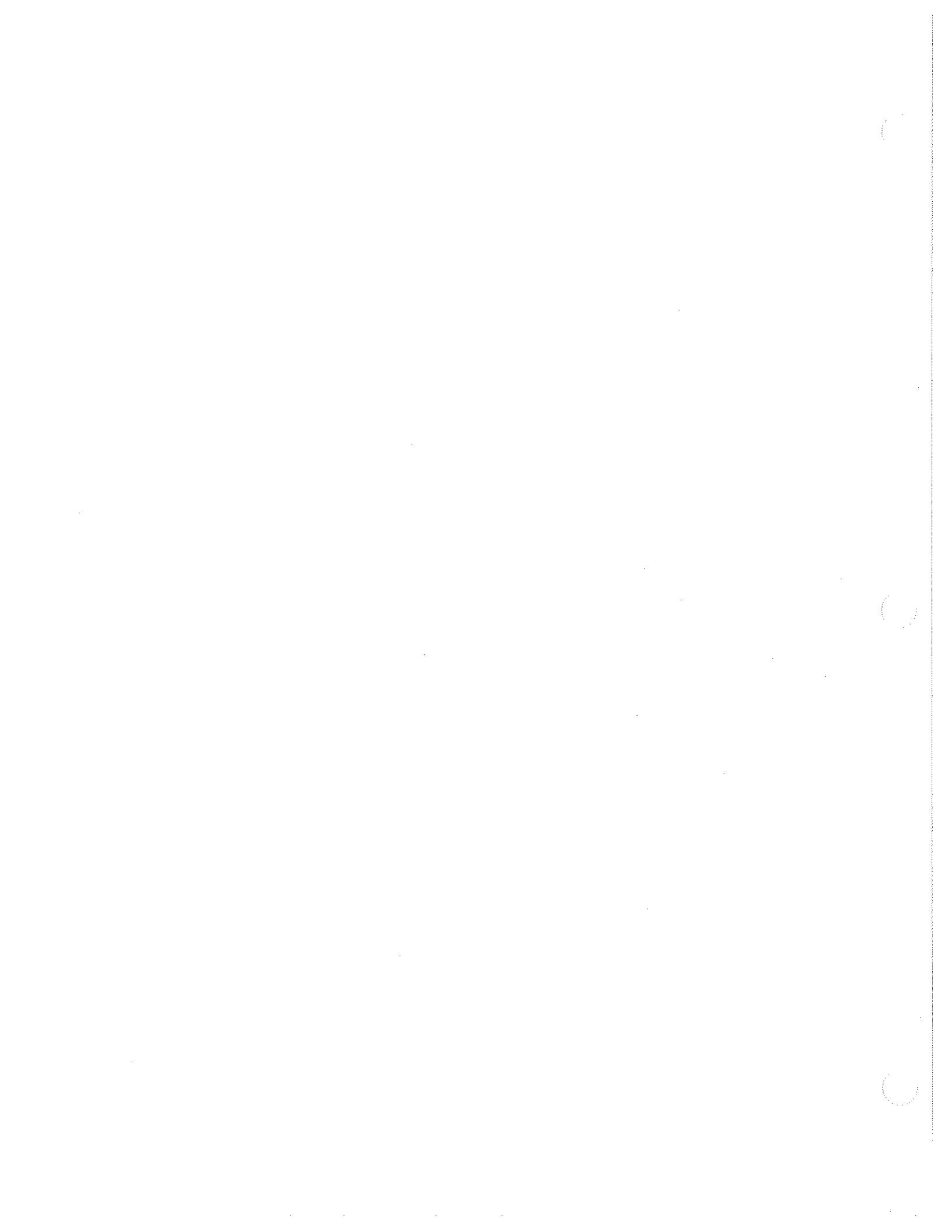

Figure 3-36. Zener Diode Curve.

IF and VF Current and voltage in the forward direction are measured in the same manner as in the reverse direction, except that the Collector Supply POLARITY is set to + Δ . For a display of currents and voltages in both directions, set the POLARITY to AC.



Section 4

GPIB

4 GPIB

■ REVIEW

The General Purpose Interface Bus, or GPIB, is a standardized, digital interface for interconnecting up to 15 self-contained instruments, controllers, and other devices. The instruments may be units such as the 370A Curve Tracer, signal generators, digital multimeters, or digital oscilloscopes. The ANSI¹/IEEE² 488.1-198x standard defines two aspects of the interface: the hardware and a basic communication protocol.

Hardware

The hardware consists of a set of interface circuits in each device, along with standard 24-conductor cabling for interconnecting the device in a system. Sixteen of 24 wires are used for signaling: eight for addresses or data, three for handshaking during data transfers, and five for interface management. Most data is transferred as a series of eight-bit bytes over the eight data lines.

Communication Protocol

The basic communication protocol specifies a set of pre-defined interface messages for system organization and housekeeping, but only indicates the basic requirements for communicating other information such as setup commands and measurement results. The protocol does not define the meaning or format of the measurement results, which are termed device-dependent messages.

¹ANSI - American National Standards Institute

²IEEE - Institute of Electric and Electronic Engineers, Inc.

Meaningful messages for each instrument are specified by the instrument manufacturer and are usually defined in the instrument manual. Tektronix has standardized on a higher level protocol for all its GPIB instruments, called Tektronix Codes and Formats.

A typical GPIB system will include a controller and one or more instruments, such as the 370A Curve Tracer. Some instruments are talk-only or listen-only devices while others can both talk and listen. The 370A does both. Linking a controller to the 370A, and possibly other instruments, provides operation in four major task areas:

- Program development
- System control
- Data processing
- Display and storage

These four task areas are discussed in the following paragraphs.

Program development

Program development includes writing, editing, and debugging the programs needed to control the instruments in the system.

System Control

While running a program, the controller assigns tasks to instruments in the system, coordinates communication, handles error conditions, and monitors the system's progress.

This instrument control task can be further divided into five functions:

- Addressing instruments
- Sending commands
- Transmitting and receiving data
- Handling interrupts
- Monitoring device status

Each of these system control functions are explained below.

Addressing Instruments

The controller selects an instrument by addressing it. Each instrument on a bus is assigned a unique primary address in the range 0 through 30. The controller uses this address to set an instrument to talk or listen.

Sending Data and Commands

Device-dependent messages carry commands and data from the controller to the 370A and return instrument status information and measurement data. The ATN line (pin 11 of the GPIB) is asserted while interface messages are sent to distinguish them from device-dependent messages. (see Figure 4-1).

Interface messages are commands that control interface functions. The IEEE 488 standard specifies interface message so that they are the same for all devices.

There are two kinds of interface messages: uni-line and multi-line, where "line" refers to the 16 signal lines within the bus. Multi-line messages can be further subdivided into universal commands, addresses, and addressed commands. Figure 4-2 shows how the different types of GPIB messages are related and indicates the standard three-letter symbols assigned to them.

Multi-line interface messages are sent by placing a byte on the eight data lines of the GPIB and asserting the ATN line. Universal commands affect all devices on the bus while addresses and addressed commands affect only the addressed instruments.

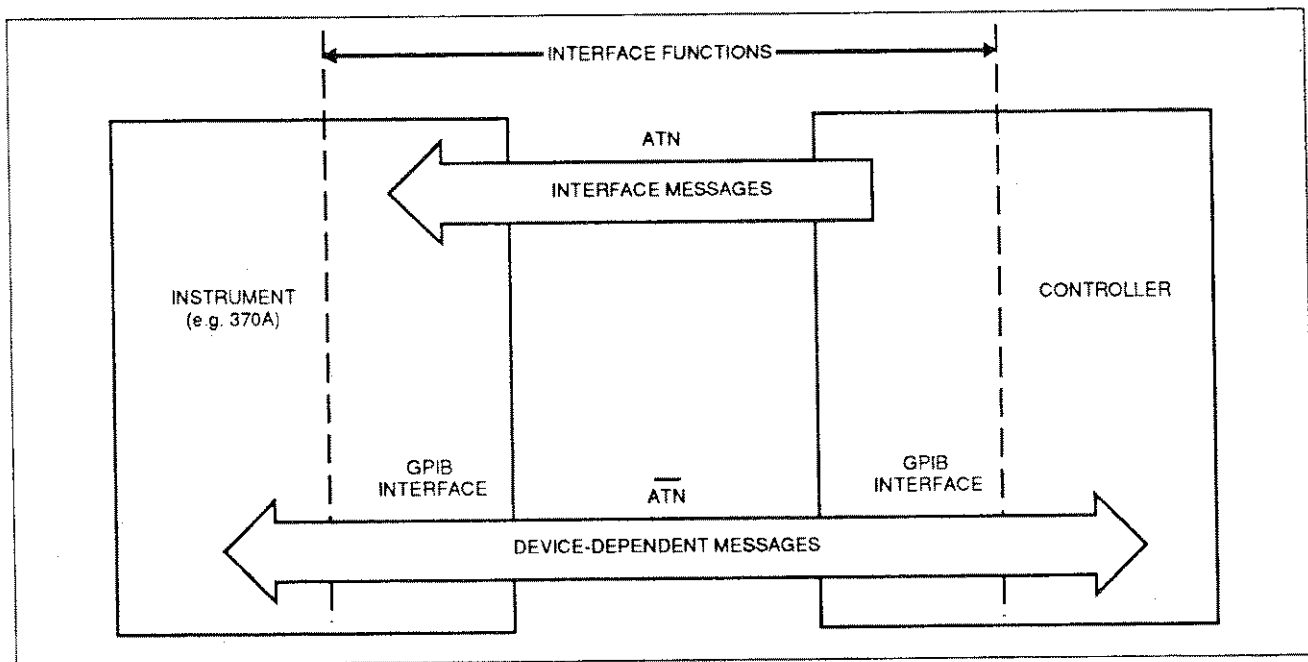

Figure 4-1. GPIB messages.

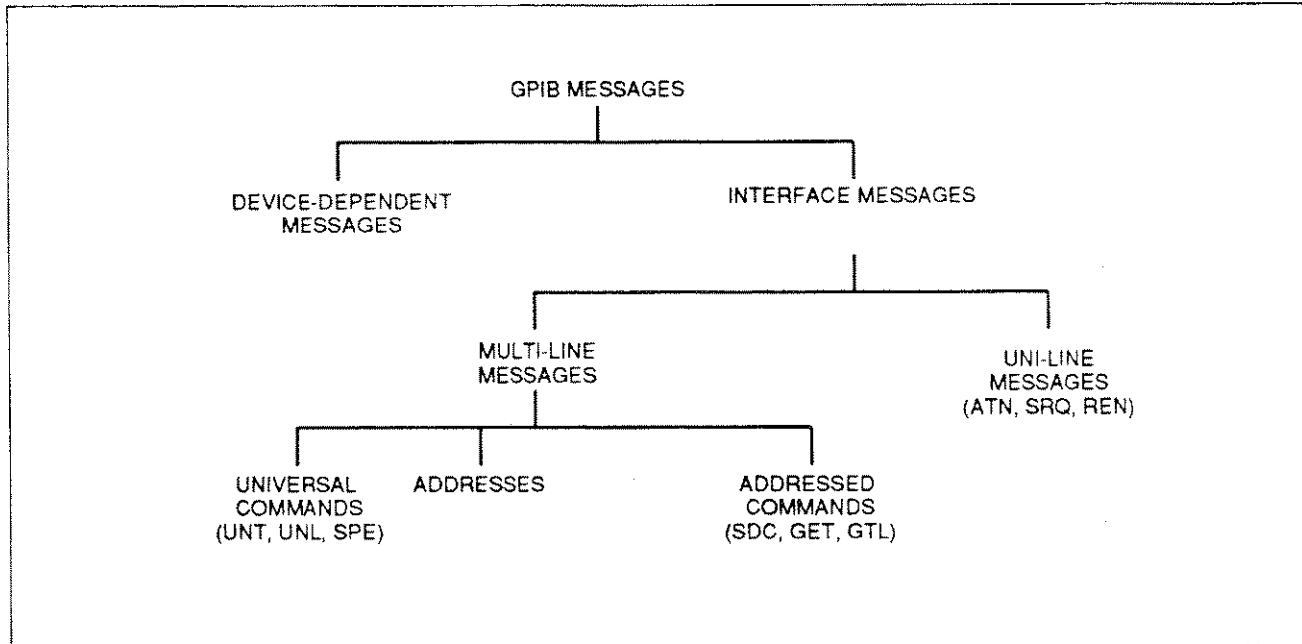

Figure 4-2. GPIB message types.

Uni-line interface messages are sent by asserting one of the five individual interface signal lines of the GPIB:

- SRQ (service request)
- ATN (attention)
- IFC (interface clear)
- REN (remote enable)
- END (EOI, end or identify)

Device-dependent messages consist of commands or data that control instrument function and communicate instrument status, as well as data from measurements and other information. As noted before, the content and format of these messages has been addressed with Tektronix Codes and Formats. All of these message types are significant for the 370A.

Transmitting and Receiving Data

Most instruments talk (send data) or listen (receive data) to the system controller. The 370A does both. In fact the 370A sends and receives two classes of data: instrument setups and measurement results. There are various ways of coding such data. The 370A, in keeping with Tek Codes and Formats, uses English key-words for setup and status data and a combination of similar key-words and a form of binary-coded numbers for measurement data.

Handling Interrupts

The 370A and other devices in the system can generate interrupts to inform the controller of conditions warranting some sort of attention, such as an error condition or the completion of an operation. The controller polls the devices on the bus to find the source of the interrupt, reads its status, and takes appropriate action.

Data Processing

Still another major task of a GPIB system controller is processing the data acquired from instruments. Examples might be extracting key parameters from a family of curves and deciding whether some pass-fail criterion has been exceeded.

Display and Storage

Once data has been sent to the controller it can be stored or displayed, as well as processed. The controller console screen is one place data may be displayed.

■ INTERFACE CAPABILITIES

IEEE Standard 488 defines a variety of possible interface capabilities for differing needs among various controllers and instruments.

Table 4-1 summarizes the capabilities realized in the 370A. The abbreviations are detailed in the IEEE standard.

Table 4-1
 GPIB Interface Specifications

Function	Subset	Note
Source Handshake	SH1	Complete capability
Acceptor Handshake	AH1	Complete capability
Talker	T6	Basic Talker, Serial Poll, Talk Only, Unaddress if MLA
Listener	L4	Basic Listener, Unaddress if MTA
Service Request	SR1	Complete capability
Remote/Local	RL2	Complete capability
Parallel Poll	PP0	No capability
Device Clear	DC1	Complete capability
Device Trigger	DT0	No capability
Controller	C0	No capability

Interface Messages

The following explains how the curve tracer reacts to standard interface messages. Abbreviations are from IEEE Standard 488. As noted before, a uni-line message is sent over a dedicated line and a multi-line message is sent using the eight data lines while the ATN line is asserted. In the following descriptions, uni-line messages are described as having the appropriate line asserted. Multi-line messages are described with their respective ASCII code and decimal value for the eight-bit byte expressed on the eight data lines.

Due to the set of interface functions required for the 370A, not all of the possible interface messages would be meaningful. The 370A does not respond to the following:

GET Group execute trigger
 PPC Parallel poll configure
 PPU Parallel poll unconfigure
 TCT Take control

It does respond to or use the following interface messages, as described.

My Listen and My Talk Address (MLA and MTA)

The 370A's address is established by setting the address select switches on the rear panel. When the 370A receives its own address along with either of these commands, it responds by entering the appropriate state: ready to talk or ready to listen.

Attention (ATN)

With the ATN line asserted, data on the eight data lines is interpreted as an address or interface message. With most controller programming languages, operation of the ATN line is transparent to the user.

Unlisten (UNL) and Untalk (UNT)

When the Unlisten (UNL) message (ASCII "?", decimal 63) is received, the 370A listen function is placed in an idle (unaddressed) state. In the idle state, the 370A will not accept messages over the GPIB. The Talk function is placed in an idle state when the curve tracer receives the Untalk (UNT) message (ASCII "_", decimal 95). In this state the 370A cannot transmit data via the GPIB.

Interface Clear (IFC)

When the interface Clear (IFC) line is asserted, both the Talk and Listen functions are placed in an idle state. This produces the same effect as receiving both the Untalk and Unlisten commands. It resets the interface only, clearing the input and output buffer, and does not affect any instrument functions. This can be used to restart communication with the 370A.

Device Clear (DCL)

The Device Clear (DCL) message (ASCII "Control T", decimal 20) reinitializes communication between the 370A and the controller. In response to Device Clear, the 370A clears any input and output messages as well as any unexecuted control settings. Any errors and events waiting to be reported, except power-up, are also cleared. If the SRQ line has been asserted for any reason other than power-up, it becomes unasserted when DCL is received.

Selected Device Clear (SDC)

The Selected Device Clear (SDC) message (ASCII "Control D", decimal 4) performs the same function as DCL. However, only instruments that have been listen-addressed respond to SDC.

Go To Local (GTL)

The Go TO Local (GTL) message (ASCII "Control A", decimal 1) returns the 370A to the front panel and turns off the front-panel REMOTE indicator, just as the front-panel LOCAL button does.

Remote Enable (REN)

When the Remote Enable (REN) line is asserted and the instrument receives its listen address (MLA), the 370A is placed in its Remote State (REMS) and the front-panel REMOTE indicator is turned on.

Service Request (SRQ)

The Service Request (SRQ) line is set by the 370A each time it has a change in status to report to the controller.

Serial Poll Enable and Disable (SPE and SPD)

The Serial Poll Enable (SPE) message (ASCII Control X, decimal 24) causes the 370A to transmit its serial-poll status byte when it is talk addressed. The Serial Poll Disable (SPD) message (ASCII Control Y, decimal 25) switches the 370A back to normal operation.

End or Identify (END or EOI)

The 370A or controller sets End Or Identify (EOI) simultaneously with the last byte of the command or data if LF (line feed)/EOI is currently selected as the message terminator. If LF alone is selected, the message terminator is LF accompanied by EOI and followed by a CR (carriage return).

Local Lockout (LLO)

When a Local Lockout (LLO) message (ASCII "Control 0", decimal 17) is received, the 370A enters the Lockout state.

NOTE

The 370A has no front-panel Lockout indicator to indicate when Lockout is set. Once set, all subsequent inputs from front-panel keys with corresponding remote commands will be ignored.

Device-Dependent Messages

Device-dependent messages for the 370A are in three categories: commands and queries, setup data, and measurement data.

Commands and Queries

Commands are sent to the 370A to initiate some action or change its settings. Some commands may be as short as three characters. Other more complex commands may be much longer.

A notable subcategory of commands is that of query commands or queries. The 370A responds to a query by sending another device-dependent message back to the controller. This response communicates the appropriate instrument status, settings, or measurement data. These messages may also vary from a few characters to many characters in length.

Setup Data

Since most front-panel settings are programmable, a series of commands can set-up the 370A for a particular measurement. In fact, a group of individual settings or an entire front-panel setup can be strung together and sent as a single message.

Queries can be used, in turn, to send individual settings or complete front-panel setups back to the controller. This means a setting can be made manually and then stored using the bus controller, providing an alternative to storing the setting in the mass storage of the 370A.

Measurement Data

Usually the most significant data available from the 370A are sets of characteristic curves from devices being tested. For any given measurement this data is packaged in two parts: a preamble and a curve. Preambles and curves can be read from the 370A into the controller either separately or combined. Later they can be loaded back into the 370A for further use.

The preamble contains the information needed for interpreting, scaling, and labeling the numeric information in the curve. This preamble is coded in ASCII characters and is readable by the operator without interpretation by the controller.

The curve is a series of binary-coded numbers expressing the X-Y coordinates of the 1024 digitized points representing the displayed curves. These binary-coded numbers are interpreted by the controller.

Two other types of data that can be read out of the 370A are: the coordinates of a cursor located on the curves, and the text shown in the text-display area of the screen.

■ SETUP

The first steps in putting the 370A to work in a system are:

- Setting the bus address
- Choosing the message terminator
- Connecting the GPIB cable
- Powering up

These steps are discussed in the following paragraphs.

Configuration Switch Settings

The 370A has a configuration switch bank on the rear panel which is used to set the bus address and message terminator (see Figure 4-3).

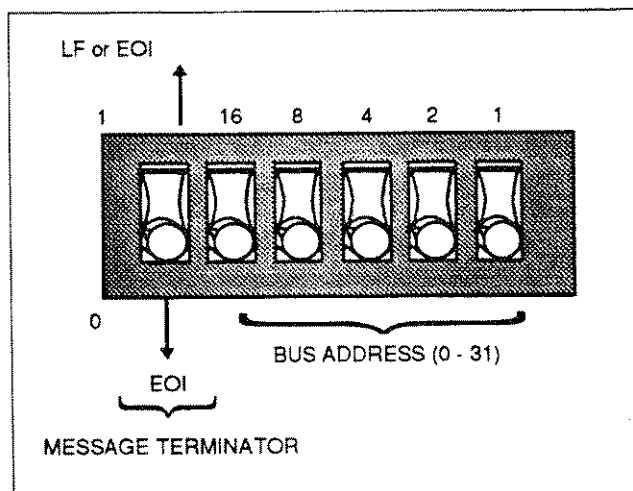

Figure 4-3. Rear-panel configuration switch.

Setting the Bus Address

Each instrument connected to the bus must have a unique address. This address is used by the controller to direct the flow of data to and from that specific device.

When choosing a bus address for the instrument, remember:

- The address of the 370A must be unique on the bus.

- Some controllers reserve an address for themselves.

- Selecting an address of 31 logically removes the 370A from the bus; it does not respond to any GPIB address, but remains both unlistened and untalked.

- The 370A uses primary addressing only. Sending a secondary address will have no effect.

- The address setting can be verified or changed by examining or setting the address switches located on the rear of the 370A (see Figure 4-3).

The address can also be verified by simultaneously pressing the front-panel FAST/SHIFT and LOCAL keys. The message terminator and bus address appear in the error message area of the 370A.

Choosing the Message Terminator

The terminator is used to indicate the end of a message transfer. The two most common terminators are the EOI (end or identify) signal line and the LF (line feed) character.

If EOI is selected, the 370A will assert the EOI line simultaneously with the last data byte when sending a message, and will recognize the EOI line as the terminator when receiving a message. If LF is selected, a CR (carriage return) and LF (line feed) are sent following the last data byte. The EOI line is asserted simultaneously with the LF character.

When receiving a message, the 370A will terminate the message upon receiving either the LF character or the assertion of the EOI line.

The best way to determine which terminator to use is to look at the specifications for the system controller and use the same terminator. For the Tektronix 4041 and the HP 200/300 Series, this would be the EOI terminator.

The terminator can be set with the terminator switch on the rear-panel configuration-switch bank (see Figure 4-3).

Reading in the Switch Settings

The switch settings are read by the 370A's processor only at power-up or when the message terminator and bus address are displayed on the CRT. Therefore, when switches are changed while the power is on, simultaneously press the FAST/SHIFT and LOCAL keys to make the switch change effective.

Connecting the GPIB Cable

Attach the 370A to the GPIB with a standard GPIB cable. A GPIB system may be connected in two general configurations: star or line. While the star configuration is recommended, configurations can be mixed as long as the total cable length does not exceed 20 meters and the instruments are distributed on the bus according to a few basic rules (see Figure 4-4).

First, no more than 15 total devices, including the controller, can be included on a single bus. In addition, to maintain proper electrical characteristics, one device load must be connected for every two meters of cable. Generally, each instrument represents one device load on the bus. The 370A represents one device load.

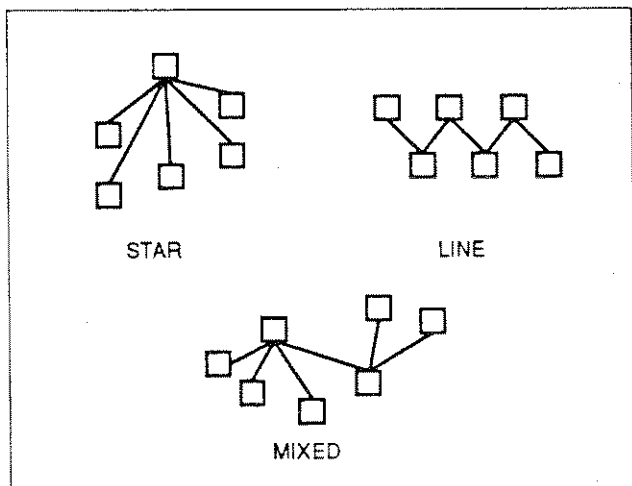

Figure 4-4. Bus configurations

Powering Up

With the 370A connected by GPIB cable to the system and the address and message terminator has been set, the system is ready to power up. Powering up the 370A as part of a GPIB system involves special considerations, as detailed in the following paragraphs.

Remember, when powering up a system with several GPIB instruments on the bus, at least half of the instruments must be powered up before the controller is brought "on-line".

Self Test

To turn on the 370A, press the front-panel POWER switch. The 370A performs a self-test at power-up and initializes itself to a pre-defined state, after which it's ready to make measurements. For details of the power-up test, see Appendix A, Diagnostic Routines and Messages. The power-up default state for the 370A is the same as for the INIt command described under Table 4-11 System Commands and Queries in the Command list portion of this section.

Power-Up SRQ

When the power-up tests have been completed, the 370A asserts the GPIB line called SRQ. In the interface, the status byte is set to 65.

CONTROLLING THE 370A OVER THE BUS

As explained in the following discussion, a controller can:

- Send commands to the 370A
- Send queries and receive responses
- Control 370A settings
- Store and transfer 370A data
- Move waveform data from the 370A
- Load waveform data to the 370A
- Transfer cursor and readout data to and from the 370A

Sending Commands to the 370A

Most GPIB system controllers and their languages provide high level statements for sending device-dependent messages, such as commands, to any system instrument, including the 370A.

These high-level statements usually consist of three parts:

1. A key word (PRINT, OUTPUT, WRITE, etc) which causes the action (sending the message over the bus) to occur.
2. An address or logical unit number which directs the message to a specific instrument.
3. The device-dependent message which is the actual command, query, or data to be recognized by the instrument. (Most controllers delimit the device-dependent message with double quotes.)

The following examples show command strings for two controllers and a representative language for each. The first is an IBM PC with a Tektronix GURU card (or National Instruments model PC2 or PC2A card) running BASICA. The second is a Hewlett Packard 200 or 300 Series Scientific Computer running Series 200 or 300 BASIC.

In these examples, the 370A device-dependent command WINDOW (abbreviated as WIN) is used to set the window cursor to midscreen. In the second and third examples, the GPIB address of the 370A is assumed to be "8".

IBM PC: (The address is assigned elsewhere in the code.)

```
220 WRT$="WIN 250,250,750,750" 'Create
    Command string.
230 CALL IBWRT(DSO%,WRT$) 'Send
    command.
```

Hewlett Packard 200/300 Series:

```
220 OUTPUT 708; "WIN 250,250,750,750"
    ,END
```

A useful addressing variation assigns the 370A address to a variable and uses that variable in place of the specific numeric address. In the following examples, the address is set to "6". This method works for both the example controllers when running BASIC and allows the destination of several commands to be altered by changing only the value of one variable: this is the scheme used in the IBM PC with the GURU card, running BASICA.

Hewlett Packard 200/300 Series:

```
720 DEVICE=706
730 OUTPUT DEVICE;"WIN 250,250,750,750"
    ,END
```

or

```
720 ASSIGN @DEVICE TO 706
730 OUTPUT @DEVICE;"WIN 250,250,750,
    750" ,END
```

The examples in Table 4-2 shown how the syntax of several different controllers can vary.

Table 4-2
Controller Output Syntax

Controller Language	Output Command
IBM PC with BASICA	WRT\$="string" CALL IBWRT(DEV%,WRT\$)
HP 200/300 SERIES BASIC	OUTPUT 710;"string",END
HP 9825/200-SERIES HPL	wrt 710,"string"

Sending Queries and Receiving Responses

Commands with a question mark (?) are query commands which solicit information from the 370A. After the controller sends a query command, it must acquire the resulting response from the 370A. Examples using the HOR? query command follow.

IBM PC:

```
150 WRT$="HOR?"
160 CALL IBWRT(DSO%,WRT$) 'Send query.
170 RD$=SPACE$(100)
180 CALL IBRD(DSO%,RD$) 'Input
    response.
```

Hewlett Packard 200/300 Series:

```
150 DIM SET$(100)
160 OUTPUT 710;"HOR?",END
170 ENTER 710;SET$
```

In these examples, a string is dimensioned to 100 characters in order to store the incoming information. The controller sends HOR? over the bus to the 370A located at primary address 10. The controller then assigns the instrument at address 10 to be a talker and inputs the characters into the target variable, SET\$. The following shows a possible response, which is a 18 character string. The variable, SET\$, now contains this string of characters showing the current status of the horizontal controls:

```
HORIZ COLLECT:1E-1
```

Most commands have a corresponding query command. See the 370A GPIB COMMANDS portion of this section for examples. Table 4-3 shows how query responses are input from a variety of controllers.

Table 4-3
Controller Input Syntax

Controller Language	Input Command
IBM PC with BASICACALL	IBRD\$(DSO%,RD\$)
HP 200/300 SERIES BASIC	INPUT 710;S\$,END
HP 9825/200-SERIES HPL	red 710,S\$

Instrument Setup Over the Bus

One popular use of the GPIB with the 370A is to store front-panel settings for later recall. These stored settings are then used to set up the curve tracer for repeating specific tests. This is accomplished by using a query command to acquire from the 370A an ASCII string representing the front-panel setup. This string is saved by the controller. Later, this same setup can be restored by sending the stored string back over the bus to the 370A.

Storing Settings for the 370A

When a setting is transferred, it must first be moved to the front panel. From there it may be moved to the controller or to mass storage. Figure 4-5 shows the transfer routes and the commands.

To bring the 370A front-panel setting data into the controller, use the SET? query and put the response into a string variable or variables that can hold up to 500 characters. From there it can be stored on any medium available to the controller, such as magnetic tape or disk.

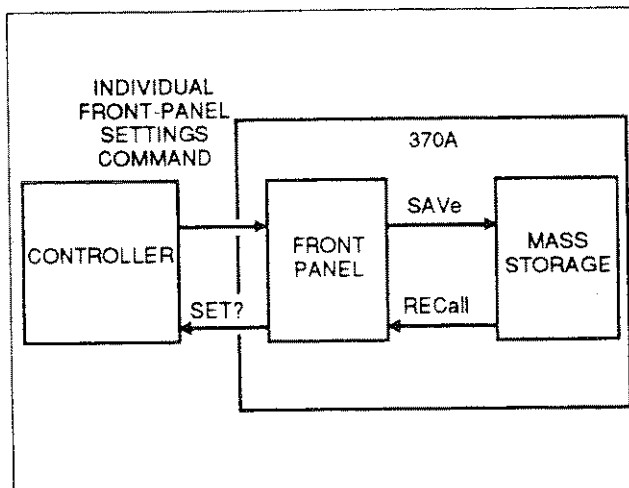

Figure 4-5. Transfer of settings.

IBM PC:

(BASICA is limited to a 255 character maximum string so the IBRD command will have to be executed twice to take in the full possible extent of the settings string.)

```

400 WRT$="SET?" ' Set up query command
      string.
410 RD $=SPACE$(250) ' Assign space for
      a 250 character response string.
420 RD2$=SPACE$(250) 'Assign space for
      a 250 character response string.
430 CALL IBURT(DSO%,WRT$) 'Send query.
440 CALL IBRD(DSO$,RD$) 'Input response
      for first 250 characters.
450 CALL IBRD(DSO%,RD2$) 'Input
      response for remaining characters.
    
```

Hewlett Packard 200/300 Series:

```

400 DIM SET$(500)
410 OUTPUT 710;"SET?",END
420 ENTER 710;SET$
    
```

A settings string that is stored by the controller can, of course, be modified. Use the appropriate string manipulation commands in the controller language to search for, modify, or replace parts of the string. Be sure that the resulting string meets the syntax requirements of the 21 individual commands making up the whole and that they are in the proper sequence. See the 370A GPIB COMMANDS portion of this section for details.

To save the current front-panel setting in the mass storage, choose an appropriate setting storage location number of 1 through 70, then send the command `SAVe <number>`, where `<number>` identifies the setting storage location.

Loading Setting into the 370A

To reverse the above process for settings stored by the controller, simply take the appropriate settings string from wherever it has been stored and send the string back to the 370A. There is no need for any preface or other command since the settings string is made up of the very commands that are needed. When it is necessary to break the setting string, as in `BASICA`, the break should occur where a semicolon would normally appear and that semicolon should be dropped.

The following examples use the settings strings that were saved in the preceding set of examples.

IBM PC:

```
700 CALL IBWRT(DEVX,SETA$)
710 CALL IBWRT(DEVX,SETB$)
```

Hewlett Packard 200/300 Series:

```
700 OUTPUT 710;SET$,END
```

If the settings were stored in the mass storage, it's necessary to know which of the 70 memory locations was used. Then send the command `RECall <NRI>`, where the number, `<NRI>`, identifies memory location.

While these procedures can change settings quickly and without error, the operator may have to make a few manual settings (e.g., the `OUTPUTS` breaker and the position of the protective cover). One way to remind the operator what needs to be done is to send a message using the text display area of the 370A screen. Send an appropriate message of up to 24 characters using the `TEXT <string>` command.

Data Storage and Transfer

Once the 370A has been set up to make a desired measurement, the next step in realizing the advantages of digital storage is to acquire and store the data with the 370A. This in turn allows you to plot it, if you have an attached plotter, or copy it into the controller or mass storage. From the controller you can store it on other media, compare it with other data, calculate with it, or display it. See Figure NO TAG for the possible routes for data transfers.

In most cases, acquiring data with the 370A involves two parts, both done automatically by the instrument. The first is to code the necessary scale factors and other parameters into a series of words and numbers. The words are English but are standardized so they can also be read by a computer. This part of the data is called the preamble.

The second part of data acquisition is to digitize and code the displayed curves. This converts the curves to a series of binary numbers representing the horizontal and vertical locations of a sequence of points along the curves. This part of the data is called the curve. Together with the preamble it fully describes the displayed curve.

Acquiring Data Within the 370A

To acquire data, set the display function to Store mode. The command to do this over the bus is `DISplay STOrE`. At this point the current set of parameters are recorded and the curves being shown are digitized. They can now be copied over the bus to the controller or to an attached plotter.

Data Structure

The preamble and curve are each a string of eight-bit bytes. The preamble is a string of ASCII letters, numerals, and punctuation. Each character is represented by one byte. The major part of a curve is a sequence of binary-coded numbers, which is prefixed by a 25 character ASCII string identifying the curve.

The curve data string represents the 370A display, where each data point in the display is described as a 10-bit horizontal and 10-bit vertical position. The horizontal and vertical positions are each coded as a pair of bytes in the data string. Thus, there are four bytes for each data point. Since a display can have from 1 to 1024 data points, the curve data can include from 4 to 4096 bytes. In addition, there are two bytes at the start of the string for a byte count and one byte at the end for a checksum value, for a maximum of 4099 bytes.

The numbers are coded in two's-complement binary format. The low-order eight bits are stored in the second byte while the two high-order bits are stored in the low-order positions of the first byte. The sign bit fills the remaining bits in the high-order byte.

Moving Waveform Data to the Controller

Waveform data is transferred from the 370A to the controller in two parts, the preamble and the curve data. As explained in the following discussion, these two parts can be transferred together or separately.

Transferring the Preamble

To receive a waveform preamble from the 370A, send the command query WFMpre?. The response will be a string containing 17 parameters, each shown as a label and value pair. See the Table 4-10 in the Command List portion of this section for details. Follow the command query with an instruction to the controller to input the response, allowing for a string about 410 characters long.

Hewlett Packard 200/300 Series:

```
300 DIM PREAM$(410)
310 OUTPUT 718;"WFM?";END
320 ENTER 718;PREAM$
```

Transferring the Curve

When a waveform is transferred to the controller, it must first be displayed. When a waveform is transferred from the controller it must go directly to the mass storage. The routes and commands are shown in Figure 4-6.

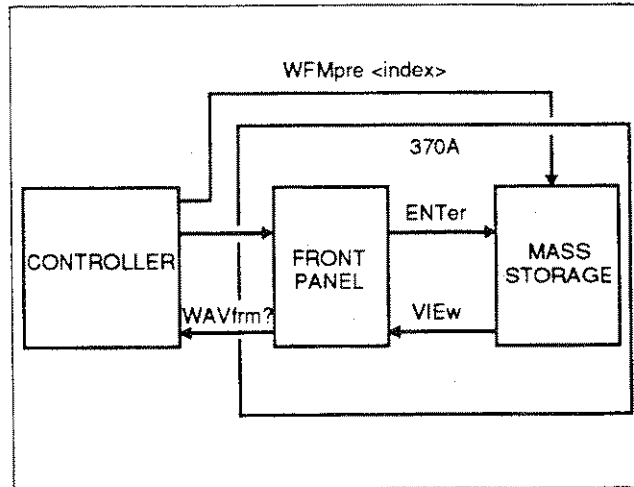

Figure 4-6. Transfer of waveforms.

To copy displayed data in Store or View mode to the controller, first send a WFMpre? query to transfer the preamble. Then send a CURve? query to transfer the curve.

To copy the data from mass storage to the controller, first send a DISplay VIEW:<index> command to display the curve stored at the index location. Then send a WFMpre? query to transfer the preamble from the display. Last, send a CURve? query to transfer the curve from that location. Another command, WAVfrm?, combines the functions of WFMpre? and CURve? and return the whole display, preamble plus curve, with an ASCII semicolon between them.

For the curve data, in general, provisions will have to be made for a string length of about 4125 bytes. The response will be a short (25 bytes or characters) ASCII string identifying the curve, two bytes giving the number (in binary) of data points to follow, the 4096 bytes representing the actual curve data, and a checksum (one binary byte).

Transferring the Waveform to Mass Storage

Another possibility for storing data under control of the bus is to put the waveform into a mass-storage waveform-storage location. Use the ENTER <NR1> command, where the number, <NR1>, is the storage location index.

Loading Data from the Controller

Moving display data from the controller to the 370A waveform-storage location of 17 through 80 requires that an unlocked floppy disk be in place.

NOTE

Data transferred from the 370A in Store mode cannot be reloaded to the 370A.

Loading the Preamble

The command WFMpre <string>, where <string> is a waveform preamble, will load that preamble into the 370A. The preamble will be stored in the mass-storage location indicated by the WFID INDEX portion of the string (see WFMpre in the Command List portion of this section for details).

Loading the Curve

When sending display data to the 370A, the target is the mass storage location set by the preceding preamble transfer.

To send a curve from the controller to the 370A, use the command CURve <string>, where <string> consists of a short ASCII string (CURVID) followed by a string of binary bytes. See WFMpre in the Command List portion of this section for details.

Transferring Other Types of Data

Although waveforms are the principal data developed with the 370A, there are two other types of data: cursor readout and text.

Transferring the Cursor Readout

The point at which a dot cursor is located on the display can be expressed in terms of display units. The data is requested with the READout? command and the response is the READOUT followed by a pair of numbers giving the cursor location in terms of physical units: horizontal location in volts and vertical location in amperes. With the f Line cursor activated, the response to the READout? query gives the cursor 1/gradient in ohms abbreviated as "OHM", and the horizontal intercept in volts. The window cursor can be used similarly but the readout value depends on the last manual setting as to whether it comes from the upper-right or lower-left corner of the rectangular window.

Transferring Text

Although it's not data in the same sense, information in the text display area can be read over the bus with the TEXT? query command. Text can also be replaced in the display with the TEXT command, as described in the Command List portion of this section.

Summary of Data Transfers

There are several kinds of data and, as demonstrated in the previous paragraphs, they differ in content and format. There are a number of ways to move these various kinds of data from place to place, as shown in Figure 4-7.

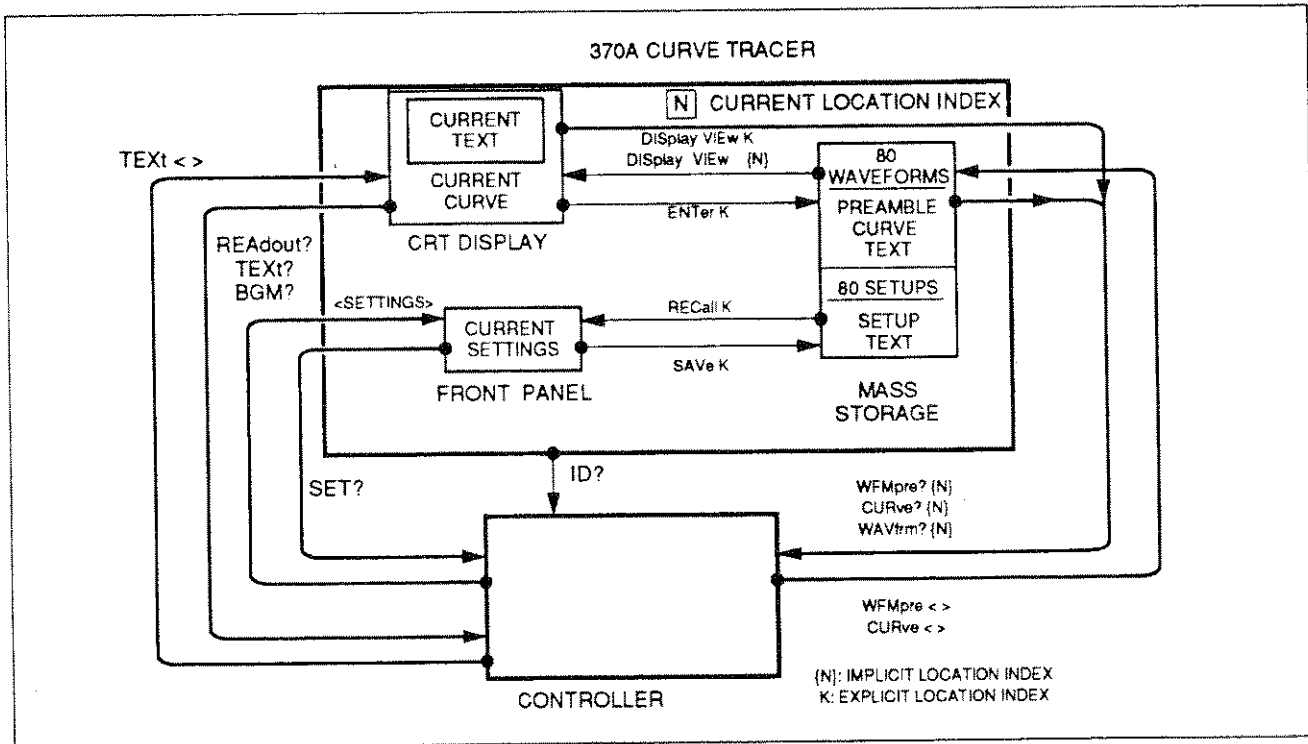

Figure 4-7. Data transfers under GPIB control.

DEVICE-DEPENDENT MESSAGE FORMAT

Device-dependent messages travel both ways between the instrument and controller, and are used to:

- Set instrument controls
- Request and return the instrument status
- Request, return, and send waveforms
- Request and return results of other measurements

Most messages are sent as strings of ASCII characters; however, data representing sets of curves are sent as series of binary-coded numbers.

Commands are sent from the controller to the instrument. Each starts with a key word called a header which is usually followed by an argument to further detail the instruction. The key words used for command headers and arguments are mnemonics related to specific instrument controls and functions. Multiple commands can be sent in one message. Many command headers can be issued with an attached question mark (?), identifying them as queries which prompt the instrument for certain information.

Response to queried either contain information about instrument status or measurement data. Generally, status messages are made up of the same key words used for commands. The only device-dependent message not made up of words or parts of words are those made up of curve data.

Each message ends with the message terminator, which was discussed earlier. In most cases the controller or its language takes care of the message terminator and it is no longer a concern once it has been chosen and set.

Command Message Formats

Commands for the 370A Curve Tracer, like those for other Tektronix GPIB instruments, follow the conventions of the Tektronix Standard Codes and Formats. Each command starts with a key-word header which is often followed by one or more key-word arguments to further specify the action to be taken. The key words for commands were chosen to be as understandable as possible, while still allowing a familiar use to shorten most of them to only a few characters. Syntax is also standardized to make the commands easier to learn.

In most of this section, key words for headers and arguments are listed in a combination of uppercase and lowercase letters. The instrument accepts any abbreviated header or argument containing at least all the characters shown in uppercase. We show them as uppercase for emphasis only. The 370A accepts upper or lower case characters. In many cases, the commands may be expressed in a variety of valid ways.

The following are all valid versions of the INIt command, which resets the 370A to the initial state following power-up.

```
INI
INIT
Ini
Init
ini
init
inIT
```

The Command List portion of this section describes all the 370A commands and queries. In the Command List, the elements of each command and query are listed in tabular format. The first column lists the header key word. The second column lists arguments that may be associated with the command. A third column, if necessary, lists linked arguments. Brief descriptions and examples are shown in the last column.

370A Operator's Manual

Headers

Each command consists of at least a header.

<header>

Each command header is unique and in some cases is all that is needed to invoke the command. For example:

INIt

NOTE

CURSor can be shortened only to four characters. The three characters CUR will be interpreted as CURve.

Arguments

Many commands require the addition of arguments to the header to describe exactly what is to be done. If there is more to the command than just the header, the header must be followed by at least one space. Otherwise, the 370A treats all spaces, linefeeds, and tabs as "white space" and ignores them in analyzing messages from the controller. For example:

<header> <argument>

In some cases, the argument is simply a single word or a number. For example:

CURSor OFF
RQS on
PKPower 220

Linked Arguments

In other cases, the argument itself requires another argument. When an argument to an argument is required, a colon links the two; hence the second is called a linked argument.

<header> <argument>:<linked argument>

DISplay INVert:ON
VERt COLlect:1.0E+0
WFMpre NR.PT:512

Queries

For most commands there is a corresponding query formed by adding a question mark to the header key word. Do not put a space between the last character of the key word and the question mark.

Queries for the 370A need only the header and question mark, though the response will usually be more involved.

<header>?

ID?
HOR?
DEB?
STPgen?

Query:	STP?
Typical Response:	STPGEN NUMBER: 5,PULSE:OFF,OFFSET: 0.00,INVERT:OFF, MULT:OFF, CURRENT:1.0E-3

Multiple Arguments

Where a header has multiple arguments, the successive arguments (or argument pairs if the arguments have linked arguments) must be separated by commas.

<header> <first arg>:<link arg>,
<second arg>:<link arg>

STP CUR: 2E-6,MUL:ON,NUM:5
DIS VIE:10,REF:ON

Numeric Argument Formats

Many Commands have numeric arguments. The numbers are decimal (base 10) values. They are expressed in three different formats, denoted <NR1>, <NR2>, and <NR3>. These formats are shown in Table 4-4.

Table 4-4
Numeric Argument Formats

Symbol	Number Format	Examples
<NR1>	Integer	+1, 2, -1, -10, 0
<NR2>	Explicit decimal point	-3.2, +5.1, 1.2, .0, 0.
<NR3>	Floating point, exponential, or scientific notation	-12.3E-2, .005E-6, 0.000E-3 6.7E+4, 2.35E-3, 0.E0, 125E-6

Generally:

An <NR1> argument must be sent to the 370A in that format (i.e., without a decimal point).

An <NR2> argument may be sent to the 370A in either <NR2> or <NR1> format.

An <NR3> argument may be sent in <NR3>, <NR2> or <NR1> format.

Examples of these argument formats are shown in Table 4-5.

Table 4-5
Argument Format Examples

Command	Valid Forms
RECall <NR1>	REC 12
DISplay VIEw:<NR1	DIS VIE:7
STPgen OFFset:<NR2>	STPGEN OFFSET:5 stp off:3.5
VERt COLlect:<NR3>	VER COL:2 VER COL:0.5 vert collect:1.5E-2

Multiple-Command Messages

Multiple commands may be included in one message by separating individual commands with semicolons. The command examples are shown in different formats to demonstrate the 370A indifference to upper and lower case.

```
<first command>;<second command>;<third
command>
```

```
PKPOWER 10;CSPOL PDC;MEASURE
SINGLE
pkpow 10;cspol pdc;meas single
PKP 10;CSP PDC;MEA SIN
CURSOR OFF;HORIZ COLLECT:1.0E+0;
STPGEN NUMBER:3
```

With multiple commands in the message, the message terminator is needed only once, at the end of the message. Again, most controllers and their languages take care of this.

Other Messages

Besides receiving commands and queries the 370A can receive data and send responses to queries. The data and responses can be quite short (a word and a number) or fairly long (a full set of front-panel settings). Measurement information can also be short (a word and a number) or lengthy (a full display).

ASCII strings. As mentioned before, the only device-dependent messages not sent as ASCII strings are the binary data used for curves. All other messages, both to and from the 370A, are ASCII strings made up of numbers or key words pertaining to the applicable parameters.

Key-word messages. A sample, key-word exchange resulting in a simple response is the following.

```
Query:          PST?
Response:       PSTATUS BUSY
```

Another example follows, this one resulting in a more lengthy response.

370A Operator's Manual

Query: STP?
Response: STPGEN NUMBER:
5,PULSE:OFF,
OFFSET: -1.5,INVERT:OFF,
MULT:OFF,VOLTAGE:2.0E-3

Number message. Numbers other than those representing curves are sent as strings of ASCII characters. Some controllers may require that these be explicitly converted to numeric values for use in calculations. Other controllers or languages may provide a more direct conversion.

Preambles

Preambles are necessary to interpret the numeric information in the curve data that follows them. Within a preamble, 26 parameters are specified. The first ten are unique to the 370A curve tracer and are included as a sub-string linked to the WFID: label. The other 16 parameters include ten that have fixed values and six that vary with the particular data sent.

Within the WFID: sub-string the parameters are separated by slashes, while the entire sub-string is delimited by a pair of double quote marks. Most of the WFID: string is rather strictly defined, with each parameter value being right justified in a fixed length field. An exception is the BGM value, which may vary in field length.

The remainder of the preamble uses standard punctuation. A colon links each parameter label with its corresponding value and the individual label and value pairs are separated with commas.

A complete preamble might look like this:

```
WFMPRE WFID:"INDEX 3/VERT 500mA/  
HORIZ 1V/STEP 2V/OFFSET 0.00V/BGM  
250mS/AUX 0.0/ACQ AVG/VCS 12.3/TEXT  
",ENCDG:BIN,NR.PT:3,PT.FMT:XY,XMULT:+1.0E  
2,XZERO:0,XOFF:12,XUNIT:V,YMULT:+5.0E-  
3,YZERO:0,YOFF:12, YUNIT:A,BYT/  
NR:2,BN.FMT:RP, BIT  
NR:10,CRVCHK:CHKSMO, LN.FMT:DOT
```

Curves

Curve data sets are usually much longer than any other kind. Typically a set of curve data will be about 4122 bytes long, with most of the bytes being binary-coded numbers. Thus, most of the string of data is not directly readable, but must be interpreted by the controller.

An example might look like this.

```
CURVE CURVID:"INDEX  
9",%NNXXYYXXYY . . . XXYYC
```

This example breaks down as follows. It starts with an ASCII string of 25 characters:

```
CURVE CURVID:"INDEX 9",%
```

This is followed by a series of binary bytes. The first of these is two bytes giving the number of data bytes to follow, plus one (typically 4097):

```
NN
```

Then come the 4096 data bytes. Each of the 1024 data points on the curve is represented by four bytes, 2 for the 10 bits of the X coordinate and 2 for the 10 bits of the Y coordinate:

```
XXYYXXYY . . . XXYY
```

And finally there is one byte which is the checksum for the preceding 4098 data bytes.

■ 370A GPIB COMMANDS

Introduction

370A GPIB commands are divided into three classes, the front panel control commands, display data and CRT readout I/O commands, and the system commands. Each class has several command groups, sorted by function.

Front-Panel Control Commands and Queries

Front-panel-related commands and queries are grouped as follows:

- Display Controls
- Cursor Controls
- Collector Supply Controls
- Step Generator Controls
- Configuration
- Measurement
- Others

Table 4-6 relates the front-panel controls to the GPIB commands.

Table 4-6
Front-Panel Control Commands and Queries

Control	Command header
Display Control Command Group	
NON STORE	DISPLAY
STORE	DISPLAY
REF	DISPLAY
VIEW	DISPLAY
INVERT	DISPLAY
CAL ZERO	DISPLAY
CAL OFF	DISPLAY
CAL FULL	DISPLAY
ENTER	ENTER
VERTICAL CURRENT/DIV	VERT
HORIZONTAL VOLTS/DIV	HORIZ
DISPLAY OFFSET	VERT/HORIZ
Cursor Control Command Group	
OFF	CURSOR
DOT	DOT
f LINE	LINE
WINDOW	WINDOW
Collector Supply Control Command Group	
MAX PEAK VOLTS	PKVOLT
MAX PEAK POWER WATTS	PKPOWER
POLARITY	CSPOL
VARIABLE	VCSPPLY
Step Generator Control Command Group	
STEP AMPLITUDE	STPGEN
VOLTAGE	STPGEN
CURRENT	STPGEN
NUMBER OF STEPS	STPGEN
INVERT	STPGEN
STEP MULTI .1X	STPGEN
PULSE	STPGEN
OFFSET	STPGEN
Configuration Command Group	
CONFIGURATION	CONFIG

Control	Command header
Measurement Command Group	
REPEAT	MEASURE
SINGLE	MEASURE
SWEEP	MEASURE
Other Commands	
ACQ MODE	ACQUIRE
MAG	MAG
RECALL	RECALL
SAVE	SAVE
PLOT	PLOT
Plotter status	PSTATUS?
AUX SUPPLY	AUX
LEFT-RIGHT-STANDBY	LRSSW
SWITCH	
PROTECTIVE COVER	COVER?
OUTPUTS	OUTPUTS?

Display-Data and CRT Readout I/O Commands and Queries

These commands and queries display data and CRT readout, and transfer display and readout data to and from the 370A.

Table 4-7
Display-Data and CRT Readout I/O Commands and Queries

Message Unit	Function
Waveform Transfer Command Group	
WFMPRE WFMPRE? CURVE CURVE? WAVEFRM?	Sends waveform parameters to 370A Requests waveform parameters from 370A Sends binary waveform data to 370A Requests binary waveform data from 370A Requests waveform parameters and binary waveform data from 370A
CRT Readout Transfer Command Group	
READOUT? BGM? TEXT TEXT?	Requests cursor readouts from 370A Requests beta or gm/DIV readout from 370A Sends text messages to 370A Requests text messages from 370A

System Commands and Queries

The 370A device-dependent message units set and return parameters of use to the controller in a GPIB system. These commands and queries are listed in Table 4-8 and described in two groups, related to instrument parameters, and status and error reporting.

Table 4-8
System Commands and Queries

Message Unit	Function
Instrument Parameter Command Group	
SET? INIT TEST? ID? HELP? DEBUG, DEBUG? LONG, LONG?	Returns values of setting parameters Resets programmable parameters to power-up values Initiates diagnostic routine Returns model and firmware version number Returns a list of all valid command headers Turns on/off and queries DEBUG function Sets and queries query response form
Status and Error Reporting Command Group	
RQS,RQS? Status Byte OPC,OPC? EVENT?	Turns on/off and queries RQS message function Serial poll response Turns on/off and queries OPC message function Returns error condition reported in last status byte

Command List

Tables 4-9 through 4-11 list all 370A GPIB commands and queries. The first column lists the name or header of the command. The second column lists arguments associated with the command. The third column lists link arguments associated with the first argument. The last column lists brief descriptions of each command and the related argument.

BNF notation is used herein to define communication with the 370A. The symbols are as follows:

- < > Defined element.
- ::= Is defined as.
- { } Grouping.
- [] Optional, may be omitted.
- | Exclusive or (one or the other, but not both).
- ... May be repeated one or more times.

The division of classes and command groups conforms with 370A GPIB Commands discussed earlier.

Table 4-9
Front Panel Controls

DISPLAY COMMAND GROUP			
Command	Argument	Link	Definition
DISPlay	NSTore		Selects NON STORE mode.
	STOre		Selects STORE mode.
	VIEW	<NR1>	Selects VIEW mode. DISPLAY VIEW:<index> <index> ::= 1 2 ... 80
	REF	ON OFF	Displays REF curve. Turns off the REF curve display.
	INVert	ON OFF	Selects display invert mode. Disables display invert mode.
	CAL	ZERo OFF FULL	Sets the CRT check mode.

Table 4-9
Front Panel Controls

DISPLAY COMMAND GROUP (continued)			
Command	Argument	Link	Definition
DISplay?			<p>Responds with display data:</p> <p>DISPLAY <mode1>,<mode2>,<mode3>,<mode4></p> <p><mode1> ::= INVERT:OFF INVERT:ON</p> <p><mode2> ::= CAL:ZERO CAL:OFF CAL:FULL</p> <p><mode3> ::= NSTORE STORE VIEW:<NR1></p> <p><mode4> ::= REF:ON REF:OFF</p>
ENTer	<NR1>		<p>Store the displayed curve data in the memory location specified by the argument.</p> <p>ENTER <index></p> <p><index> ::= 1 2 ... 80</p>
VERt	STEp COLlect	<NRX>	<p>Selects vertical source and amps/div. Requires an NR1-3 type number for amps/div. Will return NR3 in query form.</p> <p>VERT <source>[:<amp>]</p> <p>Current ranges allowed:</p> <p>COLLECT <amp> ::= {1.0E-6 - 2.0E+0} (COLLECTOR POLARITY not leakage mode)</p> <p>COLLECT <amp> ::= {1.0E-9 - 2.0E-3} (COLLECTOR POLARITY leakage mode)</p>
	OFFset	<NR2>	<p>Sets vertical display offset</p> <p>VERT OFFSET:<val></p> <p><val> ::= +/- 10.0 by 0.1</p>
VERt?			<p>Responds with the vertical source, amps/div, and display offset:</p> <p>VERT <source> [:<amp>], OFFSET:<val></p> <p><source> ::= STEP COLLECT</p> <p><amp> ::= amps/div (NR3)</p> <p><val> ::= display offset value</p>

Table 4-9
Front Panel Controls

DISPLAY COMMAND GROUP			
Command	Argument	Link	Definition
HORiz	STEP COLlect BASE	<NRX> <NRX>	Selects the horizontal source and volts/div. Use a NR1-3 type number for volt/div. Returns NR3 in query form. HORIZ <source> [:<volt>] Voltage ranges allowed: COLLECT <volt> ::= {5.0E-2 - 5.0E+2} BASE <volt> ::= {5.0E-2 - 5.0E+0}
	OFFset	<NR2>	Sets horizontal display offset HORIZ OFFSET:<val> <val> ::= +/- 10.0 by 0.1
HORiz?			Responds with horizontal source, volts/div and display offset: HORIZ <source> [:<volt>], OFFSET:<val> <source> ::= STEP COLLECT BASE <volt> ::= volts/div (NR3) <val> ::= display offset value
CURSOR CONTROL COMMAND GROUP			
CURSor	OFF		Currently displayed cursor disappears. CURSOR OFF
DOT	<NR1>		Sets the Dot cursor on the specified curve data position. DOT <data> <data> ::= curve data position {1 - 1024}
DOT?			Responds with the Dot cursor position: DOT <NR1>
LINE	<NR1>, <NR1>		Sets the Line cursor intercept position on the display. LINE <data1>, <data2> <data1> ::= horizontal position {0 - 1000} <data2> ::= vertical position {0 - 1000}

Table 4-9
Front Panel Controls

CURSOR CONTROL COMMAND GROUP (continued)			
Command	Argument	Link	Definition
LINE?			Responds with the f Line cursor intercept position: LINE <NR1>,<NR1>
WINDOW	<NR1>, <NR1>, <NR1>, <NR1>		Sets the Window cursor to the specified position on the CRT. WINDOW <data1>,<data2>,<data3>,<data4> <data1> ::= Lower-left horizontal {0 - 1000} <data2> ::= Lower-left vertical {0 - 1000} <data3> ::= Upper-right horizontal {0 - 1000} <data4> ::= Upper-right vertical {0 - 1000}
WINDOW?			Responds with the Window position: WINDOW <NR1>,<NR1>,<NR1>,<NR1>
COLLECTOR SUPPLY CONTROL COMMAND GROUP			
PKVOLT	16 80 400 2000		Sets maximum peak volts. PKVOLT <set> <set> ::= 16 80 400 2000
PKVOLT?			Responds with maximum peak volts: PKVOLT <set> <set> ::= 16 80 400 2000
PKPOWER	220.0 50.0 10.0 2.0 0.08		Sets max peak power in watts. PKPOWER <set> <set> ::= 220.0 50.0 10.0 2.0 0.40.4 0.08
PKPOWER?			Responds with max peak watts: PKPOWER <set> <set> ::= 220.0 50.0 10.0 2.0 0.4 0.08

Table 4-9
Front Panel Controls

CURSOR CONTROL COMMAND GROUP (continued)			
Command	Argument	Link	Definition
CSPol	PLEakage PDC PNormal AC NNormal NDC NLEakage		Selects collector supply polarity and mode. CSPOL <mode> <mode> ::= PLE PDC PNO AC NNO NDC NLE PLE ::= +LEAKAGE, PDC ::= +DC, PNO ::= +(fullwave), AC ::= AC, NNO ::= -(fullwave), NDC ::= -DC, NLE ::= -LEAKAGE
CSPol?			Reports collector supply polarity and mode: CSPOL <mode> <mode> ::= PLEAKAGE PDC PNORMAL AC NNORMAL NDC NLEAKAGE
VCSply	<NR2>		Sets the variable collector supply. The argument data is a percentage value. VCSPPLY <data> <data> ::= 0.0 - +100.0 (by 0.1 %)
VCSply?			Reports variable collector supply volts: VCSPPLY <data> <data> ::= 0.0 - +100.0 (by 0.1 %)
STEP GENERATOR COMMAND GROUP			
STPgen	CURrent VOLTage	<NRX> <NRX>	Sets step generator source to<amps/step> or <volts/step>. Requires NR1-3 input. STPGEN <source> :<val> Step ranges allowed: CURRENT <val> ::= {5.0E-8 - 2.0E-1} VOLTAGE <val> ::= {5.0E-2 - 2.0E+0}
	NUMber	<NR1>	No. of steps to be generated. STPGEN NUMBER:<val> <val> ::= 0 1 2 ... 10

Table 4-9
Front Panel Controls

STEP GENERATOR COMMAND GROUP (continued)			
Command	Argument	Link	Definition
STPgen (continued)	INVert	ON OFF	Sets step generator invert mode. STPGEN INVERT:<mode>
	MULT	ON OFF	Sets step generator .1X mode. STPGEN MULT:<mode>
	PULse	OFF SHORT LONG	Pulse duration 80 μ s. 300 μ s. STPGEN PULSE:<mode>
	OFFset	<NR2>	Sets Step Generator Offset. STPGEN OFFSET:<val> <val> ::= {+/- 10.00 by 0.01}
STPgen?			Reports Step Generator source, amps/step or volts/step, output, number of steps, pulse mode, offset, invert mode, .1X mode. STPGEN NUMBER:<num>, PULSE:<pulse>, OFFSET:<offset>, INVERT:<invert>, MULT:<mult>,<amp> <num> ::= number of steps (NR1) <pulse> ::= pulse mode (OFF SHORT LONG) <offset> ::= step generator offset (NR2) <invert> ::= step generator invert mode (ON OFF) <mult> ::= step generator .1X mode (ON OFF) <amp> ::= CURRENT:amps/step VOLTAGE:volts/step

Table 4-9
Front Panel Controls

CONFIGURATION COMMAND GROUP			
Command	Argument	Link	Definition
CONfig	BSGen BOPen BSHort EOPen ESGen BColl		Sets Configuration mode. CONFIG <mode> <mode> ::= BSG BOP BSH EOP ESG BSG ::= BASE STEP GEN & EMITTER COMMON BOP ::= BASE OPEN & EMITTER COMMON BSH ::= BASE SHORT & EMITTER COMMON EOP ::= BASE COMMON & EMITTER OPEN ESG ::= BASE COMMON & EMITTER STEP GEN BCO ::= BASE COLLECTOR SUPPLY & EMITTER COMMON
CONfig?			Reports configuration CONFIG <mode> <mode> ::= BSGEN BOPEN BSHORT EOPEN ESGEN BCOLL
MEASUREMENT COMMAND GROUP			
MEASURE	REPEAT SINGLE SWEEP		Selects measurement mode. MEASURE <mode> <mode> ::= REPEAT SINGLE SWEEP
MEASURE?			Reports measurement mode: MEASURE REPEAT SINGLE SWEEP
OTHER COMMANDS			
ACQUIRE	ENVELOPE NORMAL AVG	VERT HORIZ	Sets the acquisition mode.
ACQUIRE?			Responds with the acquisition mode: ACQUIRE <mode> [:<val>] <mode> ::= ENVELOPE NORMAL AVG <val> ::= VERT HORIZ
MAG	ON OFF		Turns X10 Magnification on or off.

Table 4-9
Front Panel Controls

OTHER COMMANDS			
Command	Argument	Link	Definition
MAG?			Responds with the magnifier mode: MAG <mode> <mode> ::= ON OFF
RECall	<NR1>		Recall front-panel setup data from memory location stated by argument. RECALL <index> <index> ::= 1 2 ... 80
SAVe	<NR1>		Store the displayed setup data in the memory location stated by argument. SAVE <index> <index> ::= 1 2 ... 80
PLOt	ALL CURve		Selects the plotter interface mode, curve only or curve plus readout and graticule, and start the output to the plotter. PLOT ALL CURVE ALL ::= Curve with readout data and graticule CUR ::= Curve only
PStatus?			Reports plotter status PSTATUS READY BUSY READY ::= idle mode BUSY ::= busy mode
AUX	<NR2>		Sets AUX output voltage to argument value. <NR2> = ± 40.00 by 0.02 increments.
AUX?			Reports AUX output voltage: AUX <data> <data> ::= ± 40.00 (0.02 step)
LRSsw			Selects the device to be tested (left or right). LRSSW LEFT RIGHT STANDBY
LRSsw?			Reports LEFT-RIGHT-STANDBY switch status LRSSW LEFT RIGHT STANDBY

Table 4-9
Front Panel Controls

OTHER COMMANDS (continued)			
Command	Argument	Link	Definition
COVer?			Reports protective cover status COVER ON OFF ON for cover closed OFF for cover open
OUTputs?			Responds with the OUTPUTS breaker status. OUTPUTS ENABLED DISABLED ENABLED := OUTPUTS breaker is enabled DISABLED := OUTPUTS breaker is disabled

Table 4-10
Display Data and CRT Readout I/O

WAVEFORM TRANSFER COMMAND GROUP			
Command	Argument	Link	Definition
WFMpre	<string>		<p>Load waveform preamble data. WFMpre WFID:<wfid>,ENCDG:BIN, NR.PT:<point>,PT.FMT:XY, XMULT:<x multi>,XZERO:0, XOFF:<x off>,XUNIT:V, YMULT:<y multi>,YZERO:0, YOFF:<y off>,YUNIT:A,BYT/NR:2, BN.FMT:RP,BIT/NR:10,CRVCHK:CHKSMO, LN.FMT:<format></p> <p><wfid> ::= "INDEX <num>/VERT<amp>/ HORIZ <volt>/ STEP<step>/OFFSET<offset>/BGM<para>/ AUX<aux>/ACQ<acq>/VCS <percent>/TEXT <txt>"</p> <p><num> ::= Memory location number <amp> ::= Vertical amps/div <volt> ::= Horizontal volts/div <step> ::= Step amplitude <offset> ::= Step offset <para> ::= Beta or gm <aux> ::= Aux Supply <acq> ::= Curve acquisition mode (AVG NOR ENV) <percent> ::= Variable Collector Supply setting, % <txt> ::= Text area readout <point> ::= curve point no. (1 - 1024) <x multi> ::= <NR3>= horizontal scale factor <x off> ::= <NR1>= horizontal scale offset <y multi> ::= <NR3>= vertical scale factor <y off> ::= <NR1>= vertical scale offset <format> ::= VECTOR DOT SWEEP <num><num> ::= number of steps + 1</p>
WFMpre	NR.PT	<NR1>	Sets input points no. from curve command (1 to 1024)

Table 4-10
Display Data and CRT Readout I/o

WAVEFORM TRANSFER COMMAND GROUP			
Command	Argument	Link	Definition
WFMpre?			<p>When WFMpre? is received, 370A reports waveform preamble data:</p> <p>WFMPRE WFID:<wfid>,ENCDG:BIN, NR.PT:<point>,PT.FMT:XY, XMULT:<x multi>,XZERO:0, XOFF:<x off>,XUNIT:V, YMULT:<y multi>,YZERO:0, YOFF:<y off>,YUNIT:A,BYT/NR:2, BN.FMT:RP,BIT/ NR:10,CRVCHK:CHKSMO, LN.FMT:<format></p> <p><wfid> ::= "INDEX <num>/VERT<amp>/ HORIZ <volt>/ STEP<step>/OFFSET<offset>/BGM<para>/ AUX<aux>/ACQ<acq>/VCS <percent>/ TEXT <txt>"</p> <p><num> ::= Memory location number (0 - 70, 0 for CRT) <amp> ::= Vertical amp/div <volt> ::= Horizontal volts/div <step> ::= Step amplitude <offset> ::= Step offse <para> ::= Beta or gm <aux> ::= Aux Supply <acq> ::= Curve acquisition mode (AVG NOR ENV) <percent> ::= Variable Collector Supply setting, % <txt> ::= Text area readout <point> ::= curve point no. (1 - 1024) <x multi> ::= <NR3> = horizontal scale factor <x off> ::= <NR1> = horizontal scale offset <y multi> ::= <NR3> = vertical scale factor <y off> ::= <NR1> = vertical scale offset <format> ::= VECTOR DOT SWEEP <num> <num> ::= number of steps + 1</p>
WFMpre?	NR.PT		<p>Reports NR.PT waveform preamble data.</p> <p>WFMPRE NR.PT:<point> <point> ::= 1 2 ... 1024</p>
CURve	<string>		<p>Loads curve data.</p> <p>CURVE CURVID:<crvid>, %<binary data> <crvid> ::= "INDEX <NR1>" <binary data> ::= <binary count> <binary point>...<checksum></p>

Table 4-10
Display Data and CRT Readout I/o

WAVEFORM TRANSFER COMMAND GROUP (continued)			
Command	Argument	Link	Definition
CURve?			<p>Reports curve data.</p> <p>CURVE CURVID:<crvid>, %<binary count> <binary point>...<checksum></p> <p><crvid> ::= "INDEX <NR1>"</p> <p><binary count> ::= two bytes representing no. of data points + 1</p> <p><binary point> ::= 8-bit byte (001...1FF)</p> <p><checksum> ::= 2's complement of the modulo 256 sum of the preceding binary data bytes and binary count, except "%" preceding the binary data count.</p>
WAVfrm?			<p>Reports waveform preamble and curve data. Response is the same as is returned for WFMpre?;CURVE?</p>
CRT READOUT TRANSFER COMMAND GROUP			
READout?	STRing SCientific		<p>Sends displayed cursor readout.</p> <p>The response can be specified to be in either string or scientific notation format.</p> <p>If the cursor is offscreen, the returned values will be preceded by question marks and are not valid.</p> <p>READOUT <xread>,<yread></p> <p><xread> ::= horizontal reading in volts</p> <p><yread> ::= vertical reading in amperes (or ohms for f LINE cursor)</p> <p>When queried with the SCientific argument, the responses <xread> and <yread> are <NR3>.</p>
BGM?			<p>Responds with the B or gm/DIV readout.</p> <p>BGM <para> <para> is <NR1></p>
TEXT	<string>		<p>Displays text on CRT.</p> <p>Text "<text>"</p> <p><text> ::= max. 24 characters</p>
TEXT?			<p>Reports text on CRT.</p> <p>Text "<text>"</p> <p><text> ::= max. 24 characters</p>

Table 4-11
System Commands and Queries

INSTRUMENT PARAMETER COMMAND GROUP																																																										
Command	Argument	Link	Definition																																																							
SET?			<p>Reports front-panel settings.</p> <p>Response is the same as return for OPC?;RQS?; DEBUG?;LONG?;OUTPUTS?;LRSSW?;CONFIG?; CSPOL?;ACQUIRE?;HORIZ?;VERT?;MAG?; STPGEN?;PKPOWER?;PKVOLT?;AUX?;VCSPPLY?; MEASURE?;DISPLAY?;TEXT? followed by cursor mode response.</p>																																																							
INIT			<p>Resets instrument as if the power was turned off, then turned back on.</p> <p>Instrument functions are reset as shown below.</p>																																																							
			<table border="1"> <thead> <tr> <th>Function</th> <th>INIT Val</th> </tr> </thead> <tbody> <tr><td>DISPLAY</td><td>STORE</td></tr> <tr><td>CURSOR</td><td>OFF</td></tr> <tr><td>DISPLAY CAL:</td><td>OFF</td></tr> <tr><td>DISPLAY INVERT:</td><td>OFF</td></tr> <tr><td>MEASURE</td><td>REPEAT</td></tr> <tr><td>ACQUIRE</td><td>NORMAL</td></tr> <tr><td>MAG</td><td>OFF</td></tr> <tr><td>VERT OFFSET:</td><td>0.0</td></tr> <tr><td>HORIZ OFFSET:</td><td>0.0</td></tr> <tr><td>VERT COLLECTOR:</td><td>2.0E+0</td></tr> <tr><td>HORIZ COLLECTOR:</td><td>2.0E+0</td></tr> <tr><td>STPGEN CURRENT:</td><td>50.0E-9</td></tr> <tr><td>STPGEN OFFSET:</td><td>0.0</td></tr> <tr><td>STPGEN MULTI:</td><td>OFF</td></tr> <tr><td>STPGEN PULSE:</td><td>OFF</td></tr> <tr><td>STPGEN INVERT:</td><td>OFF</td></tr> <tr><td>STPGEN NUMBER:</td><td>5</td></tr> <tr><td>VCSPPLY</td><td>0.0</td></tr> <tr><td>PKVOLT</td><td>16</td></tr> <tr><td>PKPOWER</td><td>0.08</td></tr> <tr><td>CSPOL</td><td>PNORMAL</td></tr> <tr><td>CONFIG</td><td>BSGEN</td></tr> <tr><td>AUX</td><td>0.00</td></tr> <tr><td>LRSSW</td><td>STANDBY</td></tr> <tr><td>OPC</td><td>OFF</td></tr> <tr><td>RQS</td><td>ON</td></tr> <tr><td>LONG</td><td>ON</td></tr> <tr><td>DEBUG</td><td>OFF</td></tr> </tbody> </table>	Function	INIT Val	DISPLAY	STORE	CURSOR	OFF	DISPLAY CAL:	OFF	DISPLAY INVERT:	OFF	MEASURE	REPEAT	ACQUIRE	NORMAL	MAG	OFF	VERT OFFSET:	0.0	HORIZ OFFSET:	0.0	VERT COLLECTOR:	2.0E+0	HORIZ COLLECTOR:	2.0E+0	STPGEN CURRENT:	50.0E-9	STPGEN OFFSET:	0.0	STPGEN MULTI:	OFF	STPGEN PULSE:	OFF	STPGEN INVERT:	OFF	STPGEN NUMBER:	5	VCSPPLY	0.0	PKVOLT	16	PKPOWER	0.08	CSPOL	PNORMAL	CONFIG	BSGEN	AUX	0.00	LRSSW	STANDBY	OPC	OFF	RQS	ON	LONG
Function	INIT Val																																																									
DISPLAY	STORE																																																									
CURSOR	OFF																																																									
DISPLAY CAL:	OFF																																																									
DISPLAY INVERT:	OFF																																																									
MEASURE	REPEAT																																																									
ACQUIRE	NORMAL																																																									
MAG	OFF																																																									
VERT OFFSET:	0.0																																																									
HORIZ OFFSET:	0.0																																																									
VERT COLLECTOR:	2.0E+0																																																									
HORIZ COLLECTOR:	2.0E+0																																																									
STPGEN CURRENT:	50.0E-9																																																									
STPGEN OFFSET:	0.0																																																									
STPGEN MULTI:	OFF																																																									
STPGEN PULSE:	OFF																																																									
STPGEN INVERT:	OFF																																																									
STPGEN NUMBER:	5																																																									
VCSPPLY	0.0																																																									
PKVOLT	16																																																									
PKPOWER	0.08																																																									
CSPOL	PNORMAL																																																									
CONFIG	BSGEN																																																									
AUX	0.00																																																									
LRSSW	STANDBY																																																									
OPC	OFF																																																									
RQS	ON																																																									
LONG	ON																																																									
DEBUG	OFF																																																									

Table 4-11
System Commands and Queries

INSTRUMENT PARAMETER COMMAND GROUP (continued)			
Command	Argument	Link	Definition
TEST?			Initiates ROM and RAM check routine. TEST ROM:<hex>,RAM:<hex>
ID?			Reports the instrument ID: ID SONY_TEK/370A,V81.1,<fwv> <fwv> ::= current firmware version
HELp?			Reports list of all valid command headers: HELP CONFIG,READOUT,BGM,TEXT,LINE,DOT, WINDOW,CURSOR,DISPLAY,ACQUIRE,MAG, HORIZ,VERT,STEPGEN,MEASURE,ENTER,RECALL, SAVE,PLOT,PSTATUS,OUTPUTS,LRSSW,COVER,AUX, PKVOLT,PKPOWER,CSPOL,VCSPLY,WFMPRE, CURVE,WAVFRM,RQS,OPC,EVENT,TEST,INIT,ID, DEBUG,LONG,SET
DEBug	ON OFF		Enables or disables the debug feature. DEBUG ON OFF
DEBug?			Responds with the status of the debug mode. DEBUG <status> <status> ::= ON OFF
LONG	ON OFF		Determines whether a response to a query is given with unabbreviated (ON) or not. LONG ON OFF
LONG?			Reports the current status of the query response form. LONG ON LON OFF

Table 4-11
System Commands and Queries

STATUS AND ERROR REPORTING COMMAND GROUP			
Command	Argument	Link	Definition
RQS	ON OFF		Enable service requests. Disable service requests.
RQS?			Reports RQS status. RQS ON OFF
OPC	ON OFF		Enables operation-complete service request. Disables operation-complete service request.
OPC?			Reports OPC status. OPC ON OFF
EVENT?			Returns detailed information about the event. EVENT <code> <code> ::= See Table 4-13.

■ SERVICE REQUESTS

The standard GPIB status and error reporting system used by the 370A sends interrupt messages to the bus controller by asserting the Service Request (SRQ) line on the bus. This SRQ message indicates that either an error or a change in status has occurred.

Handling Service Requests

To service an interrupt, the controller "polls" the instruments on the bus. The instrument asserting SRQ, the 370A in this case, returns a status byte indicating the category of the event causing the Service Request. Each Service Request is automatically cleared after responding to the poll. If there is more than one event to report, the instrument re-asserts SRQ until all pending events have been reported. A complete list of status bytes that can occur is found in Table 4-12.

After polling the 370A for the status byte, the controller can obtain more detailed information about the Service Request event by sending the EVENT? query. The response to an EVENT? query is an event code, which is a <NR1> number corresponding to certain conditions that may have occurred. Table 4-13 lists the event codes returned by the 370A.

The status byte and event code can be accessed later if they are not read and cleared immediately. In the case of multiple events, only the latest status byte and the one pending are saved. Event codes, however, are kept in a ten-deep Last-In-First-Out (LIFO) buffer for later recall.

The following program segments demonstrate how Service Requests are handled along with the corresponding status byte and event code. The status byte and event code are printed on the controller display to track instrument status.

IBM PC: (This is for use with the auto-serial-poll flag disabled in the National Instruments GPIB card configuration file.)

```
800 REM *** SIMPLE SRQ HANDLER FOR
      370A ***
810 CALL IBASP(BD$,SPR$)
820 WRT$="EVENT?"
830 CALL IBWRT(BD$,WRT$)
840 RD$=SPACE$(100)
850 CALL IBRD(BD$,RD$)
860 PRINT "STATUS=";SPR$,"EVENT=";RD$
```

Hewlett Packard 200/300 Series:

```
800 REM *** SIMPLE SRQ HANDLER FOR
      370A ***
810 STB=SPOLL(DEU)! Poll device previously defined.
820 OUTPUT DEU;"EVENT?",END ! Send "EVENT?" query.
830 ENTER DEU;EVENT$ ! Input response.
840 PRINT "STATUS=";STB;" EVENT=";EVENT$ ! Show status and event.
```

Masking Service Requests

The Operation Complete Service Request (OPC SRQ) is a special type of Service Request to communicate that certain instrument processes have been finished. These OPC Service Requests indicate that the 370A has finished one operation and is ready to proceed to the next.

It may not always be desirable to interrupt the program with Service Requests or OPC Service Requests. Either type of Service Request can be masked so that the 370A will not assert them until the mask is removed. This masking is accomplished with the RQS and OPC commands.

370A Operator's Manual

RQS ON enables the 370A to assert an SRQ when it has an event to report. If this feature is turned off (RQS OFF), up to ten events are still accumulated and can be retrieved with successive EVENT? queries.

OPC ON enables the 370A to assert an OPC SRQ upon completion of an operation.

NOTE

The response to RQS? and OPC? queries only indicates whether the function is enable (ON) or disable (OFF). They do not give any other status or event information.

Status Bytes

Table 4-12
Status Byte Responses

8 7 6 5 4 3 2 1	Decimal	Condition
0 0 0 0 0 0 0 0	0	No status to report
0 1 0 0 0 0 0 1	65	Power on
0 1 0 0 0 0 1 0	66	Operation-complete
0 1 0 0 0 0 1 1	67	User request
0 1 0 0 0 1 0 0	68	Plotter output complete
0 1 0 0 0 1 0 1	69	Collector supply recover
0 1 1 0 0 0 0 1	97	Command error
0 1 1 0 0 0 1 0	98	Execution error
0 1 1 0 0 0 1 1	99	Internal error
1 1 0 0 0 0 0 0	192	Device-dependent event

Bit 1 through 4 are the four-bit status code;

Bit 6 indicates abnormal (1), normal (0) condition;

Bit 7 indicates SRQ asserted (depends on RQS command)

No status to report — This status byte is set when there are no event or device-dependent events to report.

Power on — This occurs when the power is turned off, then turned back on.

Operation-complete — This status byte is set when certain operation is complete.

User request — Occurs when the front-panel SINGLE button is pressed while holding down the FAST/SHIFT button.

Plotter output complete — This status byte is set when the 370A completes a plotter output operation.

Collector supply recover — This status byte is set when PLL error or Series-resistor overheat error is recovered.

Command error — This status byte is set when a message cannot be parsed or recognized.

Execution error — This status byte is set when a message is parsed and is recognized, but cannot be executed, such as AUX 50.

Internal error — This status byte indicates that a malfunction has been discovered that could cause the instrument to operate incorrectly.

Device-dependent event — This status byte is set when there is an event specific to the 370A.

Event Codes

Table 4-13
Status Byte and Event Code





Status byte	Event code	Meaning
System Event		
0	0	No error
65	401	Power on
66	402	Measure single operation complete (mask OPC)
66	406	Measure sweep operation complete (mask OPC)
	407	Disk format operation complete (mask OPC)
67	403	User request (FAST + SINGLE button)
68	404	Plotter output complete
69	405	Collector Supply recovered
Command Error		
	101	Command header error
	103	Command argument error
97	106	Command syntax error
	108	Checksum error
	109	Byte count error
Execution error		
	201	Command not executable in local mode
98	203	Output buffer overflow; remaining output lost
	204	Setting conflicts
	205	Argument out of range
	206	Floppy I/O error
	207	NR.PT byte count mis match
	250	Non-volatile memory I/O error
Internal Error		
99	303	Phase-lock system failed
	305	Series Resistor is overheated
	306	Plotter fail
	350	Outputs protected
	307	Collector Supply short
Device-dependent Event		
192	750	Interlock system changed (mask OPC)
	751	OUTPUTS breaker changed (mask OPC)
	752	LEFT-RIGHT-STANDBY switch changed (mask OPC)
	753	Disk format operation complete (mask OPC)
	754	Outputs resumed (mask OPC)

Section 5 Options

5 Options

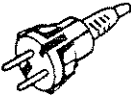
The following options are available:

- Option 1R Rack Mounting Adapter
- Option A1 - A5 International Power Cords:

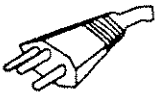
Plug Configuration	Usage	Nominal Line Voltage (AC)	Reference Standards	Option #
	North American 120V/15A	120 V	ANSI C73.11 NEMA 5-15-P IEC 83	Standard
	Universal Euro 220V/16A	240 V	CEE(7),II,IV,VII IEC83	A1
	UK 240V/13A	240 V	BS 1363 IEC 83	A2
	Australian 240V/10A	240 V	AS C112	A3
	North American 240V/15A	240 V	ANSI C73.20 NEMA 6-15-P IEC 83	A4
	Switzerland 220V/10A	220 V	SEV	A5

ANSI - American National Standards Institute

NEMA - National Electrical Manufacturer's Association

IEC - International Electrotechnical Commission

CEE - International Commission on Rules for the Approval of Electrical Equipment

BS - British Standards Institution

AS - Standards Association of Australia

SEV - Schweizerischer Electrotechischer Verein

370A Operator's Manual

This instrument is safety class 1 equipment (IEC* designation). All accessible conductive parts are directly connected through the grounding conductor of the power cord to the grounding contact of the power plug. Therefore, the power plug must only be inserted in a mating receptacle with a grounding contact. Do not defeat the grounding connection. Any interruption of the grounding connection can create an electric shock hazard.

For electric shock protection, connect the instrument to ground before connecting to the instrument input or output terminals.

*International Electrotechnical Commission.

Appendix A

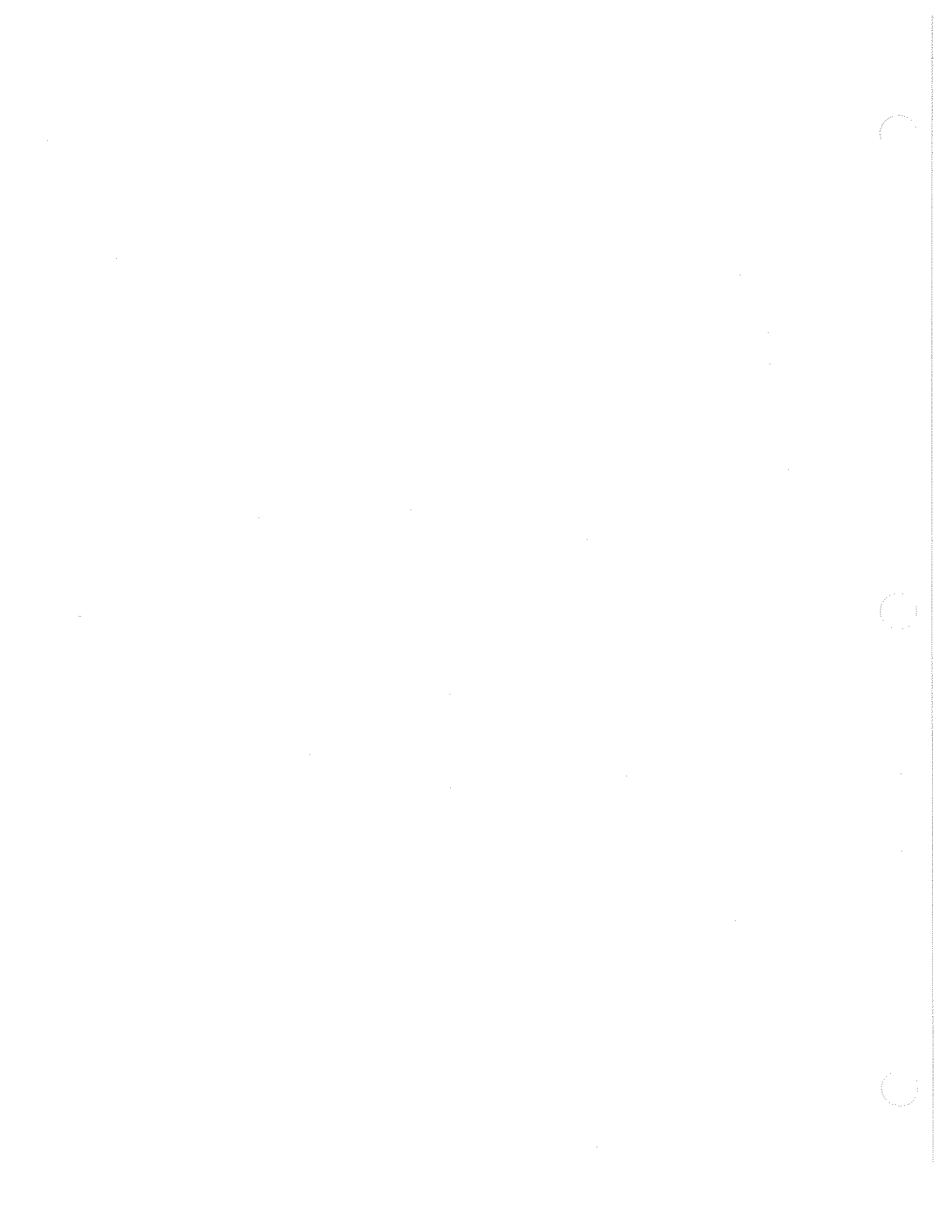

Appendix A

Diagnostic Routines and Messages

This appendix explains the 370A diagnostic routines and lists the messages displayed on the error message area of the CRT when the 370A detects operation errors, I/O errors, or emergency errors.

■ DIAGNOSTIC ROUTINES

The 370A has four diagnostic routines: two kinds of power-on diagnostic routines, a user-initiated diagnostic routine, and GPIB diagnostic routine.

Power-on Diagnostic Routines

At power on, the 370A runs the Power On Diagnostic routine to execute the following tests:

- System ROM check
- System RAM check
- Display RAM check
- Acquisition RAM check
- Push button test

After completing the Power-on Diagnostic routines, the 370A displays a "SELFTTEST PASS" message at the error message area of the CRT and sets the initial front-panel setup.

If the 370A power is turned on while the FAST/SHIFT button is pressed, a more detailed Power-on Diagnostic routine occurs in the following order:

- System ROM check
- System RAM check
- Display RAM check
- Acquisition RAM check
- LED check
- Display quality check
- Push button test

To exit this diagnostic routine, press the FAST/SHIFT button.

System ROM check

After confirming that the system ROMs are without fault, the 370A diagnoses the system ROMs by checksum. If a system ROM fatal error is found (such as misinsertion), the memory index display alternately blinks 0 and 1.

If a checksum error is found, the appropriate error message is displayed in the CRT error message area. The message format follows:

ROM 000X

The 370A does not advance to the next routine.

System RAM check

The 370A checks the system RAM by read/write operation. When a system RAM fatal error is found (such as bus shorted), the memory index display alternately blinks 0 and 2, and the 370A does not advance to the next routine. When read/write errors are found, the error message is displayed in the CRT error message area. The message format follows:

RAM XXXXX YYYY

Display RAM check

The 370A checks the Display RAM by read/write operation. When a read/write error is found (such as bus shorted), the memory index display alternately blinks 0 and 3, and the 370A does not advance to the next routine.

Acquisition RAM check

The 370A checks the Acquisition RAM by a read/write operation. When a read/write error is found (such as bus shorted), the memory index display alternately blinks 0 and 4, and the 370A does not advance to the next routine.

Table A-1 shows the Power on System Error Messages displayed on the memory index display.

**Table A-1
Power on System Error Messages**

Display	Description
0/1 (blink)	System ROM error (e.g., misinsertion)
0/2 (blink)	System RAMs error (e.g., bus shorted)
0/3 (blink)	Display RAM Read/Write error (e.g., bus shorted)
0/4 (blink)	Acquisition RAM Read/Write error (e.g., bus shorted)

LED check

The 370A sequentially lights all front-panel LEDs for visual check.

Display quality check

The 370A displays the Logo mark (SONY/TEKTRONIX), and a CRT adjustment pattern on the CRT for CRT control adjustment. When the adjustment is finished, press FAST/SHIFT to exit this routine.

Push button test

The 370A executes this test (FAST/SHIFT button are not tested here). If an error is found, the error message is displayed at the bottom of the CRT. The Error Message is in the following format:

<STRING> KEY ERROR

<STRING> identifies the front-panel control as listed in Table A-2.

The following also appears, in the CRT text area.

PRESS FAST KEY TO GO ON

You can ignore the displayed error and carry out the measurement by pressing the FAST/SHIFT button, but the displayed function may not operate correctly.

User Initiated Diagnostic Routine

Simultaneously pressing the FAST/SHIFT and Position DISPLAY buttons enters the user-initiated diagnostic routine. This routine displays a message that corresponds to the front panel control that you have just operated. Thus, you can determine if the front panel controls are operating normally. Table A-2 lists the controls and the corresponding messages. To exit this routine, press both the FAST/SHIFT button and the Position DISPLAY button again.

Table A-2
Front Panel Control Identification

Control	Message
Display NON STORE	NON STORE
Display STORE	STORE
Display REF	REF
Display VIEW	VIEW
Display ENTER	ENTER
Display INVERT	INVERT
MEMORY up	MEMORY up
MEMORY down	MEMORY down
Setup SAVE	SAVE
Setup RECALL	RECALL
MAX PEAK VOLTS up	PEAK VOLTS up
MAX PEAK VOLTS down	PEAK VOLTS down
MAX PEAK POWER WATTS up	PEAK WATTS up
MAX PEAK POWER WATTS down	PEAK WATTS down
Collector Supply POLARITY up	POLARITY up
Collector Supply POLARITY down	POLARITY down
GPIB LOCAL	LOCAL
GPIB PLOT	PLOT
ACQ MODE (STORE MODE) up	ACQ MODE up

Control	Message
ACQ MODE (STORE MODE) down	ACQ MODE down
Measurement REPEAT	REPEAT
Measurement SINGLE	SINGLE
Measurement SWEEP	SWEEP
MAG	MAG
FAST/SHIFT	FAST/SHIFT
NUMBER OF STEPS up	# OF STEPS up
NUMBER OF STEPS down	# OF STEPS down
Step Generator VOLTAGE	VOLTAGE
Step Generator CURRENT	CURRENT
Step Generator OFFSET OPPOSE	OPPOSE
Step Generator OFFSET AID	AID
Step Generator POLARITY	STEP POLARITY
Step Generator MULTISTEP	MULTI
Step Generator PULSE	PULSE up
AUX up	AUX up
AUX down	AUX down
CURSOR Mode up	CURSOR up
CURSOR Mode down	CURSOR down
Position CURSOR	CURSOR
Position DISPLAY	DISPLAY
Position Control up	POSITION up

Table A-2 (continued)
Front Panel Control Identification

Control	Message
Position Control left	POSITION left
Position Control down	POSITION down
Position Control right	POSITION right
CONFIGURATION up	CONFIGURATION up
CONFIGURATION down	CONFIGURATION down
LEFT	LEFT
STANDBY	STANDBY
RIGHT	RIGHT
INTERLOCK	COVER ON COVER OFF
VERTICAL CURRENT/DIV	VERTICAL XX (0-16)
HORIZONTAL VOLTS/DIV	HORIZONTAL XX (0-16)
STEP AMPLITUDE	STEP AMP XX (0-16)
VARIABLE COLLECTOR SUPPLY	VARIABLE XX (0-25)
OUTPUTS	OUTPUT ENABLE OUTPUT DISABLE
PROTECTIVE COVER	COVER ON COVER OFF

GPIB diagnostic routine

The GPIB TEST? command initiates the 370A system ROMs and RAMs diagnostic routine. The 370A responds to this command by returning system ROM and RAM information to the controller as follows:

TEST ROM:000X, RAM:YYYY

■ MESSAGES

Typical messages displayed in the CRT error message area while the 370A is in operation are listed in Table A-3.

Table A-3
Messages

Message	Description
OUTPUT ENABLE	OUTPUTS breaker is set to the ENABLED position.
OUTPUT DISABLE	OUTPUTS breaker is set to the DISABLED position.
OUTPUT UNMATCH	OUTPUTS breaker setting does not conform to saved setting at recall. Set the OUTPUTS breaker to conform with the saved setting.
COL. DISABLED	COLLECTOR SUPPLY is disabled. Wait until the message "COL. RECOVERED" is displayed. If the error persists, contact nearest Tektronix Field Service Representative.
COL. RECOVERED	Collector Supply recovered.
ENTER COMPLETE	The displayed curve is saved in the mass storage.
SAVE COMPLETE	The current front-panel setting is saved in the mass storage.
OPERATION ERR.	Operation error
PLL UNLOCK	PLL unlock

Message	Description
ERASE COMPLETE	The non-volatile IC memory is erased.
ERASE CANCELED	Erasing the non-volatile IC memory is canceled.
PLOT START	Plotter output is started.
PLOT ABORTED	Plotter output is aborted.
USER REQUEST	Service request is sent.
PLOT COMPLETE	Plotter output complete.
SELFTEST PASS	The 370A Power-on diagnostic test is successful.
SELFTEST START	The 370A initiates the Power-on diagnostic routine.
COL. OVERHEAT	Series resistor (Collector Supply) overheat. Wait until "COL. RECOVERED" message is displayed.
TEXT CANCELED	Text mode is canceled; text entered is lost.
NVM DATA EMPTY	Non-volatile memory has no data in the location specified by Memory index.
CHECK SUM ERROR	Checksum error occurred in the mass storage system.
NVM R/W ERROR	Non-volatile IC memory errors. Attempt to save or recall a waveform or a setting. If error message persists, contact a Tektronix Field Service Representative. The 370A can still be used, although internal non-volatile memory functions cannot be used.

Table A-3
Messages (continued)

Message	Description
FD DATA EMPTY	Floppy disk has no data in the file specified by Memory index.
DISK FULL	There is no more room to write data on the disk.
FD NOT READY	Disk drive not ready or floppy disk not installed.
WRITE PROTECT	Floppy disk "write-protected". Set write-protect key to "write enable" position.
FORMAT BUSY	The disk drive is formatting the disk.
FORMAT END	Disk format complete.
FORMAT ABORTED	Disk format is aborted.
INVALID DATA	The data in the file specified by Memory index is not valid.
FORMAT ERROR	Floppy disk system internal error. To determine whether the problem is in the floppy disk or in the disk drive, try a new disk. Attempt to save or recall a waveform or a setting. If the disk drive is at fault, contact a Tektronix Field Service Representative. However, you can still use the 370A, although internal floppy disk functions cannot be used.
FD FAULT	
FD READ ERROR	
FD WRITE ERROR	
FD SEEK ERROR	

Table A-3
Messages (continued)

Message	Description
OUTPUT PROTECT	OUTPUTS are protected by disabling the COLLECTOR SUPPLY, STEP GENERATOR and AUX Supply, if abnormal conditions are detected; such as the COLLECTOR SUPPLY is shorted to either STEP GENERATOR or AUX Supply, or STEP GENERATOR is shorted to AUX Supply, or the oscillation of either STEP GENERATOR or AUX Supply when the oscillation level reaches the detector level. Eliminate abnormal conditions.
OUTPUT RESUMED	OUTPUTS protection is resumed after a time interval. If the abnormal condition continues, the OUTPUT PROTECT message returns.
COPYING CURVES	Characteristic curves are being copied.
COPYING SETUPS	Front-panel setups are being copied.
COPY CANCELED	Copy mode is cancelled.
COPY COMPLETE	Data copying between floppy disk and non-volatile IC memory is completed.