

Agilent 35670A Operator's Guide

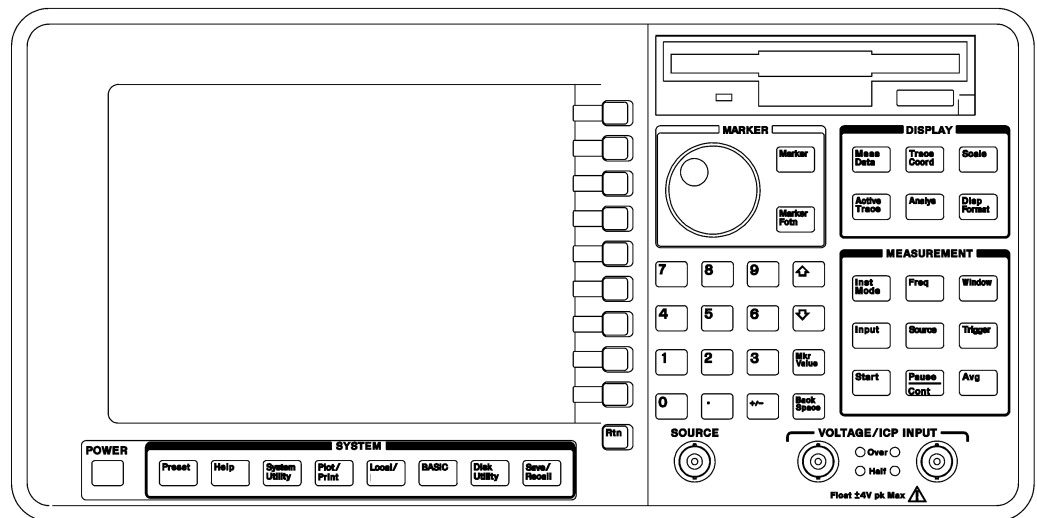

Agilent Part Number: 35670-90053
For instruments with firmware version A.00.00
Printed in Malaysia

Print Date: March 2010
Copyright © Agilent Technologies, Inc, 1992-2010
All rights reserved.

The Agilent 35670A at a Glance (Front Panel)

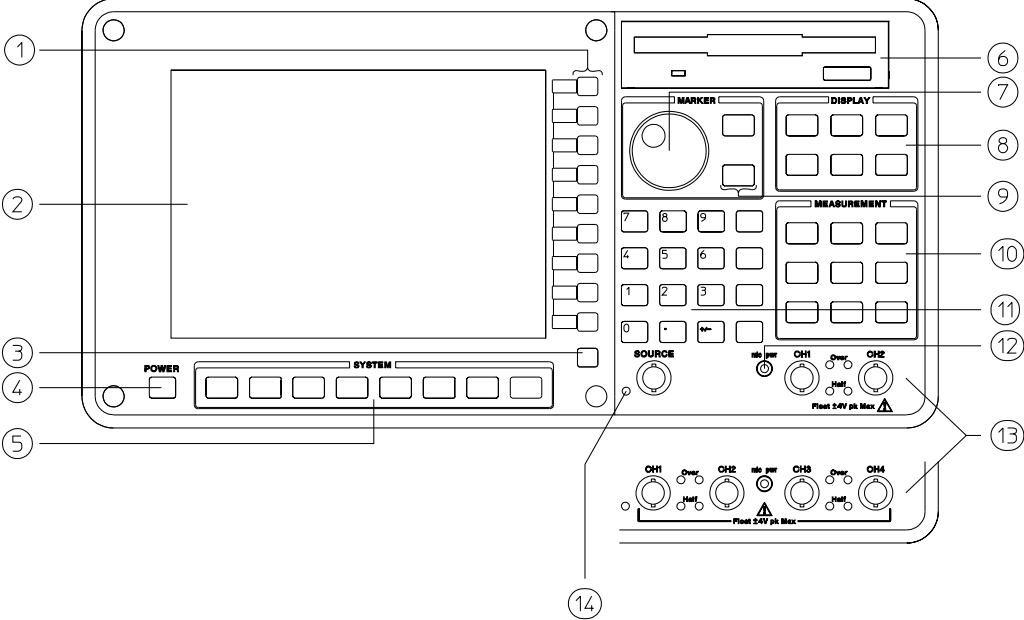

Agilent 35670A Front Panel

1-Use the softkeys to select items from the current menu. A softkey's function is indicated by a video label on the analyzer's screen. Throughout this book, softkeys are printed like this: [FFT ANALYSIS].

Hardkeys are front-panel buttons whose functions are always the same. They have a label printed directly on the key itself. Throughout this book, hardkeys are printed like this: [**Inst Mode**].

2-The analyzer's screen is divided into the menu area and the display area. The menu area displays video labels for the softkeys. The data area displays measurement data and information about the parameter settings.

3-The [**Rtn**] key returns the menu to the previous level.

4 -The POWER switch turns on the analyzer.

5 -Use the SYSTEM keys to control various system-level functions. These functions include saving files, plotting measurement data, and accessing online help.

6 -Use the disk drive to save your work on 3.5 inch flexible disks.

7-The knob moves the markers and the cursor. It also steps through numeric values and scrolls through online help.

8 -Use the DISPLAY keys to control what appears on the analyzer's traces. They only affect how data is displayed; DISPLAY keys do not change measurement parameters. *You can press keys in the DISPLAY menus without losing measurement parameters.*

9 -Use the MARKER keys to select a variety of marker features.

10-Use the MEASUREMENT keys to control the analyzer's source and inputs. They also control measurement parameters. *You must make a new measurement if you change a MEASUREMENT parameter.*

11-Use the numeric-entry keys to enter a numeric value.

12-The microphone power connector provides power (8 Vdc) for the Microphone Adapter Kit (Option UK4).

13-The connector area of the front panel has two different configurations. The standard analyzer has a source output connector and two input connectors. The 4-channel analyzer (Option AY6) has four input connectors.

Range indicators are located next to each input connector. The upper LED is the over-range indicator (the signal level exceeds the current range setting). The lower LED is the half range indicator (the signal level exceeds half the current range setting).

14-A source on/off indicator is located at the left edge of the connector area.

The standard Agilent 35670A (2-channel) has a source connector on the front panel.

The Agilent 35670A at a Glance (Rear Panel)

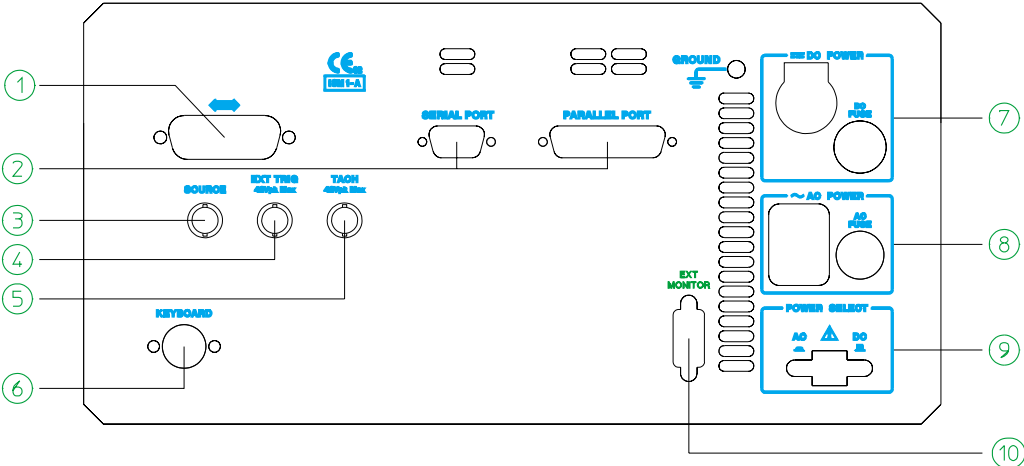

Agilent 35670A Rear Panel

1-The GPIB connector links the Agilent 35670A to other GPIB devices. GPIB parameters are set in the [**Local/GPIB**] and [**Plot/Print**] menus.

2-The SERIAL PORT and the PARALLEL PORT link the analyzer to plotters and printers. These parameters are set in the [Plot/Print] menu.

3-The SOURCE connector outputs the analyzer's source signal. An LED on the front panel indicates if the source is on or off. The source parameters are set in the [**Source**] menu.

The standard Agilent 35670A (2-channel) also has a source connector on the front panel.

4-The EXT TRIG connector links the analyzer to an external trigger signal. The external trigger parameters are set in the [**Trigger**] menu.

5-The TACH connector links the analyzer to a tachometer. The tachometer parameters are set in the [**Input**] menu.

6-The KEYBOARD connector attaches an optional keyboard to the analyzer.

7-The DC POWER connector accepts DC power levels from 12 - 28 Vdc (nominal).

8-The AC POWER connector accept a wide range of ac voltage levels.

9-The POWER SELECT switch determines whether the analyzer is powered via the AC POWER connector or the DC POWER connector.

10-The EXT MONITOR port links the analyzer to multi-sync monitors.

Safety Summary

The following general safety precautions must be observed during all phases of operation of this instrument. Failure to comply with these precautions or with specific warnings elsewhere in this manual violates safety standards of design, manufacture, and intended use of the instrument. Agilent Technologies, Inc. assumes no liability for the customer's failure to comply with these requirements.

GENERAL

This product is a Safety Class 1 instrument (provided with a protective earth terminal). The protective features of this product may be impaired if it is used in a manner not specified in the operation instructions.

All Light Emitting Diodes (LEDs) used in this product are Class 1 LEDs as per IEC 60825-1.

ENVIRONMENTAL CONDITIONS

This instrument is intended for indoor use in an installation category II, pollution degree 2 environment. It is designed to operate at a maximum relative humidity of 95% and at altitudes of up to 4600 meters. Refer to the specifications tables for the ac mains voltage requirements and ambient operating temperature range.

BEFORE APPLYING POWER

Verify that the product is set to match the available line voltage, the correct fuse is installed, and all safety precautions are taken. Note the instrument's external markings described under Safety Symbols.

GROUND THE INSTRUMENT

To minimize shock hazard, the instrument chassis and cover must be connected to an electrical protective earth ground. The instrument must be connected to the ac power mains through a grounded power cable, with the ground wire firmly connected to an electrical ground (safety ground) at the power outlet. Any interruption of the protective (grounding) conductor or disconnection of the protective earth terminal will cause a potential shock hazard that could result in personal injury.

FUSES

Only fuses with the required rated current, voltage, and specified type (normal blow, time delay, etc.) should be used. Do not use repaired fuses or short-circuited fuse holders. To do so could cause a shock or fire hazard.

DO NOT OPERATE IN AN EXPLOSIVE ATMOSPHERE

Do not operate the instrument in the presence of flammable gases or fumes.

DO NOT REMOVE THE INSTRUMENT COVER

Operating personnel must not remove instrument covers. Component replacement and internal adjustments must be made only by qualified service personnel.

Instruments that appear damaged or defective should be made inoperative and secured against unintended operation until they can be repaired by qualified service personnel.

WARNING

The WARNING sign denotes a hazard. It calls attention to a procedure, practice, or the like, which, if not correctly performed or adhered to, could result in personal injury. Do not proceed beyond a WARNING sign until the indicated conditions are fully understood and met.

Caution

The CAUTION sign denotes a hazard. It calls attention to an operating procedure, or the like, which, if not correctly performed or adhered to, could result in damage to or destruction of part or all of the product. Do not proceed beyond a CAUTION sign until the indicated conditions are fully understood and met.

Safety Symbols



Warning, risk of electric shock



Caution, refer to accompanying documents



Alternating current



Both direct and alternating current



Earth (ground) terminal



Protective earth (ground) terminal



Frame or chassis terminal



Terminal is at earth potential.



Standby (supply). Units with this symbol are not completely disconnected from ac mains when this switch is off

Regulatory Markings





 N10149	<p>The C-tick mark is a registered trademark of the Spectrum Management Agency of Australia. This signifies compliance with the Australian EMC Framework regulations under the terms of the Radio Communications Act of 1992.</p>
 <p>ICES/NMB-001 ISM GRP.1 CLASS A</p>	<p>The CE mark is a registered trademark of the European Community.</p> <p>ICES/NMB-001 indicates that this ISM device complies with the Canadian ICES-001.</p> <p>Cet appareil ISM est conforme a la norme NMB-001 du Canada.</p>
	<p>Contains one or more of the six hazardous substances above the maximum concentration value (MCV), 40 Year EPUP.</p>
 <p>C 206349 US</p>	<p>The CSA mark is a registered trademark of the CSA-International.</p>
	<p>This instrument complies with the WEEE Directive (2002/96/EC) marketing requirement. The affixed product label indicates that you must not discard this electrical/electronic product in domestic household waste.</p>

Table of Contents

Part I Making Measurements

Setting Up a Measurement Part I-1

1 Measuring Rotating Machinery

- To connect transducers 1-2
- To specify a transducer's unit and sensitivity 1-3
- To calibrate a transducer 1-4
- To measure vibration power 1-6
- To characterize a tachometer signal 1-8
- To measure an order spectrum 1-10
- To display an rpm-stepped order map 1-12
- To display a time-stepped order map 1-13
- To measure an order track 1-14
- To display an rpm-stepped order track 1-16
- To display a time-stepped order track 1-17
- To display phase relative to the tachometer signal 1-18
- To display an rpm profile 1-19
- To display an orbit diagram 1-20

2 Measuring Structures

- Measuring Structures 2-2
- Impact Testing 2-8
- To measure a driving point measurement 2-10
- To view unwrapped phase of a driving point measurement 2-12
- To view the real and imaginary components of a driving point measurement 2-13
- To preview the time record 2-14

3 Measuring Sound

- To connect the microphone adapter (Option UK4) 3-2
- To connect microphones 3-3
- To calibrate a microphone 3-4
- To measure sound pressure level 3-6
- To measure overall sound pressure level 3-8
- To measure overall impulse characteristics 3-9

4 Measuring Spectra and Networks

- To measure a wideband spectrum 4-2
- To measure a narrowband spectrum 4-4
- To measure frequency and amplitude 4-5
- To measure noise power (PSD) 4-6
- To measure harmonic distortion 4-7
- To measure sideband power 4-8
- To display a spectral map 4-9
- To measure frequency response—FFT 4-10
- To measure frequency response—swept sine 4-12
- To measure phase distortion 4-14

5 Measuring Control Systems

- Measuring Control Systems 5-2
- Measuring Control System Performance 5-6
- To measure a step response 5-8
- To measure performance parameters 5-10
- Measuring Control System Stability 5-12
- To measure an open loop response 5-14
- To measure gain and phase margin 5-16
- To display a Nyquist diagram. 5-17
- To measure a closed loop response 5-18
- To calculate the open loop response 5-20

6 The Arbitrary Source Option 1D4

- The Arbitrary Source 6-2
- To create a step signal 6-4
- To create a ramp signal 6-6
- To create a profiled chirp waveform 6-8

7 Using Time Capture

- To prepare for filling the capture buffer 7-2
- To allocate memory for the capture buffer 7-4
- To fill the capture buffer 7-5
- To save the capture buffer on a flexible disk 7-6
- To recall a capture buffer from a flexible disk 7-7
- To examine the capture buffer 7-8
- To define an analysis region 7-9
- To prepare for measuring from the capture buffer 7-10
- To measure from the capture buffer 7-12

Part II Working with the Display

8 Displaying Measurement Data

- To select the active trace 8-2
- To display measurement data—one channel, one trace 8-3
- To display measurement data—one channel, multiple traces 8-4
- To display measurement data—multiple channels, multiple traces 8-5
- To display a data register 8-6
- To display a math function 8-7

9 Formatting the Display

- To arrange traces on the screen 9-2
- To enable global screen elements 9-3
- To enable trace-specific screen elements 9-4
- To enter your own trace title 9-5
- To control the screen 9-6
- To set up a waterfall display 9-7
- To enhance a waterfall display 9-8
- To display the waterfall buffer 9-9
- To display one trace from the waterfall buffer 9-10
- To display a slice through the waterfall buffer 9-11

10 Scaling the Display

- To enable Y-axis autoscaling 10-2
- To scale the Y-axis with Reference and Y Per Div softkeys 10-3
- To set top and bottom values for the Y-axis 10-4
- To scale the Y-axis with axes scale markers 10-5
- To match Y-axis scaling of another trace 10-6
- To scale the X-axis with axes scale markers 10-7
- To match X-axis scaling of another trace 10-8

11 Selecting Display Units

- To select a coordinate system 11-2
- To select the frequency/time unit 11-3
- To select the phase unit 11-4
- To select the amplitude unit 11-5
- To specify a transducer's unit and sensitivity 11-6
- To convert a displayed transducer unit 11-7
- To display amplitude in dBm 11-8

Part III Using the Basics

12 Using Online Help

- To display help for a key 12-2
- To display a related help topic 12-3
- To select a topic from the help index 12-4
- To print a help topic 12-5
- To exit the help system 12-6

13 Managing Files and Disks

- To set up an external disk 13-2
- To select the default disk 13-3
- To format a flexible disk 13-4
- To change the current DOS directory 13-5
- To create a DOS directory 13-6
- To save a trace 13-7
- To save a program 13-8
- To save other data 13-9
- To recall a trace 13-10
- To recall a program 13-11
- To recall other data 13-12
- To delete a file 13-13
- To delete a DOS directory 13-14
- To copy a file 13-15
- To rename a file 13-16

14 Plotting and Printing

- To set up your hardcopy device—parallel 14-2
- To set up your hardcopy device—serial 14-3
- To set up your hardcopy device—HP-IB 14-4
- To plot screen contents 14-5
- To print screen contents 14-6
- To annotate a plot or print 14-7
- To reassign plotter pens 14-8
- To modify the plotting speed 14-9
- To position a plot on the page 14-10

Part IV Using Advanced Tools

15 Synthesis Option 1D3

Synthesis 15-2

The Synthesis Table and Data Formats 15-4

To display a synthesis table — Pole-Zero Format 15-15

To select/convert a table format — Pole-Residue format 15-16

To select/convert a table format — Polynomial format 15-17

Creating a Synthesis Table 15-18

To create a synthesis table 15-22

To clear a synthesis table 15-24

Performing the Synthesis 15-25

To synthesize a frequency response curve 15-26

To change the data spacing for the X-axis 15-28

Working With Synthesis Tables 15-29

To edit an existing synthesis table 15-30

To save a synthesis table 15-31

To save a synthesis trace 15-32

To recall a synthesis table 15-33

To transfer a curve fit table to a synthesis table 15-34

To change the synthesis register 15-35

16 Curve Fit

Option 1D3

Curve Fit 16-2

Overview of Curve Fit Procedures 16-27

To set up a curve fit 16-30

To specify a weighting function 16-32

To perform a curve fit 16-33

To set up a curve fit — manual operation 16-34

Working with Curve Fit Tables 16-36

To edit a curve fit table 16-37

To transfer a curve fit table to a synthesis table 16-38

To compare a frequency response measurement to synthesized results 16-39

To save a curve fit table 16-40

To save a curve fit's frequency response function 16-41

To recall a curve fit table 16-42

To change the curve fit register 16-43

17 Limit Testing

- To draw a limit 17-2
- To delete a limit segment 17-3
- To convert a trace to a limit 17-4
- To enable limit testing 17-5
- To save a limit 17-6

18 Math Operations and Data Editing

- Math Operations and Data Editing 18-2
- To define a constant 18-4
- To specify an operand within an operation 18-5
- To define a function 18-7
- To view the results of a math operation 18-8
- To compute cepstrum 18-9
- To compute a Hilbert transform 18-10
- To calculate the envelope of a function 18-11
- To compute the signal-to-noise ratio 18-12
- To compute group delay 18-13
- To modify a waveform 18-14

Setting Up a Measurement

The following seven chapters present a variety of measurements you can make with the Agilent 35670A and its options. Each chapter focuses on a different type of measurement.

- Rotating Machinery Chapter 1
- Structures Chapter 2
- Sound/Acoustics Chapter 3
- Spectra and Networks Chapter 4
- Control Systems Chapter 5

In addition, the last two chapters show you how to use the analyzer's optional arbitrary source (chapter 6) and the analyzer's time capture buffer (chapter 7).

Each measurement follows a basic procedure. Depending upon the measurement, some steps may be eliminated or be revised. Generally, the procedure is as follows:

- 1 Initialize the analyzer.
- 2 Make connections.
- 3 Specify the measurement parameters.
- 4 Specify the triggering and averaging parameters.
- 5 Configure the display.
- 6 Measure the device-under-test (DUT).

In the event that the specific measurement you wish to make is not presented in this book, look for a similar measurement and use the procedure as a guideline. In some cases, the procedure will instruct you to select a preset value. This is done to acquaint you with the menu selections and give you the opportunity to select a different setting.

The following discussion presents an overview of the basic measurement. Detailed information is presented for each step to assist you in making the appropriate selection.

Initialize the analyzer

This step initializes the analyzer to a known state, selects the instrument mode and the number of channels, and measurement data.

Preset

Most measurements begin by presetting the analyzer to a known state. This known state provides a convenient starting point when you are setting up a measurement.

Instrument mode / number of channels

When you specify an instrument mode you are asking the analyzer to acquire input data and process it in a certain way. When equipped with a full complement of options, the Agilent 35670A functions as a spectrum analyzer, network analyzer, acoustic sound level meter, acoustic intensity analyzer, vibration analyzer, audio-frequency oscilloscope and amplitude-domain analyzer.

To use each of these different “instruments,” you can press the **[Inst Mode]** hardkey. Then press the appropriate softkey to select an appropriate instrument mode. The standard Agilent 35670A is equipped with the following instrument modes:

- FFT Analysis
- Correlation Analysis
- Histogram/Time

Additionally, your Agilent 35670A may be equipped with the following optional instrument modes.

- Octave Analysis
- Order Analysis
- Swept Sine

Some measurement features are unavailable with certain instrument modes. (An inactive softkey appears “ghosted.”) Softkey menus change depending on the instrument mode you have selected. The preset instrument mode is FFT analysis.

The **[Inst Mode]** menu allows you to select the number of channels for your measurement. The preset selection is a two-channel measurement, set for Channel 1 and Channel 2.

The instrument mode and the number of channels affects the way the analyzer collects input data. (In fact, *all* the hardkeys in the front panel's Measurement Group affect the way the analyzer collects input data.) If you change something with any of these keys, the analyzer must retake a measurement.

Measurement data

Each of the six instrument modes has its own set of available measurement data. When you select a type of measurement data, you are instructing the analyzer to display a particular piece of the measurement data that has already been acquired. Measurement data is selected with the **[Meas Data]** hardkey which is part of the front panel's Display group. If you press a key in this group, all you are doing is selecting which type of data you want to display—you are not changing the way the analyzer makes measurements.

The following table shows the measurement data available with each instrument mode. For more information about this measurement data, see online help.

Measurement data available with each instrument mode

	FFT analysis	Octave Analysis	Order Analysis	Swept Sine	Correlation Analysis	Histogram /Time
Power Spec CH1/2/3/4	yes [*]	yes [*]	yes [*]			
Linear Spec CH1/2/3/4	yes [*]			yes [*]		
Time Channel 1/2/3/4	yes [*]		yes [*]	yes [*]	yes [*]	yes ^{‡*}
Windowed Time Chan 1/2/3/4	yes [*]				yes [*]	
Frequency Response 2/1	yes			yes		
Frequency Response 3/1	yes [*]			yes [*]		
Frequency Response 4/1	yes [*]			yes [*]		
Frequency Response 4/3	yes [*]			yes [*]		
Coherence 2/1	yes [†]					
Coherence 3/1	yes ^{*†}					
Coherence 4/1	yes ^{*†}					
Coherence 4/3	yes ^{*†}					
Cross Spectrum 2/1	yes			yes		
Cross Spectrum 3/1	yes [*]			yes [*]		
Cross Spectrum 4/1	yes [*]			yes [*]		
Cross Spectrum 4/3	yes [*]			yes [*]		
Orbit 2/1	yes		yes			
Orbit 3/1	yes [*]		yes [*]			
Orbit 4/1	yes [*]		yes [*]			
Orbit 4/3	yes [*]		yes [*]			

* Channels 3 and 4 available only with Agilent 35670A Option AY6

† Available only when averaging is turned on

‡ In Histogram/Time mode, time data is called "unfiltered time" data

Measurement data available with each instrument mode (continued)

	FFT analysis	Octave Analysis	Order Analysis	Swept Sine	Correlation Analysis	Histogram
Math Function	yes	yes	yes	yes	yes	yes
Data Register	yes §	yes §	yes §	yes §	yes §	yes §
Waterfall Register	yes	yes	yes	yes	yes	yes
Capture CH1/2/3/4	yes *	yes *	yes *	yes *	yes *	yes *
Composite Power CH1/2/3/4			yes *!			
Order Track CH1/2/3/4			yes *!			
RPM Profile			yes			
Normalized Variance CH1/2/3/4				yes *		
Auto Correlation CH1/2/3/4					yes *	
Cross Correlation 2/1					yes	
Cross Correlation 3/1					yes *	
Cross Correlation 4/1					yes *	
Cross Correlation 4/3					yes *	
Histogram CH1/2/3/4						yes *
PDF† CH1/2/3/4						yes *
CDF‡ CH1/2/3/4						yes *

* Channels 3 and 4 available only with Agilent 35670A Option AY6

† Probability Density Function

‡ Cumulative Density Function

§ Data registers are unique in that they allow you to transport data from one instrument mode to another

! Available only when Track is ON in the **[Freq]** menu.

Connect the device-under-test/signal source

Each task illustrates the measurement setup. In most cases, the standard two-channel Agilent 35670A is used in the illustration. If you are using a four-channel analyzer (Option AY6), the source connector is located on the rear panel. (The two-channel analyzer has a source connector on both the front and rear panels.)

Set measurement parameters

Measurement parameters affect the way the analyzer takes input data. Most of these selections are grouped under a set of hardkeys in the front panel's Measurement Group. If you change a parameter under one of these menus you need to take new data.

Specifying frequency data

The Agilent 35670A has a default resolution of 400 lines (401 points, or bins)—and you can specify 800, 200, or 100 lines of display resolution. However, for a given display resolution, narrower spans have finer frequency resolution. This is because the same number of display points represents a smaller range of frequencies.

Full-span measurements let you view the entire frequency spectrum on one display. With the Agilent 35670A, the spectrum can extend from 0 Hz to 102.4 kHz for one-channel measurements, up to 51.2 kHz for two-channel measurements, and 25.6 kHz for four-channel measurements. This provides a frequency resolution, at full-span and 400 lines of resolution, of 256 Hz, 128 Hz, and 64 Hz respectively.

Alternatively, you may wish to view smaller slices of the frequency spectrum. You can select any number of different spans and position these spans where you want by specifying their start or center frequencies. You can also select different spans by specifying a center frequency and a span width. This process of viewing smaller spans is sometimes called “zooming” or “band-selectable analysis.”

Measurements with spans that start at 0 Hz are often called *baseband* measurements. Those with spans that start at frequencies other than 0 Hz are often called *zoomed* measurements.

Frequency Resolution

The frequency resolution of an FFT analyzer is usually stated in number of lines. The most common offerings are 400 and 800 lines, although some analyzers—such as the Agilent 35670A—offer variable resolution. A 400-line FFT analyzer, set up to display a 4 kHz span, would have a frequency resolution of 4000 Hz per 400 lines—10 Hz per line. The length of the time record determines how long a given measurement will take and the maximum frequency that you can measure.

For example, an 800-line analyzer measuring a 1 kHz span requires a 0.8 second time record. A 3200-line analyzer measuring the same 1 kHz span requires a 3.2-second time record. This relationship is

independent of processing speed. The smaller the span, the longer the time record required.

You can easily make calculations to determine values for four inter-related functions; maximum frequency, time-record length, frequency resolution, and frequency span:

- Maximum frequency = $(N/2) \times (1/\text{time-record length})$, where N=number of samples
- Time record length = number of lines/frequency span
- Frequency resolution = $1/\text{time-record length}$
- Frequency span = (frequency resolution \times FFT lines)

Configuring the inputs

The standard Agilent 35670A has two input connectors on the front panel. Option AY6 has four input connectors on the front panel. Each input channel is single-ended and has an input impedance of 1 Megohm, shunted by a capacitance of less than 100 pF. When the analyzer is in 1-channel mode, only one input is connected, in 2-channel mode, two inputs are connected, and in 4-channel mode, all four inputs are connected.

Here are some of the different ways to configure each input channel:

- grounded/floating input
- coupling ac/dc
- anti-alias filter on/off
- autoranging on/off
- A-weight filter on/off
- ICP power supply on/off

You can also specify transducer units from the input menu. Transducer units are useful when making measurements with calibrated transducers such as microphones or accelerometers.

In addition, the Agilent 35670A also has a *tachometer input* and an *external trigger* input. Both of these connectors are on the rear panel.

Input range

The analyzer has 40 input ranges, from -51 dBVrms to $+27$ dBVrms in 2 dB increments. You can set the input range manually, or you can use the analyzer's autoranging feature. If autoranging is on, the analyzer automatically selects a less-sensitive range if the signal exceeds the current input range. To make the best measurement possible, you should carefully consider the method you use to set the input range—setting the range manually or using autorange.

Maximum Input Range (+27dBVrms) and its maximum values in equivalent units

dBVrms	dBV(peak)	Vrms	V(peak)
+27 dBVrms	+30.01 dBV(peak)	+22.39 Vrms	+31.66 V(peak)

Minimum Input Range (-51dBVrms) and its minimum values in equivalent units

dBVrms	dBV(peak)	Vrms	V(peak)
-51 dBVrms	-47.99 dBV(peak)	+2.818 mVrms	+3.986 mV(peak)

Input overload

The overload status indicators are located next to each input connector. There is also an *OVERLOAD* status message that may appear at the *bottom* of the analyzer's display.

If an input channel is currently overloaded the indicator lights up. The status message appears if an input channel is overloaded and the analyzer is unable to change to a less-sensitive range. This occurs if you exceed the analyzer's maximum input range (+27 dBv). If you turn off autorange, the *OVERLOAD* message appears anytime you exceed the current input range.

The analyzer's response to an overload condition varies. If autoranging is on, an overload condition simply causes the analyzer to change to a less-sensitive input range—unless the maximum input range is already selected. If you are making an averaged measurement and an overload occurs, the analyzer begins a new series of averages.

In some cases, the *OVERLOAD* message remains on the display even when there is no longer an overload condition. This lets you know that an overload condition has affected a measurement in progress. Consider this example: you are making an averaged measurement using a fixed input range. At some point during the measurement, an overload occurs. Because the analyzer does not autorange and restart the measurement (because autoranging is off), the message remains to let you know that an overload conditions has corrupted the averaged data.

Caution

Although the analyzer's input has protection circuitry, signals greater than the following (referenced to ground) may damage the analyzer:

- ± 42 volts (peak) applied to the center conductor of the input connector.
- ± 4 volts (peak) applied to the shell of the input connector (in float mode).

Input overload detection is sensitive to broadband signals—this means that the analyzer senses overload conditions even if the over-range frequency component is outside the analyzer's current frequency span. Thus the overload status indicators or the *OVERLOAD* status message may appear even if you are viewing a frequency span with no over-range components.

Autorangeing

When autorangeing is on, the analyzer continuously monitors the amplitude of the input signals and, if necessary, automatically changes the input range. If the input signal increases enough to exceed the current input range, the analyzer changes to a less-sensitive input range. When autorangeing occurs, the analyzer displays the _____ message. If you are making an averaged measurement and autorangeing occurs, the analyzer begins a new series of averages.

You can set the input range manually when you want to maintain a specific input range setting. Ideally, the signal peak should fall in the upper half of the currently-selected input range.

If you set the input range too low (more sensitive than necessary), the analyzer's input circuitry will introduce distortion into the measurement. But if you set the input range too high (less sensitive than necessary), the resulting loss of dynamic range will introduce additional noise—in some cases, the increase in the noise floor may even obscure low-level frequency components.

If you use a fixed input range, there is approximately 2 dB of headroom at the top of each range before the input channel distorts. So if you are using a fixed input range, an overload condition does not occur unless you exceed this level. This is important to know, particularly for rotating machinery measurements where transient signals often exceed the desired input range.

Configuring the source

The analyzer's source can supply a number of different waveforms. For example, you can select any of the following waveforms with the FFT Analysis mode (keep in mind that not all source waveforms are available with each instrument mode):

- random noise
- burst random
- periodic chirp
- burst chirp
- pink noise
- fixed sine
- arbitrary source (optional)

Source impedance

The analyzer's source impedance is very low (less than 5 ohms) and is designed to be operated into nearly any type of load. If your device-under-test required a specific source impedance, be sure to place an appropriate resistor in series with the analyzer's source output. For example, if your device-under-test requires a source impedance of approximately 600 ohms, you can insert a 590 ohm resistor in series with the analyzer's source output.

Caution

Although the analyzer's source has protection circuitry, do not apply more than ± 42 volts (peak) to the center conductor of the source connector (referenced to ground).

Source Waveforms available with each instrument mode

	FFT analysis	Octave Analysis	Order Analysis	Swept Sine	Correlation Analysis	Histogram/Time
Random Noise	yes	yes	yes		yes	yes
Burst Random	yes				yes	yes
Periodic Chirp	yes				yes	yes
Burst Chirp	yes				yes	yes
Pink Noise	yes	yes	yes		yes	yes
Fixed Sine	yes	yes	yes		yes	yes
Arbitrary Source	yes [*]				yes [*]	yes [*]
Swept Sine				yes [‡]		

* Available only with Option 1D4

‡ Available only with Option 1D2

Selecting a windowing function

A window is a time-domain weighting function applied to the input signal. A window is a filter used to remove signals that are not periodic (and therefore spurious) within the input time record. Depending on the window, the analyzer attenuates certain parts of the input time record, to prevent leakage—a smearing of energy across the frequency spectrum—caused by transforming signals that are not periodic within the time record.

The Agilent 35670A has several window types available. Each window offers particular advantages. Because each window type produces different measurement results (just how different depends on the characteristics of the input signal and how you trigger on it), you should carefully select a window type appropriate for the measurement you are trying to make.

To learn about the analyzer's windowing function, see online help or Agilent Technologies, Inc. Application Note 243 (available from your local Agilent Sales/Service Office). Additional information is also available in the accessory Agilent 35288, *DSA Concept Documentation*.

Specify the triggering and averaging parameters

Triggering tells the analyzer to begin collecting data. For some measurements, averaging lets you discriminate between random events (noise, for example) and components that are actually part of the signal you want to characterize.

Triggering

Starting a measurement is a three-state process. The first stage is pressing the [**Start**] key, the second stage is arming the measurement, and the third stage is triggering.

Arming merely enables the analyzer to respond to a trigger. Triggering tells the analyzer to begin collecting data. Both arming and triggering can be automatic or subject to specified conditions. If you specify automatic arming and free run triggering, the analyzer begins collecting data as soon as you press the [Start] key.

The Agilent 35670A has several different types of triggering. You can select a particular trigger to ensure that the analyzer samples input data at an appropriate time—for example, to synchronize a measurement with an external device. Not all trigger types are available with every instrument mode.

The trigger types available include the following:

- Free Run Trigger. The analyzer collects data continuously, without waiting for a trigger signal.
- External Trigger. The analyzer triggers when the specified trigger conditions are met at the external trigger input on the rear panel.
- Channel Trigger. The analyzer triggers when the trigger conditions are met at the specified channel's input connector.
- Source Trigger. The analyzer triggers from the internal source.
- GPIB Trigger. The analyzer triggers when it receives an appropriate GPIB command.

The following table lists the trigger types available for each instrument mode. For detailed information on specific trigger types, see online help.

Instrument Mode						
Trigger Type	FFT analysis	Octave Analysis	Order Analysis	Swept Sine	Correlation Analysis	Histogram/Time
Free Run	yes	yes	yes		yes	yes
External	yes	yes	yes		yes	yes
Channel 1	yes				yes	yes
Channel 2	yes				yes	yes
Channel 3	yes*				yes*	yes*
Channel 4	yes*				yes*	yes*
Source	yes				yes	yes
GPIB	yes	yes			yes	yes

* Available only with Agilent 35670A Option AY6

Delay You can use a pre- or post-trigger delay to make the analyzer trigger before or after the trigger signal. You can monitor the effect of the delay by viewing time channel data (or windowed time channel data).

To set a pre-trigger delay, you specify a negative value (as in -10 msec). To set a post-trigger, you specify a positive (as in 10 msec). The default trigger delay is 0.

The amount of trigger delay possible varies with the width of the current frequency span. This is because the smaller the frequency span, the longer the time record. With multiple input channels, the difference between the delay specified for the “earliest” channel and the delay specified for the “latest” channel is dependent upon the frequency resolution as shown in the table below. For more information, see online help.

Resolution (lines)	Maximum Delay Difference (samples)	Maximum Delay Difference (time records)
800	6144	3
400	7168	7
200	7680	15
100	7936	31

To accomplish a post-trigger delay, the analyzer holds off a measurement until the specified delay time has elapsed. Pre-trigger delay is more complicated. The analyzer uses a special trigger event buffer that is dedicated to storing seven time records worth of input data. When the trigger occurs, the analyzer goes back into this trigger buffer to obtain input data that is older than the current input data.

Tachometer input There is an input for a tachometer signal on the rear panel of the Agilent 35670A. This accepts a pulse from a tachometer mounted on rotating machinery. The tachometer signal is used to trigger the analyzer during order track measurements.

The tach signal must have a fairly linear region that is stable in amplitude throughout the RPM range that you want to measure. The tach pulse width need not be constant because only the leading (or trailing edge) of the tach signal is used. It is not necessary for the tach signal to have a fast rise-time (sine waves, for example, are acceptable).

Averaging

An average is a series of combined measurement results that incorporates anywhere from 1 to 9,999,999 averages. As the analyzer makes a series of averages, the results from the last completed measurement are combined, point-by-point, with the previous measurement. These combined results are retained and displayed as they are updated.

To increase the speed of averaged measurements, you can select *fast averaging*. For fast averaging, the analyzer does not update the displayed measurement after each average but instead, displays measurement results only after a certain number of averages.

When the analyzer completes a series of averages, you can restart the measurement or you can continue the measurement. If you restart the measurement, the average count goes back to 0 and begins again. If you continue the measurement, the analyzer adds the next series of averages to the results of the previous measurement—for example, if you've taken 25 averages, continuing the measurement (by pressing [Pause-Cont]) adds another 25 averages to make a total of 50 averages for that particular measurement.

Averaging and (and related features) available with each instrument mode

	FFT analysis	Octave Analysis	Order Analysis	Swept Sine	Correlation Analysis	Histogram/ Time
RMS	yes				yes	
RMS Exponential	yes				yes	
Peak Hold	yes	yes *				
Linear		yes				
Exponential		yes				
Equal Confidence		yes				
Time	yes		yes		yes	
Time Exponential	yes		yes		yes	
Fast Average	yes			yes †	yes	yes
Settle Time				yes		
Integrate Time				yes		
Overlap capability	yes				yes	
Repeat capability	yes	yes	yes		yes	yes
Preview capability	yes					
Overload reject	yes				yes	

* Peak Hold in Octave mode is different than in other modes—see online help for explanation

† Fast Averaging in Swept Sine mode is different than in other modes—see online help for explanation

Configuring the display

Once you select both an instrument mode and appropriate measurement data, configuring the display lets you specify how you want to look at the selected measurement data.

Display format

You can use the analyzer's **[Disp Format]** menu to view measurement data in the following formats:

- single
- upper/lower
- front/back
- upper/big lower
- quad
- measurement state
- Bode diagram

Not all display formats are appropriate for all instrument modes. Those formats that are inappropriate for a particular mode are unavailable when that instrument mode is active.

In addition, you can reduce the amount of information on the screen if you use the following display format features:

- grid on off
- blank annotation
- blank display
- trace title
- default title on/off

Trace coordinates

The dB magnitude trace coordinate is the most common way to view measurement data. However, other trace coordinates are also useful and can reveal information not visible from the dB magnitude display. Here is a list of the available trace coordinates:

- linear magnitude
- logarithmic magnitude
- dB magnitude
- phase
- unwrapped phase
- real part
- imaginary part
- Nyquist diagram
- polar diagram
- group delay
- linear or logarithmic X-axis

These trace coordinates are available with most combinations of instrument mode and measurement data. There are, however, some cases where certain trace coordinates do not apply to particular measurements—if this happens, the inappropriate softkey will be “ghosted.” For example, when you select the FFT analysis instrument mode and then select an orbit measurement, all trace coordinates except the [REAL PART] softkey are ghosted.

Scaling the display

The arrow keys and the knob are especially useful in the [Scale] menu, since they let you quickly change the vertical scaling.

Autoscaling Autoscaling lets the analyzer automatically select a vertical scale that best fits the active trace. If autoscaling is left on, the analyzer adjusts the scale, if necessary, each time the display is updated. If you prefer, you can select the scale manually using the other softkeys in the [Scale] menu.

Keep in mind that autoscaling can affect a waterfall display. If the scale changes, the analyzer clears the waterfall display and displays the next traces using the new scale. This affects only the display, not the measurement. The cleared traces are still kept in the waterfall buffer.

Scale references If you do not want to use autoscaling, you can select top, center, or bottom scale reference. The analyzer keeps this reference, regardless of your choice of y-units/division.

For example, if you are viewing frequency response data on the active trace, setting a top reference of 20 dB means that the top of the line in the display graticule is always at +20 dB. If you change the Y per div value, the top of the scale remains at +20 dB and the bottom of the scale changes accordingly.

Input range tracking You can use input range tracking to reference the scale to the input range currently in use. This behavior varies according to the trace coordinate you've selected:

- For linear magnitude traces, the bottom reference always stays at zero. The Y per div is adjusted so the top of the scale is greater than or equal to the current input range.
- For logarithmic magnitude and dB magnitude traces, the top reference always stays at the current input range.
- For real and imaginary traces, the center reference always stays at zero. The Y per div is adjusted so the top of the scale is greater than or equal to the current input range.
- Phase traces do not use input range tracking. Input range tracking is turned off during an autoscale procedure or when you change the Y per div for real, imaginary, or linear magnitude traces.

Input range tracking is not available when you display frequency response, coherence, or math functions.

Adjusting the units / scale division You can adjust the units/scale division by using the [Y PER DIV (DECADES)] softkey. For linear Y-axis, this specifies the number of units per vertical scale division. For a log Y-axis, this specifies the number of decades displayed.

When you select a new scale spacing, the currently active reference (top reference, center reference, or bottom reference) is held the same and the rest of the scale adjusted around this level. By the way, the reference softkey with a box around it is the currently-active reference.

Matching X and Y scales You can use the [MATCH X SCALE] softkey to set the X-axis scale of the inactive trace to the active trace. The [MATCH Y SCALE] softkey is similar, but sets the Y-axis scales to the same scaling.

This lets you easily set both traces to identical X-axis or Y-axis scales. This makes it easier to compare data on both traces, particularly when you have the upper/lower or front/back display formats selected.

Axes scale markers The Agilent 35670A offers a feature called axes scaling. This lets you expand the displayed trace to examine it more closely. Using the axes scale markers, you can:

- Specify X-axis or Y-axis scaling.
- Move markers using the knob or numeric entry keys.
- Return to a full-span display.
- Expand the band identified by the markers to fill the display.
- Specify which of the markers should hold its position and which should move.

It is important to remember that axes scaling only expands the displayed data—it does not give you better measurement resolution. If you need more resolution to interpret a measurement, either increase the display resolution or reduce the analyzer's frequency span—then make another measurement.

To learn more about the axes scale markers, see online help.

Measure the device-under-test / signal source

To begin a measurement press the [Start] key. [Start] clears all measurement data from the analyzer's buffers.

The [Pause-Cont] key stops the analyzer in the middle of a measurement. The analyzer displays the measurement as completed so far. Press [Pause-Cont] once more to continue the measurement—the analyzer begins where it left off. [Pause-Cont] does *not* clear the analyzer's buffers.

1

Measuring Rotating Machinery

This chapter shows you how to connect and calibrate transducers. It also shows you how to make several typical rotating machinery measurements. Most of these measurements are made using the analyzer's order analysis mode—available only if your analyzer is equipped with Option 1D0.

To connect transducers

- 1 Press [**Input**] [ALL CHANNELS] [FRONT END CH* SETUP].
- 2 If you are using ICP transducers, press [ICP SUPPLY ON OFF] to highlight ON.
or
If you are using other types of transducers, press [ICP SUPPLY ON OFF] to highlight OFF.
- 3 Connect the transducer output cables to the analyzer's input channels, as shown in the illustration.

You may also want to ac-couple an input channel if the corresponding transducer produces a significant amount of dc offset. Selecting ac-coupling prevents the dc overloads that can occur as you increase the channel's sensitivity. You can select ac-coupling by pressing [COUPLING AC DC]—located under [FRONT END CH* SETUP]—to highlight AC. (The analyzer does this automatically when you turn on a channel's ICP power supply.)

If you preset the analyzer all ICP power supplies will be turned off and all channels will be set to dc-coupling. As a result, you may need to repeat some parts of this task after a preset.

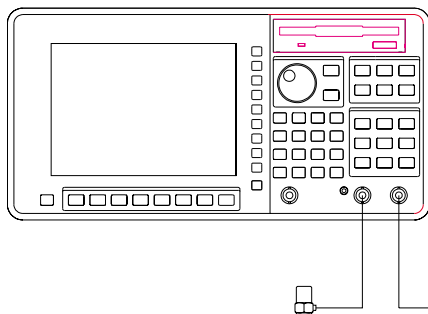

Option AY6

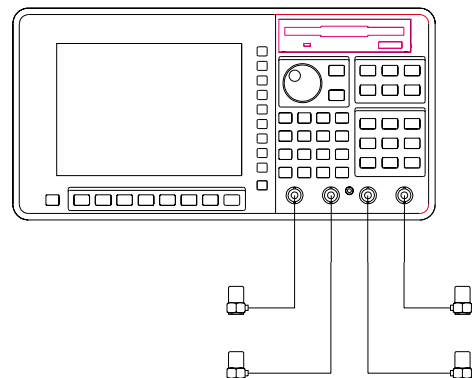

To specify a transducer's unit and sensitivity

- 1 Connect your transducers as described in the preceding task.
- 2 Press [**Input**], then press [CHANNEL 1 2] (or [CHANNEL 1 2 3 4]) to highlight the channel connected to the transducer.
- 3 Press [XDCR UNIT CH_x SETUP] [XDCR UNIT LABEL]. (You can also press [MORE CHOICES] to display additional units.)
- 4 If one of the displayed menus includes your transducer's input unit, press the corresponding softkey.
or
If neither menu includes your transducer's input unit, you can enter the unit yourself (from the [MORE CHOICES] menu): press [USER LABEL] [USER UNIT LABEL] [CLEAR ENTRY], then type a label and press [ENTER].
- 5 Press [**Input**] [XDCR UNIT CH_x SETUP] [XDCR SENSITVITY] <number> <unit>.
- 6 If you want the new unit and sensitivity factored into displayed amplitudes, press [XDCR UNIT ON OFF] to highlight ON.

The Agilent 35670A allows you to measure mechanical devices with a transducer. The transducer must produce an output voltage that's proportional to some input energy over the range of frequencies measured. The unit you specify in this task is the one that's used to quantify the input energy. The sensitivity you enter is the nominal sensitivity (or calibration factor) of the transducer. The unit and sensitivity settings are *not* lost when you preset or turn off the analyzer. Their use is disabled, however, because [XDCR UNIT ON OFF] is set to OFF.

There is an advantage to directly selecting your transducer's input unit instead of entering a user unit label in step 3. If you select one of the acceleration, velocity, or displacement units, you will be able to quickly convert displayed amplitudes from one of these units to another. For more information, see "To convert a displayed transducer unit" in chapter 11.

You can enter transducer sensitivity in V/EU, EU/V, or dB referenced to 1 V/EU. (EU is an abbreviation for engineering units—an alternate name for transducer units.) If you have a calibrator available, you may prefer to calibrate your transducers instead of entering their nominal sensitivities. The next task shows you how to calibrate a transducer.

To calibrate a transducer

This task uses a calibrator, the FFT instrument mode, and the [CAL VALUE AT MARKER] softkey to calibrate a transducer. If you don't have a calibrator, you should enter the nominal transducer sensitivity as described in the previous task.

1 Initialize the analyzer.

Press [**Preset**] [DO PRESET].

Press [**Inst Mode**] [FFT ANALYSIS].

Press [CHANNELS 1 2] (or [CHANNELS 1 2 4]) to highlight the number of channels you want activated.

Press [**Meas Data**], then press [CHANNEL 1 2] (or [CHANNEL 1 2 3 4]) to highlight the channel whose transducer you will calibrate.

Press [PWR SPEC CHANNEL x].

2 Match the active trace's display unit to the calibrator's output unit.

Press [**Input**], then press [CHANNEL 1 2] (or [CHANNEL 1 2 3 4]) to highlight the channel whose transducer you will calibrate.

Press [XDCR UNIT CH_x SETUP] [XDCR UNIT LABEL], then press the softkey corresponding to your calibrator's output unit. (Additional units are displayed when you press [MORE CHOICES].)

Press [**Input**] [XDCR UNIT CH_x SETUP], then press [XDCR UNIT ON OFF] to highlight ON.

Press [**Trace Coord**] [Y UNITS] [EU].

Press [AMPLITUDE PK PP RMS] to highlight one of the following: PK if your calibrator's output amplitude is specified as a peak value, PP if it is specified as a peak-to-peak value, or RMS if it is specified as a root-mean-square value.

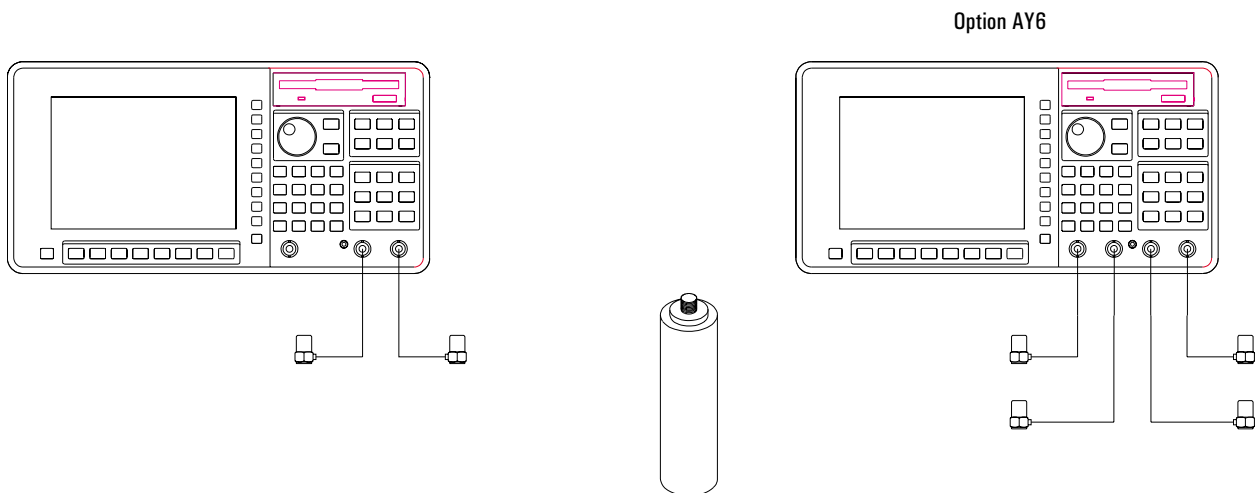

- 3 Connect the transducer's output cable to the analyzer as described at the beginning of this chapter, then secure the transducer to the calibrator.
- 4 Specify the measurement parameters.
Press [**Freq**] [SPAN], then press the down-arrow key if you want to reduce the frequency span.
Press [**Window**] [FLAT TOP] to maximize amplitude accuracy.
- 5 Press [**Scale**], then press [AUTOSCALE ON OFF] to highlight ON.
- 6 Turn on the calibrator, then press [**Start**].
- 7 After the display has been updated at least once, move the marker to the calibrator's output frequency and enter calibrator's output amplitude.
Press [**Marker**] [MARKER TO PEAK].
Press [**Input**] [XDCR UNIT CH_x SETUP] [CAL VALUE AT MARKER], then type the calibrator's specified output amplitude and press [ENTER].

The analyzer uses the number you enter in [CAL VALUE AT MKR] to calculate a new value for [XDCR SENSITVITY]. This new value is the calibration factor that ensures the accuracy of your transducer measurements. The analyzer automatically stores this value and the [XDCR UNIT LABEL] value in nonvolatile memory, so they will not be lost at preset or power-down. However, the values will be used only when [XDCR UNIT ON OFF] is set to ON.

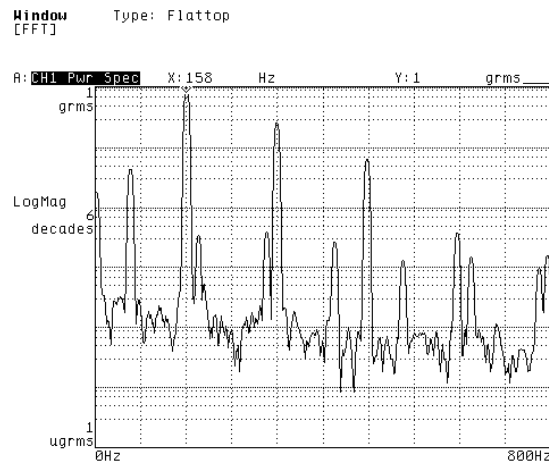

Y-axis readout matches calibration amplitude after you complete this task.

To measure vibration power

This task shows you how to use your calibrated transducers to measure vibration power. Although many vibration measurements are made using the order instrument mode, this task uses the FFT mode so you will *not* need to provide a tachometer signal. (All order-mode measurements require a tachometer signal.)

1 Initialize the analyzer.

Complete the preceding task, “To calibrate a transducer.”

Press [**Active Trace**], then press [A] if you are measuring with one transducer, [A B] if you are measuring with two, or [A B C D] if you are measuring with three or four.

Press [**Meas Data**] [ALL CHANNELS] [PWR SPEC CHANNEL *] to assign one transducer's output to each trace.

2 Secure each calibrated transducer to the device-under-test (DUT).

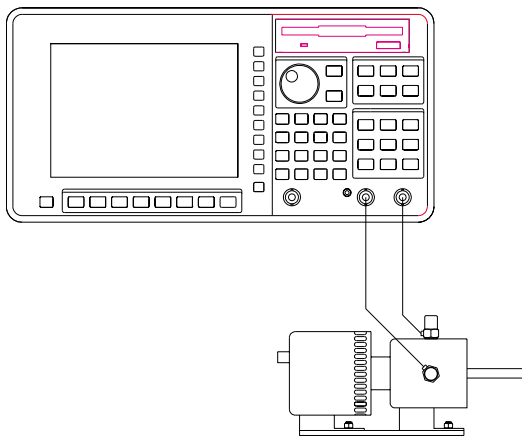

Option AY6

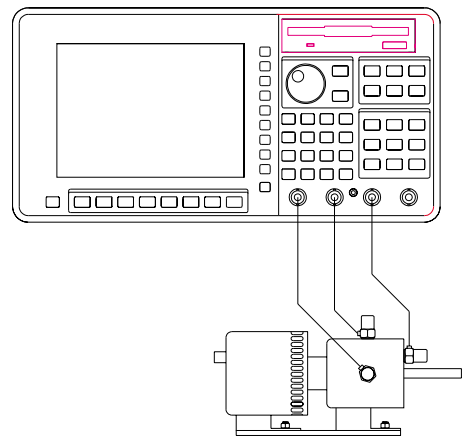

3 Specify the measurement parameters.

Press [**Freq**] [START] <number> <unit>, then press [STOP] <number> <unit> to select the range of frequencies you want to measure.

Press [**Input**] [ALL CHANNELS] [CH* AUTO UP ONLY].

4 Configure the display.

If you prefer to display frequency values in CPM rather than Hz, press [**Trace Coord**] [X UNITS] [CPM (SEC)].

Press [**Scale**], then press [AUTOSCALE ON OFF] to highlight ON.

5 Turn on the DUT, then press [**Start**].

The analyzer also allows you to display successive spectra in a map (or waterfall). To do this, complete the following steps:

Activate the traces you want to view as a map.

Press [**Scale**], then press [AUTOSCALE ON OFF] to highlight OFF.

Press [**Disp Format**] [WATERFALL SETUP], then press [WATERFALL ON OFF] to highlight ON.

For more information on controlling and analyzing waterfall displays, see chapter 9, "Formatting the Display."

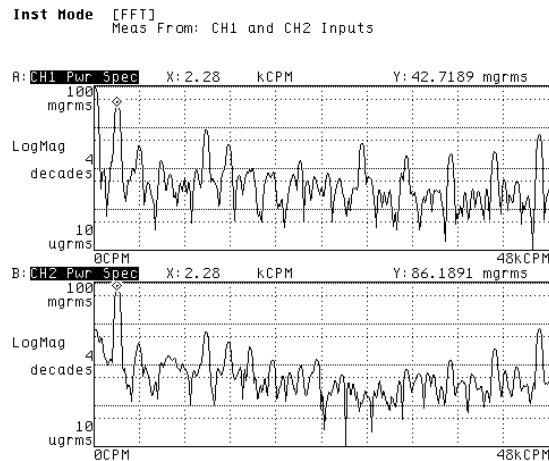

To characterize a tachometer signal

Many rotating machinery measurements are only possible if you supply a tachometer signal. This task helps you characterize a tachometer signal so you can properly set up the parameters for the analyzer's TACH connector.

1 Initialize the analyzer.

Press **[Preset]** [DO PRESET].
Press **[Inst Mode]** [HISTOGRAM/TIME].
Press **[Meas Data]** [UNFILTERED TIME CH 1].

2 Connect the tachometer signal to the CH 1 connector on the analyzer's front panel, and to the TACH connector on its rear panel.

3 Press **[Scale]**, then press [AUTOSCALE ON OFF] to highlight ON.

4 Specify the measurement parameters.

Press **[Freq]** [RECORD LENGTH].
Press the up-arrow hardkey until there are several tachometer pulses on the display.
Press **[Pause-Cont]** to pause the measurement.

5 Use the marker to measure waveform amplitudes.

Press **[Marker]** [MARKER TO PEAK] to place the marker on the waveform's high point, then turn the knob to place it on the low point.
Note each point's Y-axis readout (for use in the next step).

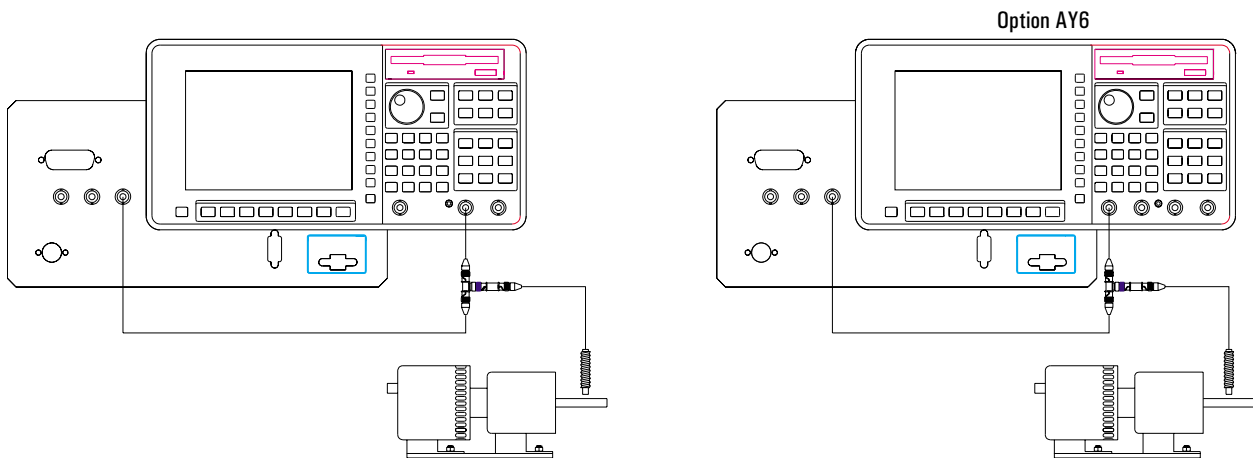

6 Specify the tachometer parameters.

Press [**Input**] [TACHOMETR SETUP].

If the waveform's high or low points fall outside a +/- 4 V range, press [TRG RANGE +/- 20 4] to highlight 20.

Press [LEVEL] <number> <unit> to specify the level at which you want the analyzer to detect the tachometer signal.

If you want the analyzer to detect the falling (negative) edge of the waveform, press [SLOPE POS NEG] to highlight NEG.

Press [TACH PULS PER REV] <number> [ENTER] to specify the number of tachometer pulses produced for each revolution of the device-under-test (DUT).

7 Verify the tachometer setup.

Press [TACH DATA ON OFF] to highlight ON.

Check to be sure that the tachometer readout—located at the top of the display—is stable.

You should specify a level and slope at which the tachometer signal is fairly “clean”—that is, a given pulse of the signal should pass through the specified level in the specified direction only once. If this is not possible, you can use [HOLDOFF TIME] to force the analyzer to ignore multiple passes through the same level. Enter a value that is just long enough to ensure that the analyzer ignores multiple passes through the same trigger level on a given pulse of the tachometer signal.

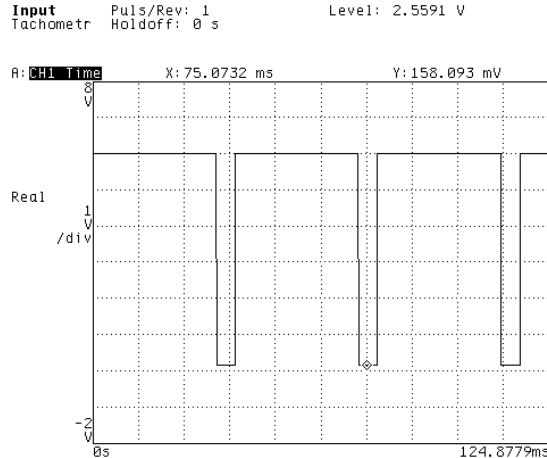

To measure an order spectrum

This task shows you how to use calibrated transducers to measure order spectra. Order-mode measurements are possible only if your analyzer is equipped with Option 1D0.

1 Initialize the analyzer.

Press [**Preset**] [DO PRESET].

Set up your tachometer parameters, as described in “To characterize a tachometer signal,” but ignore that task’s instruction to preset the analyzer.

Calibrate your transducers, as described in “To calibrate a transducer,” but ignore that task’s instruction to preset the analyzer.

Press [**Inst Mode**] [ORDER ANALYSIS].

Press [CHANNELS 1 2] (or [CHANNELS 1 2 4]) to highlight the number of channels you want activated.

Press [**Active Trace**], then press [A] if you are measuring with one transducer, [A B] if you are measuring with two, or [A B C D] if you are measuring with three or four.

Press [**Meas Data**] [ALL CHANNELS] [PWR SPEC CHANNEL *].

2 Secure each calibrated transducer to the device-under-test (DUT).

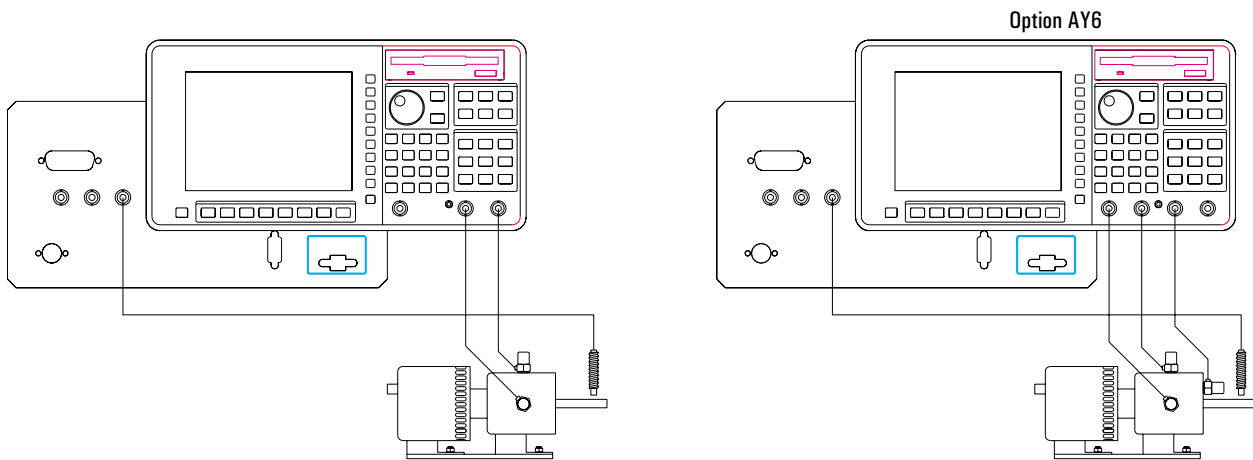

3 Specify the measurement parameters.

Press [**Freq**] [MAX ORDER] <number> [ORDERS] to specify the maximum number of orders you want to measure.

Press [MIN RPM] <number> [RPM], then press [MAX RPM] <number> [RPM] to specify the range of frequencies over which you will measure.

Press [DELTA ORDER] <number> [ORDERS] to specify the resolution of your X-axis. Press [**Input**].

For each active channel, press [CHANNEL 1 2] (or [CHANNEL 1 2 3 4]) to highlight its channel number, then press [CHANNEL x RANGE] <number> <unit>.

4 Press [**Scale**], then press [AUTOSCALE ON OFF] to highlight OFF and press it again to highlight ON.

5 Turn on the DUT, then press [**Start**].

Input channels do not autorange when an order mode measurement is running. As a result, you must set ranges carefully to ensure that they are *not* exceeded during the measurement. You can use one of the following methods:

- Manually set each channel's range to a value that slightly exceeds the maximum signal level you anticipate. Step 3 tells you how to set the range manually.
- Pause the measurement, then select up-only autoranging for all channels while the DUT is running. To do this, press [**Pause-Cont**], then press [**Input**] [ALL CHANNELS] [CH* AUTO UP ONLY]. (After the channels have autoranged, you may want to select [CH* FIXED RANGE] to prevent spurious signals from increasing the range setting.)

If an input signal does exceed the range of the corresponding channel, an OVLD message is displayed at the bottom of all affected traces. You should select a higher range for the overloaded channel before you restart the measurement.

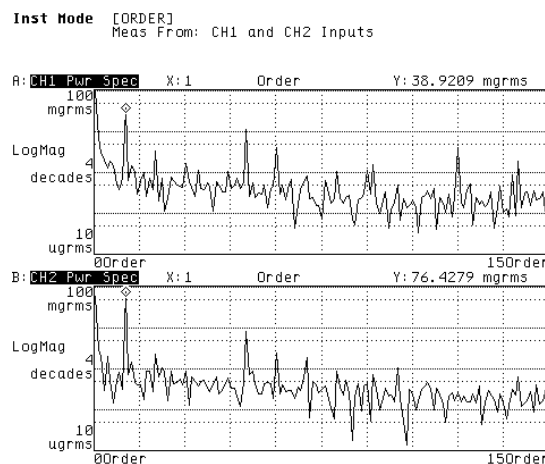

To display an rpm-stepped order map

- 1 Complete the task, “To measure an order spectrum.”
- 2 Press [**Trigger**] [ARM SETUP] [RPM STEP ARM].
- 3 Press [START RPM USAGE], then press one of the following: [RPM INCREASING] for a runup measurement, or [RPM DECREASING] for a rundown measurement.
- 4 Press [**Rtn**] [RPM STEP SIZE] <number> [RPM] to specify how often the analyzer should add a new measurement to the map.
- 5 Activate all traces you want to view as a map, then press [**Scale**] [AUTOSCALE ON OFF] to highlight OFF.
- 6 Press [**Disp Format**] [WATERFALL SETUP], then press [WATERFALL ON OFF] to highlight ON.
- 7 Turn on the device-under-test (DUT), then press [**Start**].

If you select [RPM INCREASING], the first measurement is armed when the tachometer frequency passes through the value of [MIN RPM] in a positive direction. If you select [RPM DECREASING], the first measurement is armed when the tachometer frequency passes through the value of [MAX RPM] in a negative direction. [MIN RPM] and [MAX RPM] are located under the [**Freq**] hardkey.

Note: The analyzer measures at exact [RPM STEP SIZE] intervals only if [FREE RUN TRIGGER] is selected under the [**Trigger**] hardkey.

For more information on controlling and analyzing waterfall displays, see chapter 9, “Formatting the Display.”

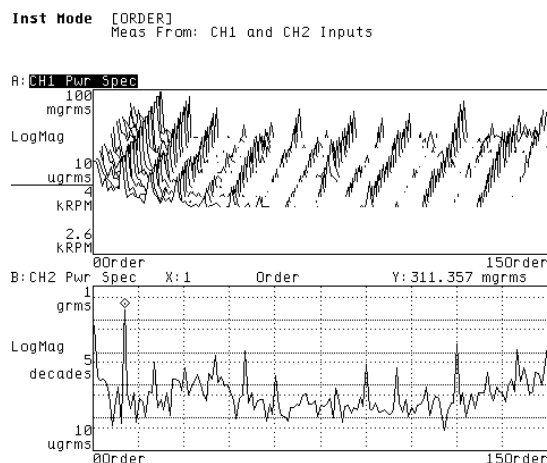

Waterfall skewing was turned on for this display.

To display a time-stepped order map

- 1 Complete the task, “To measure an order spectrum.”
- 2 Press [**Trigger**] [ARM SETUP] [TIME STEP ARM].
- 3 Press [START RPM] <number> [RPM] to specify tachometer frequency at which the first measurement should be armed.
- 4 Press [START RPM USAGE], then press one of the following: [RPM INCREASING] if you want the first measurement to be armed above [START RPM], [RPM DECREASING] if you want it to be armed below [START RPM], or [START RPM OFF] if you want it to be armed as soon as you press the [**Start**] hardkey.
- 5 Press [**Rtn**] [TIME STEP SIZE] <number> [s] to specify how often the analyzer should add a new measurement to the map.
- 6 Activate all traces you want to view as a map, then press [**Scale**] [AUTOSCALE ON OFF] to highlight OFF.
- 7 Press [**Disp Format**] [WATERFALL SETUP], then press [WATERFALL ON OFF] to highlight ON.
- 8 Turn on the device-under-test (DUT), then press [**Start**].

Note: The analyzer measures at exact [TIME STEP SIZE] intervals only if [FREE RUN TRIGGER] is selected under the [**Trigger**] hardkey.

For more information on controlling and analyzing waterfall displays, see chapter 9, “Formatting the Display.”

To measure an order track

This task shows you how to use calibrated transducers to measure order tracks. Before you complete this task, however, you may want to measure order spectra to help you identify the orders you want to track. Both of these order-mode measurements are possible only if your analyzer is equipped with Option 1D0.

1 Initialize the analyzer.

Press [**Preset**] [DO PRESET].

Set up your tachometer parameters, as described in “To characterize a tachometer signal,” but ignore that task’s instruction to preset the analyzer.

Calibrate your transducers, as described in “To calibrate a transducer,” but ignore that task’s instruction to preset the analyzer.

Press [**Inst Mode**] [ORDER ANALYSIS].

Press [CHANNELS 1 2] (or [CHANNELS 1 2 4]) to highlight the number of channels you want activated.

Press [**Freq**], then press [TRACK ON OFF] to highlight ON.

2 Secure each calibrated transducer to the device-under-test (DUT).

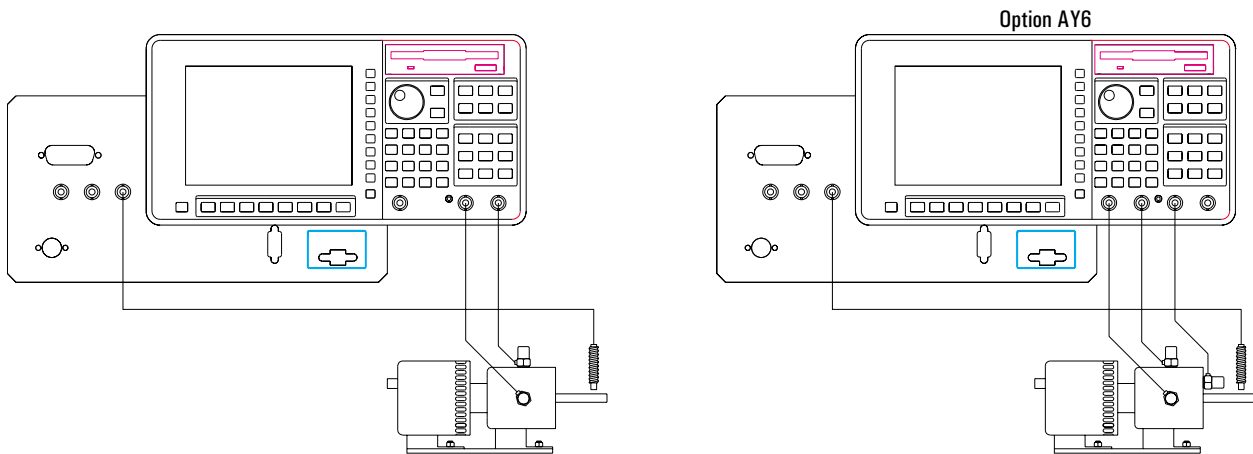

3 Specify the measurement parameters.

Press [**Freq**] [MAX ORDER] <number> [ORDERS] to specify the highest order you want to track.

Press [MIN RPM] <number> [RPM], then press [MAX RPM] <number> [RPM] to specify the range of frequencies over which you will measure.

Press [TRACK POINTS] <number> [ENTER] to specify the number of measurement points in the track.

Press [TRACK SETUP], then use the [TRACK x ORDER] softkeys to specify which orders you want to track.

Press [**Input**].

For each active channel, press [CHANNEL 1 2] (or [CHANNEL 1 2 3 4]) to highlight its channel number, then press [CHANNEL x RANGE] <number> <unit>.

4 Configure the display.

Press [**Active Trace**], then press [A] if you are measuring with one transducer, [A B] if you are measuring with two, or [A B C D] if you are measuring with three or four.

Press [**Meas Data**] [ALL CHANNELS] [MORE CHOICES] [ORDER TRK CHANNEL *], then press the [TRACK x ORD n.nn] softkey corresponding to the track you want to monitor.

Press [**Scale**], then press [AUTOSCALE ON OFF] to highlight ON.

5 Turn on the DUT, then press [**Start**].

If you prefer to look at several tracks from a single channel (or at different tracks from different channels) activate each trace separately in step 4. Then, while a particular trace is activated, you can select the channel and track you want to display in that trace. Finally, you can press [**Disp Format**] [QUAD] to display all four traces at once.

See “To measure an order spectrum” for additional information about setting ranges for your input channels.

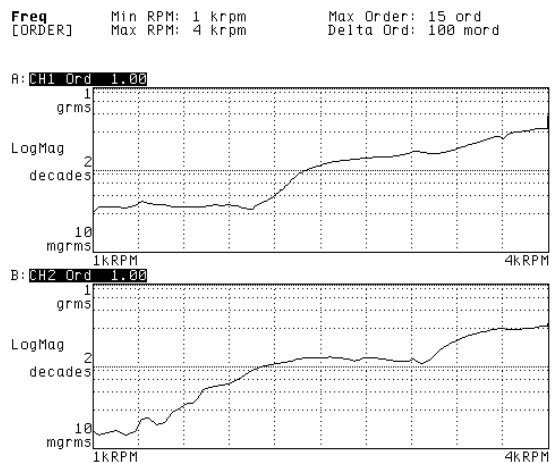

To display an rpm-stepped order track

- 1 Complete the task, “To measure an order track.”
- 2 Press [**Trigger**] [ARM SETUP] [RPM STEP ARM].
- 3 Press [START RPM USAGE], then press one of the following: [RPM INCREASING] for a runup measurement, or [RPM DECREASING] for a rundown measurement.
- 4 Press [**Rtn**] [RPM STEP SIZE] <number> [RPM] to specify how often the analyzer should add a new point to the track.
- 5 Turn on the device-under-test (DUT), then press [**Start**].

If you select [RPM INCREASING], the first measurement point is armed when the tachometer frequency passes through the value of [MIN RPM] in a positive direction. If you select [RPM DECREASING], the first measurement point is armed when the tachometer frequency passes through the value of [MAX RPM] in a negative direction. [MIN RPM] and [MAX RPM] are located under the [**Freq**] hardkey.

Note: The analyzer measures at exact [RPM STEP SIZE] intervals only if [FREE RUN TRIGGER] is selected under the [**Trigger**] hardkey.

For more information on controlling and analyzing waterfall displays, see chapter 9, “Formatting the Display.”

To display a time-stepped order track

- 1 Complete the task, “To measure an order track.”
- 2 Press [**Trigger**] [ARM SETUP] [TIME STEP ARM].
- 3 Press [START RPM] <number> [RPM] to specify tachometer frequency at which the first measurement point should be armed.
- 4 Press [START RPM USAGE], then press one of the following: [RPM INCREASING] if you want the first measurement point to be armed above [START RPM], [RPM DECREASING] if you want it to be armed below [START RPM], or [START RPM OFF] if you want it to be armed as soon as you press the [**Start**] hardkey.
- 5 Press [**Rtn**] [TIME STEP SIZE] <number> [s] to specify how often the analyzer should add a new point to the track.
- 6 Turn on the device-under-test (DUT), then press [**Start**].

Note: The analyzer measures at exact [TIME STEP SIZE] intervals only if [FREE RUN TRIGGER] is selected under the [**Trigger**] hardkey.

For more information on controlling and analyzing waterfall displays, see chapter 9, “Formatting the Display.”

To display phase relative to the tachometer signal

- 1 Complete one of the three preceding order track tasks.
- 2 Connect the tachometer signal to both the TACH and the EXT TRIG connectors.
- 3 Press [**Trigger**] [EXTERNAL TRIGGER].
- 4 Press [TACHOMETR SETUP], then note the settings of [LEVEL] and [SLOPE POS NEG] for use in the next step.
- 5 Press [**Rtn**] [TRIGGER SETUP], then set [USER EXT LEVEL] and [SLOPE POS NEG] to match the corresponding [TACHOMETR SETUP] softkeys.
- 6 Press [EXT RANGE +/- 10 2] to highlight 2 if the tachometer signal falls within a +/- 2 V range, or 10 if it falls outside that range.
- 7 Activate the traces you will use to display phase, then press [**Trace Coord**] [PHASE].
- 8 Turn on the device-under-test (DUT), then press [**Start**].

When you set up an order track measurement as described in this task, the analyzer displays phase data for every channel relative to the tachometer signal. However, this setup provides useful phase information only if the tachometer signal provides one pulse per revolution of the DUT you are measuring.

When you select free run triggering, the analyzer displays phase data for each channel relative to its reference channel. For two-channel Agilent 35670As, channel 1 is the reference for both channels. For four-channel Agilent 35670As, channel 1 is the reference for all channels only when [REF CHANS 1 1,3]—located under the [**Inst Mode**] hardkey—is set to 1. Channel 1 is the reference for 1 and 2, and channel 3 is the reference for 3 and 4 when [REF CHANS 1 1,3] is set to 1,3.

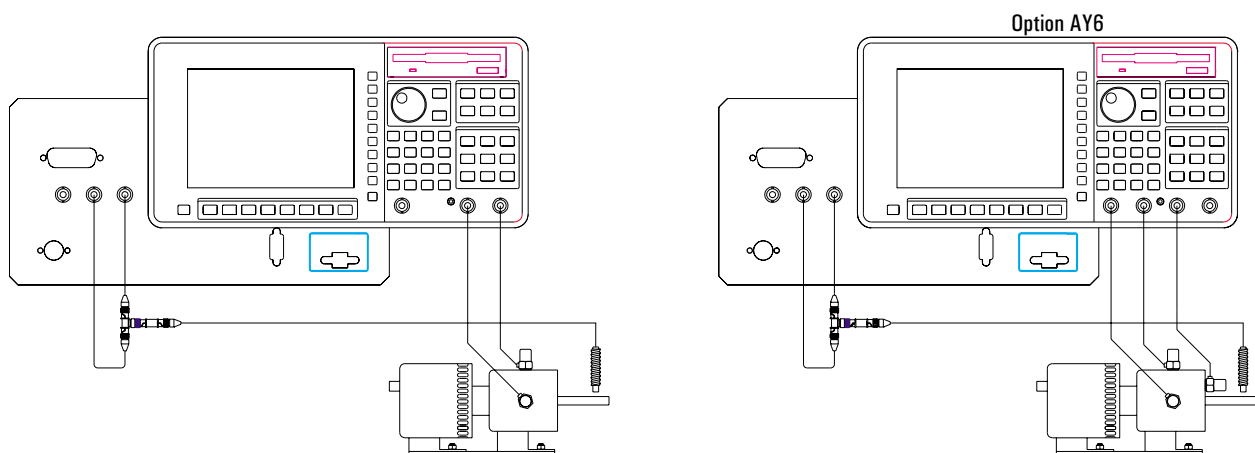

To display an rpm profile

- 1 Complete one of these tasks: “To measure an order spectrum” or “To measure an order track.”
- 2 Press [**Active Trace**], then press [A], [B], [C], or [D] to activate one of the traces.
- 3 Press [**Meas Data**] [MORE CHOICES] [RPM PROFILE].

An rpm profile allows you to monitor changes in the tachometer frequency. Each time the analyzer measures another order spectrum or adds another point to an order track, it also adds another point to the rpm profile. When you are measuring an order spectrum, the total number of points in the profile is equal to the value of [WATERFALL STEPS] (located under [**Disp Format**] [WATERFALL SETUP]). When you are measuring an order track, the total number of points in the profile is equal to the value of [TRACK POINTS] (located under [**Freq**]).

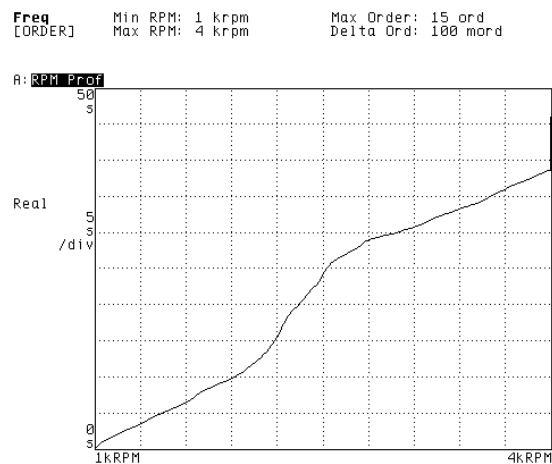

To display an orbit diagram

If you mount two calibrated transducers at 90° to each other, you can use the analyzer to display an orbit diagram. This measurement is possible only if your analyzer is equipped with Option 1D0.

1 Connect the horizontal transducer to channel 1 and the vertical transducer to channel 2.

2 Initialize the analyzer.

Press [**Preset**] [DO PRESET].

Set up your tachometer parameters, as described in “To characterize a tachometer signal,” but ignore that task’s instruction to preset the analyzer.

Calibrate your transducers, as described in “To calibrate a transducer,” but ignore that task’s instruction to preset the analyzer.

Press [**Inst Mode**] [ORDER ANALYSIS].

Press [CHANNELS 1 2] (or [CHANNELS 1 2 4]) to highlight 2.

Press [**Disp Format**] [SINGLE].

Press [**Meas Data**] [ORBIT 2/1].

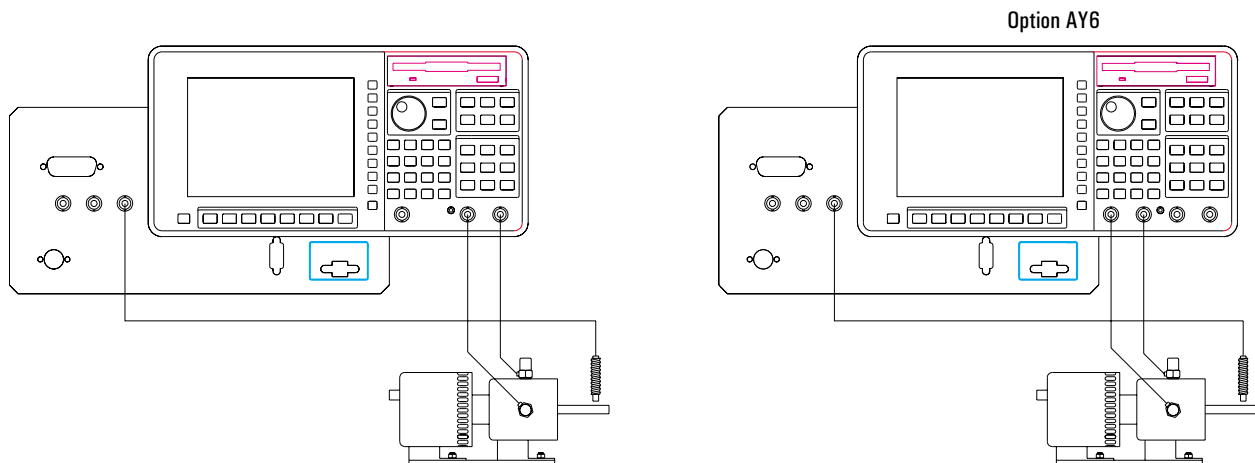

3 Specify the measurement parameters.

Press [**Freq**] [MAX ORDER] <number> [ORDERS] to specify the maximum number of orders you want to measure.

Press [MIN RPM] <number> [RPM], then press [MAX RPM] <number> [RPM] to specify the range of frequencies over which you will measure.

Press [DELTA ORDER] 1 [ORDERS].

Press [**Input**].

For both channels, press [CHANNEL 1 2] (or [CHANNEL 1 2 3 4]) to highlight its channel number, then press [CHANNEL x RANGE] <number> <unit>.

4 Press [**Scale**], then press [AUTOSCALE ON OFF] to highlight ON.

5 Turn on the device-under-test (DUT), then press [**Start**].

With a four-channel Agilent 35670A, you can use four transducers to display two independent orbit diagrams. This allows you to measure two points on the DUT simultaneously. Use channels 1 and 2 to measure one point, and channels 3 and 4 to measure the other (with the horizontal transducers connected to channels 1 and 3). You must modify the last few instructions in step 2, as shown below:

Press [CHANNELS 1 2 4] to highlight 4 (rather than 2), then press [REF CHANS 1 1,3] to highlight 1,3.

Press [**Disp Format**] [UPPER/LOWER].

Activate traces A and B, then press [**Meas Data**] [ALL CHANNELS] [ORBITS */*].

Activate trace B, then press [CHANNEL 1 2 3 4] to highlight 3.

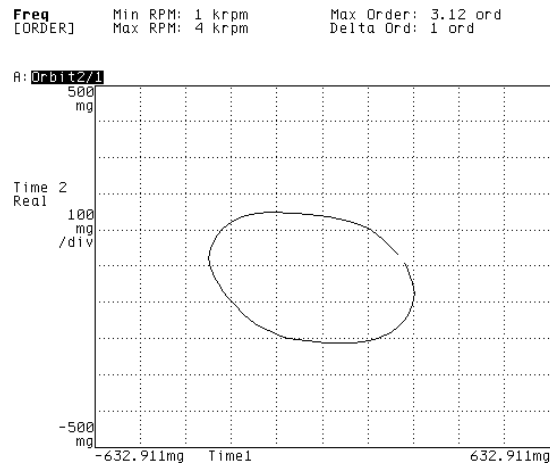

2

Measuring Structures

Measuring Structures

All structures have natural frequencies of resonance. A type of modal testing known as the frequency response function measures the input excitation and output response simultaneously. See figure 2-1.

The method is based on an assumption that the system under-test is linear and stable.

Figure 2-1.

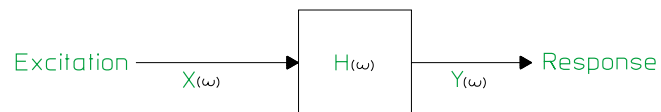

System Block Diagram

This chapter introduces some of the Agilent 35670A's measurement capability for measuring structures. Additional information is available in Agilent 35288, *DSA Concept Documentation* or Agilent Technologies, Inc.'s application note, AN243-3, *The Fundamentals of Modal Testing* (available from your local Agilent Technologies, Inc. Sales/Service Office).

Setting Up Your Test

The basic test set-up required for making frequency response measurements depends upon the type of structure to be tested and the level of results desired. Other factors, including the support fixture and excitation method, affect the amount of hardware needed to perform the test. For making measurements on simple structures, the exciter mechanism can be as basic as an instrumented hammer and requires a minimum amount of hardware. An electrodynamic shaker may be needed to excite a more complicated structure.

The first step in setting up a structure for frequency response measurements is to consider the fixturing mechanisms. This is a key step in the process as it affects the overall structural characteristics. The selection of a fixture goes beyond the scope of this book. Several texts are available that focus on test fixtures. They include:

- *Vibration and Shock Test Fixture Design* by Wayne Tustin and Robert Mercado (Tustin Technological Institute, 1984).
- L. D. Mitchell and K. B. Elliott, "How To Design Stingers for Vibration Testing of Structures," *Sound and Vibration*, April 1984.
- *Modal Testing: Theory and Practice* by Dave J. Ewins (Wiley Interscience, 1984).

The next step in the measurement process involves selecting an excitation function along with an excitation mechanism. The choice of the excitation function dictates the choice of the excitation mechanism. The choice depends on several factors:

- available signal processing equipment
- characteristics of the structure
- general measurement considerations
- the excitation mechanism.

The shaker test and the impact test are the most common excitation mechanisms.

Once an excitation mechanism has been setup to force the structure into motion, you need to select the transducers which sense the force and motion. The piezoelectric transducer is widely used. It is an electromechanical sensor which generates an electrical output when subjected to vibration.

Interpreting Measurement Results

To ensure high quality measurements, it is important to make some trial measurements and examine them before collecting data.

After setting up the structure, you should look at the time domain signals. The input range settings should be set at no more than two times the maximum signal level. This is known as half-ranging. See figure 2-2.

Figure 2-2.

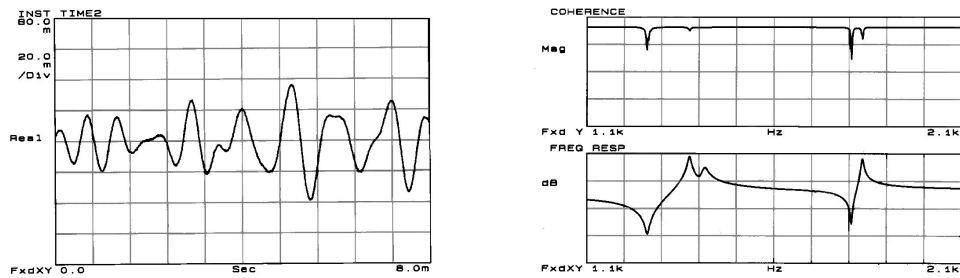

Input Half Ranging

When the response input level is very low relative to the analyzer, noise appears between the peaks in the frequency response. This results in a poor coherence function. See figure 2-3. This is called under-ranging.

Figure 2-3.

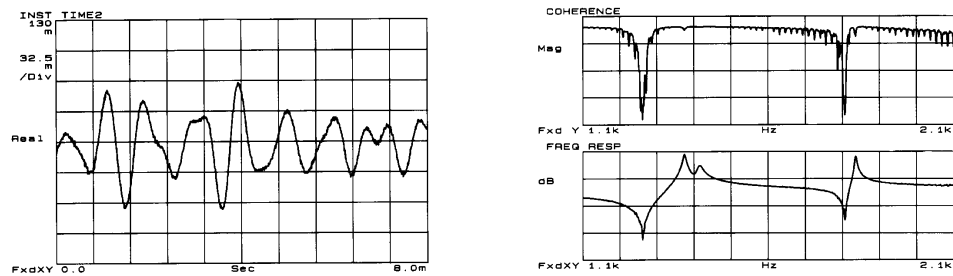

Input Under Ranging

When the response input level is severely overloading, the analyzer's input is clipped. This results in a poor frequency response and poor coherence because the actual response is not being measured. This is called over-ranging. See figure 2-4.

Figure 2-4

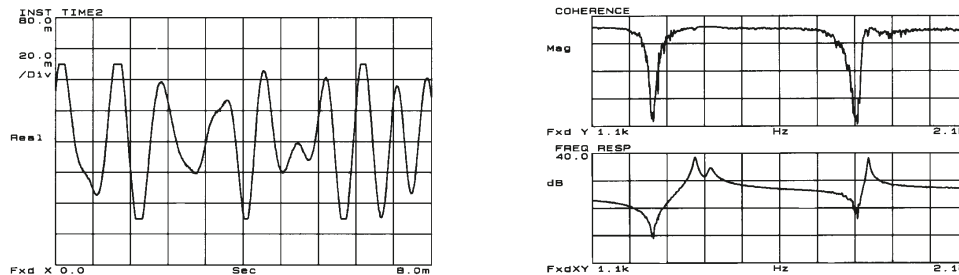

Input Over Ranging

You should also verify that the signals are the type you expect. With a random signal, you should measure the histogram to verify that it has a Gaussian distribution. See figure 2-5. In addition, you can visually inspect transient signals. See figure 2-6.

Figure 2-5.

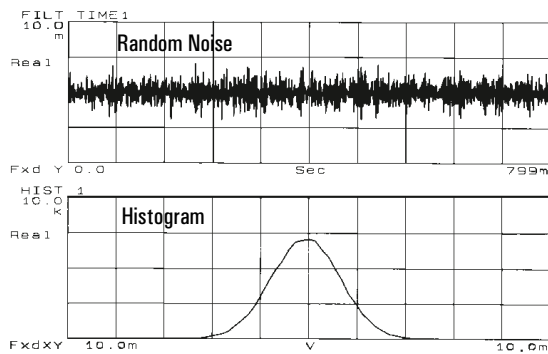

Verify Random Test Signals

Figure 2-6.

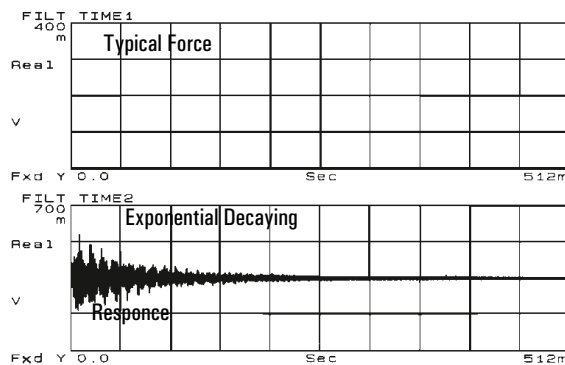

Verify Transient Test Signals

Improving Accuracy

Averaging and windowing are measurement techniques that help to improve the accuracy of a measurement.

Averaging

Use measurement averaging to reduce the statistical variance of a measurement with a random excitation function. Averaging also reduces the effects of nonlinearities.

RMS averaging, which is also called “power” averaging, is calculated by squaring all the values, adding the squares together, dividing by the number of measurements (mean) and taking the square root of the result. RMS averaging is a good technique for determining the average power level. It does not improve the signal-to-noise ratio. RMS averaging only makes a more accurate estimate of the total signal plus noise power.

Linear averaging improves the signal-to-noise ratio of a measurement, but it can only be used if a trigger signal which is synchronous with the periodic part of the spectrum is available. (The periodic part of the input will always be exactly the same in each time record whereas the noise will vary.) Linear averaging is calculated by adding together a series of synchronized triggered measurements and dividing by the number of records. The noise is different in each time record and will tend to average to zero.

Windowing

Use a windowing function to reduce leakage if your signal is not periodic within the time record. (Leakage is the effect of smearing or leaking energy into adjacent frequency lines which results in distorting the spectra.) The effect of leakage underestimates the amplitude of the spectra and overestimates the damping factor.

A windowing function artificially forces the signal to 0 at the beginning and at the end of the time record. The signal then appears to be periodic. A windowing function does not eliminate leakage completely and may distort the results by eliminating some of the data. If possible, another technique is to use a signal that is periodic within the time record, such as burst random or periodic chirp. Such signals eliminate the leakage problem.

Impact Testing

To find natural frequencies, an impulse response measurement can be performed on the structure and the Agilent 35670A can be used to compute the frequency response of the structure. An instrumented hammer impacts the structure and an accelerometer measures the response.

The impact hammer has a load cell that measures the level of force during the impact. In a modal test, impact measurements are made at various places on the structure. The resulting frequency functions can be stored for later analysis by a modal software package.

Impact testing is convenient because it provides shorter measurement times and requires little hardware. However, it can be difficult to implement the test and to produce consistent results. It is difficult to control the velocity of the hammer, so the force level is usually controlled by varying the mass of the hammer. Another disadvantage is that the force spectrum of an impact test cannot be band-limited at lower frequencies when making zoom measurements (starting frequency > 0 Hz) so lower out-of-band modes will be excited.

Choosing a Tip For the Hammer

The frequency content of the energy applied to the structure is a function of the stiffness of the contacting surfaces and the mass of the hammer. It is not feasible to change the stiffness of the test object, therefore, the frequency content is controlled by varying the stiffness of the hammer tip.

The harder the tip the shorter the pulse duration resulting in a higher frequency content.

A rule of thumb is to choose a tip so that the amplitude of the force spectrum is no more than 10 dB to 20 dB down at the maximum frequency of interest.

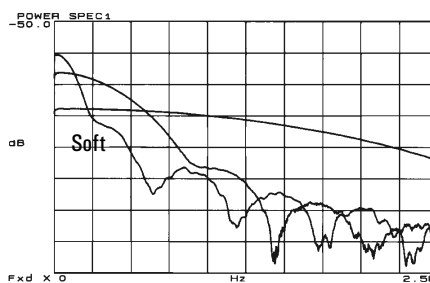
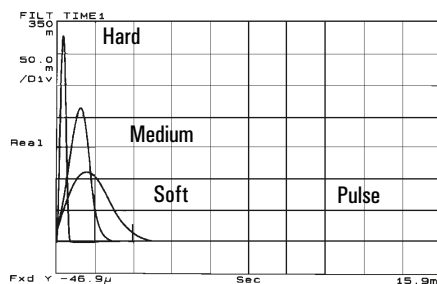

Compensating For Noise and Leakage

Noise can be present in either the force or response signal as a result of a long time record. Leakage can be present in the response signal as a result of a short time record.

Noise may appear after the force pulse. The force window eliminates any noise without affecting the pulse itself.

The response signal is an exponentially decaying function. If the structure is heavily damped, the response may decay out before the end of the time record.

Noise may be present in the remaining part of the time record. If the structure is lightly damped, the response may continue beyond the end of the time record. The effect is leakage.

The exponential window minimizes leakage and can eliminate any remaining noise in the time record. The exponential window uses a time constant which is the time required for the amplitude to be reduced by a factor of $1/e$. A rule of thumb for setting the time constant is approximately $1/4$ the time record length, T .

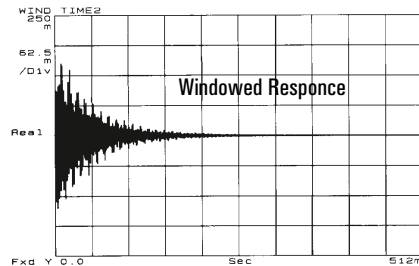
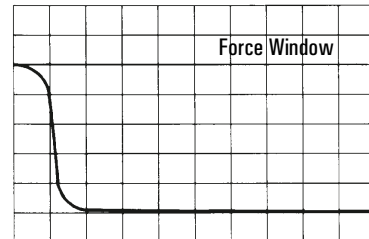
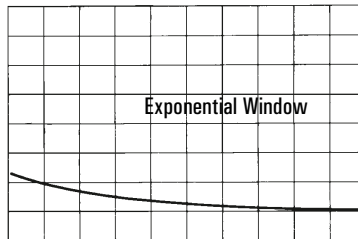
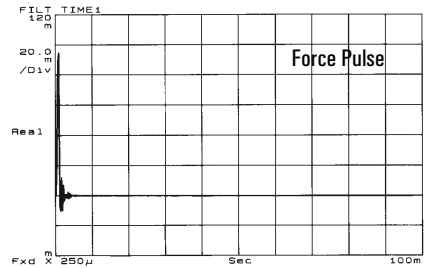
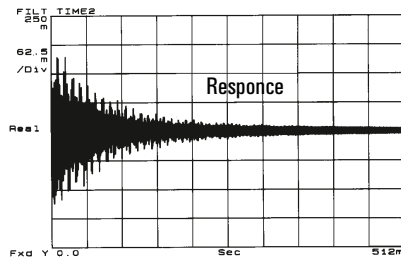

To measure a driving point measurement

A driving point measurement places the response accelerometer at the point where the impact hammer hits the device.

1 Initialize the analyzer.

Press [**Preset**] [DO PRESET].
Press [**Active Trace**] [A B].
Press [**Meas Data**] [FREQ RESP 2/1].

2 Connect the device-under-test (DUT) as shown in the illustration below.

3 Specify the measurement parameters.

Press [**Freq**] [START] <number> <unit>, then press [STOP] <number> <unit>.
Press [**Input**].
Press [CHANNEL 1 2 3 4] to highlight 1.
Press [CHANNEL 1 RANGE] <number> <unit>.
Press [CHANNEL 1 2 3 4] to highlight 2.
Press [CHANNEL 2 RANGE] <number> <unit>.
Press [**Window**] [FORCE EXPO].
Press [FORC EXPO SETUP].
Press [CHANNEL 1 FORC EXPO] to highlight FORC.
Press [FORCE WIDTH] <number> <unit>.
Press [CHANNEL 2 FORC EXPO] to highlight EXPO.
Press [EXPO DECAY] <number> <unit>.

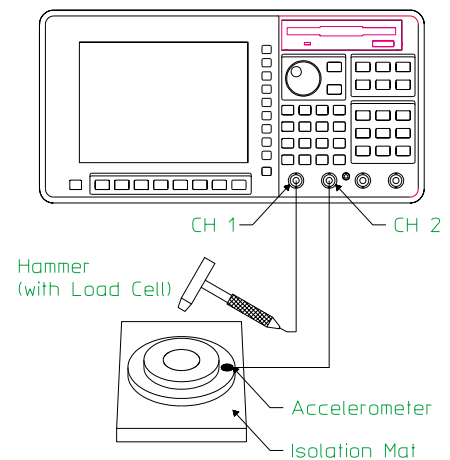
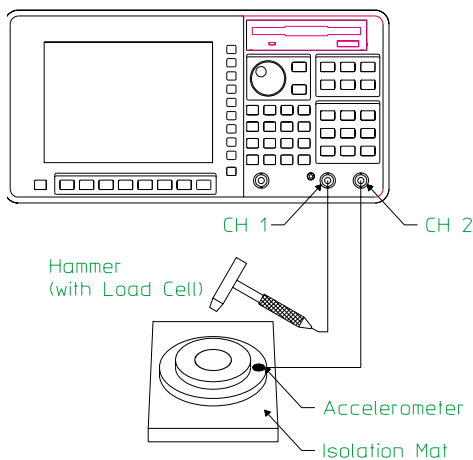

4 Specify the triggering and averaging parameters.

Press [**Trigger**] [CHANNEL 1 2 3 4] to highlight 1.
 Press [TRIGGER SETUP] [CHANNEL LEVEL] <number> [PERCENT %]
 or
 Press <number> <unit>.
 Press [CHANNEL 1 DELAY] [+/-] <number> <unit>.
 Press [CHANNEL 1 2 3 4] to highlight 2.
 Press [CHANNEL 2 DELAY] [+/-] <number> <unit>.
 Press [**Avg**], then press [AVERAGE ON OFF] to highlight ON.

5 Configure the display.

Press [**Trace Coord**] [X-AXIS LIN LOG] to highlight LIN.
 Press [**Active Trace**] [B].
 Press [**Trace Coord**] [PHASE].
 Press [**Active Trace**] [A B].
 Press [**Scale**], then press [AUTOSCALE ON OFF] to highlight ON.

6 Measure the DUT.

Press [**Start**].
 Slowly tap the device 10 times with the impact hammer at or near the accelerometer.

If your hammer taps consistently result in overloads, increase the input ranges in step 3 until overloads no longer occur.

Specifying a trigger delay in step 4 allows you to see the leading edge of the hammer tap.

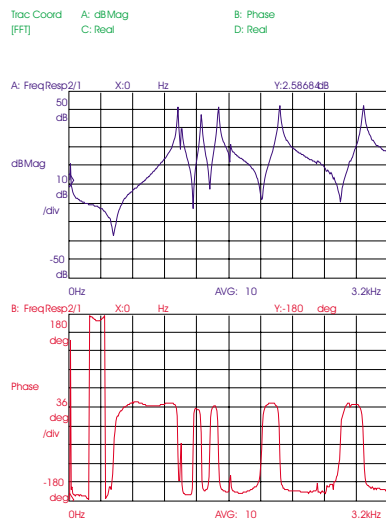

Overload causes distortion in the frequency response.

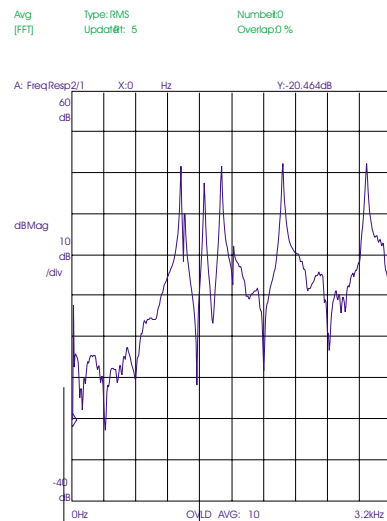

Indicates an overload is included in the average measurement.

To view unwrapped phase of a driving point measurement

- 1 Measure a driving point measurement.
- 2 Press [Active Trace] [B].
Press [Trace Coord] [UNWRAPPED PHASE].
- 3 Press [Scale] [AUTOSCALE ON OFF] to highlight ON.

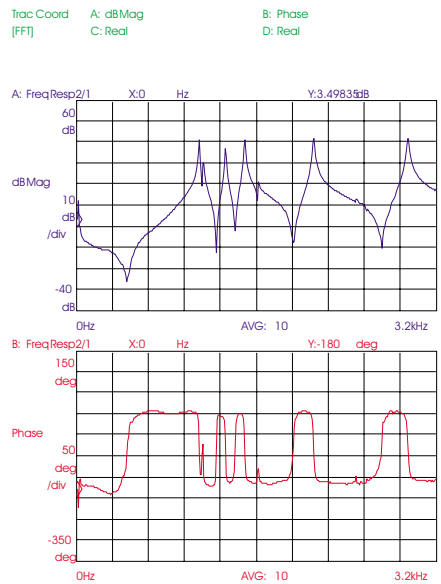

Values indicate
unwrapped phase.

To view the real and imaginary components of a driving point measurement

- 1 Measure a driving point measurement.
- 2 Press [**Active Trace**] [A].
Press [**Trace Coord**] [MORE CHOICES] [REAL PART].
- 3 Press [**Active Trace**] [B].
Press [IMAGINARY PART].
- 4 Press [**Active Trace**] [A B].
Press [**Scale**] [AUTOSCALE ON OFF] to highlight ON.

A characteristic of a driving point measurement is that the imaginary components all point in the same direction. When the imaginary components do not all point in the same direction, it usually indicates that the accelerometer and the impact point for the hammer were separated. In addition, the relative frequencies are the same, but the relative amplitudes at each resonance are different.

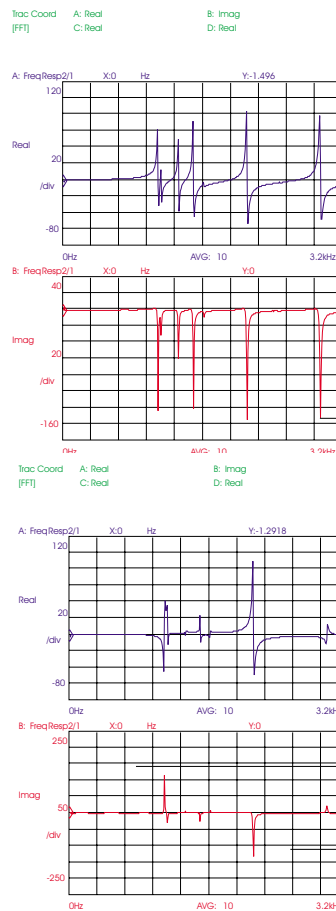

A characteristic of a driving point measurement is that all imaginary components point in the same direction.

When the accelerometer and impact point are separated by 90° , the imaginary components do not point in the same direction.

To preview the time record

The Agilent 35670A's preview lets you examine each time record and decide whether or not to include the data in an averaged measurement. This task performs a driving point measurement with manual preview.

1 Initialize the analyzer.

- Press [**Preset**] [DO PRESET].
- Press [**Meas Data**] [FREQ RESP 2/1].
- Press [**Active Trace**] [B].
- Press [**Meas Data**].
- Press [CHANNEL 1 2 3 4] to highlight 1.
- Press [TIME CHANNEL 1].

2 Connect the device-under-test (DUT) as shown in the illustration below.

3 Specify the measurement parameters.

- Press [**Freq**] [START] <number> <unit>, then press [STOP] <number> <unit>.
- Press [**Input**].
- Press [CHANNEL 1 2 3 4] to highlight 1.
- Press [CH1 FIXED RANGE] <number> <unit>.
- Press [CHANNEL 1 2 3 4] to highlight 2.
- Press [CH2 FIXED RANGE] <number> <unit>.
- Press [**Window**] [FORCE EXPO].
- Press [FORC EXPO SETUP].
- Press [CHANNEL 1 FORC EXPO] to highlight FORC.
- Press [FORCE WIDTH] <number> <unit>.
- Press [CHANNEL 2 FORC EXPO] to highlight EXPO.
- Press [EXPO DECAY] <number> <unit>.

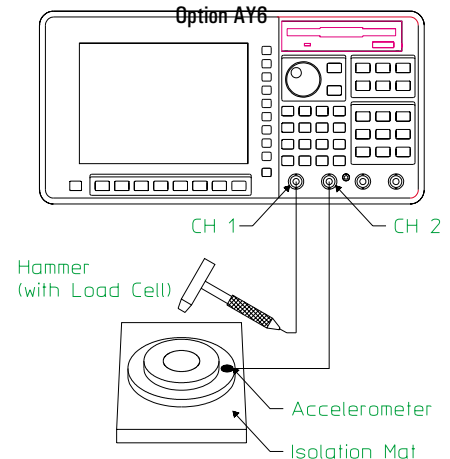
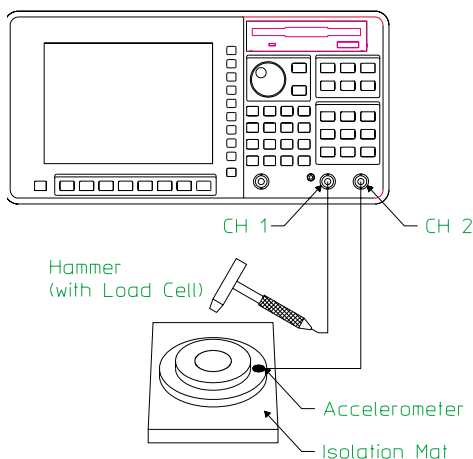

4 Specify the triggering and averaging parameters.

Press [**Trigger**] [CHANNEL 1 2 3 4] to highlight 1.
Press [TRIGGER SETUP] [CHANNEL LEVEL] <number> [PERCENT %].
or
Press <number> <unit>.
Press [CHANNEL 1 DELAY] [+/-] <number> <unit>.
Press [CHANNEL 1 2 3 4] to highlight 2.
Press [CHANNEL 2 DELAY] [+/-] <number> <unit>.
Press [**Avg**], then press [AVERAGE ON OFF] to highlight ON.
Press [AVERAGE PREVIEW] [MANUAL PREVIEW].

5 Configure the display.

Press [Disp Format] [UPPER LOWER].
Press [**Active Trace**] [A].
Press [**Trace Coord**] [DB MAGNITUDE].
Press [**Scale**], then press [AUTOSCALE ON OFF] to highlight ON.
Press [**Avg**] [AVERAGE PREVIEW].

6 Measure the DUT.

Press [**Start**].
Do a hammer tap.
When the message "WAITING FOR ACCEPT/REJECT" appears,
press [ACCEPT TIME REC]
or
press [REJECT TIME REC].

Measuring Structures

If your hammer taps consistently result in overloads, increase the input ranges in step 3 until overloads no longer occur. Specifying a trigger delay in step 4 allows you to see the leading edge of the hammer tap.

When the analyzer receives a trigger, it displays the time record for channel 1 on trace A and the time record for channel 2 on trace B. After you accept the data, the analyzer displays the frequency response on trace A and time channel 1 on trace B.

Analyzer is waiting for a response.

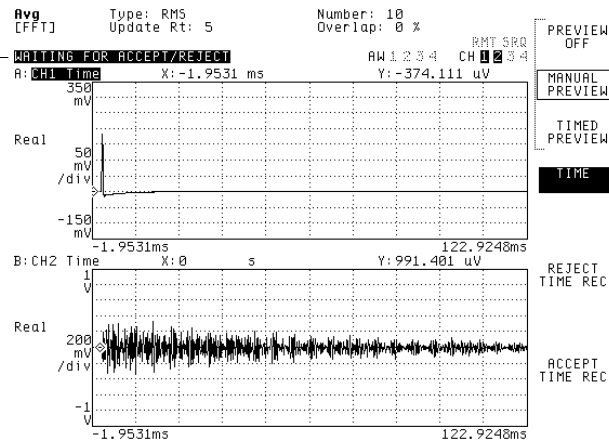

Press this key to accept the measurement.

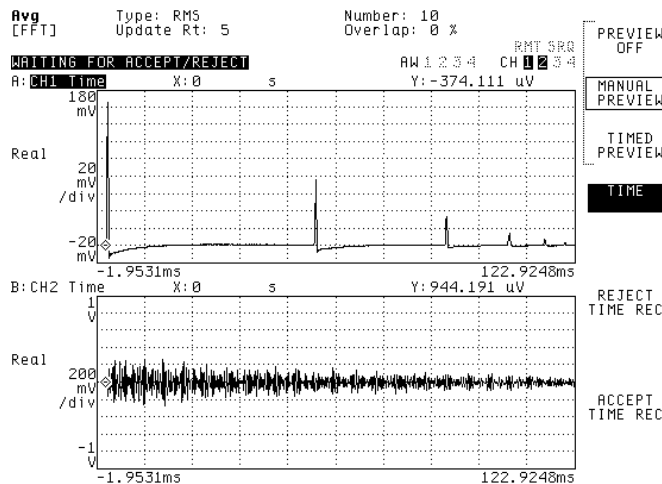

Press this key to reject the measurement.

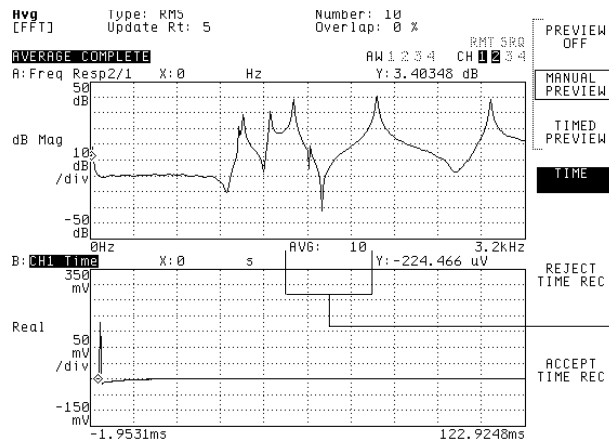

Indicates total number of averages.

When the hammer bounces . . .

Bouncing the hammer during an impact produces a bad measurement. If the measurements are averaged into the modal data during the collection process, the overall modal survey will be in question.

The following traces show the result of a single good hammer tap.

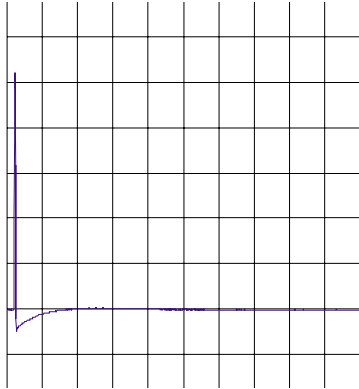

Time domain results of a good hammer tap

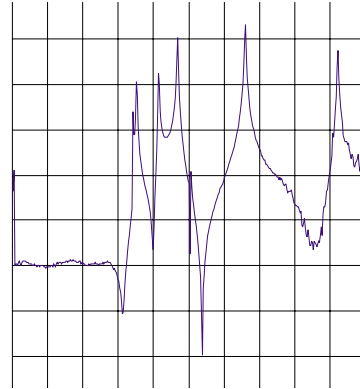

Frequency domain results of a good hammer tap

The following traces show the result of a multiple impact, such as when the hammer bounces.

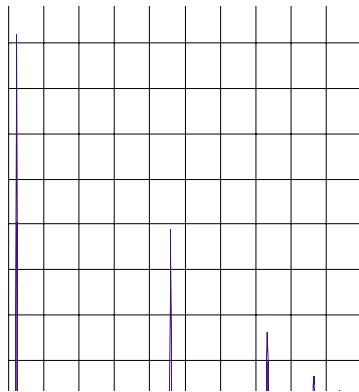

Time domain results of a multiple impact

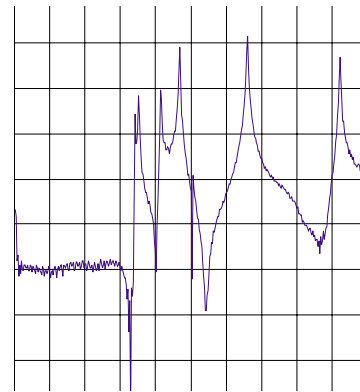

Frequency domain results of a multiple impact

The Agilent 35670A's preview feature allows you to manually or automatically preview the response data from each test before adding it to the average. See online help for more information on manual or timed preview modes.

3

Measuring Sound

This chapter shows you how to connect and calibrate microphones. It also shows you how to make several typical acoustic measurements. These measurements are made using the analyzer's octave analysis mode—available only if your analyzer is equipped with Option 1D1.

To connect the microphone adapter (Option UK4)

- 1 Flip the bail handle down to support the front of the analyzer.
- 2 Insert the threaded ends of the microphone adapter's two thumbscrews into the holes on the bottom of the analyzer's case, then tighten the thumbscrews with your fingers.
- 3 Attach the microphone adapter's mic cable to mic connector on the analyzer's front panel.
- 4 Connect the adapter's BNCs to the corresponding BNCs on the analyzer's front panel.

The Microphone Adapter and Power Supply (Option UK4) simplifies microphone connections. The mic connector on the analyzer's front panel provides 8 Vdc to power the adapter. The adapter's internal power supply uses a step-up converter to provide 28 V and 200 V on the seven-pin input connectors. The 28 V pins power the microphone pre-amplifiers. The 200 V pins polarize the condenser microphone cartridges.

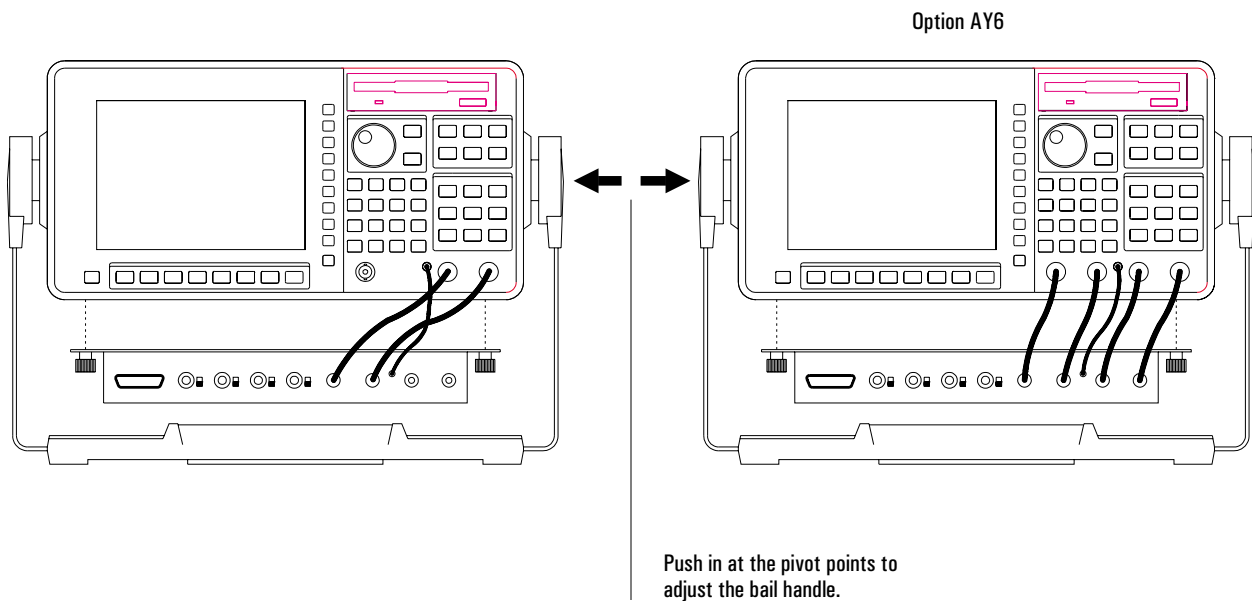

To connect microphones

- 1 Press [**Input**] [ALL CHANNELS] [FRONT END CH* SETUP], then press [COUPLING AC DC] to highlight AC.
- 2 If you are using condenser microphones, set the 200 V polarization voltage switches—located next to the seven-pin input connectors on the microphone power supply—to ON.
or
If you are using electret (prepolarized condenser) microphones, set the switches to OFF.
- 3 Attach the microphone output cables to the seven-pin input connectors as shown in the illustration.

CAUTION

Unlike other condenser microphones, electret microphones do not require an external polarization voltage. To avoid a temporary change in microphone sensitivity (or possible damage), make sure you set the 200 V polarization switch to OFF before attaching an electret microphone to the corresponding seven-pin input connector.

The output signal from a microphone preamplifier usually has a significant dc offset. If the corresponding input channel is dc-coupled, this offset can cause overloads as you increase the channel's sensitivity. You can prevent dc overloads by selecting ac-coupling.

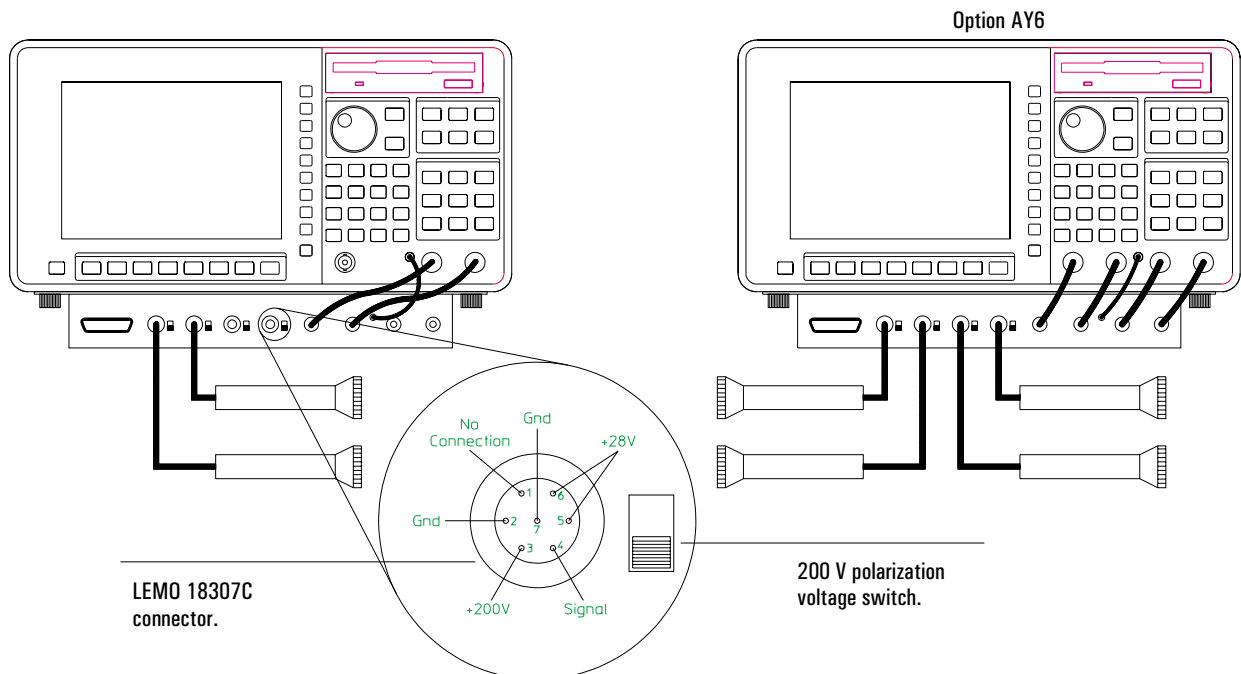

To calibrate a microphone

If you want to accurately measure an acoustic signal, you must enter a calibration factor that tells the analyzer how much voltage is produced at a microphone's output for a given sound pressure level. In the **Agilent** 35670A, you enter this factor with the Transducer (Xdcr) Unit softkeys—located under the **[Input]** hardkey.

1 Initialize the analyzer.

Press **[Preset]** [DO PRESET].

Press **[Inst Mode]** [OCTAVE ANALYSIS].

Press **[CHANNELS 1 2]** (or **[CHANNELS 1 2 4]**) to highlight the number of channels you want activated.

Press **[Meas Data]**, then press **[CHANNEL 1 2]** (or **[CHANNEL 1 2 3 4]**) to highlight the channel whose microphone you will calibrate.

Press **[PWR SPEC CHANNEL x]** to display the microphone output in the active trace.

2 Match the active trace's display unit to the calibrator's output unit.

Press **[Input]**, then press **[CHANNEL 1 2]** (or **[CHANNEL 1 2 3 4]**) to highlight the channel whose microphone you will calibrate.

Press **[XDCR UNIT CHx SETUP]** [XDCR UNIT LABEL] [Pascal].

Press **[Rtn]**, then press **[XDCR UNIT ON OFF]** to highlight ON.

Press **[Trace Coord]** [Y UNITS] [EU].

Press **[AMPLITUDE PK PP RMS]** to highlight RMS.

Press **[dB REF SETUP]** [dB SPL (20 uPa)].

3 Connect the microphone adapter and microphone as described in the preceding tasks, then insert your microphone in the calibrator.

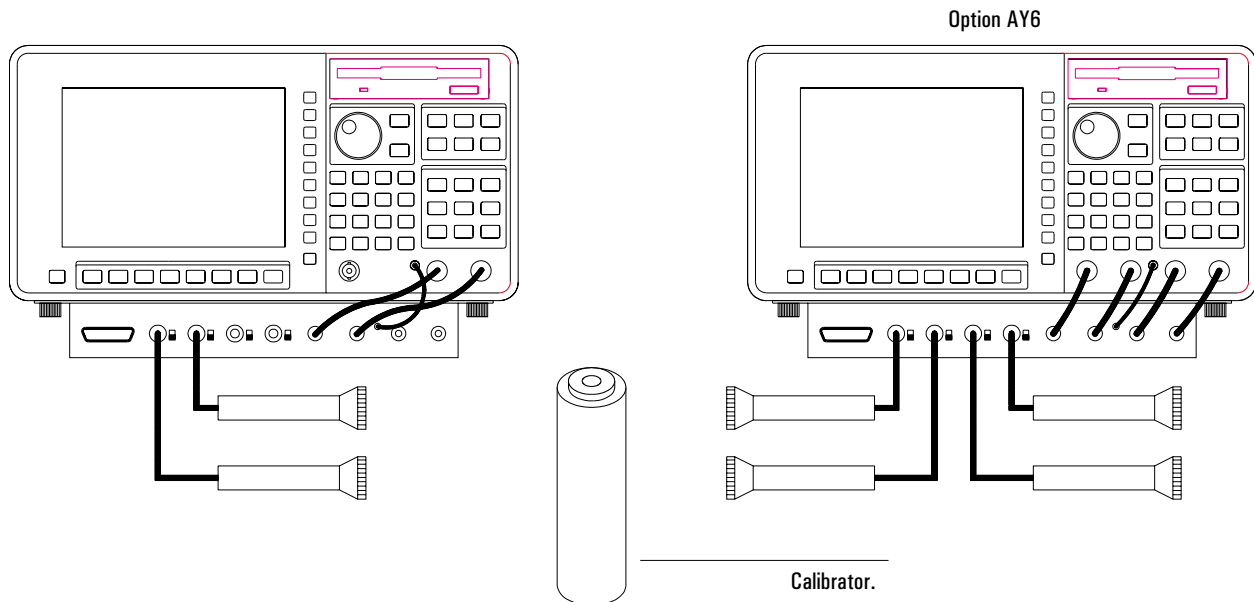

4 Specify the measurement and averaging parameters.

Press [**Input**] [FRONT END CH_x SETUP], then press [A WT FLTR ON OFF] to highlight OFF.

Press [**Avg**] [LINEAR] [AVERAGE TIME] <number> [s] (where <number> is 2 or greater).

5 Press [**Scale**], then press [AUTOSCALE ON OFF] to highlight ON.

6 Turn on the calibrator, then press [**Start**].

7 When the measurement status line says “REAL-TIME MEASUREMENT,” move the marker to the calibrator’s output frequency and enter calibrator’s output amplitude (in dB SPL).

Press [**Marker**] [MARKER TO PEAK].

Press [**Input**] [XDCR UNIT CH_x SETUP] [CAL VALUE AT MKR], then type the calibrator’s specified output amplitude (in dB SPL_{rms}) and press [ENTER].

The analyzer uses the number you enter in [CAL VALUE AT MKR] to calculate a new value for [XDCR SENSITVITY]. This new value is the calibration factor that ensures the accuracy of your microphone measurements. The analyzer automatically stores this value and the [XDCR UNIT LABEL] value in nonvolatile memory, so they will not be lost at preset or power-down. However, the values will be used only when [XDCR UNIT ON OFF] is set to ON.

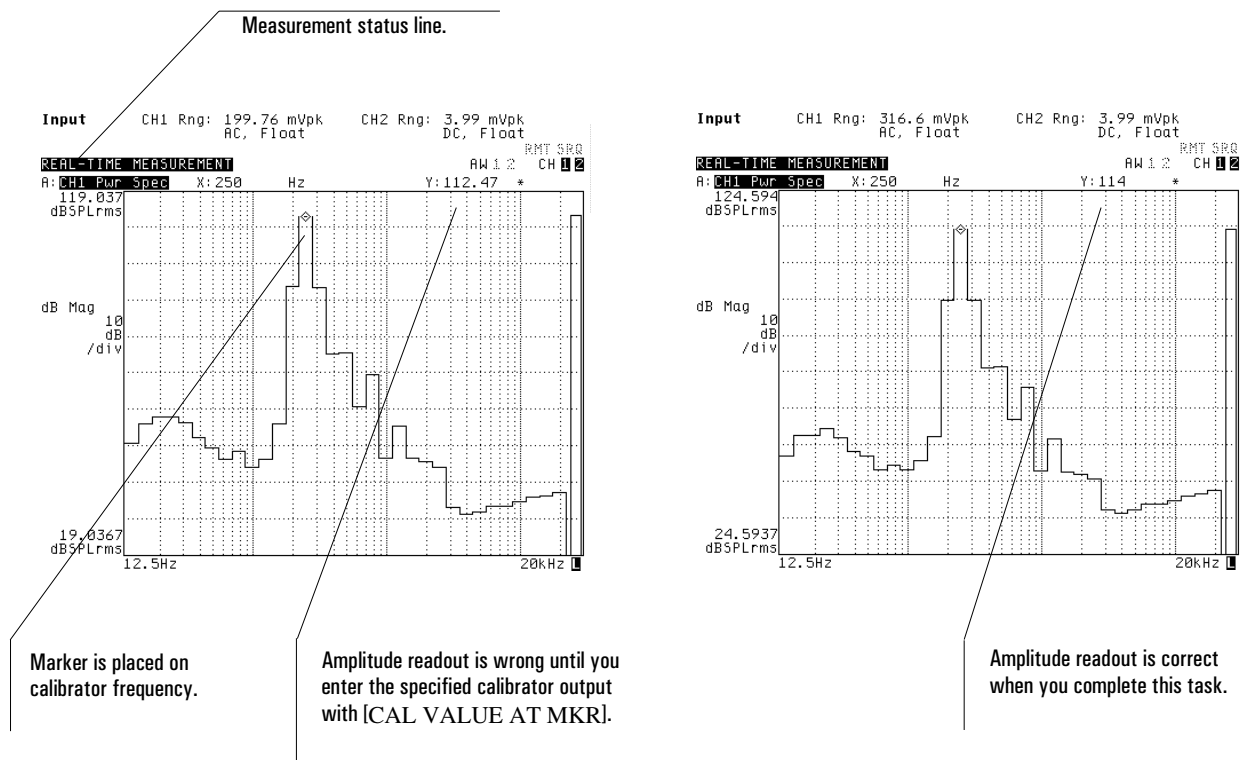

To measure sound pressure level

The Agilent 35670A allows you to measure sound pressure level (SPL) using one of three banks of filters. The filter spacing and bandwidth in these three banks are: one octave (full), one-third octave, and one-twelfth octave. But before you can measure SPL, you must calibrate all the microphones you will use, as shown in the preceding task.

1 Initialize the analyzer.

Complete the preceding task, "To calibrate a microphone."

Press [**Active Trace**], then press [A] if you are measuring with one microphone, [A B] if you are measuring with two, or [A B C D] if you are measuring with three or four.

Press [**Meas Data**] [ALL CHANNELS] [PWR SPEC CHANNEL *] to assign one microphone's output to each trace.

2 Set each calibrated microphone in front of an acoustic energy source.

3 Specify the measurement parameters.

Press [**Freq**], then press [1/1 OCTAVE], [1/3 OCTAVE], or [1/12 OCTAVE] to select filter spacing and bandwidth.

Press [START] <number> <unit>, then press [STOP] <number> <unit> to select the range of frequencies you want to measure.

Press [**Input**] [ALL CHANNELS] [CH* AUTO UP ONLY].

If you want to display A-weighted SPL, press [FRONT END CH* SETUP], then press [A WT FLTR ON OFF] to highlight ON.

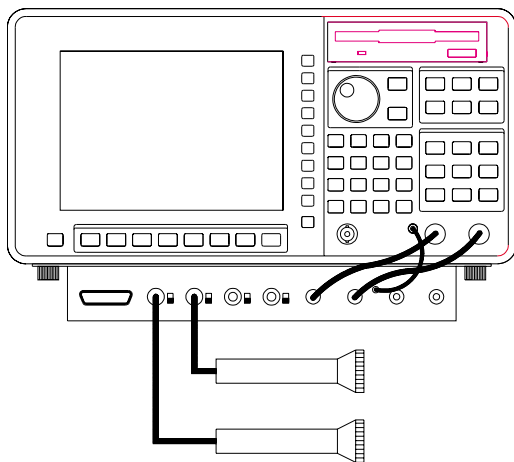

Option AY6

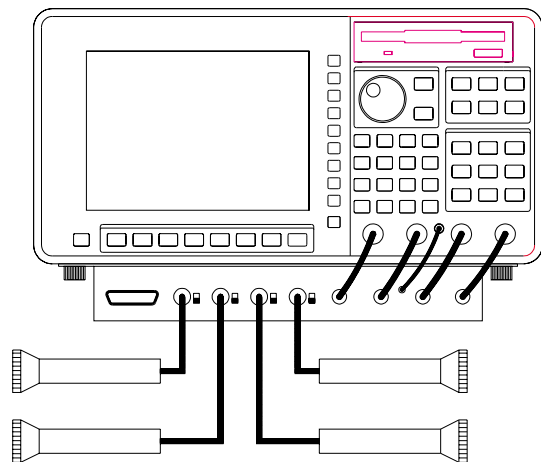

4 Specify the averaging parameters.

Press [Avg].

If you want to duplicate the LEQ function of many sound-level meters, press [LINEAR], then press [AVERAGE TIME] <number> [ENTER] to specify the integration time.

If you want to duplicate the “fast” function, press [EXPONENTL], then press [AVERAGE TIME] 125 [mS].

If you want to duplicate the “slow” function, press [EXPONENTL], then press [AVERAGE TIME] 1 [S].

5 Configure the display.

Press [Scale], then press [AUTOSCALE ON OFF] to highlight OFF, and once more to highlight ON.

6 Measure the DUT.

Press [Start].

The analyzer’s A-weight filters conform to ANSI Standard S1.4-1983 and IEC 651-1979, Type 0 Tolerance. An “AW” indicator—located in the upper-right portion of the screen—shows you which channels have their A-weight filters enabled.

You can improve the amplitude accuracy of your measurement by increasing the value of [AVERAGE TIME] before you press [Start]. [AVERAGE TIME] is grouped with several other averaging parameters under the [Avg] hardkey. See online help for more information on averaging.

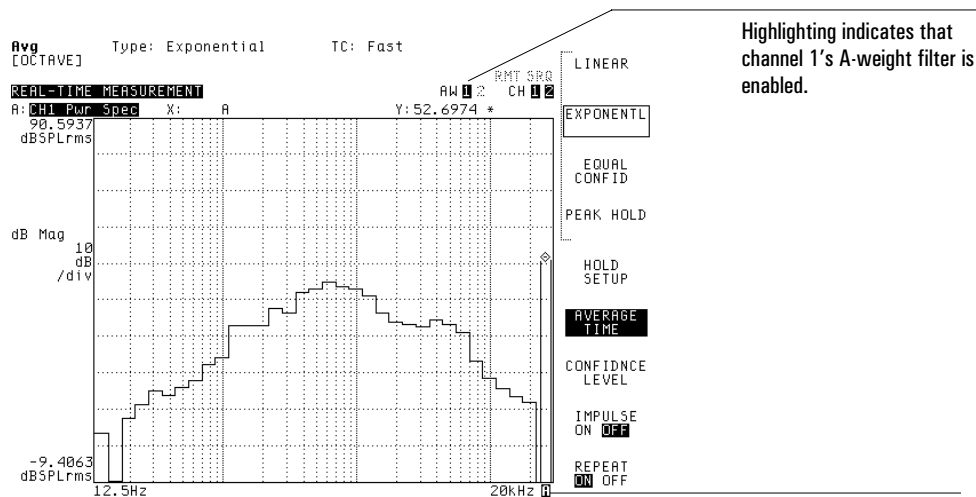

Overall band is labeled “A” when A-weight filter is enabled.

To measure overall sound pressure level

- 1 Complete the preceding task, “To measure sound pressure level.”
- 2 If the A-weight filters are on, press **[Input]** [ALL CHANNELS] [FRONT END CH* SETUP], then press [A WT FLTR ON OFF] to highlight OFF.
- 3 Press **[Disp Format]** [MORE] [OCTAVE BND SETUP], then press [OVERALL ON OFF] to highlight ON.
- 4 Turn the knob to place the marker on the overall band.
- 5 Record the marker readout's Y-axis value.

[OVERALL ON OFF] enables and disables the analyzer's overall band. This band displays band-limited overall SPL—the SPL within the current frequency span—if all of the following things are true:

- Linear, exponential, or equal-confidence averaging is selected (under the **[Avg]** hardkey).
- The impulse detector is turned off (also under the **[Avg]** hardkey).
- The corresponding channel's A-weight filter is turned off (under the **[Input]** [FRONT END CHx SETUP] softkey).

You can also enable a special band that is dedicated to displaying A-weighted, band-limited overall SPL. Just press **[Disp Format]** [MORE] [OCTAVE BND SETUP], then press [WEIGHTED ON OFF] to highlight ON. See online help for more information on either of these two SPL bands.

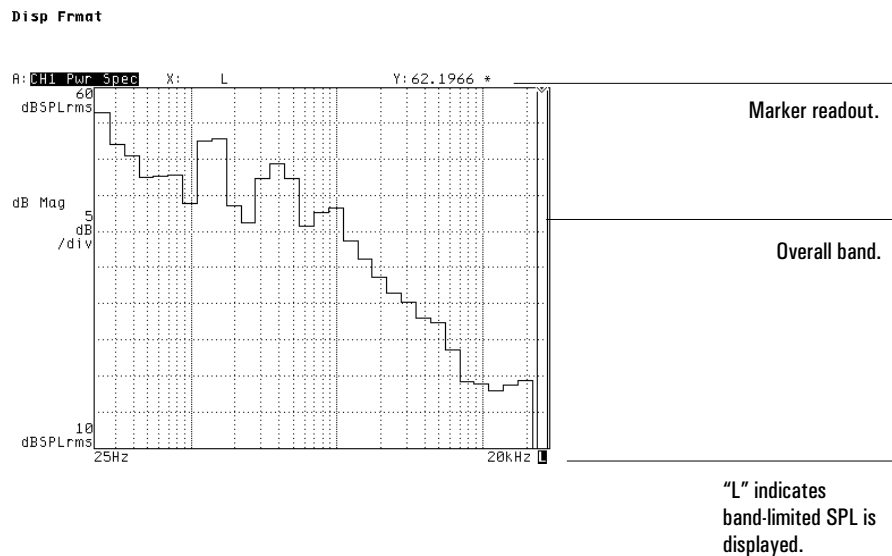

To measure overall impulse characteristics

- 1 Complete the task, “To measure sound pressure level.”
- 2 Press [A_{vg}], then press [IMPULSE ON OFF] to highlight ON.
- 3 Press [Disp Format] [MORE] [OCTAVE BND SETUP], then press [OVERALL ON OFF] to highlight ON.
- 4 Turn the knob to place the marker on the overall band.
- 5 Record the marker readout's Y-axis value.

The overall band displays broadband overall SPL (sound pressure level) with exponential time weighting when the analyzer's impulse detector is turned on. The displayed value meets the IEC 651 standard for impulse characteristics. Online help for [IMPULSE ON OFF] contains a table defining broadband for different analyzer setups.

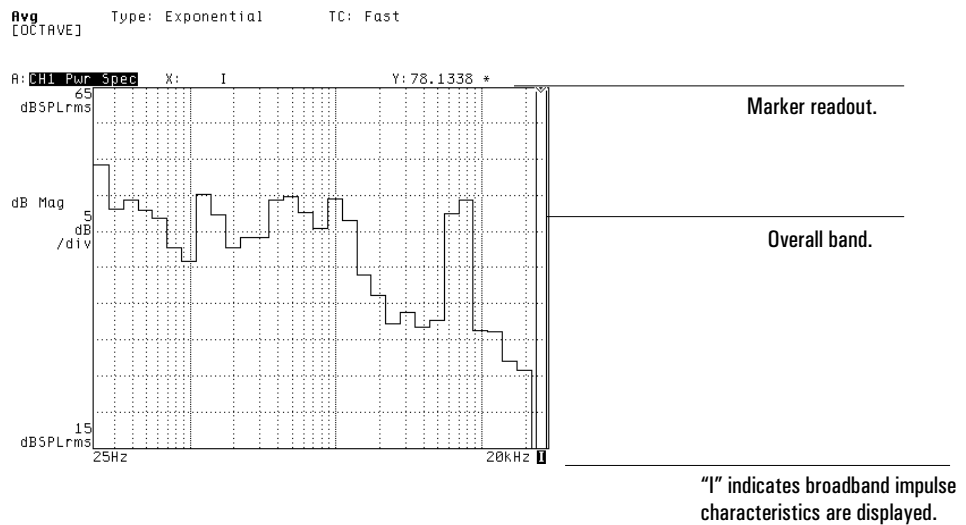

Measuring Spectra and Networks

This chapter shows you how to make several typical spectrum and network measurements. Most of the measurements are made using the analyzer's FFT analysis mode, but one frequency response measurement is made using the swept sine mode—available only if your analyzer is equipped with Option 1D2.

To measure a wideband spectrum

You must sometimes survey all frequencies within the analyzer's measurement range to locate the signal components you want to examine more closely. A two-channel Agilent 35670A, can measure all frequencies between 0 and 102.4 kHz when one channel is active; it can measure between 0 and 51.2 kHz when two channels are active. A four-channel Agilent 35670A can measure all frequencies between 0 and 51.2 kHz when one or two channels are active; it can measure between 0 and 25.6 kHz when four channels are active.

1 Initialize the analyzer.

Press [**Preset**] [DO PRESET].

Press [**Inst Mode**] [FFT ANALYSIS].

Press [CHANNELS 1 2] (or [CHANNELS 1 2 4]) to highlight the number of channels you want activated.

Press [**Active Trace**], then press [A] if you are measuring one signal, [A B] if you are measuring two, or [A B C D] if you are measuring three or four.

Press [**Meas Data**] [ALL CHANNELS] [PWR SPEC CHANNEL *].

2 Connect your test signals to the input connectors (as shown below).

3 Specify the measurement parameters.

Press [**Freq**] [FULL SPAN].

Press [**Window**] [FLAT TOP].

If the signals include large dc components, press [**Input**] [ALL CHANNELS] [FRONT END CH* SETUP], then press [COUPLING AC DC] to highlight AC.

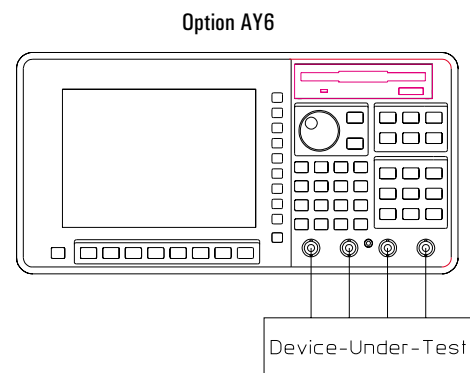
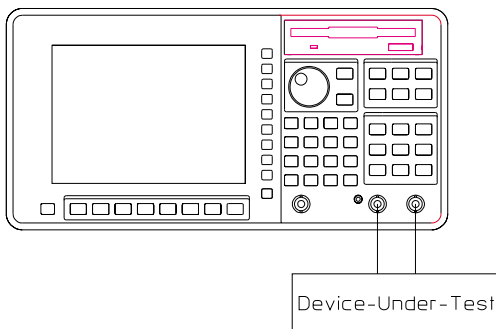

4 If you suspect that a low-level component of the test signal is being obscured by the noise floor, turn on averaging.

Press [**Avg**] [AVERAGE TYPE] [RMS] [**Rtn**].
Press [NUMBER AVERAGES] <number> [ENTER].
Press [AVERAGE ON OFF] to highlight ON.

5 Configure the display.

Press [**Trace Coord**], then press [LOG MAGNITUDE] if you want Y-axis values to read out in volts, or [dB MAGNITUDE] if you want them to read out in dBV.
Press [**Scale**] [Y PER DIV (DECADES)], then press the up-arrow or down-arrow hardkey to compress or expand the trace along the Y-axis.

6 Measure the signal.

Press [**Start**].

Most menus that are used to change channel-specific parameters also include a pair of channel selector softkeys. These softkeys allow you to direct changes to a single channel or to all channels at once. In a two-channel Agilent 35670A, the selector softkeys are [CHANNEL 1 2] and [ALL CHANNELS]. In a four-channel Agilent 35670A, they are [CHANNEL 1 2 3 4] and [ALL CHANNELS]. When you select [CHANNEL 1 2] (or [CHANNEL 1 2 3 4]), subsequent changes are directed to the highlighted channel. (The analyzer cycles through the available channels each time you press the this softkey.) When you select [ALL CHANNELS], subsequent changes are directed to all active channels.

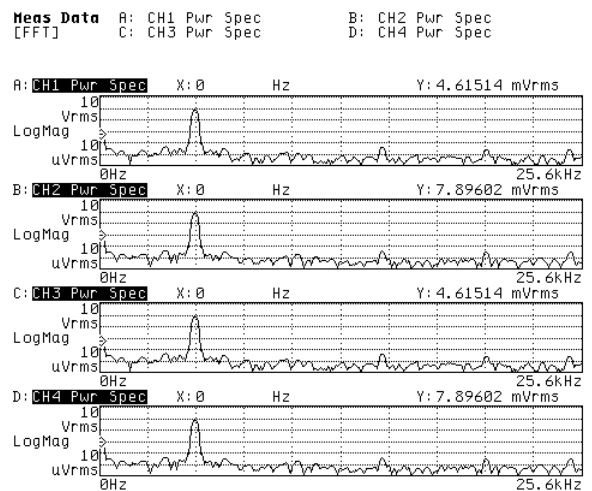
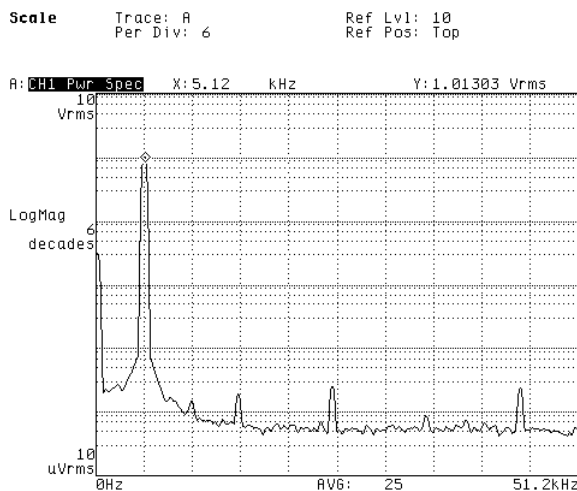

To measure a narrowband spectrum

- 1 Complete the previous task, “To measure a wideband spectrum.”
- 2 Activate the trace containing the signal component you want to examine more closely.
- 3 Press **[Marker]**, then press **[MARKER ON OFF]** to highlight ON.
- 4 Turn the knob to place the marker on the component.
- 5 Press **[Freq]** **[CENTER]**, then press the **[Mkr Value]** hardkey (located on the numeric keypad).
- 6 Press **[SPAN]**, then press the down-arrow hardkey to narrow the frequency span.
- 7 If averaging is enabled, press **[Start]** to begin measuring.

The **[Mkr Value]** hardkey provides a quick way to enter the current value of the marker readout in a numeric entry softkey. It enters either the X-axis value or the Y-axis value, depending on the requirements of the softkey. Be sure that **[MARKER ABS REL]** (in the Marker menu) is set to ABS so the readout values represent the marker's actual position rather than its position relative to the marker reference.

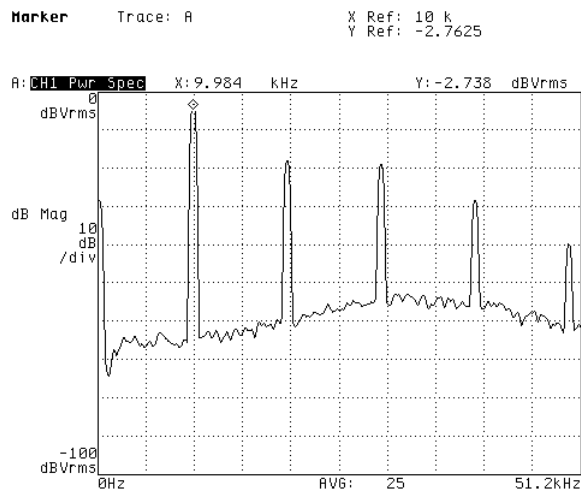

Close-in sidebands on this 10.000 kHz crystal oscillator signal are not visible with a wideband spectrum.

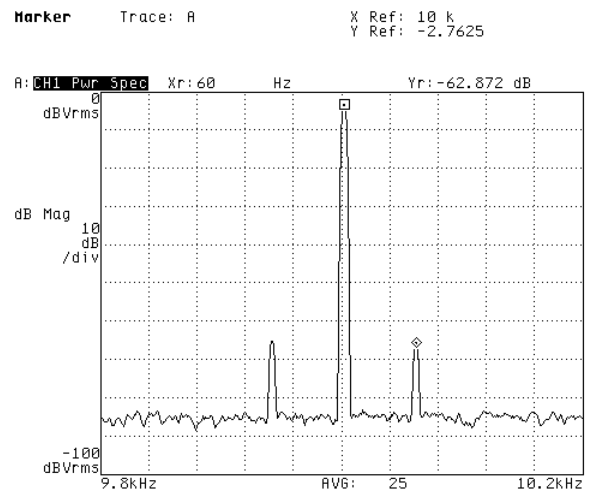

A narrowband spectrum reveals low-level 60 Hz sidebands.

To measure frequency and amplitude

- 1 Complete the one of the previous tasks: “To measure a wideband spectrum” or “To measure a narrowband spectrum.”
- 2 Activate the trace containing the signal component you want to measure.
- 3 If the marker is not already turned on, press [**Marker**], then press [MARKER ON OFF] to highlight ON.
- 4 Turn the knob to place the marker on the component.
- 5 Read the frequency and amplitude from the marker readout.

The [SPAN] and [RESOLUTN (LINES)] softkeys—located under the [**Freq**] hardkey—control the frequency resolution of the marker readout. Resolution increases when you decrease the span or when you increase the number of lines that are used to divide the span.

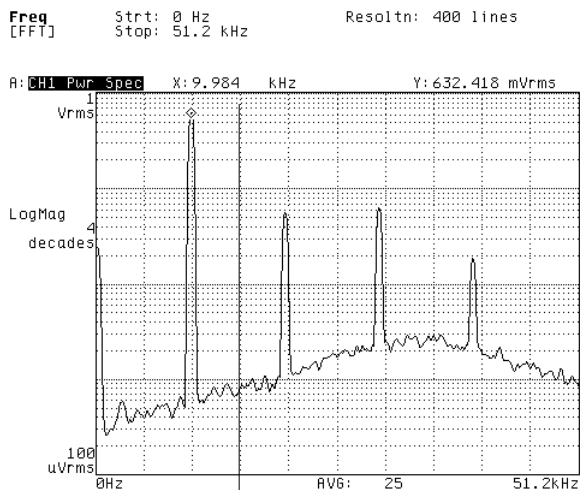

Frequency resolution is poorest at full-span—marker readout for a 10.000 kHz crystal reads 9.984 kHz.

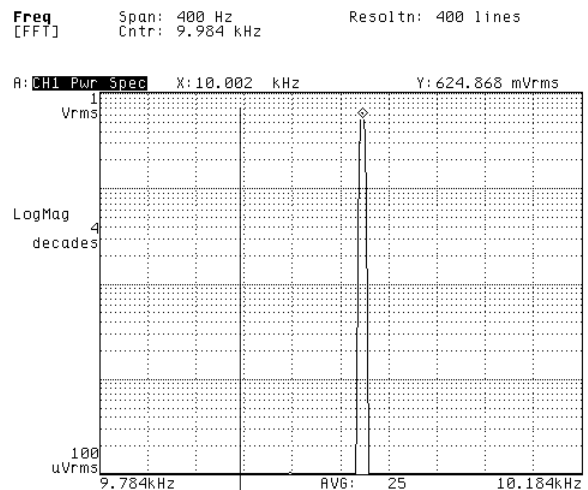

Frequency resolution increases when using a narrower span—marker readout now indicates 10.002 kHz.

To measure noise power (PSD)

- 1 Complete the one of the previous tasks: “To measure a wideband spectrum” or “To measure a narrowband spectrum.”
- 2 Activate the trace you want to measure.
- 3 If the marker is not already turned on, press [**Marker**], then press [MARKER ON OFF] to highlight ON.
- 4 Turn the knob to place the marker on the noise floor.
- 5 Press [**Trace Coord**] [Y UNITS] [V²/Hz (PSD)].
- 6 Read the power spectral density (PSD) value from the marker readout.

When you select PSD units from the Y Units menu, amplitude values—including those in the marker readout—are normalized to a 1 Hz bandwidth. Use the following guidelines for accurate results:

- The noise you are measuring should be random.
- A fairly large number of measurements—100 or more—should be averaged together using rms averaging.
- The marker should not be placed on any discrete component.

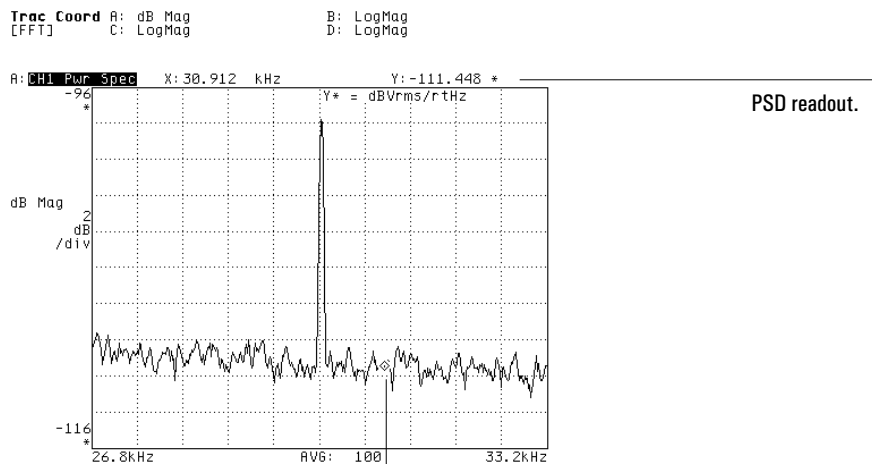

For PSD measurements, move the marker to a typical spot on the noise floor—do not place the marker on a discrete component.

To measure harmonic distortion

- 1 Complete the task, “To measure a wideband spectrum.”
- 2 Activate the trace you want to measure.
- 3 Press [**Marker**] [MARKER TO PEAK] to place the marker on the fundamental frequency.
- 4 Press [**Marker Fctn**] [HARMONIC MARKER] [FUNDAMNTL FREQUENCY], then press the [**Mkr Value**] hardkey (located on the numeric keypad).
- 5 If the harmonic markers do not quite line up with the harmonics, adjust the value of [FUNDAMNTL FREQUENCY]—using the knob, the arrow keys, or the direct numeric entry—until they do.
- 6 Press [THD].

When you press [THD], the analyzer displays total harmonic distortion (THD) at the bottom-left corner of the trace you are measuring. The analyzer automatically limits the number of harmonics included in the THD calculation to those included in the current frequency span. You can further limit the number of harmonics by changing the value of [NUMBER OF HARMONICS].

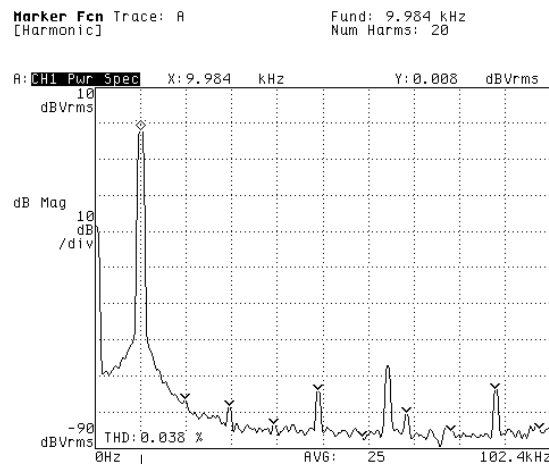

The result of the THD calculation appears here—in this example, the THD is 0.038 percent.

To measure sideband power

- 1 Complete the one of the previous tasks: “To measure a wideband spectrum” or “To measure a narrowband spectrum.”
- 2 Activate the trace you want to measure.
- 3 Press **[Marker]** [MARKER TO PEAK] or turn the knob to place the marker on the carrier frequency.
- 4 Press **[Marker Fctn]** [SIDEBAND MARKER] [CARRIER FREQ], then press the **[Mkr Value]** hardkey (located on the numeric keypad).
- 5 Press **[Marker]** [REFERENCE SETUP] [REFERENCE TO MARKER], then turn the knob to place the main marker on the first sideband to the right or left of the carrier.
- 6 Press **[Marker Fctn]** [SIDEBAND MARKER] [SIDEBAND INCREMENT] **[Mkr Value]**.
- 7 If the sideband markers do not quite line up with the sidebands, adjust the value of [SIDEBAND INCREMENT] until they do.
- 8 Press [SIDEBAND POWER].

When you press [SIDEBAND POWER], the analyzer displays the rms summation of all marked sidebands at the bottom-left corner of the trace you are measuring. You can limit the number of sidebands included in the summation by changing the value of [NUMBER OF SIDEBANDS].

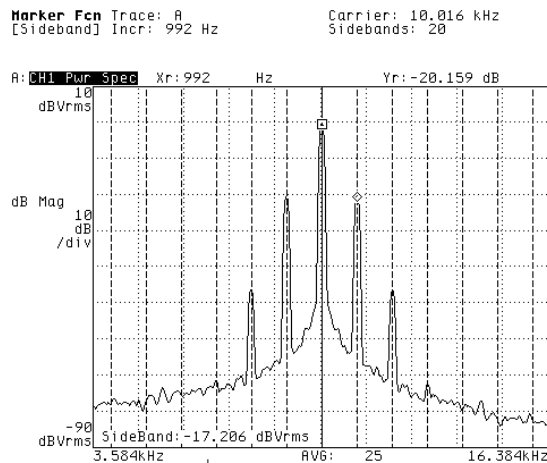

The result of the sideband power calculation appears here.

To display a spectral map

- 1 Complete the one of the previous tasks: “To measure a wideband spectrum” or “To measure a narrowband spectrum.”
- 2 Activate the trace you want to use for the spectral map.
- 3 Press [**Disp Format**] [WATERFALL SETUP], then press [WATERFALL ON OFF] to highlight ON.
- 4 If averaging is enabled, press [**Avg**], then set [FAST AVG ON OFF] to ON, [REPEAT ON OFF] to ON, and [UPDATE RATE] equal to [NUMBER AVERAGES].
- 5 Press [**Start**] to begin measuring.

When rms, time, or peak hold averaging is selected, the analyzer normally stops measuring after it has finished averaging the specified number of measurements. Setting [REPEAT ON OFF] to ON allows the analyzer to begin averaging another set of measurements immediately after it finishes the preceding set. Setting [FAST AVG ON OFF] and [UPDATE RATE] as described in step 4 ensures that each trace in the map represents a completed average.

For more information on using the waterfall feature, refer to online help or chapter 9, “Formatting the Display.”

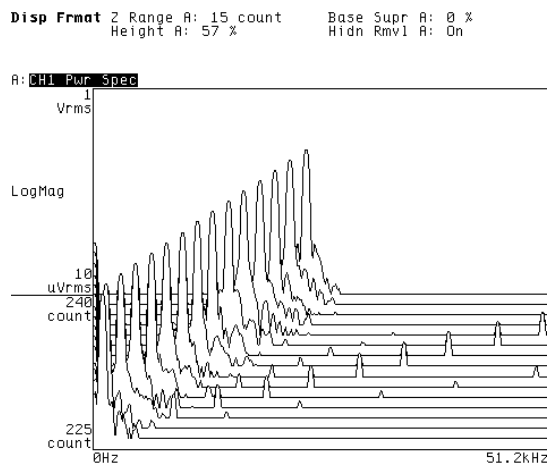

In the example here, a spectral map clearly reveals frequency change of the swept test signal.

To measure frequency response—FFT

FFT analysis allows you to measure a device's frequency response more quickly than swept sine analysis. However, if the dynamic range of your device exceeds 80 dB, you should use swept sine analysis—as described in “To measure frequency response—swept sine.”

1 Initialize the analyzer.

Press [**Preset**] [DO PRESET].

Press [**Inst Mode**] [FFT ANALYSIS].

If you are using a two-channel Agilent 35670A, press [CHANNELS 1 2] to highlight 2.

If you are using a four-channel Agilent 35670A, press [CHANNELS 1 2 4] to highlight 2 or 4, then press [REF CHANS 1 1,3] to highlight 1.

Press [**Meas Data**] [FREQ RESP 2/1], then—if you are measuring with four

channels—press [CHANNEL 1 2 3 4] to highlight the response channel you want observe.

2 Connect your device-under-test (DUT) to the source and input connectors (as shown below).

3 Specify the measurement parameters.

Press [**Freq**] [START] <number> <unit>, then press [STOP] <number> <unit>.

Press [**Source**] [PERIODIC CHIRP] [LEVEL] <number> <unit>.

Press [SOURCE ON OFF] to highlight ON.

Press [**Window**] [UNIFORM].

Press [**Input**] [ALL CHANNELS] [CH* AUTO UP ONLY].

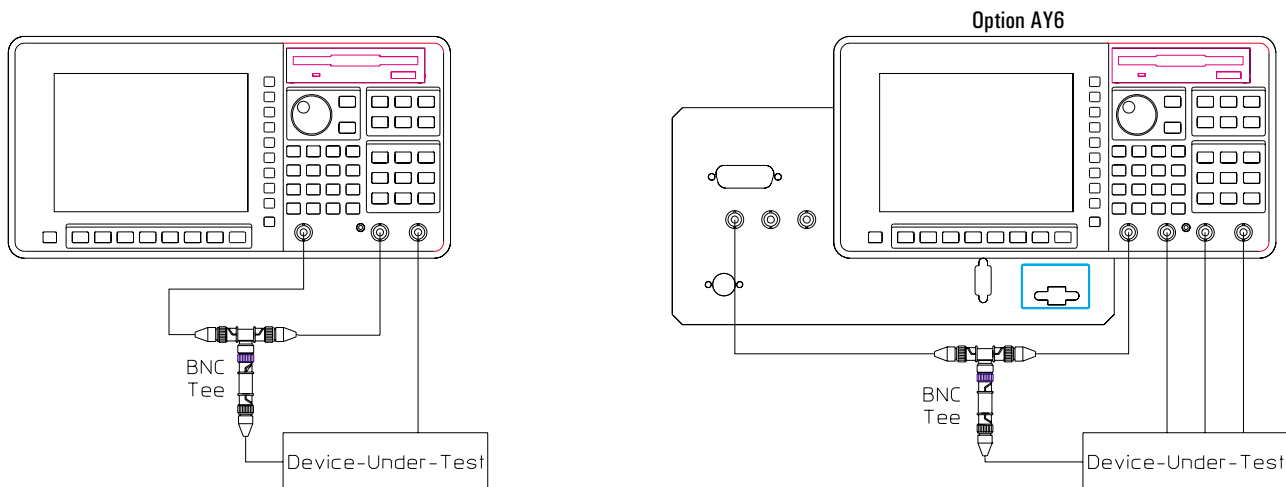

4 Specify the triggering parameters.

Press [Trigger] [SOURCE TRIGGER].

5 Configure the display.

Press [Disp Format] [MORE] [BODE DIAGRAM].

Activate all displayed traces.

Press [Scale], then press [AUTOSCALE ON OFF] to highlight ON.

If you would rather display the measurement data with a linear X-axis, press [Trace Coord], then press [X-AXIS LIN LOG] to highlight LIN.

6 Measure the DUT.

Press [Start].

A four-channel Agilent 35670A can measure frequency response using one reference channel or two reference channels. When you set [REF CHANS 1 1,3] to 1 (as described in this task), the analyzer uses channel 1 as the reference for channels 2, 3, and 4. When you set it to 1,3, the analyzer uses channel 1 as the reference for channel 2 and channel 3 as the reference for channel 4.

A periodic chirp is self-windowing signal that provides an equal amount energy at all frequencies within the current span. This signal does not differ from one measurement to the next, so you can obtain good measurement results without averaging. Averaging is required for this signal type only if you plan to evaluate the quality of your measurement with coherence data (selected under the [Meas Data] hardkey).

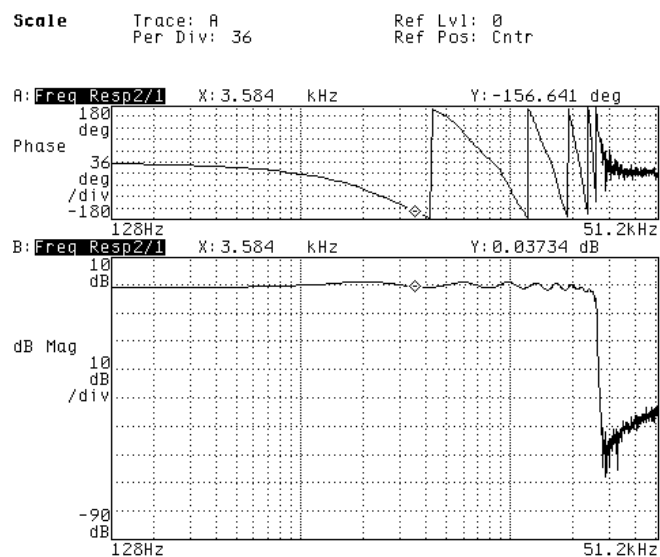

To measure frequency response—swept sine

When you measure a device that has a wide dynamic range, or one that covers several decades of frequency range, swept sine analysis can provide better frequency response results than FFT analysis. Swept sine analysis is possible only if your analyzer is equipped with Option 1D2.

1 Initialize the analyzer.

Press [**Preset**] [DO PRESET].

Press [**Inst Mode**] [SWEPT SINE].

If you are using a four-channel Agilent 35670A, press [CHANNELS 1 2 4] to highlight 2 or 4, then press [REF CHANS 1 1,3] to highlight 1.

Press [**Meas Data**] [FREQ RESP 2/1], then—if you are measuring with four channels—press [CHANNEL 1 2 3 4] to highlight the response channel you want observe.

2 Connect your device-under-test (DUT) to the source and input connectors (as shown below).

3 Specify the measurement parameters.

Press [**Freq**] [START] <number> <unit>, then press [STOP] <number> <unit>.

Press [RESOLUTN SETUP] [RESOLUTN] <number> <unit> to specify the number of measurement points.

Press [SWEEP LIN LOG] to highlight LIN if you want the measurement points to be linearly space, or to highlight LOG if you want them to be logarithmically spaced.

Press [**Input**] [ALL CHANNELS] [CH* AUTO RANGE].

Press [**Source**] [LEVEL] <number> <unit>.

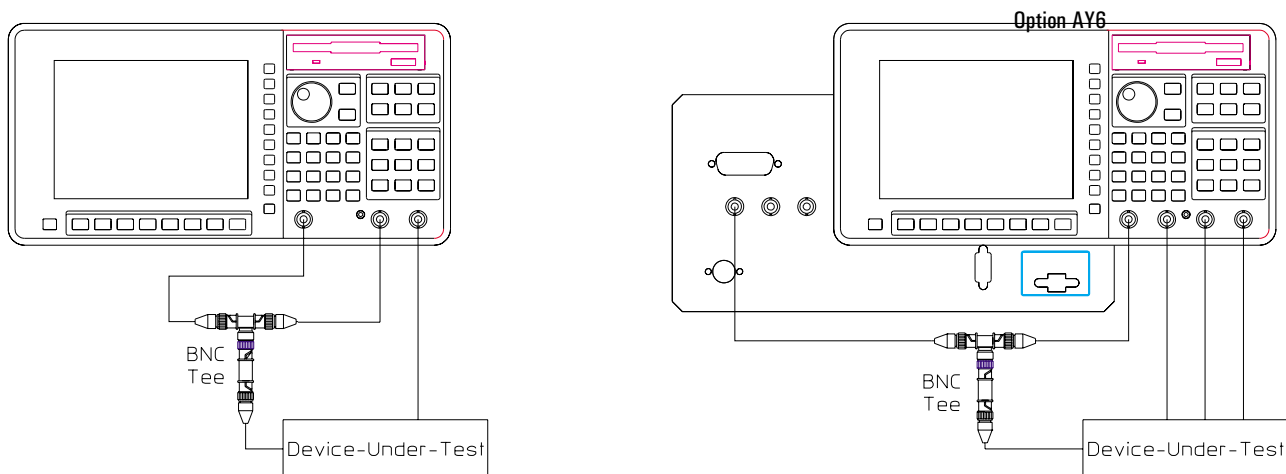

4 Configure the display.

Press [**Scale**], then press[AUTOSCALE ON OFF] to highlight ON.

5 Specify the averaging parameters.

Press [**Avg**] [INTEGRATE TIME] <number> [CYCLES].

6 Measure the DUT.

Press [**Start**].

If you want to change the direction of the sweep during the measurement, press [**Freq**] [SWEEP UP DOWN].

Swept sine analysis lets you select linear or logarithmic spacing of the measurement points within the specified frequency span. Logarithmic spacing is a better choice when the span covers several decades. You can reduce the amount of time it takes to complete either a linear or logarithmic sweep by enabling the analyzer's autoresolution feature. You can enable this feature by pressing [**Freq**] [RESOLUTN SETUP], and then pressing [AUTO RES ON OFF] to highlight ON.

See online help for more information on [AUTO RES ON OFF]. See online help or the previous topic for more information on [REF CHANS 1 1,3].

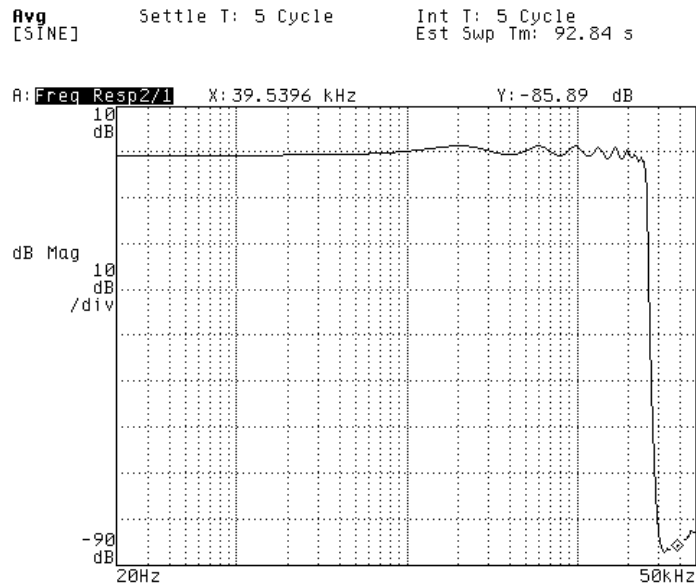

To measure phase distortion

- 1 Complete either the FFT or the swept sine version of the task, “To measure frequency response.”
- 2 Activate the trace you will use to measure phase distortion.
- 3 Press [Trace Coord] [MORE CHOICES] [GROUP DELAY].
- 4 Press [DELAY APERTURE] <number> [ENTER].
- 5 Press [Scale], then press [AUTOSCALE ON OFF] to highlight ON.

Group delay is the derivative (or slope) of the phase response. This makes it useful for measuring a device’s phase linearity. The formula for group delay is:

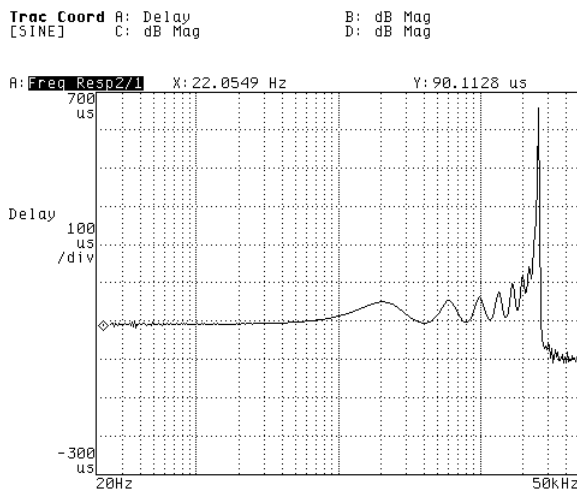

Group-delay trace using a 0.25% aperture.

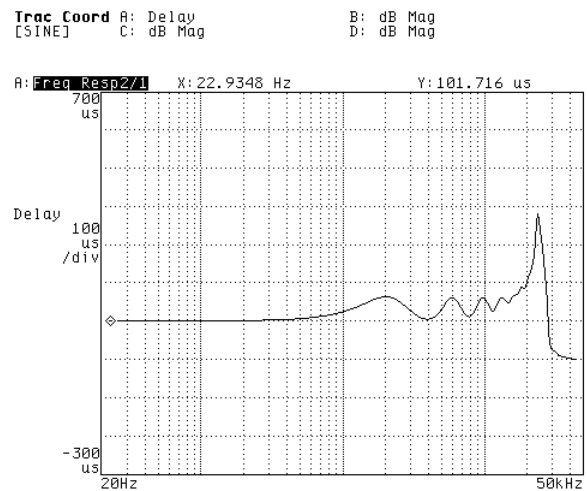

The same trace using a 2.5% aperture.

5

Measuring Control Systems

Measuring Control Systems

The Agilent 35670A is useful for characterizing the performance and stability of a control system. Performance parameters, such as rise time, overshoot, and settling time, are generally specified in the time domain. Stability criteria, gain/phase margins, are generally specified in the frequency domain. The Agilent 35670A measures both in the time and frequency domains.

General Model of a Control System

The standard model of a single loop control system consists of

- an input signal called the reference signal (r)
- a device or a process to control (called the “plant”)
- a sensor to measure the response of the plant (c)
- a feedback element, H , and summation block to give an indication (b) of the output (c) so that they may be combined with the original control signal to form an error signal (e)
- an error signal, that is sent to the plant such that c is driven to minimize the error between c and r

Figure 5-1 is a generic block diagram of a control or “servo” system. The plant’s transfer function is G . The feedback transfer function is H . The goal is to optimize closed loop performance. This is done by modifying the open loop elements. Ideally, the control loop output (c) tracks the input (r) perfectly in the time domain; the gain (output/input) is 1 and there is no phase lag between input and output.

Figure 5-1

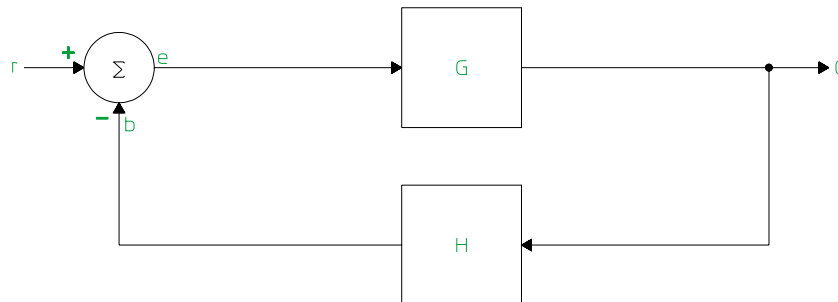

Block Diagram of a Control System

In a real environment there are external and internal disturbances that can affect the system's performance. In addition, the physical nature of the closed loop system can cause it to be unstable or lack required performance. Compensation is added to either the feed-forward or feedback loop to improve performance and to ensure acceptable stability margins. Figure 5-2 shows a feed-forward compensation block with a transfer function G_c , and a feedback compensation block with transfer function H . Many variations are possible.

- The control loop may be composed of mechanical devices and/or analog or digital electrical elements.
- The compensation may be missing in which case G_c and $H = 1$.
- The compensation may be combined with other elements. Examples of this are discussed in the next section.

Figure 5-2

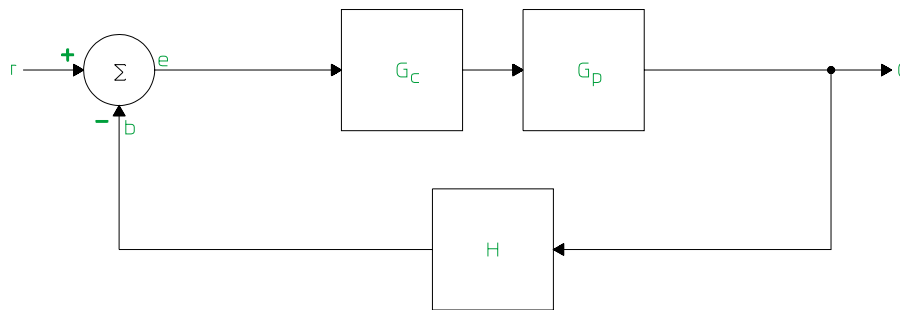

Compensation Added to Forward Path

Closed-loop systems as shown in figure 5-1 can be expressed as

$$C/R = G / (1 + GH)$$

Solving for the open loop transfer function (b/e)

$$b = (r - b) GH$$

$$e = r - eGH$$

$$b/r = GH / (1 + GH) \quad e/r = 1 / (1 + GH)$$

The open loop transfer function is

$$b/e = GH$$

Where:

$$G = G_c G_p$$

G_c is the transfer function of the compensation network

G_p is the transfer function of the "plant" or process

H is the transfer function of the feedback network

Variations from the General Model

To analyze the performance of a control system, you must introduce a stimulus and monitor the effect. Some control systems have special requirements for testing and analyzing the results. This may limit how you approach setting up the measurement.

- Some systems have access to the signals between blocks. Printers and plotters that move a head around may have one chip that performs as a summing junction, compensation block, and feedback block; so, access to the signals is limited.
- Sometimes the signals of interest are in a form that is difficult to measure. If the plant is a motor, the signal that drives it may be pulse-width modulated. In a switching power supply, the output signal may be a very large voltage. When the error signal (e) is analog, it may be so small that the signal-to-noise ratio is poor.
- Some systems require a stimulus signal $r \neq 0$. Testing disk drives requires that the disk be operating at all times; in this case r cannot equal 0. The test stimulus must be injected in the forward gain path, usually between the output of the compensator and the input to the power amplifier. This injection point may need to be added to the circuit via two cascading-inverting op amps. This affects the math and your approach. However, if $r(t)$ is uncorrelated to the stimulus signal, it can be treated as noise and averaging can be used to remove its effects.

Designing the System

Control system design requires measuring the performance parameters of the system, measuring the stability of the system, and modeling the control loops.

Typically, you start by drawing a block diagram that represents your system, including signal paths, types, and levels. Next, you work out the math that shows how to derive the open loop response from the measurement. After making a closed loop measurement, you can use the Agilent 35670A's math operations to transform the measurement into the open loop response.

Analyzing Test Results

Once you have measured the performance and stability of a system, you should verify that your control system model is correct. You can do this by using the Agilent 35670A's optional curve fitter to derive the poles and zeros of the response and update your model.

Curve fitting is the process of estimating linear system parameters of a mathematical model of a physical system. The model closely approximates the measured frequency response of the physical system in a least-squares-error optimal manner. The result of a curve fit operation is a table of poles and zeros. Chapter 16, "Curve Fit," explains how to use the Agilent 35670A's curve fit features.

Checking Your Design

If your model is accurate, you can design a compensator to improve the performance of the control system to desired specifications. You can synthesize the compensator and use the Agilent 35670A's math operations to multiply the compensator's synthesized response with the open loop response. This gives you the open loop response you would expect if you build the compensator, add it to the system and measure the compensated system.

Chapter 15, "Synthesis," and chapter 18, "Math Operations," explain how to use the Agilent 35670A's synthesis feature (Option 1D3) and math operations.

Measuring Control System Performance

Several measures of performance can be derived from a step response. Parameters such as rise time, overshoot, delay time, and settling time are measured in the time domain. The Histogram/Time instrument mode provides the highest accuracy time analysis. Time analysis markers measure the critical time parameters. See figure 5-3.

The rise time of a step response provides a measure of how fast a system can initially achieve the desired output level. The maximum overshoot provides a relative measure of the maximum output level resulting from a specific input. The steady-state deviation indicates a constant error in achieving a desired output. Settling time is a measure of how long it takes the system to settle to its steady-state value. The settling time can be interpreted as a relative measure of stability with short settling time considered more stable than a long settling time.

The analyzer's anti-alias filters have an input step response that can contribute a significant time domain error to the measured system step response. The Agilent 35670A bypasses both the analog and digital anti-alias filters in Histogram/Time instrument modes to minimize this error.

The tasks in this section use a step waveform. The Agilent 35670A's arbitrary source, Option 1D4, allows you to build such a custom source signal. For more information about using the Agilent 35670A's arbitrary source, see chapter 6.

Figure 5-3.

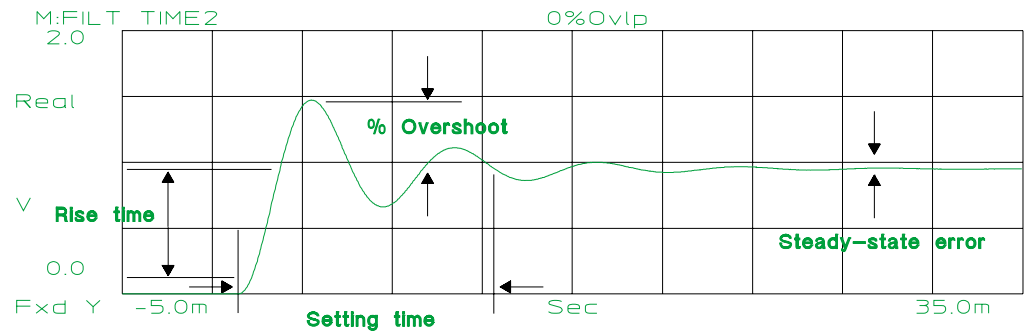

Step Response

To measure a step response

The primary objective in designing a control system is to construct a system that achieves the desired output level as fast as possible and maintains that output with little or no variation or steady state error. The step response is a technique that measures a control system's compliance with the design goals. This task utilizes a step signal created with the Arbitrary Source, Option 1D4.

- 1 Create and store a step signal in data register D1.

See "To create a step signal" in chapter 6.

- 2 Initialize the analyzer.

Press **[Preset]** [DO PRESET].

Press **[Inst Mode]** [HISTOGRAM/TIME].

Press **[Meas Data]**.

Press [CHANNEL 1 2 3 4] to highlight 2.

Press [UNFILTERD TIME CH2].

- 3 Connect the device-under-test (DUT) as shown in the illustration below.

- 4 Specify the measurement parameters.

Press **[Freq]** [RECORD TIME] <number> <unit>.

Press **[Input]** [CH1 FIXED RANGE] <number> <unit>.

Press **[Source]** [MORE CHOICES] [ARBITRARY (D1 - D8)].

Press **[Rtn]**.

Press [LEVEL] <number> <unit>.

Press [SOURCE ON OFF] to highlight ON.

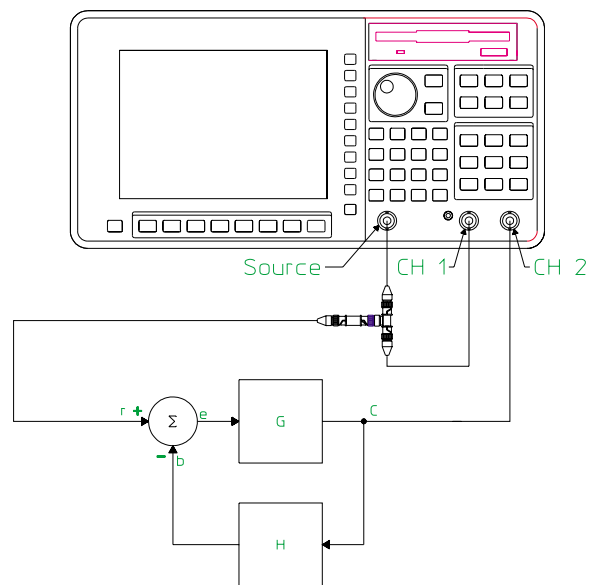

5 Specify the triggering parameters.

Press [**Trigger**] [SOURCE TRIGGER].

Press [TRIGGER SETUP].

Press [CHANNEL 1 2 3 4] to highlight 2.

Press [CHANNEL 2 DELAY] <number> <unit>.

6 Configure the display.

Press [**Scale**], then press[AUTOSCALE ON OFF] to highlight ON.

7 Measure the DUT.

Press [**Start**].

The step response is the measured reaction of the control system to a step change in the input. If you are using the arbitrary source, be sure that data register D1 contains the arbitrary source step signal.

In Histogram/Time instrument mode, the anti-alias filter and A-weight filters are automatically disabled.

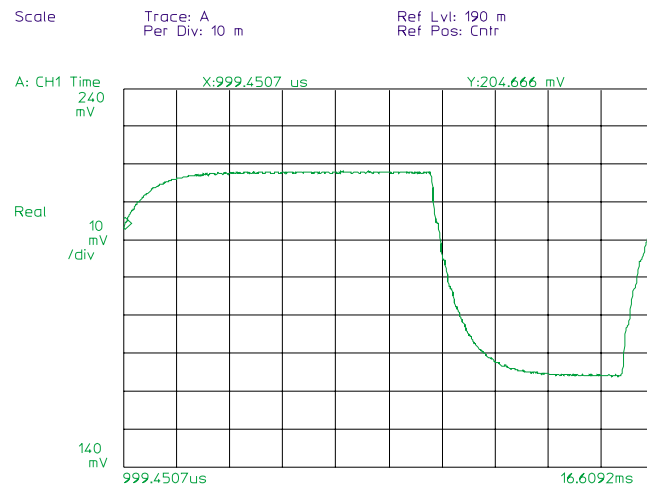

To measure performance parameters

- 1 Measure a step response.
- 2 Press [**Pause-Cont**].
- 3 Press [**Marker Fctn**] [TIME PARAMTERS].
Press [START TIME] <number> <unit>.
or
Use the knob to move the marker to the appropriate start time.
- 4 Press [STOP TIME] <number> <unit>.
or
Use the knob to move the marker to the steady-state level.
- 5 Press [OVERSHOOT].
Press [RISE TIME].
Press [SETTLING TIME].
Press [DELAY TIME].

This task uses a step signal to stimulate the control system. The Time Markers measure the critical time domain characteristics of the control system. Delay time and settling time are relative to the rising edge of the input signal. Selecting an accurate start time is critical to computing accurate values.

Steady-state line on display

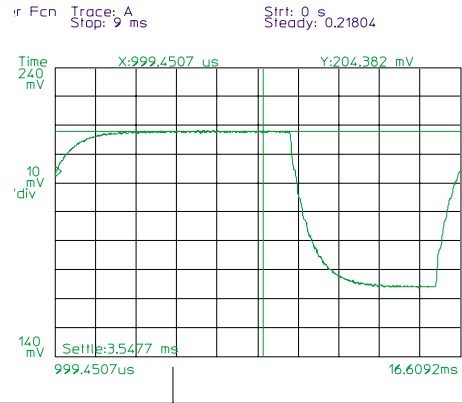
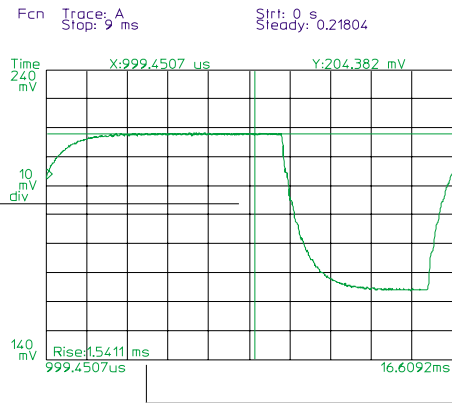

Time parameter value location

Steady-state value

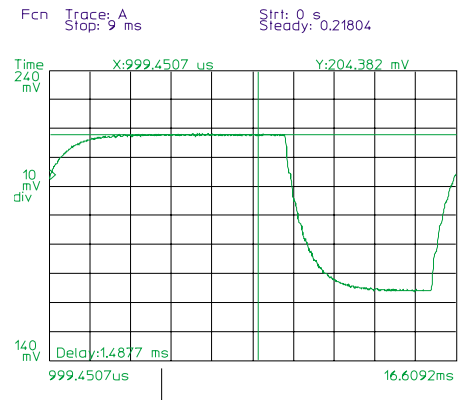
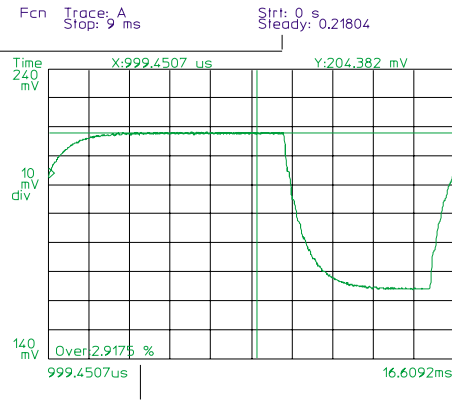

Time parameter value location

Measuring Control System Stability

One of the most fundamental measurement requirements for control systems is measuring loop stability. The Agilent 35670A provides both the traditional swept sine measurements (Option 1D2) and broad band measurement stimulus like chirp and random waveforms for faster production testing. In addition, the internal math capabilities of the Agilent 35670A allow you to easily convert closed loop measurements to open loop responses and correct for phase inversions and frequency response errors found in test fixturing.

A measurement method with minimal overhead is to find the open loop frequency response function using the reference input summing junction. That is, to inject the test stimulus into r and measure points b and e in the figure 5-4. Math is not required. However, if your system is a high-gain (80 dB) analog system this method may not work since e may be so small that it approaches the noise floor of the analyzer.

Figure 5-4.

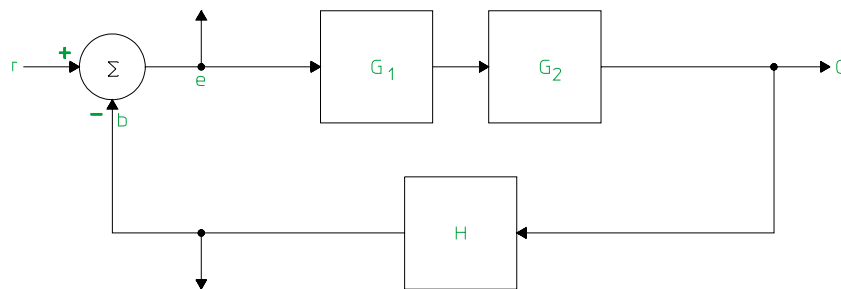

Block Diagram for Open Loop Frequency Responce

Another method is to measure the closed loop frequency response function. A summing junction is used to add a stimulus signal (s) to the loop and the measurement is made at points y and s. See figure 5-5. You then can calculate the open loop frequency response function.

Using the block diagram shown in figure 5-5, we can solve for y/s.

$$y = -yG_1G_2H + sG_1G_2H$$

$$y/s = G_1G_2H / (1 + G_1G_2H)$$

Solving for the open loop response

$$G_1G_2H = (y/s) / (1 - (y/s))$$

To display the open loop transfer function, use the frequency response measurement data to get y/s and then use a math function to calculate the open loop response. It is important to check the measurement results before math operations are performed. The math functions can also be used to “correct” a measurement which contains phase and gain offsets. To check for these gain and phase offset, you need to look at the measured value of y/s. Since $y/s = G_1G_2H / (1 + G_1G_2H)$, we expect to see a gain of 0 dB for lower frequencies, where G_1G_2H is large and the phase should be approaching 0 degrees.

Figure 5-5.

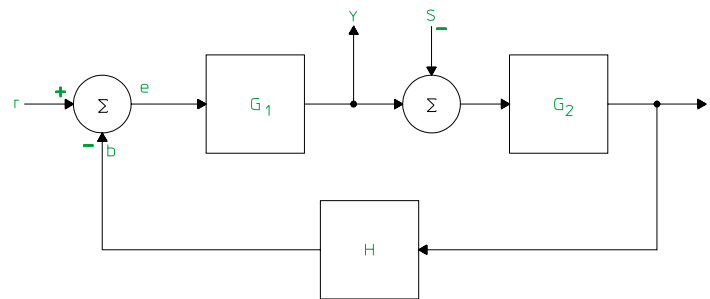

Block Diagram for Closed Loop Frequency

To measure an open loop response

This task uses the reference input summing junction and the controlled output to find the open loop frequency response. The measurement is made in the Swept Sine instrument mode, Option 1D2.

1 Initialize the analyzer.

Press [**Preset**] [DO PRESET].

Press [**Inst Mode**] [SWEPT SINE].

Press [**Meas Data**] [FREQ RESP 2/1].

2 Connect the device-under-test (DUT) as shown in the illustration below.

3 Specify the measurement parameters.

Press [**Freq**] [START] <number> <unit>, then press [STOP] <number> <unit>.

Press [**Input**] [CH1 AUTO RANGE].

Press [CHANNEL 1 2 3 4] to highlight 2, then press [CH2 AUTO RANGE].

Press [**Source**] [LEVEL] <number> <unit>.

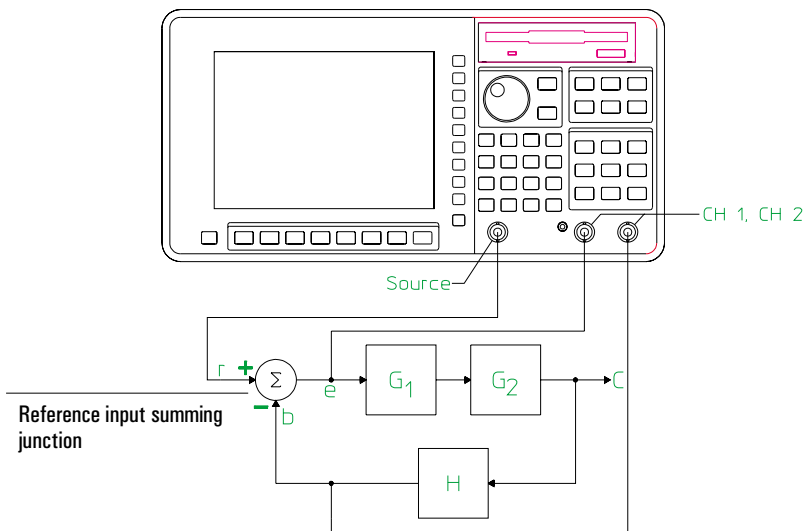

4 Specify the averaging parameters.

Press [**Avg**] [SETTLE TIME] <number> <unit>.
Press [INTEGRATE TIME] <number> <unit>.

5 Configure the display.

Press [**Disp Format**] [MORE] [BODE DIAGRAM].
Press [**Scale**], then press[AUTOSCALE ON OFF] to highlight ON.

6 Measure the DUT.

Press [**Start**].

Use the Agilent 35670A's curve fit feature to see the mathematical model of your data. See chapter 16.

Disp Fomat

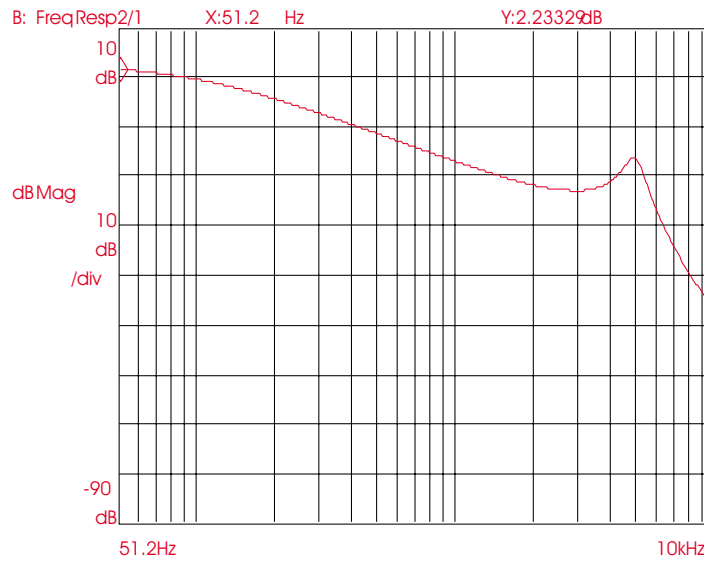
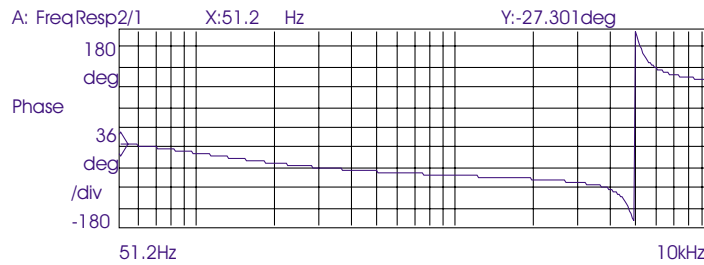

To measure gain and phase margin

- 1 Measure the open loop response.
- 2 Press [Marker Fctn] [GAIN/PHAS MARGINS].
- 3 Press [START FREQUENCY] <number> <unit>.
or
Move the marker to the desired start frequency.
- 4 Press [STOP FREQUENCY] <number> <unit>.
or
Move the marker to the desired stop frequency.
- 5 Press [COMPUTE MARGINS].

Gain margin is the magnitude below 0 dB (gain =1) at the frequency at which phase equals -180° . Phase margin is the phase above -180° at which gain equals 1. Gain crossover is the frequency at which gain equals 1.

The compensator gain will be determined by the gain required to achieve gain crossover at a desired frequency. Gain and Phase values at that frequency will indicate the amount of gain and phase for the compensator design. For example, if the specification is to have a gain-crossover frequency of 265 Hz and a phase margin of $40^\circ \pm 5^\circ$, and the marker measurements show a gain of -9.15 dB and phase of -178° at 265 Hz, the compensator will need 9.15 dB of gain and 38° of phase shift ($180 - 178 = 2$; $40 - 2 = 38$).

Crossover frequency indicated by solid band markers.

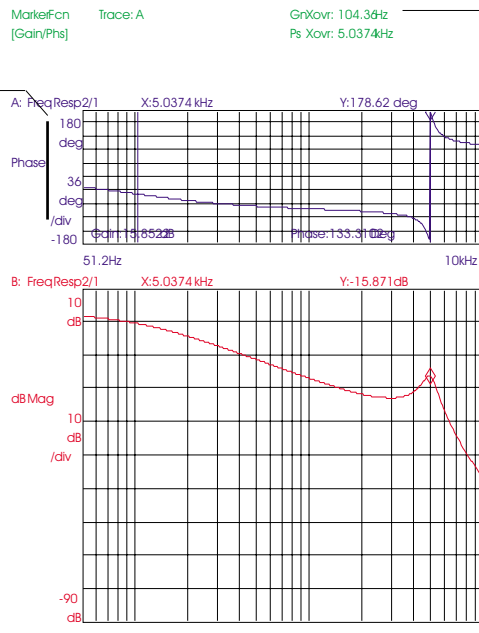

Crossover frequency value appears in mini state.

To display a Nyquist diagram.

- 1 Measure the open loop response.
- 2 Press [**Disp Format**] [SINGLE].
- 3 Press [**Trace Coord**] [MORE CHOICES] [NYQUIST DIAGRAM].
- 4 Press [**Scale**].
Press [AUTOSCALE ON OFF] to highlight ON.
- 5 Press [AXES SCALE MARKERS].
Press [AXIS X Y] to highlight Y.
Press [MOVE CENTER].
Using the knob move the axes scale markers close to the $-1 + j0$ X-axis location.
Press [CHANGE WIDTH].
Using the knob widen the scale markers to include the $-1 + j0$ Y-axis location.
Press [SCALE AT MARKERS].

Stability criteria requires that the open loop response can only cross the negative real axis between the origin and $-1 + j0$. Crossing anywhere else dictates the loop is conditionally stable or unstable.

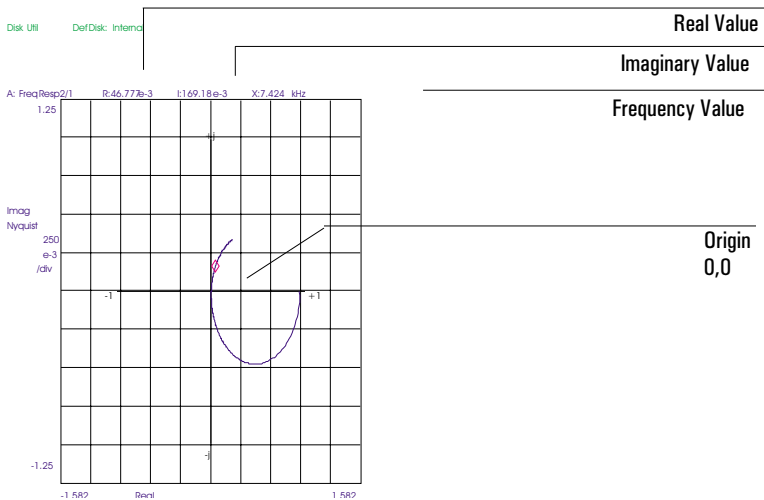

To measure a closed loop response

When it is not possible to make a direct open loop measurement you can make a closed loop response by breaking into the circuit under test and inserting and monitoring the test signals. This task makes a closed loop Y/S measurement in the Swept Sine instrument mode, Option 1D2.

1 Initialize the analyzer.

Press [**Preset**] [DO PRESET].

Press [**Inst Mode**] [SWEPT SINE].

Press [**Meas Data**] [FREQ RESP 2/1].

2 Connect the device-under-test (DUT) as shown in the illustration below.

3 Specify the measurement parameters.

Press [**Freq**] [START] <number> <unit>, then press [STOP] <number> <unit>.

Press [RESOLUTN SETUP], then press [AUTO RES ON OFF] to highlight ON.

Press [**Input**] [CH1 AUTO RANGE].

Press [CHANNEL 1 2 3 4] to highlight 2, then press [CH2 AUTO RANGE].

Press [**Source**] [LEVEL] <number> <unit>.

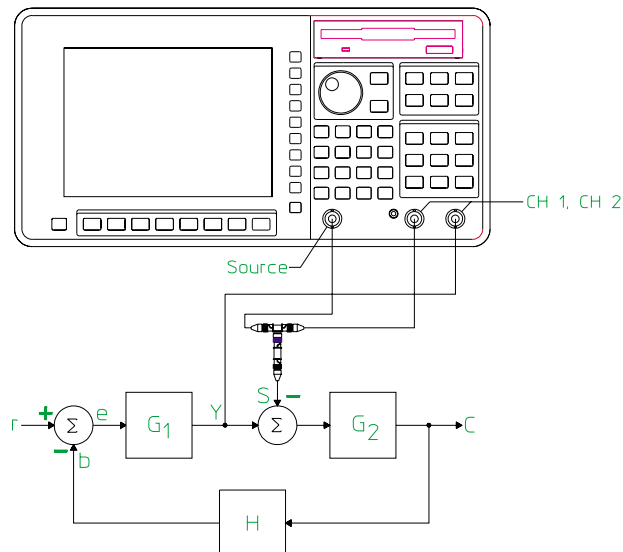

4 Specify the averaging parameters.

Press [**Avg**] [SETTLE TIME] <number> <unit>.
Press [INTEGRATE TIME] <number> <unit>.

5 Configure the display.

Press [**Disp Format**] [MORE] [BODE DIAGRAM].
Press [**Scale**], then press[AUTOSCALE ON OFF] to highlight ON.

6 Measure the DUT.

Press [**Start**].

At low frequencies, the gain of Y/S should be very nearly 1 (0 dB). The phase should be approximately 0°. Make sure to measure Y/S properly. It is easy to inadvertently pick up a 180° phase offset in the measurement results. In addition, gain offsets can be picked up in the measurement. It is important to check the measurement results before performing math operations.

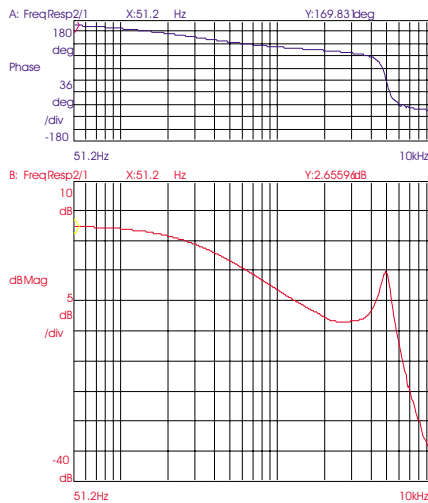

To calculate the open loop response

- 1 Measure the close loop response.
- 2 Press [**Analys**] [DEFINE FUNCTION (F1-F5)] [DEFINE F1].
- 3 Press [MEAS DATA] [FREQ RESP 2/1]
Press [/].
Press [(].
Press [CONSTANT (K1-K5)] [CONSTANT K1].
Press [-].
Press [MEAS DATA] [FREQ RESP 2/1].
- 4 Press [ENTER].
- 5 Press [**Active Trace**] [A B].
Press [**Meas Data**] [MORE CHOICES][MATH FUNCTIO N].
Press [F1].
- 6 Press [**Scale**] [AUTOSCALE ON OFF] to highlight ON.
Press [**Active Trace**] [A].
Press [**Trace Coord**] [PHASE].
Press [**Scale**] [AUTOSCALE ON OFF] to highlight ON.

This task uses the Agilent 35670A's math operations to calculate the closed loop to open loop transfer function, $T/(1-T)$.

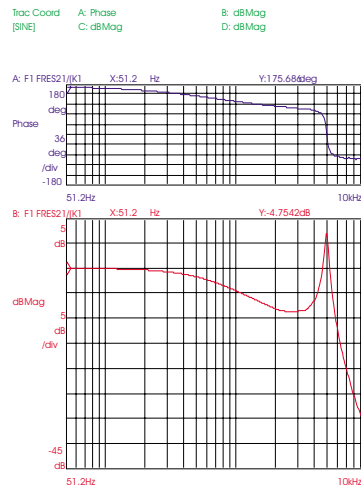

Math function register, F1,
contains closed loop to open loop
transfer function $T/(1-T)$

```
F1 = FRES21/(K1-FRES21)
F2
F3
F4
F5
K1 = 1.000000 + j 0.000000
K2 = 2.000000 + j 0.000000
K3 = -1.000000 + j 0.000000
K4 = 0.000000 + j 1.000000
K5 = 0.000000 - j 1.000000
```

6

The Arbitrary Source Option 1D4

The Arbitrary Source

The analyzer's source can supply a number of different waveforms. The arbitrary source, Option 1D4, provides the flexibility desired for the most accurate characterizations. The analyzer drives the source output with the contents of a data register or the time capture buffer. The register and time capture buffer must contain time domain data. (If you subsequently change the contents of the data register, you must re-configure the source to reflect the new waveform.)

Arbitrary source waveforms are available in FFT analysis, correlation analysis, and histogram analysis instrument modes.

The analyzer scales the data so that its peak voltage corresponds to the current source level in Vpk. With the source on, the analyzer sends the scaled signal to the source connector.

Source Behavior

The repeat feature enables the analyzer to send data to the source connector continuously without interruptions. (The arbitrary source waveform is only one time record long.) When repeat is off, the source behavior is affected by the selected trigger mode.

In free run trigger mode, source output is continuous just as it is with repeat on. For any other trigger mode, the source begins its output only when a trigger occurs and shuts off after all data in the register or time capture buffer has been output. This happens each time a trigger occurs.

A variable low-pass filter is available for the arbitrary source under the [Source] [MORE CHOICES] menus. You can use this filter to remove band power for transfer function measurements using source waveforms containing high frequency edges. See online help for additional information about the arbitrary source filter.

Source Impedance

The analyzer's source impedance is less than 5 ohms. It is designed to be operated into nearly any type of load. If your device-under-test requires a specific source impedance, place an appropriate resistor in series with the analyzer's source output.

Synthesizing Complex Waveforms

You can generate a complex waveform function with a computer program. An example program, "ARBSRC," which generates an arbitrary source waveform is available on the GPIB Example Programs disk. The program listing is printed in Appendix F of *GPIB Programming with the Agilent 35670A*.

To create a step signal

This task builds a step source signal which can be used for control loop performance characterization.

1 Initialize the analyzer.

Press [**Preset**] [DO PRESET].

2 Connect the source to the Channel 1 input as shown in the illustration.

Press [**Source**] [LEVEL] <number> <unit>.

Press [SOURCE ON OFF] to highlight ON.

3 Display a waveform.

Press [**Freq**] [RECORD LENGTH], then press [**1**] [**5**] [mS].

Press [**Meas Data**] [TIME CHANNEL 1].

Press [**Pause-Cont**].

Press [**Save/Recall**] [SAVE DATA] [SAVE TRACE] [INTO D1].

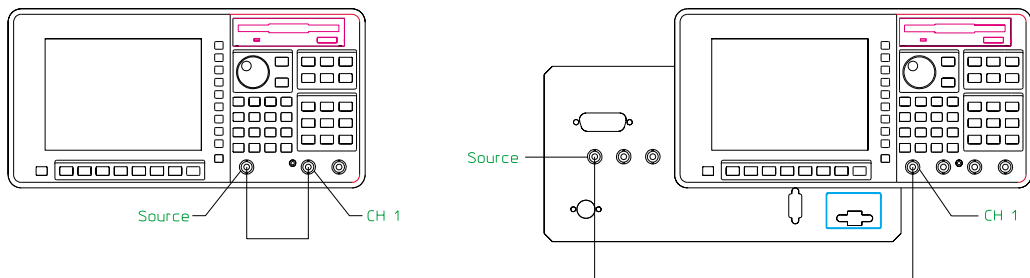

4 Modify the waveform.

Press [**Analys**] [DATA EDIT] [EDIT D1].
Press [MODIFY START Y] [1] [ENTER].
Press [MODIFY STOP Y] [1] [ENTER].
Press [START X] [1] [0] [mS].
Press [MODIFY START Y] [0] [ENTER].
Press [MODIFY STOP Y] [0] [ENTER].

5 Configure the display.

Press [**Scale**], then press[AUTOSCALE ON OFF] to highlight ON.

6 Configure the arbitrary source.

Press [**Source**] [MORE CHOICES] [ARB SRC SETUP] [DATA REG D1].
Press [**Rtn**].
Press [ARBITRARY (D1 - D8)].

The analyzer defaults to the nearest time record length, in this case 15.625 mS.

To build a different type of step signal, simply replace the start and stop values for the X- and Y-axis in step 6 with your own.

Start X = 0
Start Y, Stop Y = 10

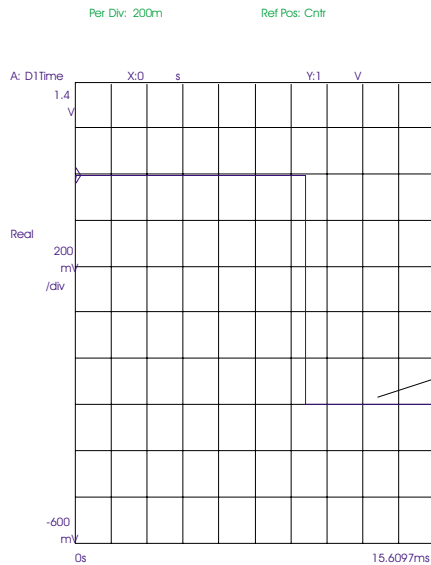

Start X = 10
Start Y, Stop Y = 0

To create a ramp signal

This task builds a ramp waveform.

1 Initialize the analyzer.

Press [**Preset**] [DO PRESET].

2 Connect the source to the Channel 1 input as shown in the illustration.

Press [**Source**] [LEVEL] <number> <unit>.

Press [SOURCE ON OFF] to highlight ON.

3 Display a waveform.

Press [**Freq**] [RECORD LENGTH], then press [1] [5] [mS].

Press [**Meas Data**] [TIME CHANNEL 1].

Press [**Pause-Cont**].

Press [**Save/Recall**] [SAVE DATA] [SAVE TRACE] [INTO D1].

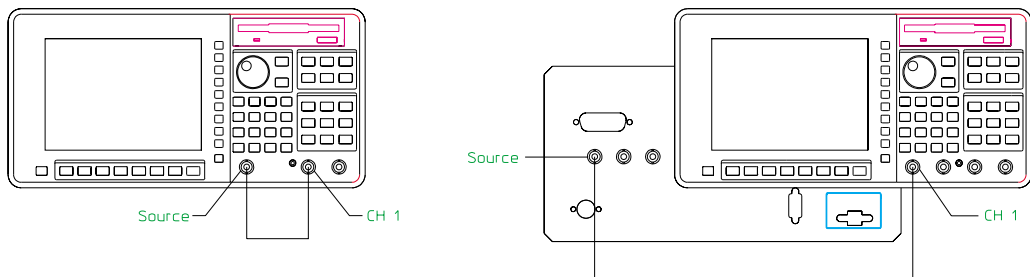

4 Modify the waveform.

Press [**Analys**] [DATA EDIT] [EDIT D1].
Press [MODIFY START Y] [0] [ENTER].
Press [MODIFY STOP Y] [0] [ENTER].
Press [START X] [5] [mS].
Press [STOP X] [1] [0] [mS].
Press [MODIFY START Y] [0] [ENTER].
Press [MODIFY STOP Y] [1] [ENTER].

5 Configure the display.

Press [**Scale**], then press[AUTOSCALE ON OFF] to highlight ON.

6 Configure the arbitrary source.

Press [**Source**] [ARB SRC SETUP] [DATA REG D1].
Press [**Rtn**].
Press [ARBITRARY (D1 - D8)].

To ensure more accurate results by avoiding residual noise, the region outside of the ramp is zeroed out in step 4.

To build a different type of ramp signal, simply replace the start and stop values for the X- and Y-axis in step 4 with your own.

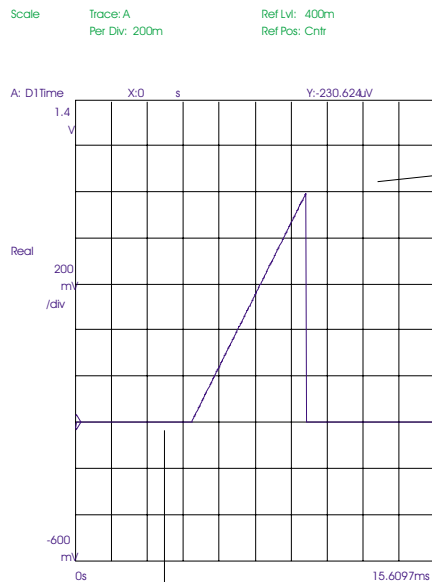

Stop X = 10ms
Stop Y = 1

Start X = 5ms
Start Y = 0

To create a profiled chirp waveform

This task builds a profiled chirp waveform by using the analyzer's mathematics capability.

1 Initialize the analyzer.

Press [**Preset**] [DO PRESET].

2 Connect the source to the Channel 1 input as shown in the illustration.

3 Build a ramp signal and store it in data register D1. See the previous task.

4 Display a periodic chirp waveform.

Press [**Meas Data**] [TIME CHANNEL 1].

press [**Source**] [PERIODIC CHIRP] [LEVEL] [1] [V_{pk}].

Press [SOURCE ON OFF] to highlight ON.

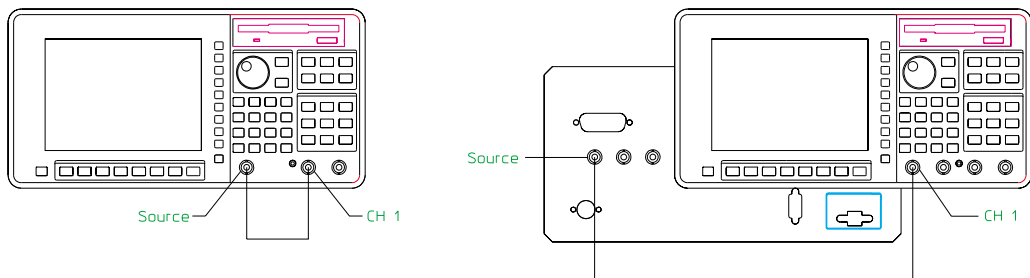

5 Modify the waveform.

Press [**Analys**] [DEFINE FUNCTION (F1-F5)].
 Press [DEFINE F1] [MEAS DATA].
 Press [CHANNEL 1 2 3 4] to highlight 1.
 Press [TIME CHANNEL 1].
 Press [*].
 Press [DATA REGISTER (D1 - D8)] [DATA REG D1].
 Press [ENTER].

6 Configure the display.

Press [**Meas Data**] [MORE CHOICES] [MATH FUNCTION] [F1].
 Press [**Trace Coord**] [MORE CHOICES] [REAL PART].
 Press [**Scale**], then press[AUTOSCALE ON OFF] to highlight ON.

7 Configure the arbitrary source.

Press [**Save/Recall**] [SAVE DATA] [SAVE TRACE] [INTO D2].
 Press [**Source**] [MORE CHOICES] [ARB SRC SETUP] [DATA REG D2].
 Press [**Rtn**].
 Press [ARBITRARY (D1 - D8)].

This task uses a ramp signal as a weighting function for the periodic chirp waveform.
 Step 5 specifies a math function that does the multiplication and stores the result.

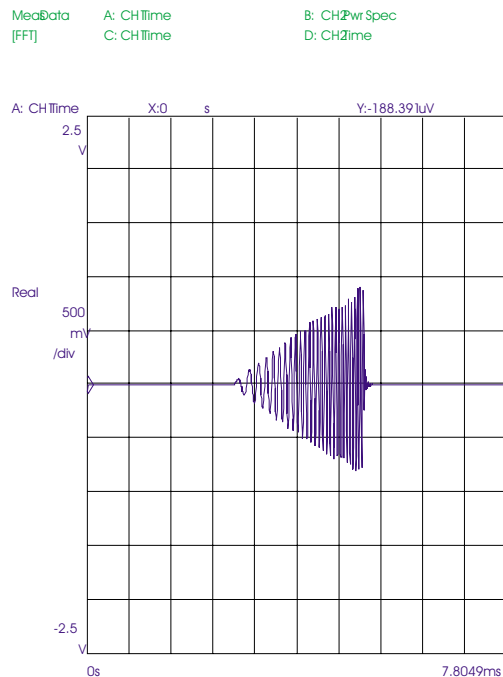

```
F1 = Time1 * D1
F2
F3
F4
F5
K1 = 1.000000 + j 0.000000
K2 = 2.000000 + j 0.000000
K3 = -1.000000 + j 0.000000
K4 = 0.000000 + j 1.000000
K5 = 0.000000 - j 1.000000
```

Using Time Capture

Time capture allows you to fill a buffer with input data and then measure from that buffer at a later time. This chapter shows you how to fill and measure from the buffer.

To prepare for filling the capture buffer

Preparing to fill the time-capture buffer is very similar to preparing for any other measurement: You must complete all your connections between the analyzer and your device-under-test (DUT), and you must specify most parameters grouped under the MEASUREMENT hardkeys. However, you must not rely on autoranging to maintain the proper range for your input channels. The analyzer does not autorange while it is filling the buffer.

- 1 Initialize the analyzer and connect your test signals (as described in other measurement tasks), just as you would if you were not capturing data.
- 2 Manually set each channel's range to slightly exceed the highest signal level you anticipate.
Press [**Input**] then press [CHANNEL 1 2] (or [CHANNEL 1 2 3 4]) to select the channel whose range you will set.
Press [CHANNEL x RANGE] <number> [ENTER].
Repeat this step for each active channel.
- 3 Specify the other [**Input**] parameters, and the parameters grouped under [**Freq**] and [**Source**], just as you would if you were not capturing data.
- 4 If you will require tachometer data when you measure from the buffer (as you will when you measure using the order instrument mode or rpm-step arming), press [**Input**] [TACHOMETR SETUP], then specify the tachometer parameters.
- 5 If you will require tachometer data when you measure from the buffer, but you are *not* using the order instrument mode to fill the buffer, enable the collection of tachometer data.
Press [**Inst Mode**] [TIME CAPTURE] [TACHOMETR OPTIONS], then press [TACH DATA ON OFF] to highlight ON.
Press [MAX RPM] <number> [ENTER] to specify the highest rotation speed you will monitor when you measure from the buffer.

- 6 If you want to trigger the start of data collection, set up triggering.
Press [**Trigger**], then press the softkey corresponding to the trigger type you want to use.
Press [TRIGGER SETUP], then specify the triggering parameters.
- 7 If you will display phase information when you measure from the buffer using the order instrument mode, you must enable external triggering.
Press [**Trigger**] [EXTERNAL TRIGGER].
Press [TRIGGER SETUP], then set up the external trigger parameters.

In most cases, the Agilent 35670A allows you to measure from the time-capture buffer using any instrument mode—regardless of the mode you used to fill it. There are three exceptions:

- You can neither fill nor measure from the buffer using the swept sine mode.
- If you fill the buffer using FFT mode and a start frequency greater than 0 Hz (which provides “zoomed” data), you can measure from the buffer only if the FFT mode is selected.
- If you fill the buffer without including tachometer data, you cannot measure from the buffer using order mode.

Although these are the only cases where it is not possible to change instrument modes when you measure from the buffer, it is generally better to fill and measure from the buffer using the same mode.

Step 4 is not required when you fill the time-capture buffer using the order instrument mode. Tachometer data is always included in the buffer when you fill it with the order mode selected. (And the [MAX RPM] value is taken directly from the [**Freq**] menu.)

To allocate memory for the capture buffer

- 1 Set up measurement parameters, as described in the previous task.
- 2 Press [**Inst Mode**] [TIME CAPTURE] [BUFFER LENGTH], then enter the amount of time data you want to capture (in seconds, blocks, or points).
- 3 Press [ALLOCATE BUFFER] [CONFIRM ALLOCATE].

The size of the time-capture buffer is affected by the value of [BUFFER LENGTH] and several measurement setup parameters. If the buffer required for the current setup is too big to fit in the available memory, the analyzer automatically reduces the value of [BUFFER LENGTH] until the buffer just fits. A message is displayed to let you know that the buffer length has been reduced. If you see this message, press [**System Utility**] [MEMORY USAGE] to see if you can free additional memory for the buffer.

If you forget to press [ALLOCATE BUFFER] before you begin filling the time-capture buffer, the analyzer automatically performs an equivalent operation when you press [FILL BUFFER]. However, it is generally better to use [ALLOCATE BUFFER]: This will minimize the delay between pressing [FILL BUFFER] and the beginning of data collection.

To fill the capture buffer

- 1 Set up the measurement parameters and allocate memory for the buffer, as described in the previous two tasks.
- 2 Press [**Inst Mode**] [TIME CAPTURE] [FILL BUFFER].

When you press [FILL BUFFER] the analyzer collects data from all active input channels and places it in the time-capture buffer. The analyzer also collects tachometer and external trigger data if the setup you defined in “To prepare for filling the capture buffer” requires it. Data collection stops automatically when the buffer is full or when you press [ABORT FILL].

To save the capture buffer on a flexible disk

- 1 Press [**Inst Mode**] [TIME CAPTURE], press [BUFR INFO ON OFF] to highlight on, then read the value of “Size” to determine how much disk space is required.
- 2 Format enough double-sided, 3.5-inch flexible disks to save the entire time-capture buffer.
- 3 Insert one of the formatted disks in the analyzer’s internal disk drive.
- 4 If you have not already designated the internal disk as the default disk, press [**Save/Recall**] [DEFAULT DISK] [INTERNAL DISK].
- 5 Press [**Save/Recall**] [SAVE DATA] [SAVE CAPTURE], type a file name, then press [ENTER].
- 6 If analyzer informs you that the buffer must be split, press [CONTINUE SAVE].
- 7 If the analyzer instructs you to insert another disk, insert a disk and then press [CONTINUE SAVE].

When the analyzer must split the buffer and save it on more than one disk, it modifies the file name you entered in step 5. The file is named <filename>_1.<extension> on the first disk, <filename>_2.<extension> on the second, <filename>_3.<extension> on the third, and so on. If <filename> already contains the maximum number of characters, the analyzer replaces the last two characters with the “_x” characters. For example, if you entered the name WINGTEST.DAT in step 5 and the buffer needed to be saved on two DOS-formatted disks, the two files would be named WINGTE_1.DAT and WINGTE_2.DAT.

If you don’t know how to format disks, see chapter 13, “Managing Files and Disks.”

To recall a capture buffer from a flexible disk

- 1 If the saved time-capture buffer was saved on a single disk, insert that disk in the analyzer's internal disk drive.
or
If the saved buffer was split and saved on several disks, insert the disk containing the first part of the buffer.
- 2 If you have not already designated the internal disk as the default disk, press [Save/Recall] [DEFAULT DISK] [INTERNAL DISK].
- 3 Press [Save/Recall] [RECALL DATA] [RECALL CAPTURE], type the name of the file containing the saved buffer, then press [ENTER].
- 4 If you are recalling a split buffer, insert another disk and press [CONTINUE RECALL] when the analyzer instructs you to do so.

If the recalled time-capture buffer is too big to fit in the available memory, the recall operation is aborted. You can sometimes make more memory available for the capture buffer by removing other items from memory. You do this with softkeys grouped under [System Utility] [MEMORY USAGE].

To examine the capture buffer

- 1 Activate the trace you will use to view one channel of the time-capture buffer.
- 2 Press [Meas Data], then press [CHANNEL 1 2] or [CHANNEL 1 2 3 4] to highlight the channel of captured data you want to view.
- 3 If the FFT instrument mode is selected, press [MORE CHOICES] [CAPTURE CHANNEL x].
or
If any other instrument mode is selected, just press [CAPTURE CHANNEL x].
- 4 Press [Scale], then press [AUTOSCALE ON OFF] to highlight ON.
- 5 Press [AXES SCAL MARKERS], then press [AXIS X Y] to highlight X.
- 6 Use the knob along with the MOVE and WIDTH softkeys to define the region you want to examine, then press [SCALE AT MARKERS] to expand that region so it fills the X-axis.
- 7 If you want to scroll through the expanded X-axis data, press [MOVE CENTER] and turn the knob.

The analyzer allows you to measure from the entire time-capture buffer or from a selected region of the buffer. The X-axis scale markers help you select a measurement region by allowing you to take a closer look at each channel of the buffer. Once you've taken a closer look, you can again display all data from the selected channel by pressing [FULL SCALE]. You are now ready to define the analysis region (as described in the following task).

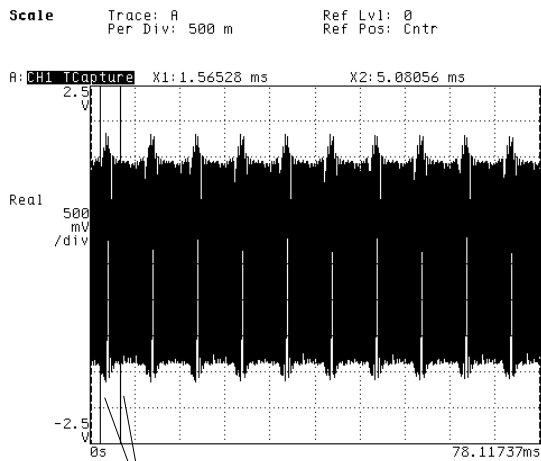

X-axis scale markers select the region you want to examine.

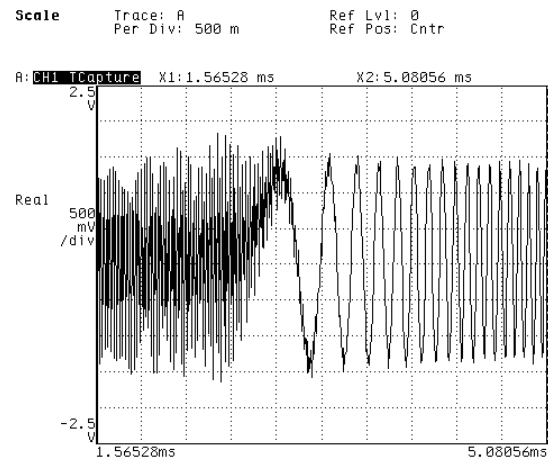

[SCALE AT MARKERS] expands the selected region to fill the X-axis.

To define an analysis region

- 1 Examine each channel of the time-capture buffer (as described in the previous task) to decide which region you want to analyze.
- 2 Press [**Active Trace**], then press [A] if the capture buffer contains data from one channel, [A B] if it contains data from two, or [A B C D] if it contains data from four.
- 3 If the FFT instrument mode is selected, press [**Meas Data**] [ALL CHANNELS] [MORE CHOICES] [CAPTURE CHANNEL *].
or
If any other instrument mode is selected, [**Meas Data**] [ALL CHANNELS] [CAPTURE CHANNEL *].
- 4 Press [**Scale**], then press [AUTOSCALE ON OFF] to highlight ON.
- 5 Press [AXES SCAL MARKERS], press [AXIS X Y] to highlight X, then press [FULL SCALE].
- 6 Press [**Inst Mode**] [TIME CAPTURE] [ANALYSIS REGION] [ALL CHANNELS].
- 7 Press [STRT TIME CHANNEL *] <number> [S], then press [STOP TIME CHANNEL *] <number> [S] to define the beginning and end of the analysis region.

If you prefer, you can set an independent analysis region for each channel in the capture buffer. In steps 3 and 6, just press [CHANNEL 1 2] (or [CHANNEL 1 2 3 4]) to highlight the channel whose analysis region you want to define. Setting independent regions allows you to measure with greater delays between channels than are possible when you measure directly from the inputs using trigger delays. There is one important restriction on independent analysis regions: If you specify regions of different lengths for different channels, the analyzer stops measuring when all the data has been taken from the shortest region.

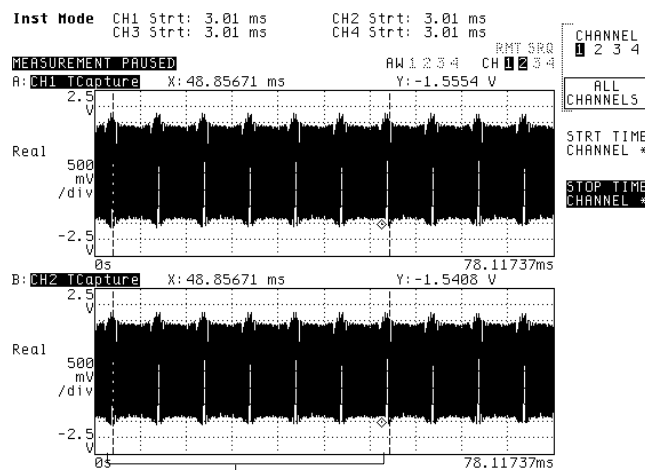

The analyzer will measure from this region of the capture buffer.

To prepare for measuring from the capture buffer

When you measure from the time-capture buffer, the analyzer processes the raw input data stored in the buffer to provide the various types of measurement data available under the **[Meas Data]** hardkey. Preparing to measure from the capture buffer involves specifying those measurement parameters that affect how the input data is processed.

1 Initialize the analyzer.

Press **[Preset]** [DO PRESET].

Press **[Inst Mode]**, then press the softkey corresponding to the instrument mode you want to use.

Press **[CHANNELS 1 2]** (or **[CHANNELS 1 2 4]**) to highlight the number of channels whose data was stored in the buffer.

If the capture buffer contains input data from four channels, press **[REF CHANS 1 1,3]** to select the reference channel (or channels).

2 Specify the measurement parameters.

Press **[Freq]**, then specify the frequency parameters or time-record length.

If you selected the FFT, order, or correlation instrument mode, press **[Window]**, then specify the windowing parameters.

3 Specify the triggering and averaging parameters.

Press **[Trigger]** [ARM SETUP], then specify the arming parameters.

If you selected the order instrument mode and want to display phase information, press **[Trigger]** [EXTERNAL TRIGGER].

Press **[Avg]**, then specify the averaging parameters.

4 Configure the display.

Activate all the traces you will use to display measurement results.

Press [**Scale**], then press [AUTOSCALE ON OFF] to highlight ON.

Activate a single trace, then press [**Meas Data**] followed by the softkey corresponding to the measurement results you want to display in that trace.

If you want to watch the measurement progress through the data in the time-capture buffer, activate a single trace, then press [**Meas Data**] [CAPTURE CHANNEL x] (or [**Meas Data**] [MORE CHOICES] [CAPTURE CHANNEL x]).

In most cases, the Agilent 35670A allows you to measure from the time-capture buffer using any instrument mode—regardless of the mode you used to fill it. There are three exceptions:

- You can neither fill nor measure from the buffer using the swept sine mode.
- If you filled the buffer using FFT mode and a start frequency greater than 0 Hz (which provides “zoomed” data), you can measure from the buffer only if the FFT mode is selected.
- If you filled the buffer without including tachometer data, you cannot measure from the buffer using order mode.

Although these are the only cases where it is not possible to change instrument modes when you measure from the buffer, it is generally better to fill and measure from the buffer using the same mode.

The analyzer also allows you to measure from the time-capture buffer using a narrower frequency span or longer time record than was used to fill the buffer. The only exception is if you filled the buffer with zoomed data (as described above). The analyzer *never* allows you to measure from the buffer using a wider span or shorter time record than was used to fill the buffer. This restriction is enforced when you press [**Start**] to begin measuring from the buffer.

To measure from the capture buffer

- 1 Prepare the analyzer to measure from the time-capture buffer, as described in the previous task.
- 2 Press **[Inst Mode]** [TIME CAPTURE], then press **[MEAS FROM INP BUFR]** to highlight BUFR.
- 3 Press the **[Start]** hardkey to begin measuring.

You can watch the measurement progress through the data in the time-capture buffer if you displayed a channel of the buffer in the previous task. A measurement marker moves through the displayed data as the measurement progresses.

Remember to set **[MEAS FROM INP BUFR]** back to INP when you want to measure directly from the input channels.

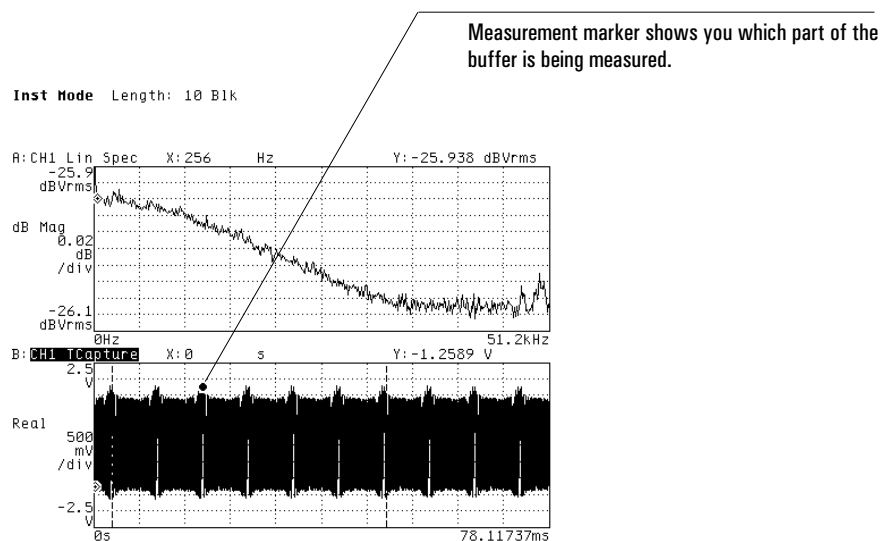

8

Displaying Measurement Data

This chapter shows you how to control the number of active traces. It also shows you how to display several different types of measurement data in the traces.

To select the active trace

- 1 Press [Active Trace].
- 2 If you want to activate a single trace, press one of the following softkeys: [A], [B], [C], or [D].
- 3 If you want to activate two traces at once, press one of the following softkeys: [A B] or [C D].
- 4 If you want to activate all four traces at once, press [A B C D].

The analyzer has four trace buffers that are *independent* of the input channels: trace A, trace B, trace C, and trace D. The Active Trace menu lets you activate these buffers so you can modify them separately or in groups—using softkeys under the [Meas Data], [Trace Coord], [Scale], [Marker], and [Marker Fctn] hardkeys. The menu is only displayed temporarily: after you press one of its softkeys (or the [Rtn] hardkey), the analyzer redisplay the previous menu.

Some operations can only act on a single trace—even when multiple traces are active. For example, the [SAVE TRACE] softkey can only be used to save a single trace. Operations like this act on the “most active” trace if multiple traces are active:

- Trace A is the most active when you select [A B] or [A B C D].
- Trace C is the most active when you select [C D].

Titles for active traces are highlighted.

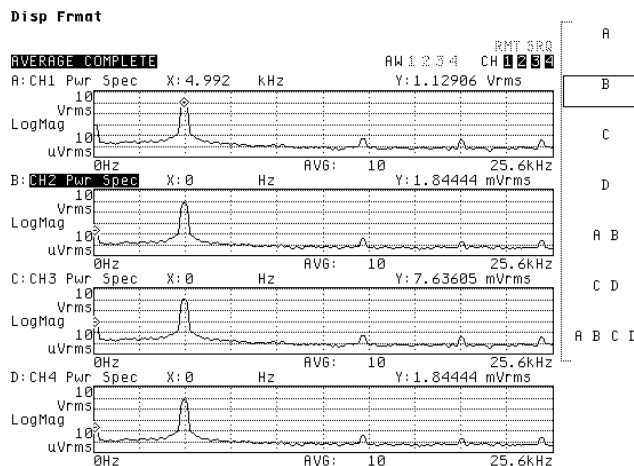

In the Active Trace menu, a box surrounds the softkey selecting the active traces.

To display measurement data—one channel, one trace

- 1 Activate a single trace.
- 2 Press [**Meas Data**], then press [CHANNEL 1 2] (or [CHANNEL 1 2 3 4]) to highlight the channel whose data you want to display.
- 3 Press the softkey corresponding to the measurement data you want to display.

Settings under the [**Inst Mode**] hardkey control the availability of measurement data:

- The instrument mode selection. Not all measurement data is available for every instrument mode. Autocorrelation data, for example, is available only when [CORRELATN ANALYSIS] is selected.
- The [CHANNELS 1 2] (or [CHANNELS 1 2 4]) setting. Some measurement data—for example, frequency response—requires data from two channels. This type of measurement data is available only if the active channels softkey is set to 2 or 4.
- The [REF CHANS 1 1,3] setting (four-channel analyzers only). Measurement data that requires two channels and uses channel 3 as the reference for channel 4, is available only when the reference channels softkey is set to 1,3.

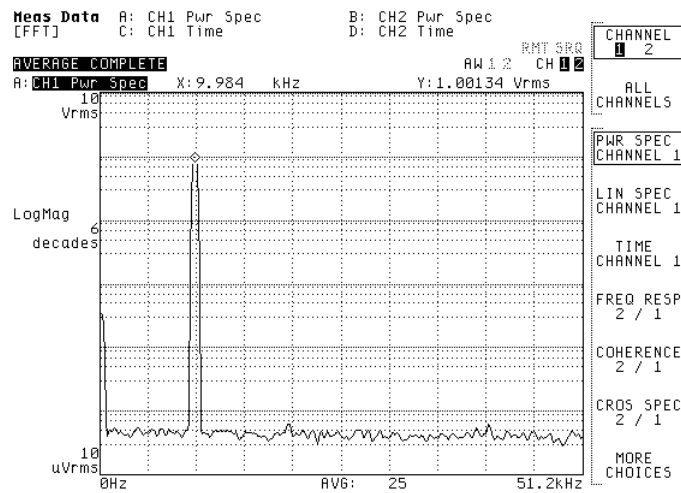

To display measurement data—one channel, multiple traces

- 1 Activate the traces you will use to display the same measurement data.
- 2 Press [Meas Data], then press [CHANNEL 1 2] (or [CHANNEL 1 2 3 4]) to highlight the channel whose data you want to display.
- 3 Press the softkey corresponding to the measurement data you want to display.

Sometimes you will want to view the same measurement data in two or more coordinate systems simultaneously. For example, you might want to view frequency response data using both magnitude vs. frequency and phase vs. frequency. When you complete this task, the same data is displayed in multiple traces. You can then activate the traces separately, selecting a different coordinate system for each (under the [Trace Coord] hardkey).

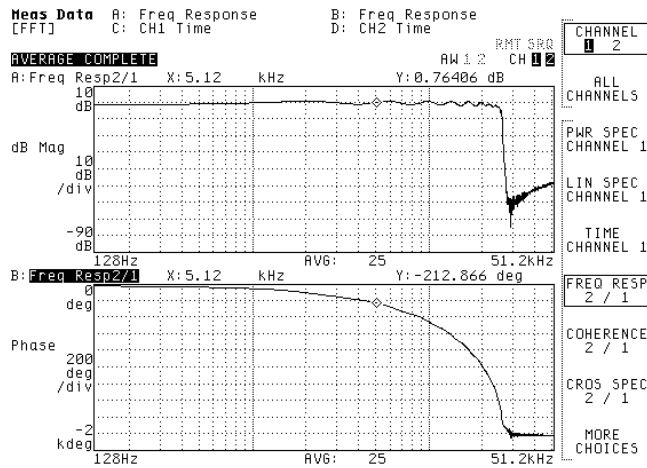

Both traces contain the same frequency response data. Trace A displays the data using magnitude versus frequency. Trace B displays the data using phase versus frequency.

To display measurement data—multiple channels, multiple traces

- 1 If you want to display data from two channels at once, activate two traces.
- 2 If you want to display data from four channels at once (Option AY6 only), activate all four traces.
- 3 Press **[Meas Data]** **[ALL CHANNELS]**.
- 4 Press the softkey corresponding to the type of measurement data you want to display.

Sometimes you will want to view the same measurement data from different channels simultaneously. For example, you might want to view time data for from channels 1 and 2 at the same time. When you complete this task, the same *type* of data is displayed in all of the active traces, but each trace's data is measured by a different channel.

You can display data from a particular channel only if that channel is active. You control the number of active channels under the **[Inst Mode]** hardkey—using the **[CHANNELS 1 2]** (or **[CHANNELS 1 2 4]**) softkey.

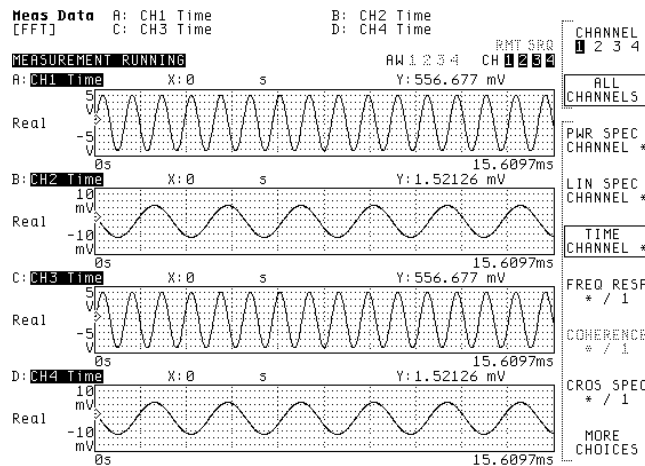

Each of the four traces displays time data from a different channel.

To display a data register

- 1 Activate the trace you will use to display the data register.
- 2 If the octave analysis mode is selected, press [**Meas Data**] [DATA REGISTER].
- 3 If any other instrument mode is selected, press [**Meas Data**] [MORE CHOICES] [DATA REGISTER].
- 4 Press the [D_x] softkey corresponding to the data register you want to display.

The analyzer's eight data registers allow you to display saved measurement data. You can load a data register in one of two ways:

- by saving a trace from the current measurement directly into a data register
- by recalling a trace from a file into a data register

Register title includes the first 10 characters of the title saved with the trace.

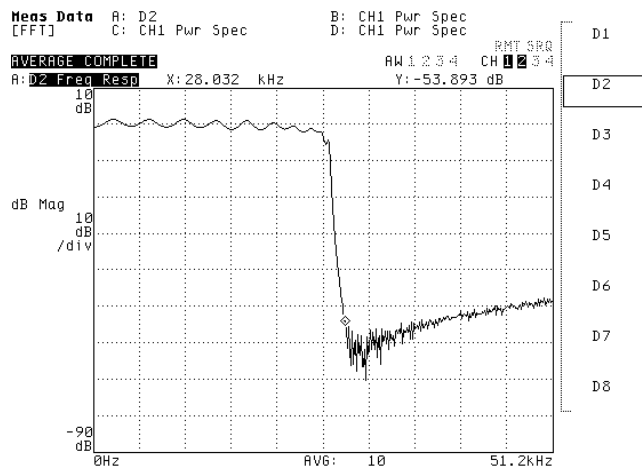

To display a math function

- 1 Activate the trace you will use to display the math function.
- 2 If the octave analysis mode is selected, press **[Meas Data]** **[MATH FUNCTION]**.
- 3 If any other instrument mode is selected, press **[Meas Data]** **[MORE CHOICES]** **[MATH FUNCTION]**.
- 4 Press the **[F_x]** softkey corresponding to the math function you want to display.

The analyzer does not allow you to display the results of a math function if it requires measurement data that is not available with the current setup. Suppose the math function F1 requires histogram data, which is only available when the histogram/time mode is selected. The **[F1]** softkey would be unavailable when any other instrument mode was selected. The analyzer would indicate this by displaying **[F1]** with a dimmer (ghosted) font.

For more information on defining a math function, see chapter 18, “Math Functions and Data Editing.”

Trace title includes the first 10 characters of the math definition.

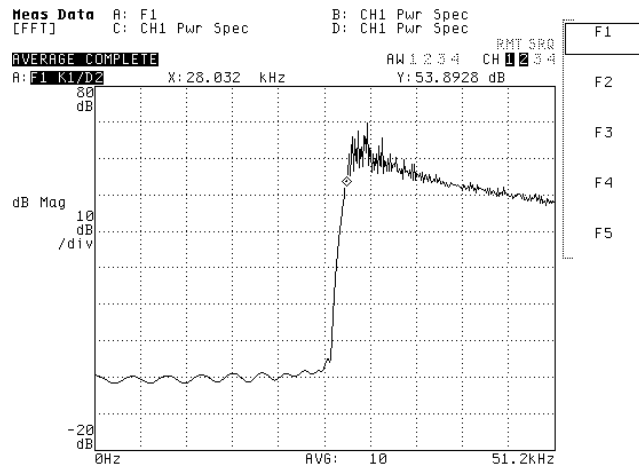

In the example here, the math function inverted the contents of the data register.

9

Formatting the Display

This first half of this chapter shows you how to modify a wide range of general display parameters. The second half shows you how to work with a waterfall display.

To arrange traces on the screen

- 1 Press [Disp Format].
- 2 If you want to display a single trace, press [SINGLE].
- 3 If you want to display two traces at once, press one of the following softkeys: [SINGLE FRNT/BACK], [UPPER/LOWER], or [UPPER/BIG LOWER].
- 4 If you want to display all four traces at once, press one of the following softkeys: [UPPR/LOWR FRNT/BACK] or [QUAD].

When you select one of the two-trace formats, the selection you make under [Active Trace] determines not only which traces are active, but also which pair of traces is displayed. If you press [A], [B], or [A B], the analyzer displays traces A and B. If you press [C], [D], or [C D] it displays traces C and D.

When you select [SINGLE FRNT/BACK], the selected pair of traces is displayed in the same trace area. Each element of the trace annotation is stacked: A on top, B on the bottom; or C on top, D on the bottom. When you select [UPPR/LOWR FRNT/BACK], traces A and B are displayed in the upper trace area, and traces C and D are displayed in the lower trace area. Annotation in each area is stacked.

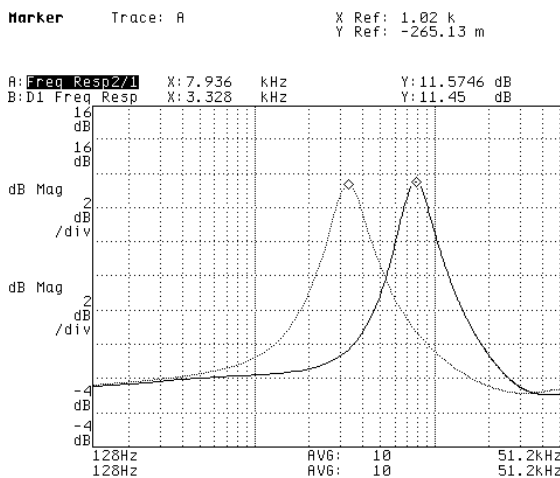

[SINGLE FRNT/BACK] is good for comparing two traces.

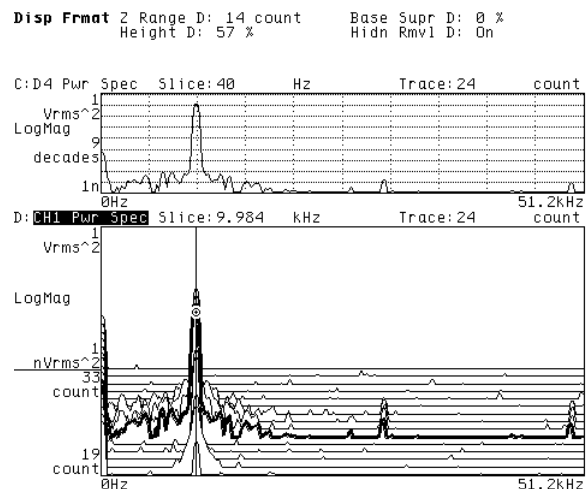

[UPPER/BIG LOWER] is good for waterfall displays.

To enable global screen elements

- 1 If you want to display the tachometer readout, press [**Disp Format**] [MORE], then press [TACH DISP ON OFF] to highlight ON.
- 2 If you want to display X- and Y-axis annotation, press [**Disp Format**] [MORE] [MORE], then press [ANNOTATN ON OFF] to highlight ON.

The tachometer readout shows you the frequency of the signal connected to the TACH input on the analyzer's rear panel. It is always on for order-mode measurements and measurements that use rpm-step arming, regardless of the [TACH DISP ON OFF] setting.

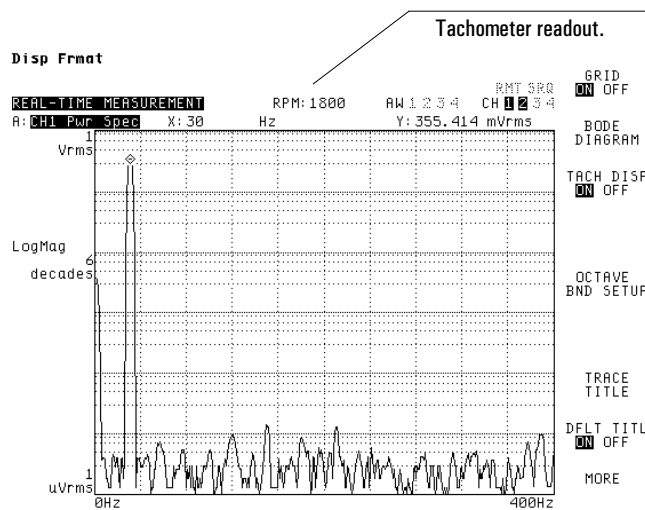

The shaded area shows the location of the X- and Y-axis annotation.

To enable trace-specific screen elements

- 1 Activate the trace you want to modify.
- 2 If you want to display the trace grid, press [**Disp Format**] [MORE], then press [GRID ON OFF] to highlight ON.
- 3 If you want to display the overall SPL band for octave-mode measurements, press [**Disp Format**] [MORE] [OCTAVE BND SETUP], then press [OVERALL ON OFF] to highlight ON.
- 4 If you want to display the A-weighted overall SPL band for octave-mode measurements, press [**Disp Format**] [MORE] [OCTAVE BND SETUP], then press [WEIGHTED ON OFF] to highlight ON.
- 5 If you want to display the marker readout, press [**Marker**], then press [MARKER ON OFF] to highlight ON.

If the trace grid is turned off, it will not be displayed on the screen and it will not be plotted or printed. If the marker readout is not displayed when you set [MARKER ON OFF] to ON, check to be sure that X-and Y-axis annotation is enabled for the entire screen: the previous task shows you how.

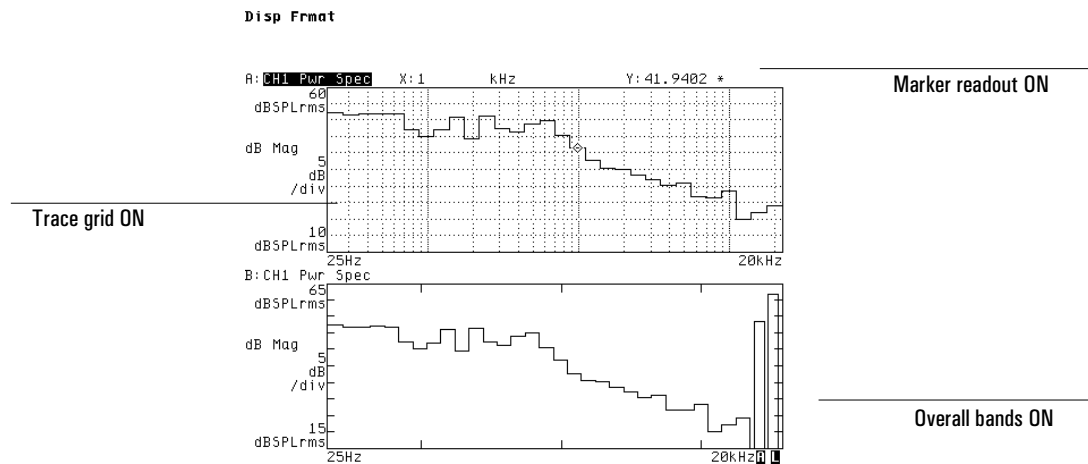

To enter your own trace title

- 1 Activate the trace you want to create a title for.
- 2 Press [**Disp Format**] [**MORE**] [**TRACE TITLE**].
- 3 Type a title and press [**ENTER**].

You can enter a title that is up to 13 characters long. When you press [**ENTER**], the analyzer automatically sets the state of [**DFLT TITL ON OFF**] (the softkey below [**TRACE TITLE**]) to **OFF**. This ensures that the title you enter will replace the default title at the upper-left corner of the trace.

The title you enter labels the active trace buffer, *not* the measurement data that's being displayed in that buffer. For example, if you create a title for trace A, the title does not change when you select a new softkey under [**Meas Data**]. However, if you save the measurement data, the trace title is saved with it. When you recall the saved data into a data register, the title that was saved with it is included as part of the register's default title.

The trace title can be up to 13 characters.

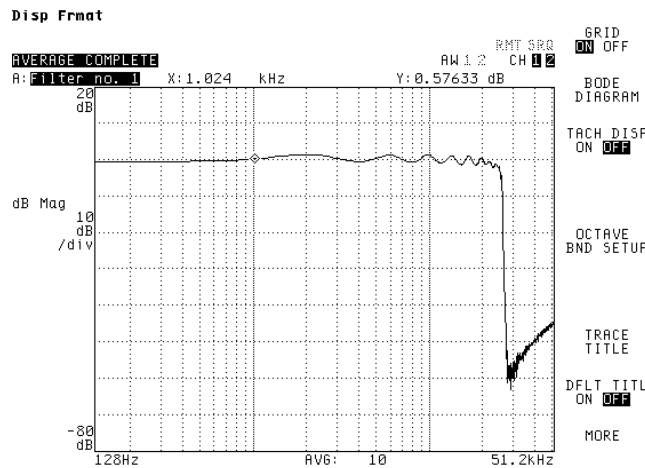

The default title is set to OFF when you enter a new title.

To control the screen

- 1 Press [**Disp Format**] [MORE] [MORE].
- 2 If you want to modify screen brightness, press [DISPLAY BRIGHTNES], then press the up and down arrow keys.
- 3 If you want to enable output to an external monitor (via the EXT MONITOR port on the rear panel), press [EXT DISP ON OFF] to highlight ON.
- 4 If you want the screen to be turned off automatically after the front panel has been idle for a specified amount of time, press [SCREEN SAVER ON], then press [SAVER TIME] <number> [MINUTE] to specify the idle time.
- 5 If you want to turn off the screen now, press [DISPLAY ON OFF] to highlight OFF.

When you enable output to an external monitor, the brightness setting does not affect the analyzer's screen. When the screen has been turned off, you can turn it back on by pressing any front-panel key.

To set up a waterfall display

- 1 Activate the trace you want to use for a waterfall display.
- 2 Press [**Disp Format**] [**WATERFALL SETUP**] [**WATERFALL STEPS**] <number> [**ENTER**] to specify the number of measurements you want to store in the waterfall buffer.
- 3 Press [**Z-AXIS RANGE**], then enter the range of measurements you want to observe in the waterfall display.
- 4 Press [**WATERFALL ON OFF**] to highlight ON.
- 5 If the analyzer is not currently measuring, press [**Start**].

When you set [**WATERFALL ON OFF**] to ON, the analyzer adds a new trace to the upper portion of a waterfall display each time a measurement (or an averaged set of measurements) is completed. Older traces flow toward the bottom of the display through its lower portion. The value you enter under [**Z-AXIS RANGE**] determines how many traces will be displayed in the lower portion of the waterfall display.

The analyzer uses a waterfall buffer to store the results of the last N measurements (or the last N averaged sets of measurements). You specify the value of N under [**WATERFALL STEPS**]. After you pause a measurement, you can use the waterfall markers—described later in this chapter—to go back and analyze the traces in the waterfall buffer.

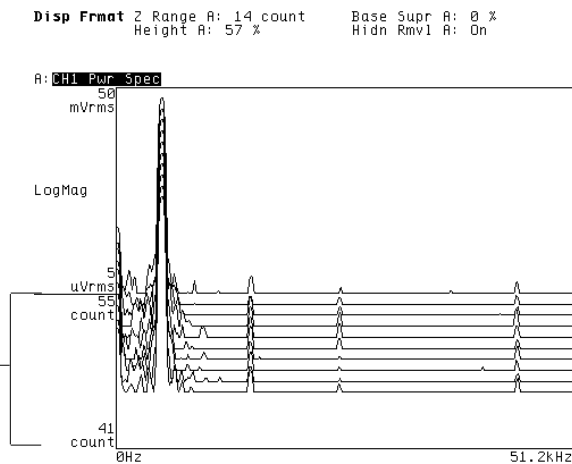

The Z-axis range determines how many traces appear in this part of the waterfall display.

To enhance a waterfall display

- 1 Activate the trace that's being used for a waterfall display.
- 2 Press **[Disp Format]** [WATERFALL SETUP].
- 3 If you want older traces to shift to the left as they flow toward the bottom of the trace area, press **[SKEW ON OFF]** to highlight ON.
- 4 If you want to remove noise floor clutter from traces in the waterfall, press **[BASELINE SUPPRESS]**, then press the up-arrow hardkey until the noise floor is not displayed.
- 5 If you want to use more of the trace area to display the Y-axis, press **[MORE]** [TRACE HEIGHT], then press the up-arrow hardkey one or more times.

The analyzer also allows you to change the angle of a skewed waterfall display. Press **[SKEW ANGLE]**, then enter a value between 0 and 45 degrees. The value you enter is rounded up to the nearest multiple of 5 degrees.

If you turn skewing on or off, change the skew angle, or change the trace height while the analyzer is measuring, the waterfall display is cleared. The analyzer starts filling the cleared display with new traces as measuring continues. When you pause the measurement, cleared traces that are still stored in the waterfall buffer will be redisplayed if the waterfall markers are turned on. See online help for more information about the waterfall parameters.

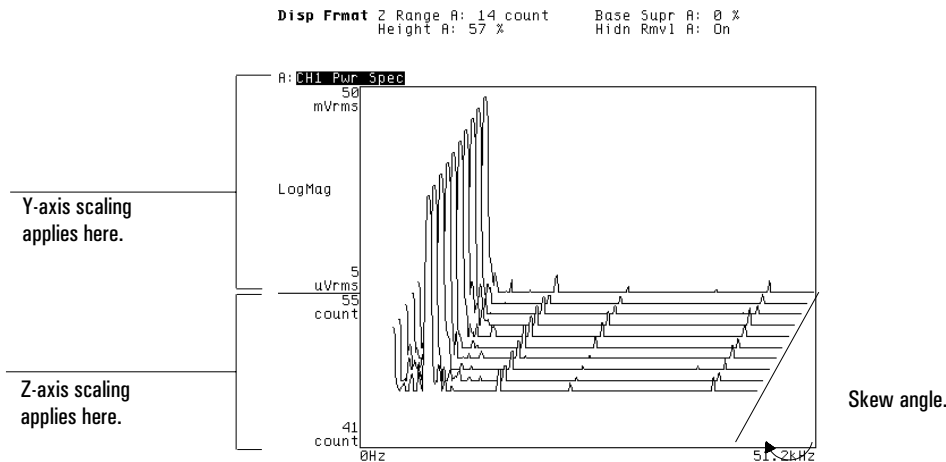

To display the waterfall buffer

- 1 Set up a waterfall display as described earlier in this chapter.
- 2 If the analyzer is measuring, press **[Pause/Cont]** to pause it.
- 3 Press **[Meas Data]**, then press the softkey corresponding to the measurement results you want to examine.
- 4 Press **[Marker Fctn]** **[WATERFALL MARKERS]**.
- 5 If you want to examine older portions of the buffer, press **[SCROLL DOWN]**.

The nature of a waterfall display is somewhat different when the analyzer is measuring than when it is paused. When the analyzer is measuring, the waterfall display provides a visual record of the last N measurements—where N is determined by the setting of **[Z-AXIS RANGE]**. This visual record is cleared each time you rescale the X-, Y-, or Z-axis or change the waterfall skew angle or trace height. In addition, you can only analyze the record by estimating a particular feature's position on the screen.

When the analyzer is paused, the waterfall display can be used to display the contents of the waterfall buffer. The buffer stores the results of the last M measurements—where M is determined by the setting of **[WATERFALL STEPS]**. You can display the buffer in N-sized chunks and analyze its contents more precisely by turning on the waterfall markers.

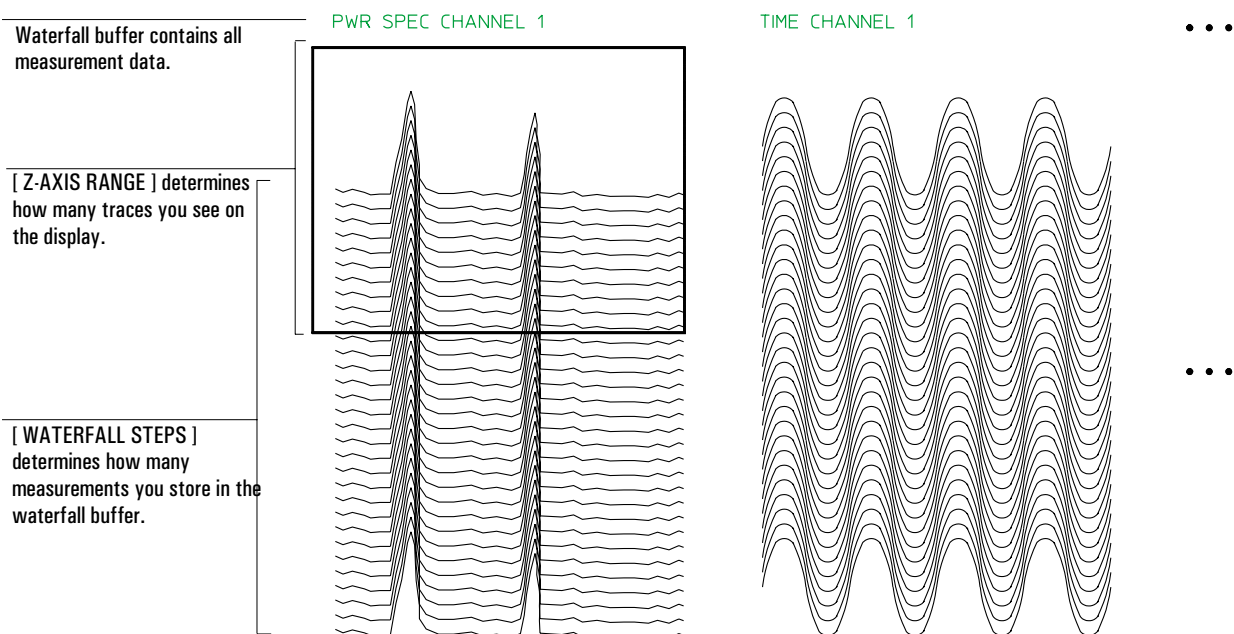

To display one trace from the waterfall buffer

- 1 Complete “To display the waterfall buffer.”
- 2 Press [Marker Fctn] [WATERFALL MARKERS] [TRACE SELECT].
- 3 Turn the knob to select the trace you want to examine, then press [SAVE AND DISP DATA].

When you press [SAVE AND DISP DATA], the analyzer stores the selected waterfall trace in a data register. (The waterfall’s current scaling, coordinate system, and unit selections are also stored with the trace.) You can specify which data register should be used to store the trace by pressing [SELECT SAVE REG] and the corresponding [Dx] softkey.

After the trace is stored, the data register is automatically displayed in the waterfall display’s companion trace area. When one trace area is active, A and B are companions and C and D are companions. When two trace areas are active, A and C are companions and B and D are companions. If you want the companion trace area to be updated automatically when you select another waterfall trace, press [AUTO SAVE ON OFF] to highlight ON.

Trace C displays the selected waterfall trace when Trace D displays the waterfall.

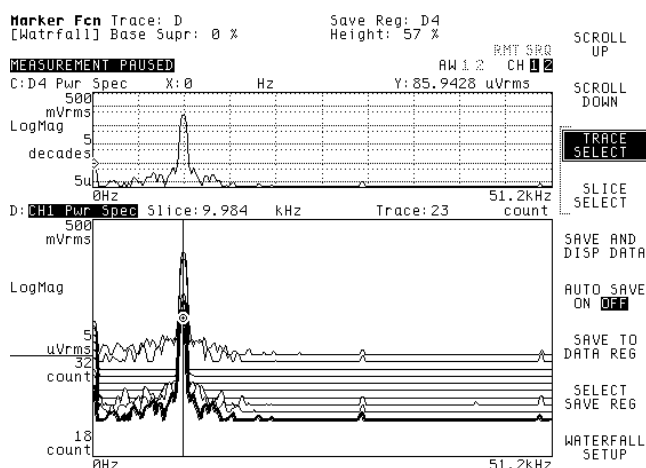

Select [UPPER/BIG LOWER] under [Disp Format] for this trace arrangement.

To display a slice through the waterfall buffer

- 1 Complete "To display the waterfall buffer."
- 2 Press [**Marker Fctn**] [**WATERFALL MARKERS**] [**SLICE SELECT**].
- 3 If you want to see the vertical slice marker, press [**WATERFALL SETUP**], press [**SKEW ON OFF**] to highlight **OFF**, then press [**Rtn**].
- 4 Turn the knob to select the slice you want to examine, then press [**SAVE AND DISP DATA**].

The analyzer creates a slice by sampling the Y-axis value of each trace in the waterfall buffer at the same X-axis position. The number of points in the slice is equal to the number of traces in the buffer. When the slice is displayed, its X-axis unit matches the Z-axis unit of the waterfall. See the previous task if you want to know what happens when you press [**SAVE AND DISP DATA**].

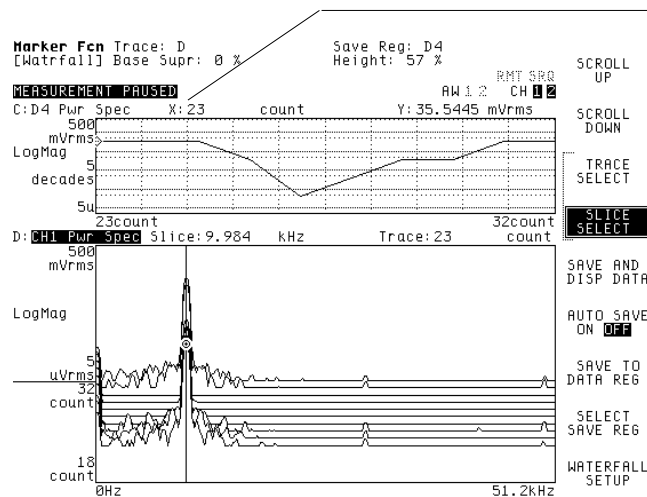

The X-axis readout indicates which waterfall trace provided the displayed Y-axis readout.

10

Scaling the Display

This chapter shows you how to control display scaling.

To enable Y-axis autoscaling

- 1 Activate the trace you want to scale.
- 2 Press [Scale], then press [AUTOSCALE ON OFF] to highlight ON.

When autoscaling is on, the analyzer rescales the Y-axis each time a trace is updated to optimize the display of that trace. Note that autoscaling changes the values of several softkeys: [TOP REFERENCE], [CENTER REFERENCE], [BOTTOM REFERENCE], and [Y PER DIV (DECADES)]. For more information, see “To scale the Y-axis with Reference and Y Per Div softkeys.”

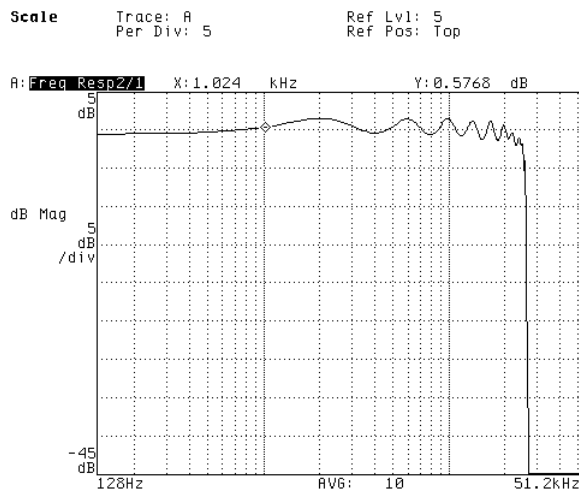

Before autoscaling.

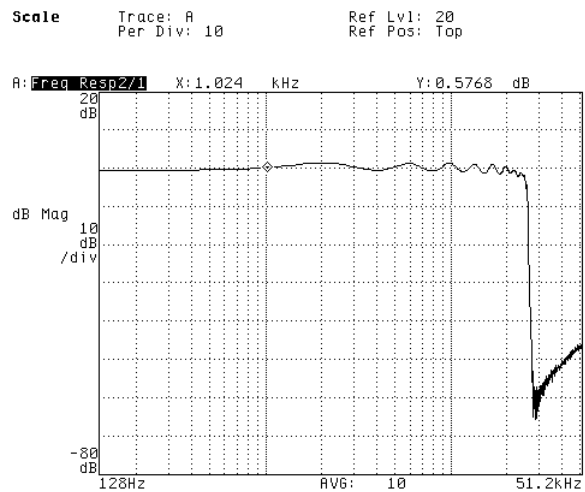

After autoscaling.

To scale the Y-axis with Reference and Y Per Div softkeys

- 1 Activate the trace you want to scale.
- 2 Press [**Scale**].
- 3 If you want to change the top of the display, press [TOP REFERENCE]. If you want to change the center of the display, press [CENTER REFERENCE]. If you want to change the bottom of the display, press [BOTTOM REFERENCE].
- 4 Turn the knob, press an arrow key, or enter a number to change the reference value.
- 5 Press [Y PER DIV (DECADES)], then turn the knob, press an arrow keys, or enter a number to compress or expand the trace along its Y-axis.

When you adjust the value of [Y PER DIV (DECADES)], the currently-active reference (top, center, or bottom) is held constant and the rest of the Y-axis is compressed or expanded around this reference. [Y PER DIV (DECADES)] specifies the number of decades between the top and bottom of the Y-axis when the log magnitude coordinate system is selected; it specifies the distance between graticule lines when any other coordinate system is selected. (The coordinate system is selected under the [Trace Coord] hardkey.)

Hint: The reference softkey with a box around it is the currently-active reference.

With [TOP REFERENCE] selected, this value remains constant as [Y PER DIV] changes.

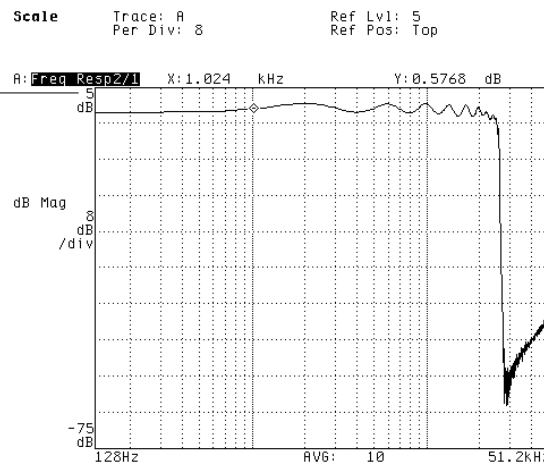

To set top and bottom values for the Y-axis

- 1 Activate the trace you want to scale.
- 2 Press **[Scale]** **[TOP REFERENCE]** <number> **[BOTTOM]** <number> **[ENTER]**.

When you press **[TOP REFERENCE]**, an entry window is displayed at the top of the screen. You can use this window in one of two ways:

- You can enter a new value for the top of the Y-axis (as described in the previous task).
- You can enter new values for both the top and the bottom of the Y-axis (as described in this task).

The first number you type is used as the value for the top of the Y-axis. **[BOTTOM]** inserts a comma, indicating that the second number you type should be used as the value for the bottom of the Y-axis. **[ENTER]** completes the numeric entry, causing the new values to take effect.

To scale the Y-axis with axes scale markers

- 1 Activate the trace you want to scale.
- 2 Press [**Scale**] [AXES SCAL MARKERS], then press [AXIS X Y] to highlight Y.
- 3 Press [HOLD SCALE], then press one of the following to select the marker (or markers) you want to move: [MOVE TOP], [MOVE CENTER], [MOVE BOTTOM], [CHANGE WIDTH], or [WIDTH IN DECADES].
- 4 Turn the knob, press an arrow key, or enter a number to move the selected marker (or markers).
- 5 If you want to expand the area between the markers, press [SCALE AT MARKERS].
- 6 If you want to undo any of these procedures, press [FULL SCALE].

The scale markers are two lines that appear when you press [AXES SCAL MARKERS]. The axes scale markers let you enlarge a portion of the display for closer examination. Remember that enlarging a portion of the display does not increase the analyzer's amplitude or frequency resolution—it simply makes it easier to examine displayed data.

Hint: After scaling to the axes scale markers, you can continue to modify the scaled region using the [MOVE TOP], [MOVE CENTER], [MOVE BOTTOM], and [CHANGE WIDTH] (or [WIDTH IN DECADES]) softkeys.

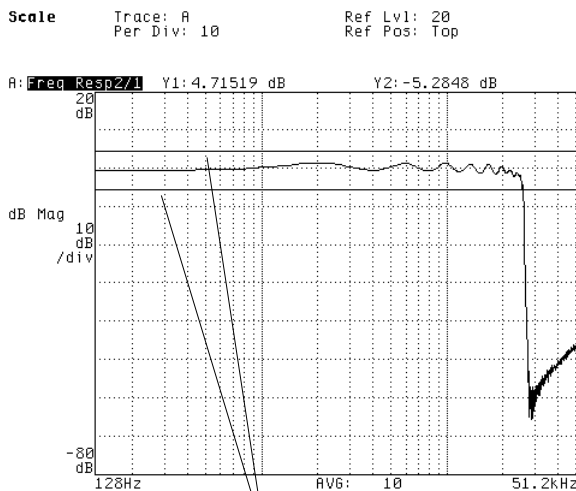

Move the axes scale markers to the part of the display you want to examine.

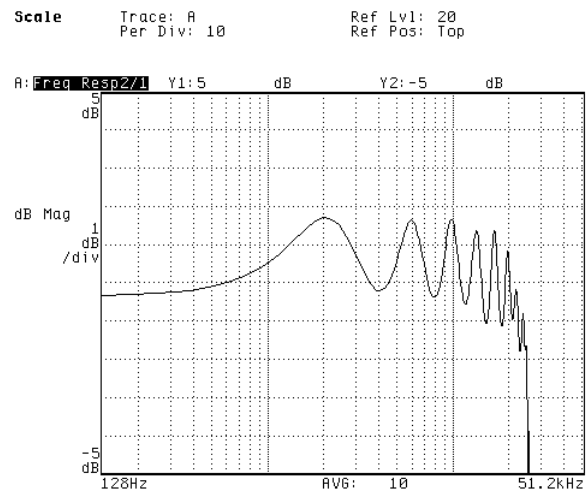

Press [SCALE AT MARKERS] to expand the area between the markers.

To match Y-axis scaling of another trace

- 1 Activate the trace (or traces) you want to scale.
- 2 Press [Scale] [MATCH Y SCALE].
- 3 Press the [TO TRACE *x*] corresponding to the trace whose Y-axis scaling you want to use in the active trace(s).

This is a convenient way to set the same Y-axis scaling for multiple traces. Remember that the analyzer changes the scale only if the coordinate systems are compatible.

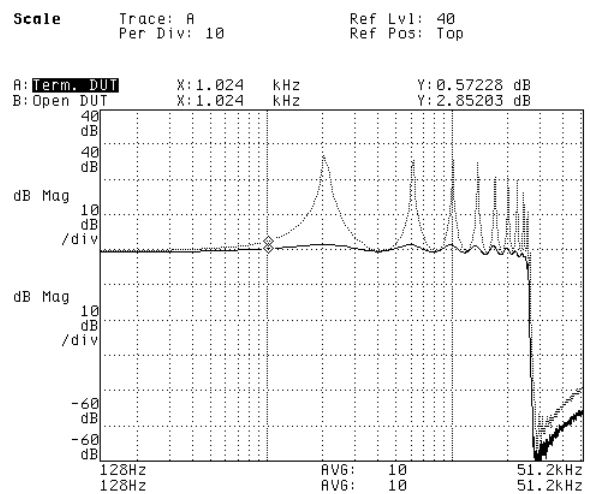

Comparing these two traces is more difficult with a mismatched Y-axis.

Matching the Y-axes makes it easier to compare these two traces.

To scale the X-axis with axes scale markers

- 1 Activate the trace you want to scale.
- 2 Press [**Scale**] [AXES SCAL MARKERS], then press [AXIS X Y] to highlight X.
- 3 Press [HOLD SCALE], then press one of the following to select the marker (or markers) you want to move: [MOVE LEFT], [MOVE CENTER], [MOVE RIGHT], [CHANGE WIDTH], or [WIDTH IN DECADES].
- 4 Turn the knob, press an arrow key, or enter a number to move the selected marker (or markers).
- 5 If you want to expand the area between the markers, press [SCALE AT MARKERS].
- 6 If you want to undo any of these procedures, simply press [FULL SCALE].

The scale markers are two lines that appear when you press [AXES SCAL MARKERS]. The axes scale markers let you enlarge a portion of the display for closer examination. Remember that enlarging a portion of the display does not increase the analyzer's amplitude or frequency resolution—it simply makes it easier to examine displayed data.

Hint: After scaling to the axes scale markers, you can continue to modify the scaled region using the [MOVE LEFT], [MOVE CENTER], [MOVE RIGHT], and [CHANGE WIDTH] (or [WIDTH IN DECADES]) softkeys.

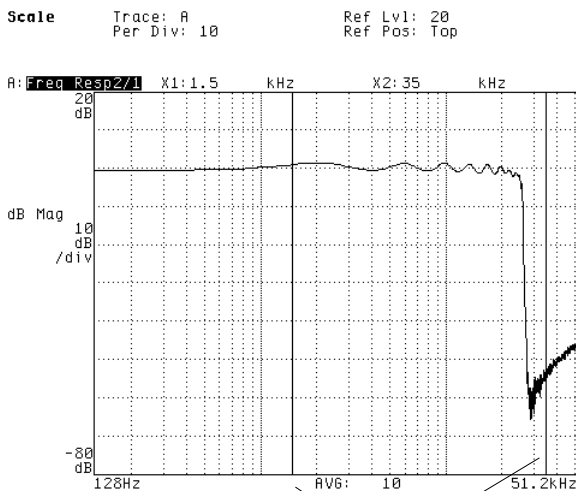

Move the axes scale markers to the part of the display you want to examine.

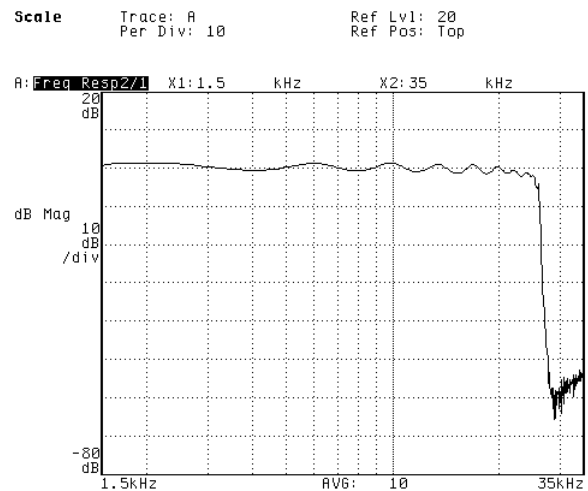

Press [SCALE AT MARKERS] to expand the area between the markers.

To match X-axis scaling of another trace

- 1 Activate the trace (or traces) you want to scale.
- 2 Press [Scale] [MATCH X SCALE].
- 3 Press the [TO TRACE x] corresponding to the trace whose X-axis scaling you want to use in the active trace(s).

This is a convenient way to set the same X-axis scaling for multiple traces. Remember that the analyzer changes the scale only if the coordinate systems are compatible.

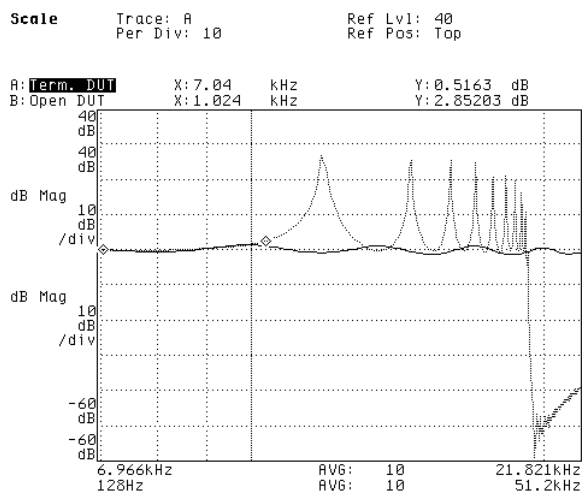

Comparing these two traces is more difficult with a mismatched X-axis.

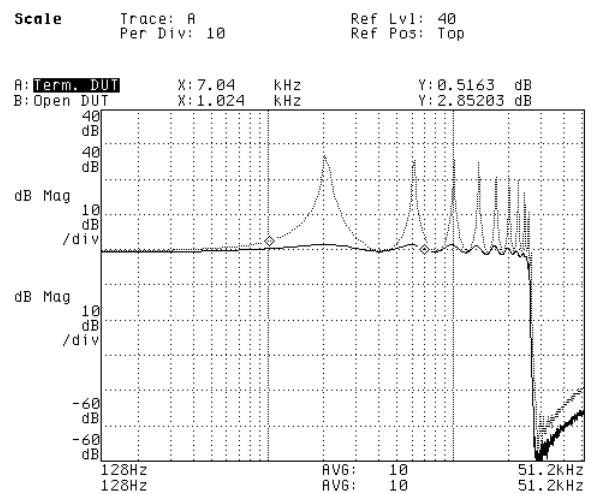

Matching the X-axes makes it easier to compare these two traces.

11

Selecting Display Units

This chapter shows you how to select the units used to quantify displayed values. It also shows you how to select the units your transducers use to quantify energy.

To select a coordinate system

- 1 Activate the trace you want to display in a different coordinate system.
- 2 Press [**Trace Coord**].
- 3 If you want to see magnitude versus frequency (or time), press one of the following: [LINEAR MAGNITUDE], [LOG MAGNITUDE], or [dB MAGNITUDE].
- 4 If you want to see phase versus frequency, press [PHASE] or [UNWRAPPED PHASE].
- 5 If you want to see time versus frequency, press [MORE CHOICES] [GROUP DELAY].
- 6 If you want to see real or imaginary values, press [MORE CHOICES], then press one of the following: [REAL PART], [IMAGINARY PART], [NYQUIST DIAGRAM], or [POLAR DIAGRAM].

The coordinate system determines which unit selections (made in the following tasks) will apply to the X-axis and Y-axis. For example, the phase unit selection only applies when you select a coordinate system that displays phase.

Note: The options you select under the [**Meas Data**] hardkey can limit the availability of coordinate systems.

To select the frequency/time unit

- 1 Activate the trace whose frequency/time unit you want to select.
- 2 Press [**Trace Coord**] [X UNITS].
- 3 Press one of the following: [HZ (SEC)], [CPM (SEC)], or [ORDER (REV)].
- 4 If you pressed [ORDER (REV)], press [ORDER SETUP] [HZ/ORDER RATIO], then enter the frequency corresponding to one order (in Hz or rpm).

If you prefer, you can use the marker to set the value of [HZ/ORDER RATIO]. Just turn the knob to place the marker on the frequency corresponding to one order, then press [ORDER AT MKR].

Note: The options you select under the [**Meas Data**] and [**Trace Coord**] hardkeys can limit the availability of X-axis units.

To select the phase unit

- 1 Activate the trace whose phase unit you want to select.
- 2 Press [**Trace Coord**] [Y UNITS].
- 3 If you want phase values displayed in degrees, press [PHASE DEG RAD] to highlight DEG.
- 4 If you want phase values displayed in radians, press [PHASE DEG RAD] to highlight RAD.

Phase values are displayed only when you select one of the following softkeys (under the [**Trace Coord**] hardkey): [PHASE], [UNWRAPPED PHASE], or [POLAR].

To select the amplitude unit

- 1 Activate the trace whose amplitude unit you want to select.
- 2 Press [**Trace Coord**] [Y UNITS], then press one of the following: [VOLT], [VOLT²], [V/rtHz], [V²/Hz (PSD)], or [V²s/Hz (ESD)].
- 3 Press [AMPLITUDE PK PP RMS] to highlight one of the following: PK to display peak amplitude values, PP to display peak-to-peak values, or RMS to display root-mean-square values.

If you have transducer units turned on, each occurrence of VOLT or V in the Y Units menu is replaced by EU. EU is an abbreviation for engineering units—an alternate name for transducer units. The next task tells you how to turn on transducer units.

Note: The options you select under the [**Meas Data**] and [**Trace Coord**] hardkeys can limit the availability of Y-axis units.

To specify a transducer's unit and sensitivity

- 1 Press [**Input**], then press [CHANNEL 1 2] (or [CHANNEL 1 2 3 4]) to highlight the channel connected to the transducer.
- 2 Press [XDCR UNIT CH_x SETUP] [XDCR UNIT LABEL]. (You can also press [MORE CHOICES] to display additional units.)
- 3 If one of the displayed menus includes your transducer's input unit, press the corresponding softkey.
or
If neither menu includes your transducer's input unit, you can enter the unit yourself (from the [MORE CHOICES] menu): press [USER LABEL] [USER UNIT LABEL] [CLEAR ENTRY], then type a label and press [ENTER].
- 4 Press [**Input**] [XDCR UNIT CH_x SETUP] [XDCR SENSITVTY] <number> <unit>.
- 5 If you want the new unit and sensitivity factored into displayed amplitudes, press [XDCR UNIT ON OFF] to highlight ON.

The Agilent 35670A allows you to measure mechanical devices with a transducer. The transducer must produce an output voltage that's proportional to some input energy over the range of frequencies measured. The unit you specify in this task is the one that's used to quantify the input energy. The sensitivity you enter is the nominal sensitivity (or calibration factor) of the transducer. The unit and sensitivity settings are *not* lost when you preset or turn off the analyzer. Their use is disabled, however, because [XDCR UNIT ON OFF] is set to OFF.

There is an advantage to directly selecting your transducer's input unit instead of entering a user unit label in step 3. If you select one of the acceleration, velocity, or displacement units, you will be able to quickly convert displayed amplitudes from one of these units to another. The next task shows you how.

You can enter transducer sensitivity in V/EU, EU/V, or dB referenced to 1 V/EU. (EU is an abbreviation for engineering units—an alternate name for transducer units.) You can also enter transducer sensitivity using a calibrator and the [CAL VALUE AT MKR] softkey. For more information on using a calibrator, see "To calibrate a transducer" in chapter 1.

To convert a displayed transducer unit

- 1 Activate the trace whose transducer unit you want to convert.
- 2 Press [**Trace Coord**] [Y UNITS] [XDCR UNIT CONVERT].
- 3 Press the softkey corresponding to the unit you want to use for displayed amplitude values.

The following transducer units are used to quantify acceleration, velocity, and displacement:

- g, m/s², inch/s² (acceleration)
- m/s, inch/s (velocity)
- m, inch, mil (displacement)

If you selected one of these units in the previous task, the analyzer allows you to quickly convert displayed amplitude values to any one of the others. This feature is useful when your transducer quantifies energy using one unit but you want to display results using another.

To display amplitude in dBm

- 1 Activate the appropriate trace.
- 2 Press [**Trace Coord**] [dB MAGNITUDE].
- 3 Press [Y UNITS] [dB REF SETUP] [dBm].
- 4 Press [dBm REF IMPEDANCE], then enter the impedance of your test device.

To display dBm, you must have the dB magnitude trace coordinate selected. Also, transducer units must be turned off. See “To select a transducer unit” if you don’t know how to turn off transducer units.

Using Online Help

This chapter shows you how to use the analyzer's online help system, which provides fast access to the operating information you need. Each task describes one of the three ways you can access information in the system:

- pressing a hardkey or softkey
- selecting a hypertext "link" to a related topic
- selecting a topic from the help index

To display help for a key

- 1 Press [**Help**] to enter the online help system.
- 2 Press any hardkey or softkey.
- 3 If the topic is too long to fit on one screen, turn the knob to scroll through it.
- 4 Repeat steps 2 and 3 for each key you want help on.

The first time you use the online help system, press [**5**] (on the numeric keypad) and take a few moments to read the help overview. It's only four pages long, and it includes descriptions of advanced help features—like the index and cross-reference “links”—that can help you locate the information you need more quickly.

Topic title shows you which topic is displayed.

```

Topic: Help hardkey

How to use online Help

If you want to:          you must:
-----
turn help on.....press [Help]
turn help off.....press [Help] or [0]
get help on a key.....press that key
display the index.....press [1]

scroll through a topic.....turn the knob
page through a topic.....press an arrow key
print a topic.....press [8]

select a link *.....turn the knob
display the linked topic....press [4]
return to a previous topic..press [7]

* A "link" is underlined text in the current topic that
is used to display a related topic. The selected link
is highlighted.

Note Turn the knob to display more of this
topic.

Prev Topic-7      Print-8      Prev Page-↑      Index-1
Jmp To Topic-4   Help On Help-5  Next Page-↓      Quit-0
  
```

Scroll bar shows you how much of the topic is displayed.

Legend shows you which help functions are assigned to the numeric keypad.

To display a related help topic

- 1 Turn the knob to select a “link” in the current help topic.
- 2 Press [4] to display the related topic.
- 3 Press [7] to return to the original topic.

On a given screen full of help text, there may be several special words (or phrases) that are linked to related topics. One of these words is highlighted to identify it as the currently-selected link; the others are underlined. The knob allows you to select a different link by moving the highlighting from one link to the next. Once you've selected the link you want, press [4] to display the related topic.

You can follow links through as many as 20 topics and still return to the original topic. Just press [7] one time for each link you followed, and you'll return to the original via all of the related topics you displayed.

```
Topic: Instrument Mode softkeys
Key Path: [Inst Mode]

Press one of the Instrument Mode softkeys to select a
major measurement mode for the analyzer.

When you press an Instrument Mode softkey, the
analyzer's menu structure changes to match the
requirements of a particular set of measurements. The
values and limits of some measurement and display
parameters also change.

Note The current parameter values for a given
mode are saved when you exit that mode, and
restored when you return to it.

The instrument mode softkeys are:

* [FFT ANALYSIS]
* [OCTAVE ANALYSIS] (with option 1D1)
* [ORDER ANALYSIS] (with option 1D0)
* [SWEEP SINE] (with option 1D2)
* [CORRELATION ANALYSIS]
* [HISTOGRAM/TIME]
```

[7] returns you to the previous topic.

[4] displays the related topic.

The selected link is identified by highlighting.

Other links are identified by underlining.

Prev Topic-7 Print-8 Prev Page-↑ Index-1
Jmp To Topic-4 Help On Help-5 Next Page-↓ Quit-0

To select a topic from the help index

- 1 Press **[Help]** to enter the online help system.
- 2 Press **[1]** on the numeric keypad to display the index.
- 3 If you want to move through the index one page at a time, press the down-arrow or up-arrow hardkey.
- 4 Turn the knob to select the topic you want help on.
- 5 Press **[4]** to display the topic.

The help index contains an alphabetical listing of all help topics. Most topics listed in the index describe the hardkeys and softkeys, but some are of a more general nature. These more general topics are only available via the index or “links” from related topics.

Some index entries provide cross-references to the available help topics. These entries end with “(XREF).” The name of an XREF entry does not match the name of the topic it displays.

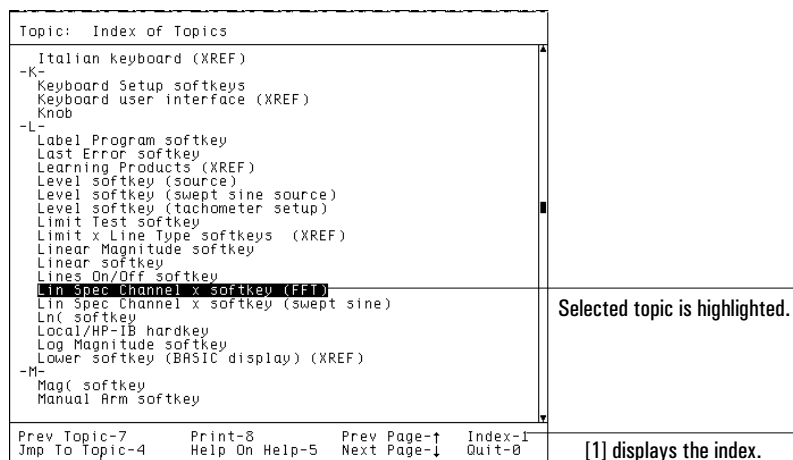

To print a help topic

- 1 If online help is displayed, press [0] (on the numeric keypad) to exit the help system.
- 2 Set up your printer—as described in chapter 14—if you haven't already.
- 3 If you are using a GPIB printer, press [**Local/GPIB**] [SYSTEM CONTROLLR].
- 4 Enter the online help system and display the topic you want to print.
- 5 Press [8] (on the numeric keypad).

When you press [8], the analyzer prints all of the topic's text—not just the text that is currently displayed on the analyzer's screen. Graphics, however, are not printed. If you prefer to create a print file, see “To plot screen contents” in chapter 14. It describes two additional steps that you can use to direct plotting or printing to a file. You should insert them after step 2 of this task.

To exit the help system

- Press [**Help**].
or
Press [**0**] (on the numeric keypad).

When you exit the help system, the analyzer restores the menu that was displayed before you entered the system.

Managing Files and Disks

This chapter shows you how to save your work on the analyzer's file system. It also shows you how to perform some additional disk operations.

To set up an external disk

- 1 Turn off your external disk drive and analyzer, then connect their GPIB ports with an GPIB cable.
- 2 Turn on the disk drive and analyzer.
- 3 Determine the disk drive's GPIB address.
- 4 On the analyzer, press [**Local/GPIB**] [DISK ADDRESS] <number> [ENTER].

You can use one of the Agilent 10833 GPIB cables to connect the analyzer to your external disk drive. These cables range in length from 0.5 to 4 meters. They are available through your local Agilent Technologies, Inc. Sales and Service Office.

Refer to your external disk's documentation if you don't know how to turn it on or determine its GPIB address. When you determine the address, write it down; this is the value you will substitute for <number> in step 4.

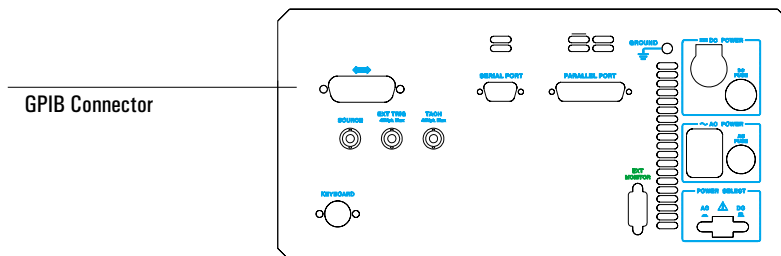

To select the default disk

- 1 Press [**Disk Utility**] [DEFAULT DISK].
or
Press [**Save/Recall**] [DEFAULT DISK].
- 2 Press one of the following: [NON-VOL RAM DISK], [VOLATILE RAM DISK], [INTERNAL DISK], or [EXTERNAL DISK].
- 3 If you selected [EXTERNAL DISK] in step 2, press [EXTERNAL DISK UNIT] <number> [ENTER], then press [**Local/GPIB**] [SYSTEM CONTROLLER].

Your default disk selection tells the analyzer which disk to use when it is saving and recalling files. You can use online help to learn more about these options, but here's a quick summary:

- [NON-VOL RAM DISK] selects a portion of the analyzer's battery-backed RAM. This "disk" stores about 100 Kbytes of data without option UFF. It stores about 1.1 Mbytes if you add option UFF. In either case, the data is not lost when you turn off the analyzer.
- [VOLATILE RAM DISK] selects a portion of RAM that is *not* battery-backed. Data on this "disk" is lost when you turn off the analyzer. However, the disk has two advantages: you can format it to hold more data than the nonvolatile RAM disk, and file operations are much faster than on the internal disk.
- [INTERNAL DISK] selects the analyzer's internal disk drive. This drive stores data on 3.5-inch flexible disks (double-sided, double- or high-density). For more information, see the following task, "To format a flexible disk".
- [EXTERNAL DISK] selects a disk drive connected to the analyzer via its GPIB connector. The disk must be connected as described in the previous task, "To set up an external disk." If the disk has only one mass storage unit, enter a value of 0 for [EXTERNAL DISK UNIT]. If it has more than one mass storage unit, enter the number of the unit you want to use.

To format a flexible disk

- 1 Select the analyzer's internal disk drive as the default disk (as described in the previous task).
- 2 Insert a double-sided, 3.5-inch flexible disk into the internal disk drive.
- 3 Press **[Disk Utility]** **[FORMAT DISK]** **[INTRLEAVE FACTOR]** **0** **[ENTER]**.
- 4 If you want the disk formatted for MS-DOS^{*}, press **[DISK TYPE LIF DOS]** to highlight DOS.
or
If you want the disk formatted for LIF, press **[DISK TYPE LIF DOS]** to highlight LIF.
- 5 Press **[PERFORM FORMAT]** **[ENTER]**.

CAUTION

You can damage both the disk and the drive if you attempt to eject a disk when the "FORMAT DISK In Progress" message is displayed or when the disk's "busy" light is on.

You must format a 3.5-inch flexible disk before you can use it to store Agilent 35670A data. Use a double-sided disk—either double-density or high-density—that is *not* write-protected. The analyzer takes about two and a half minutes to format a disk and is unavailable for other tasks during that time. For information on the formatting parameters, use online help.

Do not eject the disk when the "busy" light is on.

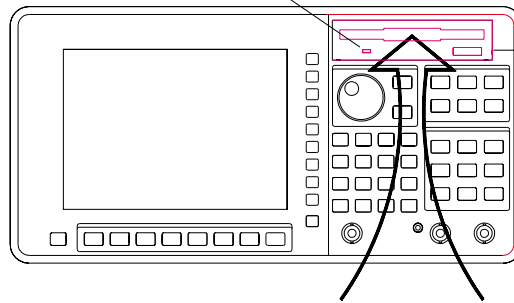

The disk-eject button.

Use a 3.5-inch flexible disk (DS DD or DS HD).

* MS-DOS is a U.S. registered trademark of Microsoft Corporation.

To change the current DOS directory

- 1 Press [**Disk Utility**] [DEFAULT DISK] [DEFAULT DIRECTORY].
or
Press [**Save/Recall**] [DEFAULT DISK] [DEFAULT DIRECTORY].
- 2 If you want a subdirectory of the current directory to be the new current directory, press [CLEAR ENTRY], type the subdirectory's name, and press [ENTER].
- 3 If you want any other directory to be the new current directory, press [CLEAR ENTRY], type the path to that directory followed by its name, and press [ENTER].

DOS-formatted disks can contain a hierarchical directory structure, such as the one shown at the bottom of the page. Your current directory selection tells the analyzer which directory to use when it is saving and recalling files.

A "path" includes the names of all directories encountered on the way to a particular directory or file. If your path starts from the current directory, the first element of the path is the name of the first subdirectory encountered. If it starts from the main (or "root") directory, the first element in the path is "\", which represents the root directory. The "\" character is also used to separate directory names in the path.

In the example directory shown below, you could change the current directory from "STATES" to "FFT" by entering either of the following strings:

- FFT
- \STATES\FFT

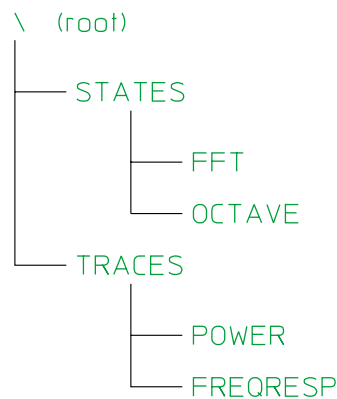

Example directory structure.

To create a DOS directory

- 1 Press **[Disk Utility]** [DEFAULT DISK] **[CREATE DIRECTORY]**.
or
Press **[Save/Recall]** [DEFAULT DISK] **[CREATE DIRECTORY]**.
- 2 If you want to create a subdirectory in the current directory, type the new subdirectory's name and press **[ENTER]**.
- 3 If you want to create a subdirectory in some other directory, type the path to that other directory followed by the new subdirectory's name and press **[ENTER]**.

You can create new directories only on DOS-formatted disks. You cannot create them on LIF-formatted disks, because the LIF format does not support a hierarchical directory structure.

See the previous task for more information on paths.

To save a trace

- 1 Press [**Active Trace**], then press the softkey corresponding to the trace you want to save: [A], [B], [C], or [D].
- 2 Press [**Save/Recall**] [SAVE DATA] [SAVE TRACE].
- 3 If you want to save your trace to the current directory of the default disk, press [INTO FILE], type a file name, and press [ENTER].
- 4 If you want to save your trace to one of the analyzer's internal data registers, press the corresponding [INTO D_x] softkey.

The analyzer also allows you to save all the traces in a waterfall at once—either to disk or to one of the analyzer's internal waterfall registers. In step 2, press [SAVE WATERFALL] instead of [SAVE TRACE]. In step 4, press [INTO W_x] instead of [INTO D_x].

CAUTION

The contents of data registers and waterfall registers are lost at power-down. Be sure to save important traces to disk before you turn off the analyzer.

Although you can save a trace to any data register, it is best not to save to D6-D8 if you use the optional curve fit and synthesis features. These registers are used during curve fitting and synthesis operations.

The analyzer allow you to save data in two formats, SDF and ASCII. Use the SDF format if you want to recall the data into the analyzer. Use the ASCII format if you want to tranfer the data to an application that can read ASCII data, such as a PC program. ASCII data cannot be recalled into the analyzer.

To save a program

- 1 Press **[BASIC]** **[INSTRUMNT BASIC]** **[SELECT PROGRAM]**, then press the softkey corresponding to the program you want to save.
- 2 If you want to save the program in an ASCII-encoded file, press **[Save/Recall]** **[SAVE MORE]**, then press **[SAVE PROG ASCII BIN]** to highlight ASCII.
- 3 If you want to save the program in a binary-encoded file, press **[Save/Recall]** **[SAVE MORE]**, then press **[SAVE PROG ASCII BIN]** to highlight BIN.
- 4 Press **[SAVE PROGRAM]**, type a file name, and press **[ENTER]**.

If you are saving the selected Instrument BASIC program for the first time, it will be saved in the current directory of the default disk as soon as you press **[ENTER]**. If you are resaving the program, as you might after editing, you must press **[OVERWRITE FILE]** after you press **[ENTER]**.

If you are editing a program, you must press **[END EDIT]** before you can save the program as described in this task. However, you can skip step 1, because the program you are editing is already selected as the active program.

Select ASCII-encoding to minimize the size of the program file. Select binary-encoding to minimize the amount of time it takes to save and recall the file.

To save other data

- 1 Press [**Save/Recall**].
- 2 If you want to save the contents of the time-capture buffer, press [SAVE DATA] [SAVE CAPTURE].
- 3 If you want to save the current instrument state, press [SAVE STATE].
- 4 If you want to save a limit, a set of math definitions, a data table, a curve-fit table, or a synthesis table, press [SAVE MORE], then press the corresponding SAVE softkey.
- 5 Type a file name, then press [ENTER].

After you press [ENTER], the analyzer saves the specified data in the current directory of the default disk. If you are saving a limit or a data table, it is saved from a single trace: the most active trace. (For a definition of the most active trace, see online help for the [**Active Trace**] hardkey.)

The analyzer also allows you to save the instrument state in a special file called "AUTO_ST." This file is created on the nonvolatile RAM disk when you press [**Save/Recall**] [SAVE MORE] [SAVE AUTOSTATE]. When you turn on the analyzer, it loads this file automatically—replacing the analyzer's preset state. For more information on this feature, see online help for [SAVE AUTOSTATE].

To recall a trace

- 1 Press [Save/Recall], then press [CATALOG ON OFF] to highlight ON.
- 2 Turn the knob to highlight the trace file you want to recall.
- 3 If you want to recall a trace with its original scaling, press [RECALL DATA] [RCL TRACE AND SCALE].
- 4 If you want to recall a trace but retain the scaling of the data register you will use, press [RECALL DATA] [RCL TRACE].
- 5 Press the [FROM FILE INTO D_x] softkey corresponding to the data register you want to use, then press [ENTER].
- 6 Press [Active Trace], then press the softkey corresponding to the trace you want to replace: [A], [B], [C], or [D].
- 7 Press [MEAS DATA] [MORE CHOICES] [DATA REGISTER], then press the [D_x] softkey corresponding to the data register you specified in step 5.

A trace that is recalled from a file is always recalled into a data register. Steps 4 and 5 allow you to view the recalled trace by selecting the contents of that register for display. If a trace was saved to a data register instead of a file, you only need to complete steps 6 and 7 to “recall” that trace.

Although you can recall a trace file into any data register, it is best not to recall into D6-D8 if you use the optional curve fit and synthesis features. These registers are used during curve fitting and synthesis operations.

The analyzer recalls the highlighted trace file into the specified data register.

Save/Rec Def Disk: Internal

MEASUREMENT PAUSED					RMT SRG	FROM FILE
					AW 1.2	INTO D1
					CH 1	
DIRECTORY: \						
DOS	INT:	SIZE	TYPE	AVAILABLE SPACE:	1457664	
FILE NAME				LAST CHANGED		
DOWNLOAD		1449	DOS	09-22-92	03:03:06	PM FROM FILE
FILTER1.DAT		3362	DOS	09-22-92	03:31:12	PM INTO D2
FILTER2.DAT		3362	DOS	09-22-92	03:31:24	PM FROM FILE
FILTER3.DAT		3362	DOS	09-22-92	03:32:02	PM INTO D3
CAL TRN.DAT		3362	DOS	09-22-92	03:33:10	PM FROM FILE
SETUP4.STA		5768	DOS	09-22-92	03:43:01	PM INTO D4
SETUP2.STA		5768	DOS	09-22-92	03:44:11	PM FROM FILE
ARBSOURC		8151	DOS	09-22-92	03:50:02	PM INTO D5
SHELLBEG		857	DOS	09-22-92	03:52:11	PM FROM FILE
SHELLCHN		425	DOS	09-22-92	03:53:13	PM INTO D5
SHELLDEM		382	DOS	09-22-92	03:54:05	PM FROM FILE
SHELLEND		784	DOS	09-22-92	03:54:17	PM INTO D6
LIMITS		0	DIR	09-22-92	04:31:27	PM FROM FILE
ULIM1.LIM		25410	DOS	09-22-92	04:22:04	PM INTO D7
LLIM1.LIM		25410	DOS	09-22-92	04:22:26	PM FROM FILE
					INTO D8	
					CATALOG	
					ON OFF	

To recall a program

- 1 Press [**BASIC**] [INSTRUMNT BASIC] [SELECT PROGRAM], then press the softkey corresponding to the program buffer you want to use.
- 2 Press [**Save/Recall**], then press [CATALOG ON OFF] to highlight ON.
- 3 Turn the knob to highlight the program file you want to recall.
- 4 Press [RECALL MORE] [RECALL PROGRAM] [ENTER].

You can load a recalled Instrument BASIC program into any one of the analyzer's five, independent program buffers. But before you can load a program buffer, it must be selected as the active buffer. Step 1 selects the active buffer.

Save/Rec Def Disk: Internal

MEASUREMENT PAUSED

FILE NAME	SIZE	TYPE	AVAILABLE SPACE:	LAST CHANGED
DOWNLOAD	1449	DOS	1426944	09-22-92 03:03:06 PM
FILTER1.DAT	3362	DOS		09-22-92 03:31:12 PM
FILTER2.DAT	3362	DOS		09-22-92 03:31:24 PM
FILTER3.DAT	3362	DOS		09-22-92 03:32:02 PM
CAL_TRAN.DAT	3362	DOS		09-22-92 03:33:10 PM
SETUP4.STA	5768	DOS		09-22-92 03:43:01 PM
SETUP2.STA	5768	DOS		09-22-92 03:44:11 PM
ARBSOURC	8151	DOS		09-22-92 03:50:02 PM
SHELLBEG	857	DOS		09-22-92 03:52:11 PM
SHELLCHN	425	DOS		09-22-92 03:53:13 PM
SHELLEDM	382	DOS		09-22-92 03:54:05 PM
SHELLEND	784	DOS		09-22-92 03:54:17 PM
LIMITS	0	DIR		09-22-92 04:31:27 PM
ULIMI.LIM	25410	DOS		09-22-92 04:22:04 PM
LLIMI.LIM	25410	DOS		09-22-92 04:22:26 PM
RCLTRACE	30419	DOS		09-24-92 01:35:20 PM

AW 1.2 CH 1.2

RECALL UPPER LIM
RECALL LOWER LIM
RECALL MATH
RECALL DATA TABL
RECALL PROGRAM
RCL FIT TABLE
RCL SYNTH TABLE
RECALL POWERDOWN

To recall other data

- 1 Press [Save/Recall], then press [CATALOG ON OFF] to highlight ON.
- 2 Turn the knob to highlight the file you want to recall.
- 3 If you want to recall data into the time-capture buffer, press [RECALL DATA] [RECALL CAPTURE].
- 4 If you want to recall an instrument state, press [RECALL STATE].
- 5 If you want to recall a limit, a set of math definitions, a data table, a curve-fit table, or a synthesis table, press [RECALL MORE], then press the corresponding RECALL softkey.
- 6 Press [ENTER].

The highlighted file is only recalled if it contains data that matches the RECALL softkey you press. If you are recalling a limit or a data table, it is recalled into all active traces.

It is generally easier to recall a file if you display the disk catalog and highlight the file first. When you do this, the entry window that's displayed when you press a RECALL softkey already contains the correct file name. You only need to press [ENTER] to recall the file. If you don't display the catalog first, you will need to type the file name into the entry window before pressing [ENTER].

Save/Rec Def Disk: Internal

MEASUREMENT: PRUSED					RMT SRQ	RECALL UPPER LIM
DIRECTORY: \					AW 1 2	CH 1 2
DOS	INT:	SIZE	TYPE	AVAILABLE SPACE:	1457664	RECALL LOWER LIM
FILE NAME				LAST CHANGED		
DOWNLOAD		1449	DOS	09-22-92	03:03:06 PM	RECALL
FILTER1.DAT		3362	DOS	09-22-92	03:31:12 PM	MATH
FILTER2.DAT		3362	DOS	09-22-92	03:31:24 PM	
FILTER3.DAT		3362	DOS	09-22-92	03:32:02 PM	
CAL_TRAN.DAT		3362	DOS	09-22-92	03:33:18 PM	RECALL DATA TABL
SETUP4.STA		5768	DOS	09-22-92	03:43:01 PM	
SETUP2.STA		5768	DOS	09-22-92	03:44:11 PM	
ARBSOURC		8151	DOS	09-22-92	03:50:02 PM	
SHELLBEG		857	DOS	09-22-92	03:52:11 PM	RECALL PROGRAM
SHELLCHN		425	DOS	09-22-92	03:53:13 PM	
SHELLDEM		382	DOS	09-22-92	03:54:05 PM	
SHELLEND		784	DOS	09-22-92	03:54:17 PM	
LIMITS		0	DIR	09-22-92	04:31:27 PM	
ULIMI.LIM		25410	DOS	09-22-92	04:22:04 PM	RCL FIT TABLE
LLIMI.LIM		25410	DOS	09-22-92	04:22:26 PM	RCL SYNTH TABLE
						RECALL POWERDOWN

The highlighted file is recalled only if it contains data that matches the RECALL softkey you pressed.

To delete a file

- 1 Press [**Disk Utility**], then press [CATALOG ON OFF] to highlight ON.
- 2 Turn the knob to highlight the file you want to delete.
- 3 Press [DELETE FILE] [ENTER].

When you press [ENTER], the highlighted file is deleted from the current directory of the default disk. If you want to delete all the files from this directory at once, press [DELETE ALL FILES] [ENTER] in step 3.

Disk Util Def Disk: Internal

MEASUREMENT PAUSED RMT SRQ
AW 1.2 CH 1.2

FILE NAME	INT:	SIZE	TYPE	AVAILABLE SPACE:	LAST CHANGED
DOWNLOAD		1449	DOS	1457664	09-22-92 03:03:06 PM
FILTER1.DAT		3362	DOS		09-22-92 03:31:12 PM
FILTER2.DAT		3362	DOS		09-22-92 03:31:24 PM
FILTER3.DAT		3362	DOS		09-22-92 03:32:02 PM
CAL_TRAN.DAT		3362	DOS		09-22-92 03:33:10 PM
SETUP4.STA		5768	DOS		09-22-92 03:43:01 PM
SETUP2.STA		5768	DOS		09-22-92 03:44:11 PM
ARBSOURC		8151	DOS		09-22-92 03:50:02 PM
SHELLBEG		857	DOS		09-22-92 03:52:11 PM
SHELLCHN		425	DOS		09-22-92 03:53:13 PM
SHELLEM		382	DOS		09-22-92 03:54:05 PM
SHELLEND		784	DOS		09-22-92 03:54:17 PM
LIMITS		0	DIR		09-22-92 04:31:27 PM
ULIM1.LIM		25410	DOS		09-22-92 04:22:04 PM
LLIM1.LIM		25410	DOS		09-22-92 04:22:26 PM

INT: indicates that the internal disk is the current default disk.

RENAME FILE

DELETE FILE

DELETE ALL FILES

COPY FILE

COPY ALL FILES

FORMAT DISK

CATALOG **ON** OFF

DEFAULT DISK

The highlighted file is deleted when you press [DELETE FILE].

All files in the displayed directory are deleted when you press [DELETE ALL FILES].

To delete a DOS directory

- 1 Delete all files from the directory you want to delete (as described in the previous task).
- 2 Change the current directory (as described earlier in this chapter) to any other directory.
- 3 Press [**Disk Utility**] [DEFAULT DISK] [DELETE DIRECTORY].
- 4 Press [CLEAR ENTRY], type the path to the directory you want to delete followed by the directory's name, and press [ENTER].

If you want to delete a directory that contains subdirectories, you must first delete the subdirectories (as described in this task). For a definition of a path, see “To change the current DOS directory,” earlier in this chapter.

To copy a file

- 1 Press [**Disk Utility**], then press [CATALOG ON OFF] to highlight ON.
- 2 Turn the knob to highlight the file you want to copy.
- 3 Press [COPY FILE] [SOURCE FILENAME] [ENTER].
- 4 Press [DESTINATN FILENAME], type a disk specifier (optional), a path (also optional), and a file name for the new copy, then press [ENTER].
- 5 Press [PERFORM FILE COPY].

If you do not include a disk specifier or a path in step 4, the file is copied to the current directory of the default disk. (See “To change the current DOS directory” for more information on paths.) The analyzer’s file system recognizes four disk specifiers—one for each of its disks:

- **NVRAM**: specifies the nonvolatile RAM disk.
- **RAM**: specifies the volatile RAM disk.
- **INT**: specifies the internal, 3.5 inch disk drive.
- **EXT**: specifies an external, GPIB disk drive.

These disk specifiers allow you to copy a file from the default disk to one of the other three disks. For example, suppose you wanted to copy the file **meas1.dat** from the internal disk drive (currently selected as the default disk) to the nonvolatile RAM disk. After pressing [DESTINATN FILENAME] in step 3, you would turn the knob to place the cursor at the beginning of **meas1.dat**, and then type **NVRAM:.** When you pressed [ENTER] and [PERFORM FILE COPY], a new copy of **meas1.dat** would be created on the nonvolatile RAM disk.

Disk Util Src Name: FILTER3.DAT
Dest Name: NVRAM:FILTER3.DAT

MEASUREMENT PAUSED

DIRECTORY: \	INT:	SIZE	TYPE	AVAILABLE SPACE:	LAST CHANGED
DOWNLOAD		1449	DOS	09-22-92	03:03:06 PM
FILTER1.DAT		3362	DOS	09-22-92	03:31:12 PM
FILTER2.DAT		3362	DOS	09-22-92	03:31:24 PM
FILTER3.DAT		3362	DOS	09-22-92	03:32:02 PM
CAL_TRAN.DAT		3362	DOS	09-22-92	03:33:10 PM
SETUP4.STA		5768	DOS	09-22-92	03:43:01 PM
SETUP2.STA		5768	DOS	09-22-92	03:44:11 PM
ARBSOURC		8151	DOS	09-22-92	03:50:02 PM
SHELLBEG		857	DOS	09-22-92	03:52:11 PM
SHELLCHN		425	DOS	09-22-92	03:53:13 PM
SHELLEDM		382	DOS	09-22-92	03:54:05 PM
SHELLEND		784	DOS	09-22-92	03:54:17 PM
LIMITS		0	DIR	09-22-92	04:31:27 PM
ULIM1.LIM		25410	DOS	09-22-92	04:22:04 PM
LLIM1.LIM		25410	DOS	09-22-92	04:22:26 PM

AW 1.2 RMT SRG CH 1.2

SOURCE FILENAME

DESTINATN FILENAME

PERFORM FILE COPY

CATALOG ON OFF

INT: indicates that the internal disk is the current default disk.

The highlighted file is displayed automatically in the [SOURCE FILENAME] and [DESTINATN FILENAME] entry windows.

To rename a file

- 1 Press [**Disk Utility**], then press [CATALOG ON OFF] to highlight ON.
- 2 Turn the knob to highlight the file you want to rename.
- 3 Press [RENAME FILE] [ORIGINAL FILENAME] [ENTER].
- 4 Press [NEW FILENAME], type a new name for the file, then press [ENTER].
- 5 Press [PERFORM RENAME].

Plotting and Printing

This chapter shows you how to set up your plotter or printer. It also shows you how to plot and print screen contents.

To set up your hardcopy device—parallel

- 1 Turn off your hardcopy device and analyzer, then connect their parallel ports with a Centronics parallel cable.
- 2 Turn on the device and analyzer.
- 3 Make sure the device is configured for parallel operation.
- 4 Press **[Plot/Print]** [PLOT/PRNT DESTINATN] [OUTPUT TO PARALLEL] to configure the analyzer for parallel operation.
- 5 Press **[Rtn]** [PLOT/PRNT DEVICE], then press the softkey corresponding to the type of device you have connected to the analyzer: [HP-GL PLOTTER], [RASTER PRINTER], or [HP-GL PRINTER].

You can use the Agilent 92284A parallel cable to connect the analyzer to most Hewlett-Packard plotters and printers. This cable and many others are available through your local Agilent Technologies, Inc. Sales and Service Office. The cable you order should not be more than 3 meters long.

Refer to your hardcopy device's documentation if you don't know how to configure it for parallel operation. Refer to online help for more information about the parameters you are setting. If you want to know which signal is connected to each pin of the parallel port, see online help for the [PLOT/PRNT DESTINATN] softkey.

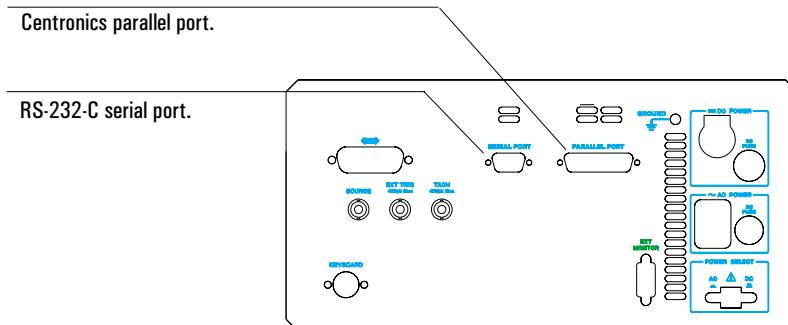

To set up your hardcopy device—serial

- 1 Turn off your hardcopy device and analyzer, then connect their serial ports with an RS-232-C cable.
- 2 Turn on the device and analyzer.
- 3 Make sure the device is configured for serial operation.
- 4 Press [**Plot/Print**] [MORE SETUP] [SERIAL SETUP], then press each softkey in the resulting menu until its value matches the requirements of your hardcopy device.
- 5 Press [**Plot/Print**] [PLOT/PRNT DESTINATN] [OUTPUT TO SERIAL] to configure the analyzer for serial operation.
- 6 Press [**Rtn**] [PLOT/PRNT DEVICE], then press the softkey corresponding to the type of device you have connected to the analyzer: [HP-GL PLOTTER], [RASTER PRINTER], or [HP-GL PRINTER].

You can use the Agilent 24542G serial cable to connect the analyzer to most Hewlett-Packard plotters and printers. This cable and many others are available through your local Agilent Technologies, Inc. Sales and Service Office. (Online help for [PLOT/PRNT DESTINATN] may help you select a cable: It shows you which signal is connected to each pin of the serial port.) The cable you order should not be more than 15 meters long.

You can refer to your hardcopy device's documentation to determine which values you should select for the softkeys in the [SERIAL SETUP] menu. If that documentation is not available, the following information should help you complete step 4:

- Select the highest baud rate that provides reliable plotting or printing.
- Most hardcopy devices use seven or eight character bits and one stop bit.
- Devices that use eight character bits usually require [PARITY] to be set to NONE.
- Most hardcopy devices work with [XMIT PACE] set to XON/XOFF.
- You can ignore the settings of [PRTY CHK] and [RCVR PACE]: they are not used for plotting or printing.

See the previous task for the location of the serial port.

To set up your hardcopy device—GPIB

- 1 Turn off your hardcopy device and analyzer, then connect their GPIB ports with an GPIB cable.
- 2 Turn on the device and analyzer.
- 3 Configure the device for GPIB operation, and determine the device's GPIB address. (You will substitute the address for <number> in one of the next two steps.)
- 4 If your hardcopy device is a plotter, press the following **[Local/GPIB]** **[PLOTTER ADDRESS]** <number> **[ENTER]**.
- 5 If your hardcopy device is a printer, press the following **[Local/GPIB]** **[PRINTER ADDRESS]** <number> **[ENTER]**.
- 6 Press **[Plot/Print]** **[PLOT/PRNT DESTINATN]** **[OUTPUT TO GPIB]**.
- 7 Press **[Rtn]** **[PLOT/PRNT DEVICE]**, then press the softkey corresponding to the type of device you have connected to the analyzer: **[HP-GL PLOTTER]**, **[RASTER PRINTER]**, or **[HP-GL PRINTER]**.

You can use one of the Agilent 10833 GPIB cables to connect the analyzer to most Hewlett-Packard plotters and printers. These cables range in length from 0.5 to 4 meters. They are available through your local Agilent Technologies, Inc. Sales and Service Office.

Refer to your hardcopy device's documentation if you do not know how to configure it for GPIB operation or determine its GPIB address. Refer to online help for more information on the parameters you are setting.

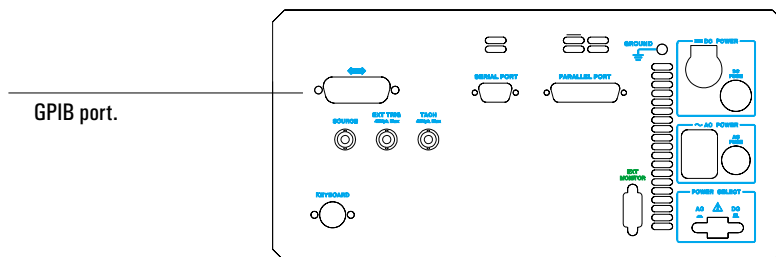

To plot screen contents

- 1 Set up your plotter if you haven't already.
- 2 If you are plotting via the GPIB port, press **[Local/GPIB]** [SYSTEM CONTROLLER].
- 3 Press **[Plot/Print]** [PLOT DATA SELECT], then press the softkey corresponding to the part of the screen you want to plot: [ALL], [TRACE], [TRACE MARKER], [MARKER REFERENCE], or [GRID].
- 4 Press **[Rtn]** [START PLOT/PRNT].

The analyzer also allows you to create a plot file on the current directory of the default disk. To do this, insert the following two steps after step 3:

- Press **[Plot/Print]** [OUTPUT FILENAME], type a file name, and press [ENTER].
- Press [PLOT/PRNT DESTINATN] [OUTPUT TO FILE].

After you have finished creating plot files, be sure to return [PLOT/PRNT DESTINATN] to its original setting so subsequent plots will be directed to the correct port. See online help for more information on the plot destination and the plot data selection.

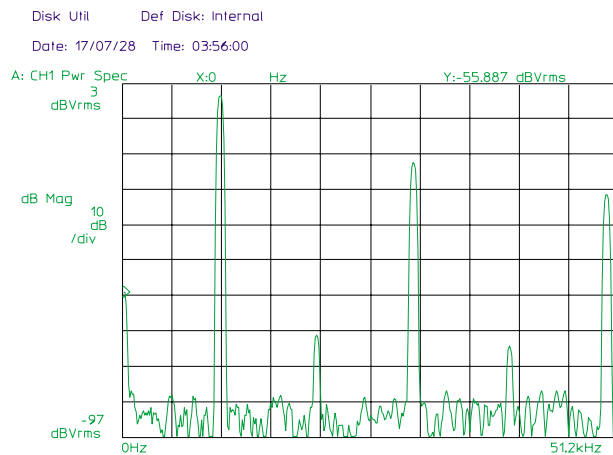

To print screen contents

- 1 Set up your printer if you haven't already.
- 2 If you are printing via the GPIB port, press **[Local/GPIB]** [SYSTEM CONTROLLER].
- 3 Press **[Plot/Print]** [START PLOT/PRNT].

All of the screen's contents, except the softkey labels, are printed when you complete this task. If you prefer to create a print file, refer to the previous task, "To plot screen contents." It describes two additional steps that you can use to direct plotting or printing to a file. You should insert them after step 2 of this task.

If you selected **[HP-GL PRINTER]** when you set up your hardcopy device, you actually print screen contents as described in the previous task. See online help for more information on HP-GL printers.

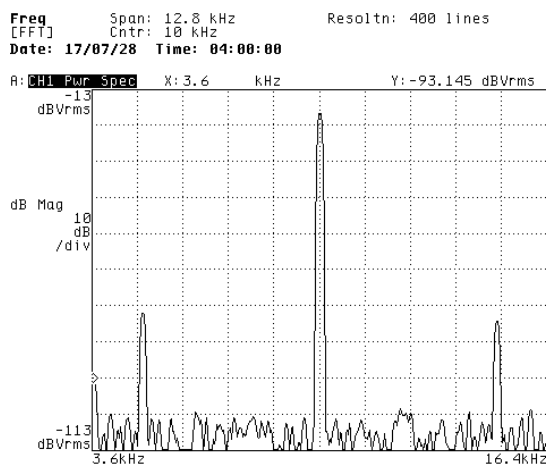

To annotate a plot or print

- 1 Press [**Plot/Print**] [MORE SETUP], then press [TITLE ON OFF] to highlight ON.
- 2 Press [TITLE LINE 1], type the first line of annotation, and press [ENTER].
- 3 Press [TITLE LINE 2], type the second line of annotation, and press [ENTER].
- 4 If you want to include the current time and date, press [TIME STMP ON OFF] to highlight ON.
- 5 Complete one of the following tasks: “To plot screen contents” or “To print screen contents.”

You can modify the format of the time stamp by pressing [**System Utility**] [CLOCK SETUP] [TIME STMP SETUP], and then pressing the softkey that corresponds to format you want to use. See online help for more information on the time stamp formats.

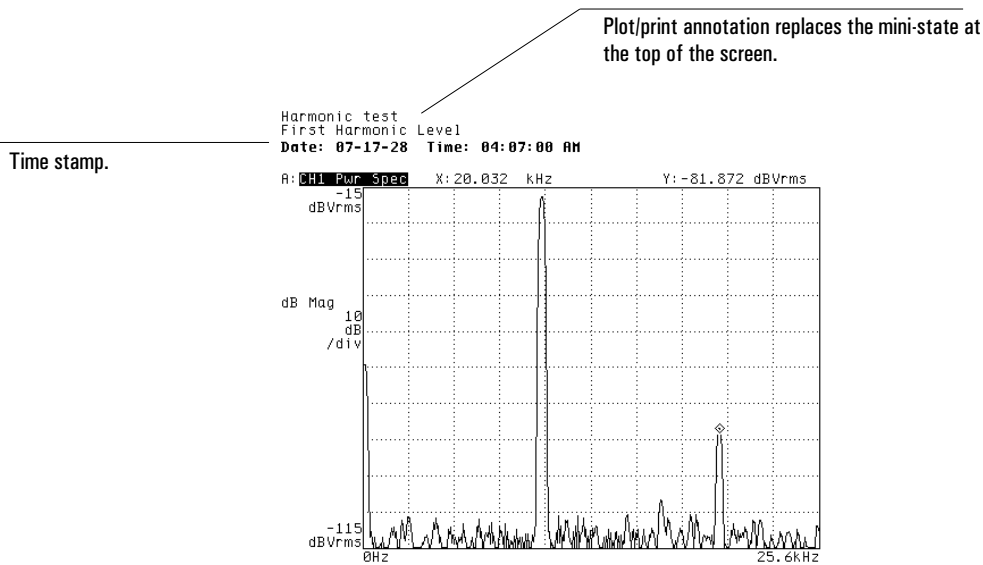

To reassign plotter pens

- 1 Press [**Plot/Print**] [PLOT PENS SETUP].
- 2 Press the softkey matching the plot component whose pen assignment you want to change.
- 3 Type the carousel number of the pen you want to use for the selected plot component, then press [ENTER].

If you are assigning different pens to the markers, you must press [MARKER PEN SETUP] after [PLOT PENS SETUP]. You can return all plot components to their default pen assignments by pressing [DEFAULT PENS].

To modify the plotting speed

- 1 Press [**Plot/Print**] [MORE SETUP] [PLOT PEN SPEED] [USER SPEED].
- 2 Press [USER PLOT SPEED], then type a speed your plotter can accept (using a unit of cm/s) and press [ENTER].

If you prefer to let your plotter select the plotting speed, press [DEFAULT SPEED] instead of [USER SPEED] in step 1, and skip step 2. Some plotters—for example, the Agilent 7550A—automatically select the best plotting speed for the type of pen being used. Check your plotter documentation to determine the range of supported plotting speeds.

To position a plot on the page

- 1 Press **[Plot/Print]** [MORE SETUP] [P1 P2 SETUP], then press [USER P1P2 ON OFF] to highlight ON.
- 2 Enter the horizontal and vertical position of the plot's lower-left corner under the [USER P1 X] and [USER P1 Y] softkeys.
- 3 Enter the horizontal and vertical position of the plot's upper-right corner under the [USER P2 X] and [USER P2 Y] softkeys.

When you plot screen contents, the plot will be positioned within the area defined in steps 2 and 3. If you prefer to position a plot using the controls on your plotter, press [USER P1P2 ON OFF] to highlight OFF in step 1, and skip steps 2 and 3. See your plotter documentation for information on selecting appropriate P1 and P2 values.

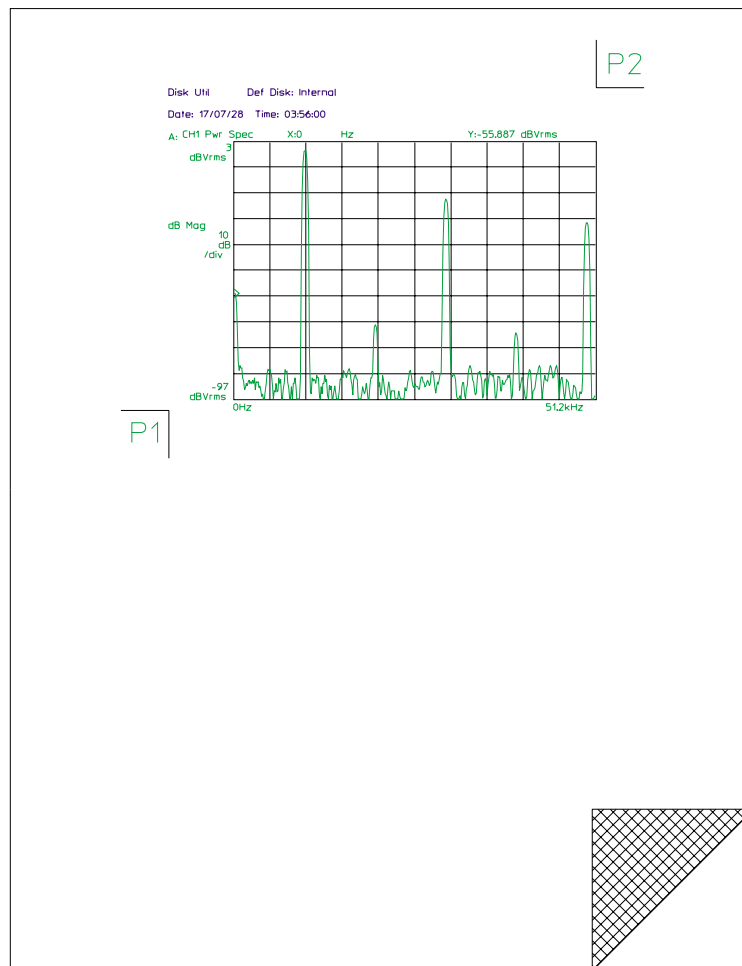

Synthesis
Option 1D3

Synthesis

The synthesis feature lets you generate frequency-response traces based on an $H(s)$ model. You can use synthesis to view the frequency response of a theoretical circuit.

Figure 15-1.

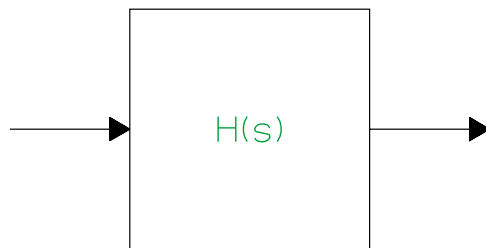

The Synthesis Model

Using the synthesis menus under the [**Analys**] hardkey, you can enter parameters from your transfer function into a synthesis table. Then the analyzer can use this synthesis table—with either the FFT Analysis mode or the Swept Sine mode—to create a frequency response trace. Once you create a synthesis table, you can store it as you would a trace or a math function.

This chapter explains how to use the synthesis features. If you need more information about a specific softkey, see online help.

The Synthesis Calculation

The synthesized trace is displayed with the X-axis in Hertz. Consequently, for $H(s)$, the parameters (such as pole positions) must be in Hertz. The synthesis equation for $H(s)$ is as follows:

$$H(s) \mid s = j\omega$$

Since Laplace transfer functions are expressed in radians and the display's X-axis is *not* in radians, it needs to be scaled to Hertz.

If you modify $H(s)$ to express it in Hertz, you must adjust the gain of $H(s)$ to keep the dc gain constant.

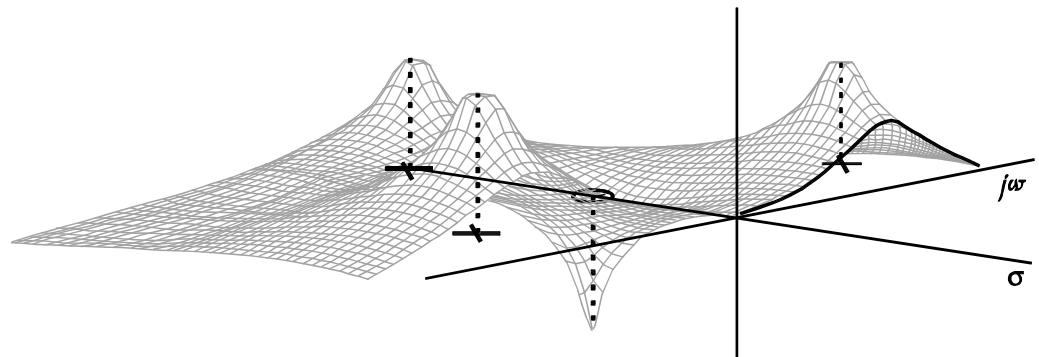

The Agilent 35670A Evaluates $H(s)$ Along the Positive $j\omega$ Axis

The Synthesis Table and Data Formats

The synthesis table contains data used by the analyzer for the synthesis operation. It contains the pole and zero (or pole/residue or polynomial) locations plus any gain, time delay, or scaling frequency parameters. The table may contain data in one of the three commonly used formats:

- Pole-zero
- Pole-residue (partial fraction)
- Polynomial

You may change the data format in a synthesis table at any time by converting the table to a different format. The Pole-Zero format is the most numerically accurate of the three formats.

The Pole-Zero Format

For pole-zero data, the synthesis table is split into two columns: the left side for poles and the right side for zeros. Poles (or zeros) can be either real or complex conjugate pairs. (The requirement of conjugate pairs means that only Hermitian symmetric pole-zero data is supported.)

Conjugate pair poles or zeros and real poles or zeros all occupy one line. Often, real poles are called “simple poles” and real zeros are called “simple zeros.”

A $\pm jB$ distinguishes a complex conjugate pair from a simple pole or zero which has no imaginary part.

A table can have a maximum of 20 poles and 20 zeros. The order is not critical. Any combination of real or complex pole-zero data can be in the table. However, if every line contains a conjugate pair, the table is limited to a maximum of 10 lines.

The Pole-Zero Equation

To express your transfer function in pole-zero format, use the following formula:

$$H(s) = K \frac{(s - Z_1)(s - Z_2)(s - Z_2^*) \dots (s - Z_n)}{(s - P_1)(s - P_2)(s - P_3)(s - P_3^*) \dots (s - P_m)}$$

- where
- * is the conjugate
 - K is the system Gain
 - P is the pole position ($-\sigma_p \pm jB_p$)
 - Z is the zero position ($-\sigma_z \pm jB_z$)

This formula is the basis for interpreting pole-zero data in the synthesis table. Pole and zero positions are in Hertz. During synthesis, the analyzer replaces s with jf (where f is frequency in Hertz).

Pole-Zero Data

This is how pole-zero data appears in a synthesis table:

$$H(s) = \frac{1 \times 10^6 (s + 600)}{(s + 250)(s + 500 - j2000)(s + 500 + j2000)}$$

where: pole and zero terms are in Hz
(thus, frequency scale = 1.0 will be used)

POLES 3	SYNTH	ZEROS 1
-250		-600
-500	$j \ 2e+3$	
TIME DELAY=0 s FREQUENSCALE=1		
GAIN=1e+06		

The Pole-Residue (Partial Fraction) Format

The pole-residue form of the LaPlace variable is most commonly used to describe mechanical resonances. For pole-residue data, the synthesis table is split into two columns: the left side for poles and the right side for residues. A residue is another name for the numerator constant for each pole term in the partial-fraction expansion.

Poles can be simple (real) or entered as a complex conjugate pair. A pole and its residue are always on the same line in the synthesis table (unlike pole-zero tables, where order doesn't matter). A $\pm jB$ distinguishes a complex conjugate pole-pair from a simple pole.

Since a complex conjugate pole-pair corresponds to two terms in a partial-fraction expansion, the residue is also interpreted as being a complex-conjugate pair.

For pole-residue data, the synthesis table can contain up to 20 lines of simple poles and simple residues. However, if the table is composed of all complex-conjugate pairs, it can only consist of a maximum of 10 lines.

The Pole-Residue Equation

To express your transfer function in pole-residue format, use the following formula:

$$H(s) = K [c_1 s^0 + c_2 s^1 + \dots + \frac{A_1}{(s - P_1)} + \frac{A_2}{(s - P_2)} + \frac{A_2^*}{(s - P_2^*)} + \frac{A_3}{(s - P_3)} + \frac{A_3^*}{(s - P_3^*)} + \frac{A_4}{(s - P_3)^2} + \frac{A_4^*}{(s - P_3^*)^2} + \dots]$$

where:

- * is the conjugate
- K is the system Gain
- P are the pole positions
- A are the residues (a constant, possibly complex)
- c terms caused by numerator order \geq denominator order

This formula is the basis for interpreting pole-residue data in the synthesis table. Pole positions are in Hertz. During synthesis, the analyzer replaces s with jf (where f is frequency in Hertz). If the same pole (real or conjugate) is entered more than once, the pole term is surrounded by parenthesis and its order is indicated by n , where n is the multiplicity. There are no c terms if the numerator order is less than the denominator order.

For pole-residue, the values in the synthesis table must be identical in order to be identified as a multiple order pole. Thus, if you convert the synthesis table from polynomial to pole-residue format, then add a pole that appears to be the same, it probably won't be identified as the same pole due to rounding errors in the conversion.

Pole Residue Equations

This pole residue equation results from the partial-fraction expansion of a corresponding pole-zero equation.

Pole-zero equation:

$$H(s) = \frac{1 \times 10^6 (s + 600)}{(s + 250)(s + 500 - j2000)(s + 500 + j2000)}$$

Pole-residue equation:

$$H(s) = \frac{86.154}{s + 250} + \frac{-43.077 - j244.62}{s + 500 - j2000} + \frac{-43.077 + j244.62}{s + 500 + j2000}$$

Reconstructing Simple Poles

To reconstruct the pole-residue equation from the synthesis table, you must associate poles with their residues. Poles and their residues are always on the same line in the synthesis table.

The equation for a simple residue over a simple pole is:

$$\frac{\text{(Residue)}}{s - \text{(Simple Pole)}}$$

where:

(residue) is the real residue in the table and its sign

(simple pole) is the real pole and its sign shown
in the table across from the residue

Placing a complex conjugate residue over a simple pole creates a non-Hermitian symmetric transfer function. These should not be synthesized. Also, table conversions are not allowed. The message "Not Hermitian" is displayed if coefficients from Pole Residue synthesis-tables are in a table when table format conversion is attempted. The analyzer's curve fitter will not work with a non-Hermitian frequency-response trace (because it is not possible for our pole-zero format to have non-Hermitian table entries).

Reconstructing Complex Conjugate Pole-Pairs

For pole-residue tables, the sign of the imaginary part of a complex residue is now significant because of the assumptions the analyzer makes about the conjugated pole pair. Unlike complex pole terms, the imaginary part of a complex residue can have a sign.

The formula for a complex residue over a complex pole is:

$$\frac{(\text{Residue, real part}) + j(\text{Residue, imaginary part})}{s - (\text{Pole, real part}) - j(\text{Pole, imaginary part})} \text{ (first conjugate term)}$$

$$+ \frac{(\text{Residue, real part}) - (\text{Residue, imaginary part})}{s - (\text{Pole, real part}) + j(\text{Pole, imaginary part})}$$

where:

(real part) is the real number and its sign

(imaginary part) is the imaginary number and its sign; for poles, consider it positive

Associating the sign of the imaginary part of a complex residue with the First Conjugate Term establishes the sign convention for the imaginary part of the complex conjugate pole-pair. The second conjugate term is formed by conjugating the residue and pole in the First Conjugate Term.

In the case of a simple (real) residue over a complex conjugate pole-pair, the formula used is:

$$\frac{(\text{Residue})}{s - (\text{Pole, real part}) - j(\text{Pole, imaginary part})}$$

$$+ \frac{(\text{Residue})}{s - (\text{Pole, real part}) + j(\text{Pole, imaginary part})}$$

where:

(residue) is the real residue in the table and its sign

(real part) is the real number and its sign

(imaginary part) is the imaginary number and its sign; for poles, consider it positive

In this case, the residue has no imaginary part. Thus, there is no sign association between the residue and the complex conjugate pole-pair. If you are synthesizing displacement or acceleration in a spring-mass-damper system, residues are imaginary, that is the real part is zero. If you are synthesizing velocity, the residue is real.

The following tables show how to reconstruct the First Conjugate Term for all possible sign entries in the synthesis table. Since both the real and imaginary parts of the residue can be minus, there are four possible table entries for residues (see table 15-1). Since only the real part of the pole can be minus, there are only two possible table entries for poles (see table 15-2). Table 15-1 shows the numerator constant and table 15-2 shows its denominator for example table entries.

Table 15-1.

Reconstructing the First Conjugate Term: Residue

Table Entry	Numerator Constant (residue)
.5 ±j 1.0	.5 + j 1.0
-.5 ±j 1.0	-.5 + j 1.0
-.5 ±j -1.0	-.5 - j 1.0
.5 ±j -1.0	.5 - j 1.0

Table 15-2.

Reconstructing the First Conjugate Term: Pole

Table Entry	Denominator (pole)
.6 ±j 2.0	s - .6 - j2.0
-.6 ±j 2.0	s + .6 - j2.0

Pole-Residue Data

This is how pole-residue data appears in a synthesis table:

$$H(s) = \frac{(86.154)}{s - (-250)} + \frac{(-43.077) + j(-244.62)}{s - (-500) - j(2000)} + \frac{(-43.077) - j(-244.62)}{s - (-500) + j(2000)}$$

$$H(s) = \frac{86.154}{s + 250} + \frac{-43.077 - j244.62}{s + 500 - j2000} + \frac{-43.077 + j244.62}{s + 500 + j2000}$$

(first conjugate term)

Analysis

Synth Result: D8

POLES 3	SYNTH	RESIDUES
-250	86.154	
-500 j 2e+3	-43.077 j -244.62	
TIME DELAY=0 s		GAIN=1
FREQUENCY SCALE=1		

The table contains the following:

- One simple pole and an associated simple residue
- One complex conjugate pole-pair and an associated complex conjugate residue

You can generate the *second conjugate term* by conjugating the *first conjugate term*.

The Polynomial Format

Synthesis using the Ratio-of-Polynomials format is called polynomial. For polynomial data, the synthesis table is split into two columns: the left side for the numerator polynomial and the right side for the denominator polynomial. Table entries are interpreted as coefficients of the s polynomial.

The first line in the synthesis table corresponds to the numerator and denominator coefficients for s^0 , the second line corresponds to s^1 , and the nth line corresponds to s^{n-1} .

A 20th-order polynomial is the highest-order polynomial entry in the synthesis table.

The Polynomial Equation

To express your transfer function in polynomial format, use the following formula:

$$H(s) = K \frac{(a_1s^0 + a_2s^1 + a_3s^2 + \dots + a_ns^{n-1})}{(b_1s^0 + b_2s^1 + b_3s^2 + \dots + b_ms^{m-1})}$$

where:

K (first conjugate term) is the system Gain

This formula is the basis for interpreting polynomial data in the synthesis table. Polynomial coefficients are in Hertz. During synthesis, the analyzer replaces s with jf (where f is frequency in Hertz).

The Polynomial Ratio

The following is the polynomial ratio of a pole-zero transfer-function equation.

Analysis

Synth Result: D8

NUMERATOR	SYNTH	DENOMINATOR	
600e+6	s^0	1.062e+9	s^0
1e+6	s^1	4.5e+6	s^1
		1.25e+3	s^2
		1	s^3
TIME DELAY=0 s		GAIN=1	
FREQUENCY SCALE=1			

$$\text{Pole - zero equation: } H(s) = \frac{1 \times 10^6 (s + 600)}{(s + 250)(s + 500 - j2000)(s + 500 + j2000)}$$

$$\text{Polynomial equation: } H(s) = \frac{1.0 \times 10^6 s + 600 \times 10^6}{s^3 + 1.25 \times 10^3 s^2 + 4.5 \times 10^6 s + 1.062 \times 10^9}$$

Converting Data Formats

As mentioned, the data in a synthesis table may be in pole-zero, pole-residue, or polynomial format. You can convert from one data format to another.

In pole-residue tables, the $1s^0$ residue term appears when you convert an empty table (interpreted as $H(s) = 1$) to the pole-residue format. This term simply adds a "1" to the synthesis equation. An s^n term is called a Laurent term. Laurent terms cannot be edited on the synthesis table. If you do not need to use the $1s^0$ residue term, clear the table.

In a polynomial table, the default $1s^0$ term appears when you convert an empty table to the polynomial format. These terms simply put a "1" in both the numerator and denominator of the synthesis equation. If you don't need to use the default $1s^0$ terms, clear the table.

Avoid converting tables unnecessarily. Table conversions are not exact because of finite precision (64-bit) in the math operations. It may not always be possible to convert from one representation to another and back, without resulting in slight variations.

The numeric range for tables is full IEEE 64-bit double precision. The display of numbers only handles floats.

When you synthesize a function with infinite gain at dc (such as K/S^2) and place a zero in the DC bin, the marker reads NaN, which means "Not a Number."

The message "Not Hermitian" is displayed if coefficients from Pole Residue or Polynomial synthesis-tables are in a table when table format conversion is attempted. The analyzer's curve fitter will not work with a non-Hermitian frequency-response trace (because it is not possible for real-world systems to be non-Hermitian).

To display a synthesis table — Pole-Zero Format

- 1 Press [Analy] [SYNTHESIS].
If you do not already have an existing table in the pole-zero format, press [CONVERT TABLE] [CONVRT TO P OLE ZERO].
- 2 Press [TABLE ON OFF] to highlight ON.

The left column contains poles, the right column contains zeros.

- Poles (or zeros) can be either real (simple) or complex conjugate pairs.
- A $\pm jB$ distinguishes a complex conjugate pair from a simple pole or zero.

Avoid converting tables unnecessarily.

POLES 3	SYNTH	ZEROS 1
-250		-600
-500 $\pm j 2e+3$		
TIME DELAY=0 s		GAIN=1e+06
FREQUENCY SCALE=1		

To select/convert a table format — Pole-Residue format

- 1 Press [**Analys**] [SYNTHESIS] [CONVERT TABLE].
- 2 Press [CONVRT TO POLE RESD].
- 3 Press [TABLE ON OFF] to highlight ON.

The left column contains poles and the right column contains residues.

The $1s^0$ residue term appears when you convert an empty table (interpreted as $H(s)=1$) to the pole-residue format. If you do not need to use the $1s^0$ residue term, clear the table.

Avoid converting tables unnecessarily.

POLES 3	SYNTH	RESIDUES
-250		86.154
-500 $\pm j$ 2e+3		-43.077 $\pm j$ -244.62
TIME DELAY=0 s		GAIN=1
FREQUENCY SCALE=1		

To select/convert a table format — Polynomial format

- 1 Press [**Anals**] [SYNTHESIS] [CONVERT TABLE].
- 2 Press [CONVRT TO POLYNMIAL].
- 3 Press [TABLE ON OFF] to highlight ON.

The left column contains the numerator polynomial and the right column contains the denominator polynomial. Table entries are interpreted as coefficients of the s polynomial. The n th line corresponds to s^{n-1} .

The default **1s⁰** term appears when you convert and empty table to the polynomial format. If you don't need to use the default **1s⁰** terms, clear the table.

Avoid converting tables unnecessarily. Table conversions are not exact because of finite precision in the math operations.

NUMERATOR	SYNTH	DENOMINATOR
600e+6	s ⁰	1.062e+9
1e+6	s ¹	4.5e+6
		1.25e+3
		1

s⁰

s¹

s²

s³

The first line corresponds to the numerator and denominator coefficients for s⁰.

The second line corresponds to s¹

The nth line corresponds to sⁿ⁻¹

TIME DELAY=0 s	GAIN=1
FREQUENCY SCALE=1	

Creating a Synthesis Table

You can enter data into a synthesis table at any time. You must be in either the FFT Analysis instrument mode or the Swept Sine instrument mode to do a synthesis calculation.

Entering Data

In a pole-zero table, you can enter up to 20 poles and 20 zeros or 10 conjugate pole-zero pairs. The order is not critical. You can enter any combination of real or complex pole-zero data. However, if every line contains a conjugate pair, you can only enter a maximum of 10 lines. The requirement of conjugate pairs means that only Hermitian symmetric pole-zero data is supported.

In a pole-residue table, you can enter up to 20 lines of simple poles and simple residues. However, if you enter all complex-conjugate pairs, you can only enter up to 10 lines.

In a polynomial table, the highest-order polynomial entry you can make to the synthesis table is a 20th-order polynomial.

Entering a Gain Factor

You can enter an optional parameter to set the gain of the synthesized frequency response function. The default value for the gain factor is 1.0. The gain factor appears at the bottom of the table.

Using a Gain Factor

The following example shows you how to use the gain factor to synthesize a 20 kHz low-pass filter (single pole).

$$H(jf) = 1 / (s + 20000)$$

The equation shows a pole (in pole-zero format) at -20 kHz. You would enter a pole in pole-zero format at -20 kHz. It also yields a pass band gain (at 0 Hz) of 1/20000 (-86 dB). To obtain a gain of 0 dB, you would enter a gain factor of 20000. This changes the equation to:

$$H(jf) = 20000 / (s + 20000)$$

Now the gain is 1 (0 dB) at 0 Hz.

How To Keep the dc Gain Constant

To keep the dc gain constant for pole-zero or polynomial transfer functions, adjust the gain by a factor of $(2\pi)^{(n - m)}$, where n is the order of the numerator, and m is the order of the denominator.

To keep the dc gain constant for pole-residue transfer functions, you must adjust the gain for each term in the partial-fraction-expansion. For a simple pole, this means dividing the residue by 2π . For a complex-conjugate pole pair, this means dividing the residue by $(2\pi)^2$.

Entering a Time Delay

When necessary, you can enter a time delay for a synthesis calculation. Time delay can be used to simulate computational delay in a sampled system or transport delay. Negative delays correspond to an advance.

The delay can be in terms of microseconds (uS), milliseconds (mS), or seconds (S). The default is 0 seconds, which has no effect on the synthesis. If you enter a non-zero time delay (t), the H(s) synthesis includes multiplication by:

$$e^{-j2\pi ft}$$

Where:

f is frequency in Hertz

t is time delay

The time delay appears at the bottom of the table. A delay in the time domain will appear as a linear phase ramp in the frequency domain plots.

Entering a Frequency Scale

This factor scales the frequency axis (the X-axis) by:

$$\frac{f}{\text{freq scale}}$$

where:

f is frequency in Hertz

freq scale is the scale frequency

The frequency can be entered in Hz; the range is 10^{-6} to 10^{+6} . The default value is 1 Hz/Hz (that is, unitless, even though the units key is used to complete numeric entry). If you have polynomial coefficients in radians, you can scale the frequency by $1/2\pi$ to avoid dividing by $(2\pi)^n$ to obtain proper X-axis scaling.

If you want the frequency axis to be in radians, enter a scale frequency of $1/(2\pi)$. The enter parameters for H(s) in terms of radians (even though the unit keys still say mHz, kHz, and Hz). The frequency axis is always labeled Hz (Hertz); however, the X-axis cursor would not be interpreted as radians. Units are not displayed by frequency scale in the synthesis table because this is a frequency scaling operation, and hence has units such as Hz/Hz, Hz/kHz, or Hz/mHz.

Using the Scale Frequency

The scale frequency feature can be used to scale pole-zero data from radian per second to Hz by setting the scaling value to $1/(2\pi)$. The following are identical:

Hz	Scale Frequency
Pole at -1	1

Radians	Scale Frequency
Pole at -6.28318	0.159155

The pole is entered as -6.28 Hz but with frequency scaling set to $1/(2\pi)$, the pole will appear to be at - 1 Hz, which is - 6.28 radians.

To create a synthesis table

- 1 Press [**Analys**] [SYNTHESIS].
- 2 Select the table format. See the previous tasks.
- 3 Press [EDIT TABLE].
In the first column, enter <number><unit>.
If the entry is a complex conjugate pair,
press [+j] to designate the imaginary part of the complex pair.
- 4 Use the knob to move the highlighted bar to the left column.
Enter <number><unit>.
If the entry is a complex conjugate pair,
press [+j] to designate the imaginary part of the complex pair.
- 5 To enter additional table entries, use the knob to move the highlighted bar and repeat steps 2 and 3.
- 6 If you make a mistake, move the highlighted bar over the entry you want to change.
Press [CHANGE VALUE] <number><unit>.
- 7 Press [**Rtn**].

The maximum number of table entries is dependent upon the table format. See “Entering Data” in the previous section.

To add a gain factor, time delay, and frequency scale to the synthesis calculation

- 1 Create and display a synthesis table.
- 2 Press [SYNTHESIS SETUP].
- 3 Press [GAIN FACTOR] <number>.
- 4 Press [TIME DELAY] <number> <unit>.
- 5 Press [FREQUENCY SCALE] <number> <unit>.

POLES 3	SYNTH	ZEROS 1
-250		-600
-500 $\pm j 2e+3$		
TIME DELAY=0 s		GAIN=1e+06
FREQUENCY SCALE=1		

Optional parameters appear at the bottom of the table.

You must enter these parameters before creating the synthesized frequency response trace.

To clear a synthesis table

- 1 Press [EDIT TABLE].
- 2 Press [CLEAR TABLE], then press [CONFIRM CLEAR].

Caution

You cannot recover a table after it has been cleared. For more information, see online help.

Performing the Synthesis

After data is entered in a synthesis table, you are ready to perform the synthesis. Analyzer configuration affects the synthesis frequency span and the X-axis data spacing of the synthesis trace.

The analyzer uses the frequency-span set up for measurements to determine the synthesis start and stop frequencies. For example, you could set the span to 12.8 kHz with a start frequency at 0 Hz. Once you set the start and stop frequencies, you do not have to set them for subsequent synthesis calculations.

Synthesis data spacing for the X-axis can be either linear or logarithmic. Set the X-axis spacing before performing the synthesis. The default setting is linear.

The synthesized trace is stored in a data register and displayed in the active trace when the synthesis is complete.

To synthesize a frequency response curve

The analyzer plots the synthesized frequency response data on the active traces. In this task, the magnitude is displayed on trace A and the phase is displayed on trace B. The analyzer must be in FFT Analysis or Swept Sine instrument modes.

1 Create and display a synthesis table.

See the previous task, "To create a synthesis table."

Press [TABLE ON OFF] to highlight OFF.

2 Set up the active traces.

Press [**Active Trace**] [A B].

Press [**Meas Data**], [MORE CHOICES], [DATA REGISTER], [D8].

3 Specify the measurement frequency span.

Press [**Freq**] [START] <number> <unit>, then press [STOP] <number> <unit>.

4 Configure the display.

Press [**Active Trace**] [B].
 Press [**Trace Coord**] [PHASE].
 Press [**Active Trace**] [A B].
 Press [**Scale**], then press[AUTOSCALE ON OFF] to highlight ON.

5 Start the synthesis.

Press [**Analys**] [SYNTHESIS][START SY NTHESIS].

You can also recall a previously saved synthesis table or transfer a curve fit table in Step 1.

The analyzer stores the results of the synthesis in the selected data register, D8, and automatically displays it in the active trace. Trace A is the default. Step 2 adds Trace B as an active trace and specifies the data in D8.

If you do not set the start and stop frequencies in step 3, the analyzer uses the frequency-span set up for measurements. Once you set the start and stop frequencies, you do not have to set them for subsequent synthesis calculations.

To change the synthesis data spacing for the X-axis, see the next task.

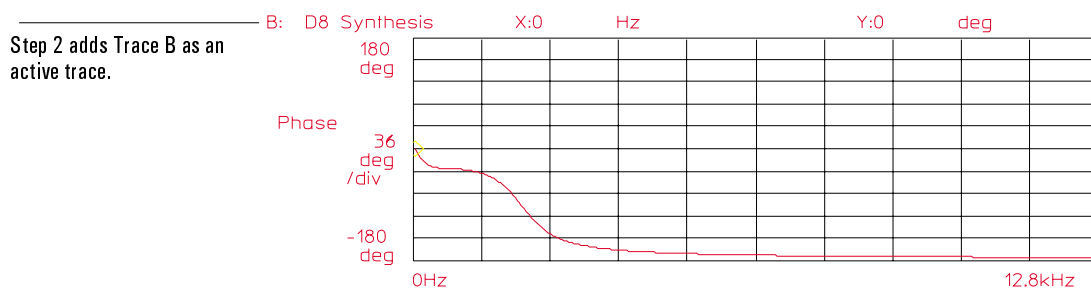

To change the data spacing for the X-axis

- 1 Press [SYNTHESIS SETUP].
- 2 Press [X-AXIS LIN LOG] to highlight LIN.
or
Press [X-AXIS LIN LOG] to highlight LOG.

LIN specifies linear spacing (the default setting); LOG specifies logarithmic spacing. You must specify the spacing before performing the synthesis.

Working With Synthesis Tables

Once you create a synthesis table, you can edit it, save it, and later recall it. The synthesis trace is stored in a dedicated register (data register D8 is the default register, though you can change this). You can run the synthesis without saving the trace. However, the data register is overwritten the next time you create a new synthesis trace.

Caution

The data registers are cleared when you turn off the analyzer. Save the data register to a file before you power-down or it will be lost.

A few hints about editing synthesis tables:

- When editing curve fit data, it is easier to remove poles and their associated gain value in pole-residue form.
- When deleting a pole in a pole-residue table, you must delete both the pole and its corresponding residue.
- If you accidentally delete a table entry, use the [UNDELETE KEY] key to restore it.

The numeric range for tables is full IEEE 64-bit double precision. Note that the display of numbers only handles floats. You can observe full precision by moving the highlighted bar over any term with “infnty” and pressing [ADD VALUE]. Double precision is then given in the numeric entry window.

To edit an existing synthesis table

- 1 Press [**Analysis**] [SYNTHESIS].
- 2 Display the current synthesis table.
Press [TABLE ON OFF] to highlight ON.
- 3 Press [EDIT TABLE].
- 4 To add a value to the synthesis table,
press [ADD VALUE] <number><unit>.
- 5 To delete a value, use the knob to move the highlighted bar over the entry you want to delete,
press [DELETE VALUE].
If you make a mistake, press [UNDELETE VALUE].
- 6 If you want to change or correct a value, move the highlighted bar over the entry you want to modify.
Press [CHANGE VALUE] <number><unit>.

In step 1, you can recall the synthesis table or transfer a curve fit table.

To save a synthesis table

- 1 Specify the default disk. (See “To select the default disk” in chapter 13, “Saving Your Work.”)
- 2 Press [**Save Recall**] [SAVE MORE] [SAVE SNTH TABLE].
- 3 Using an external keyboard (or the front-panel alpha keys), type an appropriate filename. The default is SYNT1.SYN.
- 4 Press [ENTER].

You should use the .SYN suffix to delineate synthesis files from other types of files.

You can store a synthesis table into the analyzer's non-volatile RAM (NVRAM), RAM or internal disk. Step 1 specifies where you store the synthesis table. You can also store a table to an external disk via the GPIB. For more information, see *GPIB Programming with the Agilent 35670A*.

To save a synthesis trace

- 1 Specify the default disk. (See “To select the default disk” in chapter 13, “Managing Files and Disks.”)
- 2 Press [**Save Recall**] [SAVE DATA] [SAVE TRACE][INTO FILE].
- 3 Using an external keyboard (or the front-panel alpha keys), type an appropriate filename. The default is TRAC1.DAT.
- 4 Press [ENTER].

This task stores a synthesis trace into the analyzer's non-volatile RAM (NVRAM), RAM or internal disk. Step 1 specifies where you store the synthesis trace.

Caution

The data registers are cleared when you turn off the analyzer. Save the contents of a data register to a file before power-down or it will be lost.

The synthesis trace is automatically stored in a dedicated data register. The default register is D8. To change the data register, see “To change the synthesis register.”

To recall a synthesis table

- 1 Specify the default disk. (See “To select the default disk” in chapter 13, “Managing Files and Disks.”)
- 2 Press [**Save Recall**], then press [CATALOG ON OFF] to highlight ON.
- 3 Press [RECALL MORE] [RCL SYNTH TABLE].
- 4 Using the knob, highlight the filename you want to recall.
- 5 Press [ENTER].

You can recall a synthesis table from the analyzer's non-volatile RAM (NVRAM), RAM or internal disk. Step 1 specifies where the synthesis table is stored. You can also recall a table from an external disk via the GPIB. For more information, see *GPIB Programming with the Agilent 35670A*.

To transfer a curve fit table to a synthesis table

- 1 Press [**A**nalysis] [SYNTHESIS].
- 2 Press [TABLE ON OFF] to highlight ON.
- 3 Press [COPY FROM CURVE FIT].

The curve fit table transfers as a pole-zero format synthesis table. The analyzer's curve fitter does not work with a non-Hermitian frequency-response trace because it is not possible for our pole-zero format to have non-Hermitian table entries.

Any values already in the synthesis table are erased when the curve-fit table is copied.

To change the synthesis register

- 1 Press [**Analys**] [SYNTHESIS] [SYNTHESIS REGISTER].
- 2 Press [D1]
or
Press [D2]
or
Press [D3]
or
Press [D4]
or
Press [D5]
or
Press [D6]
or
Press [D7].

The synthesis trace is stored in a dedicated data register. The default register is D8. The data for the trace is saved as real and imaginary values versus frequency. Therefore, you do not need to save magnitude and phase to two separate data registers.

If you change the synthesis register, your selection is stored in RAM. If you preset the analyzer, the selection returns to the default data register, D8.

Curve Fit
Option 1D3

Curve Fit

The curve-fit feature lets you find a mathematical model—using up to 20 poles and 20 zeros—to closely approximate the frequency response obtained from a measurement or from a synthesis. After performing a curve fit, you can view the pole-zero results either in a curve fit table or a synthesized trace.

This chapter explains how to use the curve-fit features and steps through some basic tasks common to many curve-fit procedures. If you need information about a specific softkey, see online help.

What is Curve Fitting?

Curve fitting is a powerful analytical tool that is used to obtain coefficients for a function that best fits the measured frequency response. With curve fitting, you start with a frequency response trace and find a linear model that corresponds to that trace.

Curve fitting is often done in conjunction the analyzer's math functions. Math functions let you combine multiple transfer function traces together to simulate cascaded systems.

Curve fitting derives a linear system model from either measured or synthesized frequency response data. The pole/zero model is developed by calculating a weighted least-squares fit of the frequency response data to a rational polynomial. You can curve fit using frequency response data obtained with the analyzer's FFT Analysis mode or Swept Sine mode.

Curve fitting with the Agilent 35670A is done in the s-domain. This means that the curve fitter finds H(s) models, where s is a complex variable with units of Hz, not radians. This is of the form:

$$H(s) = K \frac{(a_1s^0 + a_2s^1 + a_3s^2 + \dots a_ns^{n-1})}{(b_1s^0 + b_2s^1 + b_3s^2 + \dots b_ms^{m-1})}$$

where:

K is the system Gain

Once a curve fit is complete, the numerator polynomial and denominator polynomial are factored to obtain poles and zeros. Only real coefficients are found for the polynomials. Hence, the roots of the polynomials (poles and zeros) appear as real terms and complex conjugate pairs. The results are tabulated in the curve-fit table.

Using Real Measurement Data In Curve Fitting

Real measurement data can make it difficult to evaluate the curve fit accuracy because you do not know where the system poles and zeros are. Repeated roots and heavily damped poles can “hide” behind lightly damped poles. To compound the problem, real data has noise, bias errors, nonlinearities and the associated distortion. Linear coefficients deal with the realities of measured data. The curve fitter in the Agilent 35670A has been optimized to handle these experimental realities. Numerical instability (non-convergence) and fitting poles and zeros to measurement noise have been eliminated or minimized.

The curve fitter can produce numbers that are questionable, however. You must still provide the proper engineering judgement in evaluating the results. Even though the curve fit operation contains expert-system-tools to eliminate many of the more common fitting problems, some minor extraneous pole and zeros will get through.

To obtain a minimum order system with maximum accuracy in the model, you must start with good, quality measurements. Random noise is the recommended test stimulus and measurements with a coherence value of 0.9999 are recommended.

Curve Fit Operating Modes

The curve fitter has two operating modes:

- Fixed Order
- Max Order

In fixed order, the curve-fit routine uses only the user-specified numerator and denominator order. The analyzer develops a model (with a particular fixed order) with a frequency response that best approximates the complex data in a least-squares sense.

In max order mode, the curve-fit routine uses successively larger system orders until it finds the best fit—or until the maximum system order is reached. Both the maximum numerator order (number of zeros) and the maximum denominator order (number of poles) can be specified.

Fixed Order Mode

Fixed Order Theory

The fundamental component of the curve-fit feature is a non-iterative least-squares complex data fitter. In fixed order, the number of zeros and poles specified under the [CURVE FIT SETUP] menu define the numerator and the denominator order for the complex data fitter. Unlike max-order mode, different numerator and denominator orders are *not* used in an attempt to find an accurate fit. Fixed order allows you to manually experiment with different orders. You can trade-off model complexity (orders) for accuracy. Higher order models can be more accurate.

Very accurate frequency response matches between the measurement and the curve-fit model are only possible when the order of the curve-fit model is greater than—or equal to—the order of the measured system. Measurement errors from noise and distortion make accurate curve fitting more difficult. Thus, fixed order lets you control the curve-fit model's order when max order has difficulty finding a satisfactory model.

The complex data fitter is deterministic in nature. Therefore, if you repeat a curve fit in fixed order—using the same data and setup parameters—you will obtain the same answer.

Fixed Order Operation

After initial pole-zero estimates are completed, the complex data fitter uses your system order to find a pole-zero curve-fit model with a frequency response that matches—as closely as possible, in a least-squares sense—the measured frequency response. Since no search for an optimal order is performed, this operation is quite short. The two status lines at the top of the display briefly indicate “fit running” and the current order selection.

When the fit is complete, a synthesis of the curve-fit model appears in Trace B. The status line returns to its idle state.

Max Order Mode

Max Order Theory

Max order mode is the default mode. In max order mode, the max order algorithm operates the complex data fitter (from now on, simply called the *curve fit routine*) with successively larger system orders until it finds a good model, or until the maximum system order is reached. Both the maximum numerator order (number of zeros) and the maximum denominator order (number of poles) can be specified. For example, entering 3 for the numerator upper bound restricts the max order algorithm to finding a model that has a maximum of three zeros.

The max order algorithm starts with a numerator/denominator order of 1,1 and does a fit using the curve-fit routine given this order. The max order algorithm automatically performs a synthesis on the fit model and compares this frequency response to the measured frequency response. If the fit is poor, the orders are incremented to 2,2, and another fit is done. This search upwards in order continues until a good match is found or the upper bounds are reached. The upper bounds do not have to be equal. The max order algorithm holds the order at the first upper bound reached, and lets the other order climb to the higher order if the fits are poor. If both upper bounds are reached before a good fit is found, the max order algorithm returns the fit which came closest to the measured frequency response.

When the curve fitter finds a good fit, the max order algorithm tries to reduce the numerator order and denominator order if it determines that this may create a lower-order model that still provides a close match to the measured frequency response. This order reduction usually results in a numerator order lower than the denominator order.

The max-order algorithm uses the coherence function. Coherence is a function that represents the amount of output signal power due to the input stimulus. Its value ranges from one (1) which is perfect, to zero (0) which is no coherence (any value less than 0.9999 should not be considered “good”). Coherence is a function of variance, which normally is derived from the multiple measurements that occur during averaging.

The max-order algorithm uses the coherence function to determine how large the difference can be between the synthesis of the fit model and the measured frequency response in defining a good fit.

Once the analyzer finds a good fit, the numerator and denominator polynomials from the fit are factored into pole/zero form. (If none of the fits meet the “good” criterion, the analyzer returns a fit with minimum error.) Then, the max-order algorithm searches for coincident poles and zeros that cancel each other. Coherence determines how close terms need to be before cancellation can occur. The final results are tabulated in the curve-fit table.

Max Order Operation

The curve fitter obtains starting estimates of the system poles and zeros by looking for peaks in the second derivative of the real and imaginary values of the measured frequency response. When this operation is finished, the max order algorithm starts with an order 1,1 fit (1 pole and 1 zero). The result is placed in trace B, overwriting the coherence. If the fit is not good, the max order algorithm does an order 2,2 fit and places the result in trace B, overwriting the order 1,1 fit. The current orders are displayed in the upper two status lines as the fit order increases.

When there's a good fit, the max order algorithm checks to see if a reduced order may yield a good fit. This process is called order reduction. Order reduction can lower an order by more than one. If a fit with reduced order results in too large an error, the max order algorithm increments the order and tries another fit. The order is repeatedly incremented (to no higher than where the order was before order reduction began) until there's a good fit. If the incremented order yields a good fit, the max order algorithm again checks to see if order reduction is possible. Occasionally, this causes the curve fitter to repeat two fits. Otherwise, order reduction successively reduces the fit order(s), and then finishes the search process after determining that further order reduction probably won't yield an acceptable fit. Some example sequences for reduction are shown in table 16-1.

Table 16-1.

Example sequences for curve-fit order reduction

Example 1	Example 2
(poles,zeros)	(poles,zeros)
5,5	6,6
5,3	6,1
5,1	6,2
complete	6,3
	6,2
	6,3
	complete

When the max order algorithm finishes order reduction, it factors the polynomial-ratio fit into poles and zeros. Then a search is done on the pole and zero terms to determine if any pole-zero pairs are close enough to each other to be cancelled. The cancellation routine uses the coherence value to estimate the accuracy of the pole-zero pairs. That is, are the pairs in a measurement range where there are poor signal-to-noise values. If terms can be cancelled, the result display (trace B) is updated with a synthesized transfer function from the remaining poles and zeros. The poles and zeros remaining after cancellation (or all the poles and zeros from factoring if no cancellation occurs) are placed in the curve-fit table along with the gain found.

How Max Order Defines a Good Fit

To prevent the max order algorithm from always searching to the upper bounds, a variance function is used to establish an error tolerance that gives the max order algorithm some margin when fitting contaminated data.

The max order algorithm uses the number of averages and the coherence function to calculate a variance function on the measurement. (For more information about the relationship between coherence and curve fitting, see "Special Considerations" later in this chapter). The max order algorithm calculates an error-to-signal level, and compares this to a noise-to-signal level. When the error-to-signal level drops below the noise-to-signal level, the fit is defined as good. As a rough approximation, each 0.9 in the coherence function corresponds to -10 dB in the noise-to-signal level.

For example, 0.99 corresponds to a noise level at 20 dB below the signal level, and 0.9999 corresponds to a noise level at 40 dB below the signal level. Since the computed variance is used, rather than the coherence function, these figures are merely presented as typical—additional averaging lowers the measurement noise level in the noise-to-signal level calculation.

The curve-fit routine calculates a pseudo coherence when fitting to swept sine measurements (swept sine measurements are available with Option 1D2). Measurement coherence in swept sine is much higher than obtained with FFT-based measurements. Swept sine measurements are also more susceptible to bias, noise and nonlinearity errors. A pseudo coherence allows for a more realistic error tolerance in the presence of nonlinearities.

Choosing an Operating Mode

If you know your system order ahead of time, you can specify the number of poles and zeros and perform a fixed-order curve fit. For example, if you want to model your system with two poles, and no zeros, enter 2 for the denominator order (), and 0 for the numerator order () and perform a fixed-order curve fit. Fixed order will create a 2 pole, 0 zero model that is as close as is possible (in a least-squares sense) to the measured frequency response.

A model for the system you are measuring is ideal, however, and the real system may have resonances or other parameters that correspond to additional poles and zeros. Consequently, you may need to allow for higher orders in your curve fit model. Thus, beginning with an max order curve fit with upper bounds on the system order set several orders (3 or 4) above where you think a reasonable order exists for your system, allows the max order algorithm to automatically find a linear model which comes close to your measured frequency response. You will find that if nonlinearities exist in the measurement, the curve fitter will try to find extra poles and zeros to give a response to closely approximate the effects of nonlinearities on the frequency response.

Typically, you want your model to contain a small number of poles and zeros in order to be practical to work with. Thus, if measurement nonlinearities cause the curve-fit orders to climb unacceptably high, you may want to either lower your system bounds and start the max order curve fit over again, or return to fixed-order curve fitting.

Fixed order is useful when max order returns an overly complex model. For example, the max order fit may increment the system order beyond a point at which you feel the accuracy of the fit has become acceptable. If this happens, you can set the system orders at the point where you saw a good fit and perform a fixed-order fit to find that model. Afterwards, you can try lower numerator orders with fixed order as a way of manually performing order reduction.

The max order algorithm is essentially an expert system that uses the curve-fit routine as a tool to try and find a good answer. When Max order does not provide an acceptable answer, you can turn to fixed order and use the curve-fit routine directly to experiment with different system orders until you find a reasonable model.

Obtaining a Good Model

The fundamental assumption in curve fitting is that the measured frequency response corresponds to a finite-order rational-polynomial (linear) model. There are several challenges involved in making accurate measurements which fulfill this assumption, and in utilizing measurements inevitably subject to contamination and finite frequency span to obtain reasonable models.

There are three basic sources of data errors in frequency response measurements that prevent any curve-fit algorithm from easily finding a linear model:

- Nonlinearities
- Noise
- Quantization Errors

Nonlinearities

Frequency response measurements may be contaminated by distortion products introduced by system nonlinearities. This contamination can cause the max order algorithm to search for sufficiently high system orders to compensate for these errors in the fit model. For example, although a measured system may contain only 4 poles and 3 zeros, errors may perturb the frequency response enough to look like a system with 10 poles and 10 zeros. In other words, there is no way in which the max order algorithm can differentiate between measurement errors and correct data (fixed order will also do its best to fit measurement errors with the numerator order and denominator order you set).

The type of test stimulus you use determines the success of averaging to reduce the impact of nonlinearities on the curve fitting. Broadband stimuli are used for FFT Analysis mode. There are two different types of broadband stimuli used in this analyzer:

- random noise
- periodic chirp

If a truly random source is used (that is, *random noise* or *burst random*), nonlinearities will cause distortion products to randomly appear across the measurement span. Therefore, averaging reduces the effects of nonlinearities on the frequency response measurement, and results in a linear least-squares estimate of the system frequency response.

When using the continuous *random noise* source, you must apply a Hann window to the time-domain data to reduce leakage in the frequency domain. However, multiplication in the time domain corresponds to convolution in the frequency domain. This means that the frequency response is convolved with the Fourier transform of the Hann window, which produces slight frequency smearing (the main lobe of the window is approximately three bins in width). This frequency smearing can affect measurements on systems with sharp peaks in the frequency response such as those seen in mechanical resonances—frequency smearing bias errors increase the apparent damping of the poles. Thus, a better measurement results if you use the *burst random* source with *source trigger* and a *uniform window* (burst random is a self-windowing stimulus when source trigger is used). The Fourier transform of a *uniform window* has a narrower main lobe than that of a Hann window—this provides the best resolution bandwidth possible for a given span.

The other broadband source available is *periodic chirp*. This source type is completely predictable in that it provides exactly the same stimulus from one measurement average to the next. Thus, nonlinearities produce the same distortion products with each average. Consequently, averaging is of no value in reducing the effects of nonlinearities when a periodic-chirp source is used. In addition, the periodic-chirp source makes coherence very high, giving a false impression of a good measurement when nonlinearities may be significant. The periodic-chirp source works best when the system under test is reasonably linear.

One difficulty with using broadband stimuli in some systems is that a signal which is sufficiently strong to provide good signal-to-noise ratios over one portion of the measured span may be too strong for another portion, causing excessive distortion—and possibly rendering the system-under-test inoperable.

The Swept Sine mode (Option 1D2) can provide a solution to this problem. Stimulating the system with a sine wave allows for control of the signal level at a single frequency (rather than broadband noise) over the frequency response measurement. The *autolevel* feature can be used to automatically adjust the source level, as the sweep progresses, to maintain a constant reference level on one of the input channels. Typically, the input channel chosen as the reference is the channel connected to the output of the system under test. With this configuration, the output of the system is held constant rather than the input. This reduces the overall level of distortion while maintaining the signal-to-noise ratio.

The swept-sine algorithm tends to reject distortion products (harmonics) caused by system nonlinearities. However, nonlinearities can also cause errors in the measurement of the fundamental frequency (the frequency of the source sine wave). You can examine the nonlinear behavior by doing two or more sine sweeps at different source levels and compare the measured results. The magnitude of the change indicates how nonlinear the system is. Another symptom of measurement nonlinearities that can be observed using the max order mode of the curve fitter, is a failure of the curve fitter to stop incrementing system orders after the fit appears to be very good. This can occur on FFT based measurements as well.

Another way to check for nonlinearities is to stimulate the system with a fixed frequency sine wave (in FFT Analysis mode; in Swept Sine mode, you can define a math function to compute the FFT of channel 2 time data) and observe the linear spectrum in the response channel. If harmonic distortion is evident in the spectrum, then the system contains some form of nonlinearity.

Detecting Bias Errors

The bias errors around complex poles are best detected by looking for narrow width decreases in the coherence function at the peak of a resonance.

These bias errors can occur in measurements made with a burst random source if the burst is not shut-off soon enough. The system response must be allowed to decay to near zero by the end of the time record.

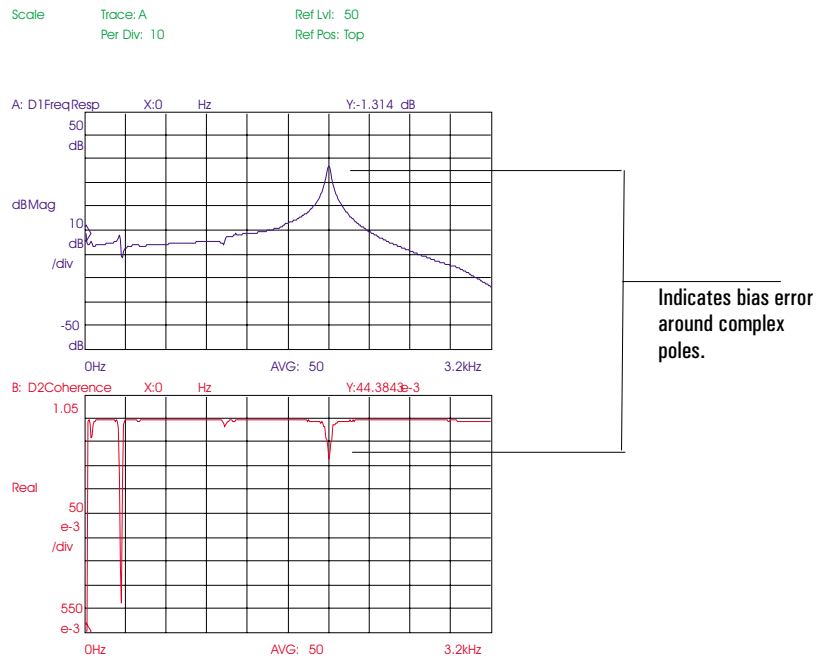

Noise

Noise will introduce measurement errors. As in the case of distortion products, the curve fitter cannot differentiate measurement errors introduced by noise from correct data. The effects of noise on FFT-based measurements can be minimized by averaging measurements, or for swept sine measurements, by using longer integration times. This assumes that the noise source is uncorrelated to the stimulus (source type) used.

To completely remove errors due to unwanted noise and nonlinearities would theoretically require an infinite number of averages. Since this is not practical, you must choose a compromise. Thus, some error is always present. Averaging reduces the variance of each point in the frequency response measurement as the number of averages increases.

The curve-fit routine uses coherence (coherence is calculated from the tri-spectrum averaging process) and the number of averages to estimate the variance on the measurement. The variance is then used as an estimate of the mean error on the measured transfer function. This information is used to improve the accuracy of curve fitting in the presence of noise. Additionally, the max order algorithm uses the calculated measurement variance to determine how close the curve fit must come to the measured frequency response to be considered a “good” fit. See the sidebar called “How Max Order Defines a Good Fit” earlier in this chapter.

Quantization Errors

Quantization error—better described as *quantization distortion* rather than *quantization noise*—is present whenever an analog signal is digitized. Quantization distortion can be averaged, as can distortion caused by system nonlinearities. The dithered 16-bit A/D converter in the Agilent 35670A provides a tightly-specified spurious-free dynamic range of greater than 80 dB (90 dB typical).

For curve fitting, this specification is of lesser significance. The curve fit uses the complete frequency response, with very strong emphasis on peaks in the magnitude response. Thus, one or two spurs 80 - 90 dB down will have a negligible effect on the fit. With averaging, the typical noise floor may be in excess of 80 dB below the top of your input range.

To minimize quantization errors, remember not to allow a measurement under-range condition when measuring in the FFT Analysis mode. To ensure that the top of your “80 dB range window” is as close as possible to the peak signal strength, press the appropriate autorange softkey under the [Input] menu. *These precautions are not necessary in Swept Sine mode because in this mode, the analyzer performs optimal input ranging.*

Limitations of a Finite Measurement Span

Curve fitting is performed over a finite portion of the theoretical frequency response. Unexpected out-of-span poles and zeros may be required to provide an accurate fit inside the measurement span. For example, a typical op-amp has an open-loop response that begins to roll-off between 10 kHz and 100 kHz due to a single pole. Closing the loop pushes this roll-off farther out (for example, to 150 kHz). Thus, an active filter may be designed to have two poles, but is actually affected by another pole farther out. This may be accounted for in a curve fit, but it depends upon the max order curve-fit error tolerance (determined by the measurement variance) and the size of the effect.

The Fit Region

Overview

Curve fitting is always done over a finite range of frequencies. This is referred to as the fit region. The curve fitter (whether in max order or fixed order) attempts to match the measured frequency response in the fit region. The entire frequency response trace displayed on the analyzer is used as the fit region if you select [FULL SPAN] under [FIT REGION]. If you select [USER SPAN] however, the start and stop frequencies under the [FIT REGION] menu determine the fit region.

User span is useful when a fit over the entire frequency response trace does not provide an acceptable fit over some part of the response. For example, the fit may be very good about a sharp resonance, but may begin to diverge from the measurement as the response dips into higher noise regions. If this region is important, you can use user span to restrict the fit region to that portion of the measurement trace where you need a closer match between the fit and the measurement. If this still doesn't provide a good fit, auto weight may not be sufficiently emphasizing the region of importance. In this case, use *user weight* to emphasize the region of importance. Use data edit to set a value (for example, 0.5) to the weighting function over the portion to be emphasized.

Deciding if a Pole or Zero Is Necessary

Measurement distortion, bias errors and nonlinearities can cause poles and zeros that may not be necessary for an accurate model. You can change the fit region, the data range used in the curve fit, and re-fit the measurement.

System poles and zeros that repeat between the two curve fit operations are valid and should be retained. In addition, poles and zeros that are nearly equal in frequency may be deleted and still produce a model of usable accuracy.

Behavior of the Fit Outside the Fit Region

The max order algorithm finds only those poles and zeros needed to provide a good match to the measurement over the fit region. Thus, the frequency response of the curve-fit model outside the fit region tends to follow the behavior of the response near the boundaries of the fit region. The curve fitter inserts simple poles or complex-conjugate pole pairs (or zeros) outside the fit region as needed to obtain a good fit to the response inside the fit region. Poles and zeros found outside the fit region usually result in a gradual drop-off in the response. You can use the [FIT TO SYNTH] softkey to synthesize the frequency response over the entire measurement span to evaluate the model accuracy outside of the fit region.

Understanding the Effects of Poles and Zeros Outside the Fit Region

With the following example, you can see the effect that poles and zeros outside the fit region have on the response inside the fit region. We will take the poles and zeros shown in figure 16-1, synthesize them over a span of 25.6 kHz, and fit the data over a smaller region (1.28 kHz to 3.2 kHz).

The poles and zeros shown in figure 16-1 are the same poles and zeros used in chapter 16 (“Synthesis”), with an additional zero at 65 kHz and a pole at 45 kHz. The additional pole and zero are both outside the fit region but have a small effect on the response inside the fit region. This small effect is not sufficient for the curve fitter to identify the pole at 45 kHz and the zero at 65 kHz—however, the effect is sufficient for the curve fitter to compensate with a new zero, to replace the pole at 45 kHz and zero at 65 kHz. The curve fit result is shown in figure 16-2. Although the pole-zero models look quite different, figure 16-3 shows the frequency responses to be nearly the same over the fit region.

Figure 16-1.

POLES 3	SYNTH	ZEROS 2
-250		-600
-500e+3		-65e+3
-45e+3		
TIME DELAY=0 s		GAIN=1e+06
FREQUENCY SCALE=1		

Synthesis Model with Extra Pole and Zero

Figure 16-2.

POLES 2	FIT	ZEROS 2
-52.269e+3		-97.087e+3
-250.01		-600.03
TIME DELAY=0 s		GAIN=1.5553
FREQUENCY SCALE=1		

Small Fit Region on a Synthesis With a Pole And Zero Outside the Fit Region

Curve Fit Option 1D3

Figure 16-3.

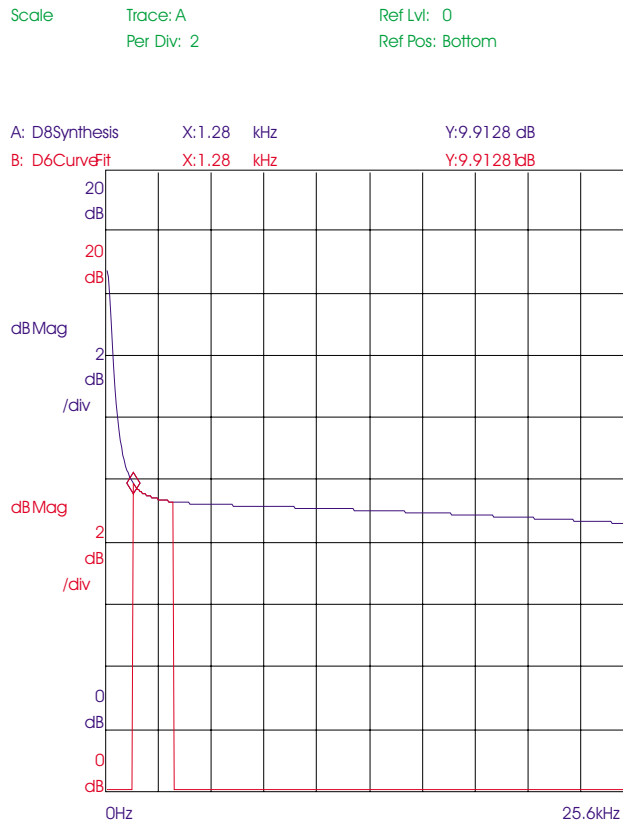

Curve Fit with Restricted Fit Region Overlaid With a Synthesis

To make this easier to understand, consider the fit we used in this example. As the order of the trial curve fit increased, the curve fit trace was too far away from the synthesized trace to be considered a good fit. When the order reached 2 poles and 2 zeros, the curve fitter found a model whose frequency response inside the fit region was sufficiently close to the synthesis trace to be considered good. At this point, the analyzer used order reduction to try and minimize the numerator order, but without success—in other words, given a limited picture of the complete frequency response, the analyzer found an alternative model that was sufficiently accurate over the fit region.

A comparison of the synthesis model and curve fit model over 51.2 kHz more clearly shows the divergence between the two responses. This is shown in figure 16-4. You can generate this display by changing the span to 51.2 kHz and doing the synthesis with Trace A active. Then copy the curve fit table to the synthesis table, change the synthesis register to D7, and do the synthesis with Trace B active. Then change to the front/back display format. (If the pole at 45 kHz and the zero at 65 kHz are not present, a curve fit over 1.28 kHz to 3.2 kHz will yield the original model, as shown in figure 16-5.)

Figure 16-4.



Comparison of Curve Fit and Synthesis

Figure 16-5.

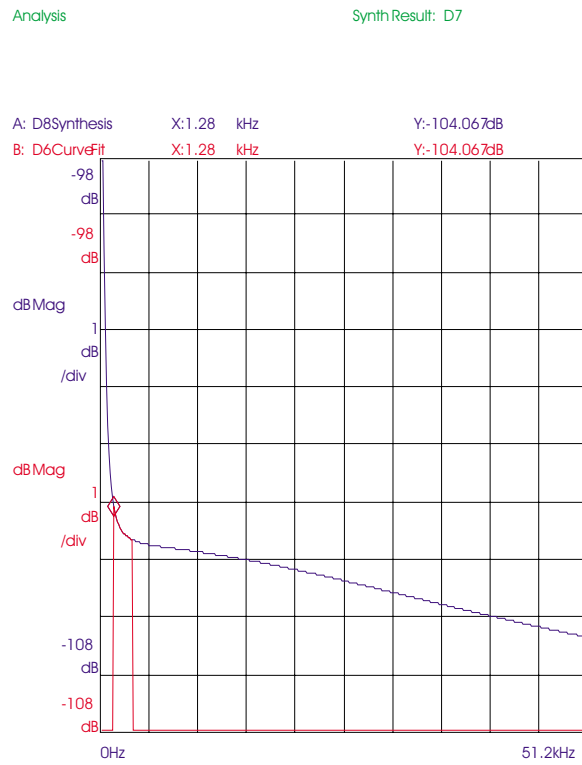

Curve Fit over Smaller Region Yields the Original Model

Special Considerations

Why Coherence is Important for Curve Fitting

Coherence is a function of frequency. Each frequency point in the coherence function is a real value between 0.0 and 1.0. A value of 1.0 implies that noise does not contaminate the measurement at that frequency. Averaging allows the measured coherence to converge on the true coherence, which is a measure of the noise in the system, not the measurement. The value of the coherence function is different with different test stimulus. If you use a chirp signal as the stimulus, the coherence function measures signal-to-noise relationships. If you use random noise as the test stimulus, the coherence function measures the signal-to-noise relationship and distortion. At each frequency point, the coherence and the number of averages are used to compute the measurement variance. The measurement variance is the indication of the noise level in the measurement data. Additional averaging gives a better estimate of the coherence and a smaller measurement variance. Thus, as the coherence at a specific frequency converges to a value farther below 1.0, additional averaging is needed to obtain a small measurement variance at that frequency.

You can improve curve fit results by reducing the measurement variance across the fit region. As an example, if the average value of the coherence across the fit region is 0.9995, only 10 averages may be needed to obtain a good fit. However, if the average value of the coherence drops to 0.95, then 200 averages may be needed for a good fit.

When the Analyzer Uses Coherence Data

The analyzer uses coherence data (if available) for the curve fit procedure. However, you must have coherence data displayed on Trace B for the analyzer to use it.

Also, keep in mind that coherence data is not available when:

- the analyzer is in Swept Sine mode (The analyzer automatically calculates a variance in Swept Sine mode.)
- the data is synthesized
- the measured data is the result of fewer than four averages

The Weighting Function

Like coherence, the weighting function is a real-valued function of frequency which varies between 0.0 and 1.0. The weighting function is used to emphasize important areas of the curve region during a curve fit and to de-emphasize areas of high variance. The weighting function can be automatically calculated from measured data, or you can create your own weighting function manually.

When you use *auto weight*, the curve-fitter automatically derives a weighting function based on an initial estimate of pole-zero locations and on the variance function. The auto-weighting algorithm tends to emphasize low frequencies and peaks. Thus, as the frequency increases, the emphasis is on resonances (complex poles) rather than simple poles that may change only the rate of amplitude roll-off. This weighting function is placed in the selected weight register during the curve fit.

When you use *user weight*, the curve fitter uses the weighting function stored in the selected weight register. A typical application of user weight is to modify a weighting function created in a previous curve fit using *auto weight*.

When a curve fit using auto weight is finished, you can use data edit to modify the contents of the data register selected as the weight register. Then select user weight and re-run the curve fit. The curve fitter *does not* modify the weight register when user weight is selected.

For synthesized data, the weighting function is not critical to obtaining a good fit, so the auto-weighting algorithm creates a weighting function which has a value of 1.0 at all frequencies.

Under most circumstances the auto-weighting algorithm creates an acceptable weighting function. When the curve fit result doesn't match the measured frequency response in an area that you consider important, it is probably because the auto-weighting algorithm has de-emphasized that portion of the response. In this situation, the best approach to obtaining an acceptable fit is to edit the existing weighting function and try higher weighting values.

How Coherence Affects the Weighting Function

The max order algorithm uses the number of averages and the coherence function to calculate a variance function on the measurement. Regions of high variance (low coherence, depending upon the number of averages) are not emphasized in the weighting function when you use auto weighting. Also, regions of low variance are not necessarily emphasized: the weighting function only emphasizes regions around peaks and frequencies near dc if the variance is low.

Fitting Measurements With Delay

The curve fitter can have trouble finding a model when pure delay is present in the measurement. A delay implies an infinite number of poles at dc.

Any pure delay in a system affects the phase of the frequency response without affecting its magnitude. If these delays are known, they should be entered into the curve fit table before starting a curve fit. Delays can occur in real data from sampled systems or from transport delay in real systems. Pure delays cannot be modeled with a finite-order rational polynomial in the s domain. For more information on the effects of excess phase refer to product note Agilent 3562A-3, *Curve Fitting in the Agilent 3562A*.

Fixed Poles and Zeros

You have the option to enter and “fix” known system poles and zeros. The known pole-zeros can be obtained from curve fitting a compensator gain block or from some synthesized analytical data combined with the measurement data. When poles or zeros are fixed, the curve fitter assumes they are correct and includes them as starting values in the next fit. Any pole or zero manually added to the curve-fit table is also tagged as fixed. A fixed term is indicated by “fxd” to the right of the term. The fixed line feature allows the results of one curve fit to be included in the results of another. For example, a curve fit could be performed on a narrow region around a resonance. The resonant pole from this fit would be fixed and another curve fit performed on the entire frequency span. Pole and zero locations found in the first fit and set as fixed are retained and used in the second fit. This approach is useful in speeding up the curve fitting process and improving fit accuracy.

To Obtain the Best Curve Fit Results

Start by making the best frequency response measurement possible. This is very important.

- Select a source type and window function to minimize leakage and distortion. Use a Burst Random or Burst Chirp source with a Uniform window, or a hammer with a Force-Exponential window, or Swept Sine. Adjust source magnitude for the most linear operating region.
- In all but the Swept Sine instrument mode, use as many averages as possible. Ideally, the coherence function should be near unity at all frequencies of interest.
- Choose the frequency span to cover the smallest range of interest. Make separate measurements on each region of interest, if possible. Avoid cases where the band of interest is in a very narrow region of the chosen span, if at all possible. Also, avoid large zoom factors. Baseband measurements are easiest to fit. A rule of thumb is to have at least 8 spectral lines across the half-power band width of a resonance. You should not allow more than 0.2 dB change from one frequency bin to the next frequency bin in the measured data. A smaller Δf (line spacing), will usually fix both problems.

Unless previous experience indicate otherwise, use the Auto Weighting function and the Max Order mode. Then watch the fit quality and the corresponding orders.

Note the orders that give the best fit, and then specify these in the Fixed Order mode for a closer inspection. Also, small changes in the fit region will not affect the dominate poles and zeros, but may alter extraneous ones.

Always allow a few more poles and zeros than the expected number, to help take care of tails from out-of-band poles, and from other sources of noise, distortion, and interference. These extra roots will often cancel one another in the curve fit table. The valid roots are usually fairly obvious by comparing the table entries to the original data. Do not be concerned about right half-plane poles if there are matching right half-plane zeros. If a pole is removed, the gain constant must be readjusted by dividing by the negative of the pole value. Likewise, if a zero is removed, multiply the gain constant by the negative of the zero value. If matching pole-zero values are removed it is good practice to resynthesize the fit, to be sure that it is still acceptable (transfer the curve fit table to the synthesis table and adjust the gain constant, if necessary).

(Continues on next page)

To Obtain the Best Curve Fit Results (continued)

It is important to specify any pure time delay that exists in the measured data, so that the curve fitter can remove this delay before attempting a fit. Otherwise, it may be difficult to obtain a good fit, even with a large number of poles and zeros. Excess phase due to the right half-plane zeros should not cause any fitting problems, as long as enough zeros are allowed in the order selection step.

Occasionally, you can adjust the weighting function to improve the fit in regions where the weighting function is increased. Generally, the cleanest data should be weighted the most, and this is often near the peaks of the frequency response function.

If some of the pole and/or zero values are known, like those at the origin, for example, then those should be entered as fixed. However, be certain that they are correct or else the curve fitter will be confused.

It is possible for the fit to be good, but for some of the poles and/or zeros to be incorrect. This can happen if more than one pole-zero configuration gives the same frequency response function, within the limits of the noise level.

It is necessary to have sufficient frequency resolution to adequately represent the true response function. The frequency resolution should be less than the reciprocal of the time duration of the impulse response of the system under test. Thus, the minimum spacing between poles and zeros should be several frequency sampling intervals, or else the curve fitter does not have adequate information for a good fit. The solution is either to make a cleaner measurement, or to reduce the frequency span to improve frequency resolution.

Overview of Curve Fit Procedures

Although you do not have to follow these exact steps, the following sequence is typical for a curve fit procedure. You can repeat these steps, as needed, to obtain the best fit.

After reading this overview, you can use the following task to set up a curve fit. To learn more about the material covered in this overview, review the first part of this chapter.

- *Choose the source of the data.* The analyzer fits the frequency response data displayed in Trace A and places the synthesis of the resulting fit model in Trace B. For best results when curve fitting data measured in the FFT Analysis mode from random noise test stimulus, the curve fitter should use coherence data. Keep in mind that you must have coherence data assigned to trace B—before starting the curve fit—for the curve fitter to use it. (After a fit, the analyzer displays the model in trace B. You have to display coherence data in trace B for subsequent curve fits.)
- *Select max order or fixed order.* If you do not know the orders, use the max order mode. Max order mode uses the specified number of poles and zeros as upper bounds for an automated search for a good fit. If you want a model with a predetermined number of poles and zeros, use the fixed-order mode.
- *Specify the system order (number of poles and zeros).* In max order mode, the curve fitter experiments with successively larger orders until either a good fit is found or until your specified denominator (poles) or numerator (zeros) order is reached. If your bounds are reached, the best fit found is given. In fixed-order mode, no search is performed. The curve fitter returns a model with the number of poles and zeros you specified. Max order is a good starting point with unknown data.
- *Specify the frequency scale (optional).* The analyzer scales the frequency axis (the X-axis) by:

$$\frac{f}{\text{freq scale}}$$

where:

f is frequency in Hertz
freq scale is the scale frequency

The frequency can be entered in Hz; the range is 10^{-6} to 10^{+6} . The default value is 1 Hz/Hz (that is, unitless, even though the units key is used to complete numeric entry).

If you want the frequency axis to be in radians, enter a scale frequency of $1/(2\pi)$. Then enter parameters for $H(s)$ in terms of radians (even though the unit keys still say mHz, kHz, and Hz). The frequency axis is always labeled Hz (Hertz); however, the x-axis cursor should now be interpreted as radians. Units *are not* displayed by frequency scale in the curve fit table because this is a frequency scaling operation, and hence has units such as Hz/Hz, Hz/kHz, or Hz/mHz.

- *Specify the fit region (optional).* You can specify a *user span*—a fit region that is smaller than the measurement span. In full span, all measurement data from Trace A is used in the curve fit. Sometimes, you may want to use only a portion of measurement data. For example, you may want to exclude some resonances or regions suspected of heavy distortion. In this case, you can specify a user span—a fit region that is smaller than the measurement span. Smaller fit regions speed up the fitting process.
- *Add known poles and zeros to the curve fit table (optional).* You can edit the curve fit table to add known poles and zeros before you start the curve fit procedure. For example, if your system contains an integrator, add a pole at 0 Hz. This term will be fixed, with an “fxd” indication to the right of the term. Subsequent fits include fixed terms in the model. The number of pole and zeros set in step 3 must be larger than the order of fixed terms—this provides the degree of freedom in the fit.
- *Enter any known delays.* Any pure delay in a system affects the phase of the frequency response without affecting its magnitude. If these delays are known, they should be entered into the curve fit table before starting a curve fit. Pure delays cannot be modeled with a finite-order rational polynomial in the s domain.

- *Specify the weighting function mode (optional).* In auto weight, the curve fitter automatically derives a weighting function based on an initial estimate of pole locations and on the variance functions—the curve fitter then places this weighting function in the selected weighting register. The weighting function is used to emphasize important areas of the curve during a curve fit and to de-emphasize areas of high variance. You can use *user weight* to use a weighting function of your own choosing. The selected weighting register is used as the weighting function during the curve fit. Thus, the weighting register is not overwritten during the procedure.
- *Perform the curve fit.* See “To perform a curve fit” which appears later in this chapter.
- *View the curve fit table (and edit if necessary).* See “To edit a curve fit table” which appears later in this chapter.

To set up a curve fit

Although you do not have to do these steps in the sequence shown here, the following sequence is typical for a curve fit procedure.

1 Choose the source of the data.

Press [**Active Trace**] [A]

Press [**Meas Data**] [FREQ RESP]

Press [**Active Trace**] [B]

Press [COHERENCE].

Make a frequency response measurement to characterize your device-under-test.
(See “To measure a frequency response” in chapter 4.)

2 Specify the system order.

Press [**Analys**] [CURVE FIT].

Press [CURVE FIT SETUP].

Press [ORDER MAX FIXED] to highlight MAX, then press [**Rtn**].

3 Specify the fit region.

Press [FIT REGION].

Press [FULL SPAN].

Press [**Rtn**].

4 Add known poles and zeros.

Press [TABLE ON OFF] to highlight ON.
Press [EDIT TABLE]
[ADD VALUE] <number><unit>.

5 Add known delays.

Press [CURVE FIT SETUP].
Press [TIME DELAY] <number><unit>.

Be sure to read “Overview of Curve Fit Procedures” which precedes this task. You can repeat these steps, as needed, to obtain the best fit. See “To setup a curve fit —manual operation.”

To specify a weighting function of your own choosing, see “To specify a weighting function,” which appears later in this chapter.

Disp Fmrat

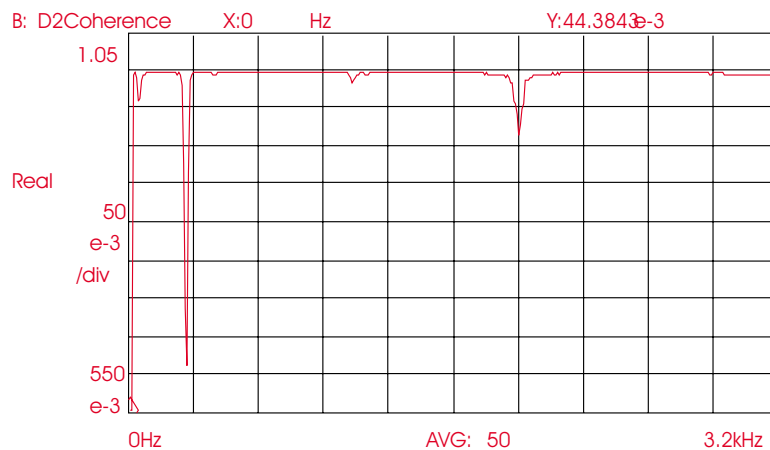
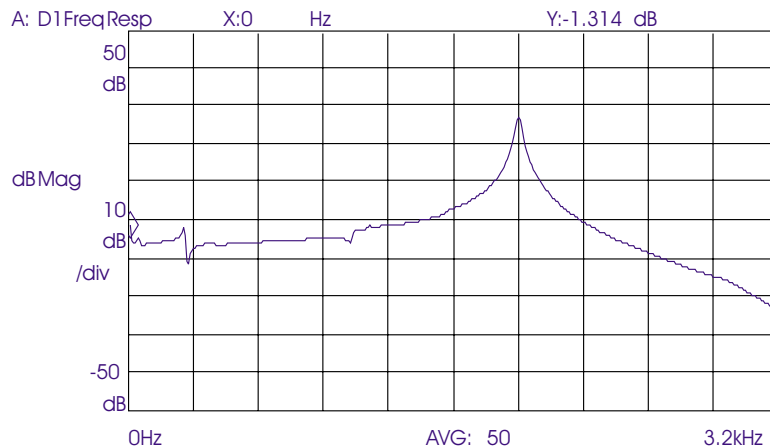

To specify a weighting function

- 1 Press [Analys] [DATA EDIT] [EDIT D7].
- 2 Press [START X] <number> <unit>.
- 3 Press [STOP X] <number> <unit>.
- 4 Press [MODIFY START Y] <number> <unit>.
- 5 Press [MODIFY STOP Y] <number> <unit>.

The weighting function is stored in a dedicated data register. The default register is D7. If you change the weighting register, your selection is stored in RAM. If you preset the analyzer, the selection returns to the default data register, D7.

Caution

The data registers are cleared when you turn off the analyzer. Save the data register to a file before power-down or it will be lost.

The curve fitter *does not* modify the weight register when user weight is selected. For more information, see “The Weighting Function,” presented earlier in this chapter.

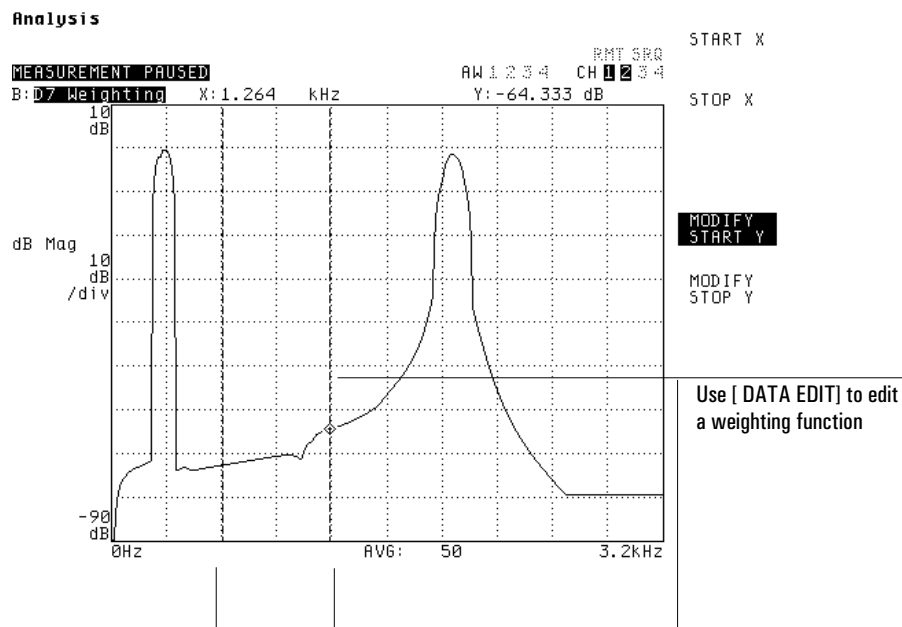

To perform a curve fit

- 1 Setup the curve fit.
- 2 Press [Analys] [CURVE FIT] [START FIT].
- 3 To overlay the results, press [Disp Format] [SINGLE FRNT/BACK].
- 4 To view the curve fit table, press [TABLE ON OFF] to highlight ON.

The curve fit table displays the number of poles and zeros that the curve fitter selected to characterize the original frequency response measurement.

The curve fitter does not use coherence data for the curve fit calculation unless you have coherence assigned to trace B. The analyzer replaces coherence data with the curve fit trace after the initial pole-zero and variance calculations are completed.

If you overlay the results in step 3, the vertical scaling for trace B is automatically set to match trace A.

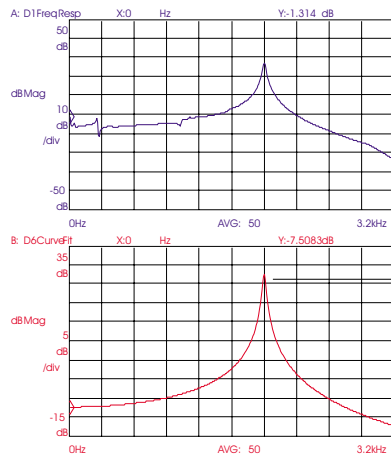

Curve Fit trace appears in Trace B.

Use [SINGLE FRNT/BACK] to overlay results.

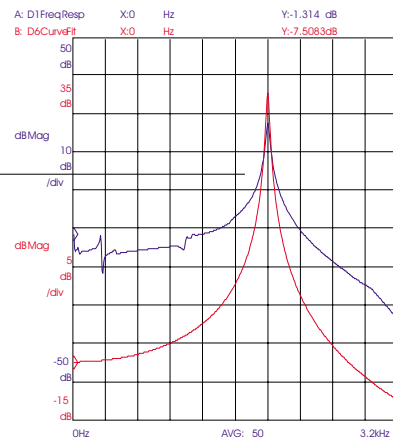

To set up a curve fit — manual operation

Once you have a curve fit using the analyzer's automatic features and you have identified fit problem areas, you may want to run another curve fit operation, setting parameters manually, to ensure the best fit.

1 Choose the source of the data.

Press [**Active Trace**] [A]

Press [**Meas Data**] [FREQ RESP]

Press [**Active Trace**] [B]

Press [COHERENCE].

Make a frequency response measurement to characterize your device-under-test. (See "To measure a frequency response" in chapter 4.)

2 Specify the system order.

Press [**Analys**] [CURVE FIT].

Press [CURVE FIT SETUP].

Press [ORDER MAX FIXED] to highlight MAX.

Press [NUMBER POLES] <number> [NUMBER ZEROS]<number>.

or

Press [ORDER MAX FIXED] to highlight FIXED.

Press [NUMBER POLES] <number> [NUMBER ZEROS]<number>.

3 Specify the frequency scale.

Press [FREQUENCY SCALE] <number>, [ENTER], then press [**Rtn**].

4 Specify the fit region.

Press [FIT REGION].
Press [FULL SPAN].

or

Press [USER SPAN], [START] <number> <unit>, then press [STOP] <number> <unit>.
Press [**Rtn**].

5 Add known poles and zeros.

Press [TABLE ON OFF] to highlight ON.
Press [EDIT TABLE]
[ADD VALUE] <number><unit>.

6 Add known delays.

Press [CURVE FIT SETUP].
Press [TIME DELAY] <number><unit>.

7 Specify the weighting function.

Press [WEIGHT AUTO USER] to highlight AUTO.
or
Press [WEIGHT AUTO USER] to highlight USER.

Be sure to read "Overview of Curve Fit Procedures" which precedes this task. Steps 3, 4, 5, 6, and 7 are optional.

Analysis		Strt: (Trace A)	Maximum Poles: 20		
		Stop: (Trace A)	Maximum Zeros: 20		
MEASUREMENT PAUSED				AW 1 2 3 4	RMT SRQ CH 1 2 3 4
POLES 2	FIT	ZEROS 0			
-16.142 ± j 1.918e+3					
TIME DELAY = 0 s		GAIN = 1.5498e+06			
FREQUENCY SCALE = 1					

START FIT

ABORT FIT

CURVE FIT REGISTER

EDIT TABLE

COPY FROM SYNTHESIS

FIT REGION

CURVE FIT SETUP

TABLE ON OFF

Working with Curve Fit Tables

Once you create a curve fit table, you can compare the synthesized results to the original frequency response measurement.

You can save and later recall curve fit tables. The curve fit FRF results are stored in a dedicated register (data register D6 is the default register, though you can change this or have more than one).

Caution

The data registers are cleared when you turn off the analyzer. Save the data register to a file before power-down or it will be lost.

When editing curve fit data, it is easier to remove poles and their associated gain value in a pole-residue synthesis table. Transfer the curve fit table to a synthesis table and convert the table to pole-residue format.

To edit a curve fit table

- 1 Press [**Analys**] [CURVE FIT] [EDIT TABLE].
- 2 To add a value to the synthesis table, press [ADD VALUE] <number><unit>.
- 3 To delete a value, use the knob to move the highlighted bar over the entry you want to delete, press [DELETE VALUE].
If you make a mistake, press [UNDELETE VALUE].
- 4 To change a value, move the highlighted bar over the entry you want to change. Press [CHANGE VALUE] <number><unit>.
- 5 When you are done editing, press [**Rtn**].

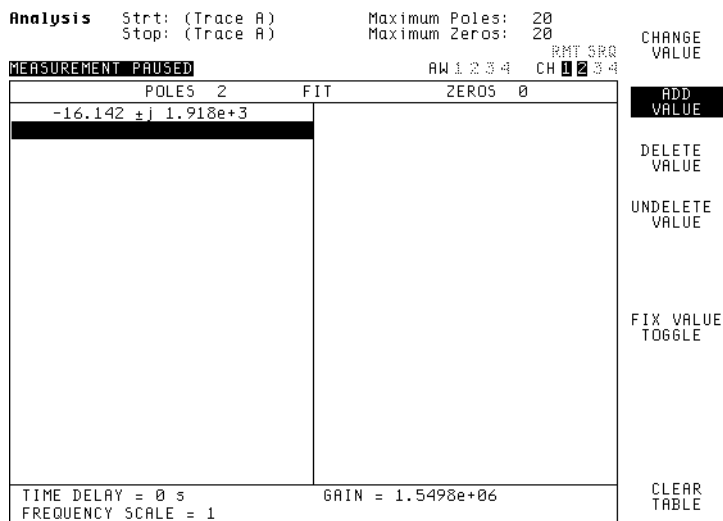

To transfer a curve fit table to a synthesis table

- 1 Press [Analysis] [SYNTHESIS].
- 2 Press [TABLE ON OFF] to highlight ON.
- 3 Press [COPY FROM CURVE FIT].

The curve fit table transfers as a pole-zero format synthesis table. The analyzer's curve fitter does not work with a non-Hermitian frequency-responses because real, measured systems are Hermitian-symmetric.

Any values already in the synthesis table are erased when the curve-fit table is copied.

Analysis Synth Result: D8

START SYNTHESIS

MEASUREMENT PAUSED	AW 1 2 3 4	RMT SRQ	CH 1 2 3 4
POLES 2	SYNTH	ZEROS 0	
-16.142 ±j 1.918e+3			
TIME DELAY = 0 s	GAIN = 1.5498e+06		
FREQUENCY SCALE = 1			

SYNTHESIS REGISTER

EDIT TABLE

COPY FROM CURVE FIT

CONVERT TABLE

SYNTHESIS SETUP

TABLE ON OFF

To compare a frequency response measurement to synthesized results

- 1 Transfer the curve fit table to a synthesis table. See the previous task.
- 2 Press [**Disp Format**] [UPPER/LOWER].
- 3 Press [**Active Trace**] [A]
Press [**Meas Data**] [FREQUENCY RESPONSE].
- 4 Press [**Active Trace**] [B].
- 5 Press [**Analys**] [SYNTHESIS] [START SYNTHESIS].
- 6 Press [**Scale**] [MATCH X SCALE] [TO TRACE A].
- 7 To overlay the results,
press [**Disp Format**] [SINGLE FRNT/BACK].

The analyzer puts the synthesized frequency response on the active trace. To keep the original measurement data on Trace A, put the synthesized data on Trace B.

If you overlay the results in step 3, the vertical scaling for trace B is automatically set to match trace A.

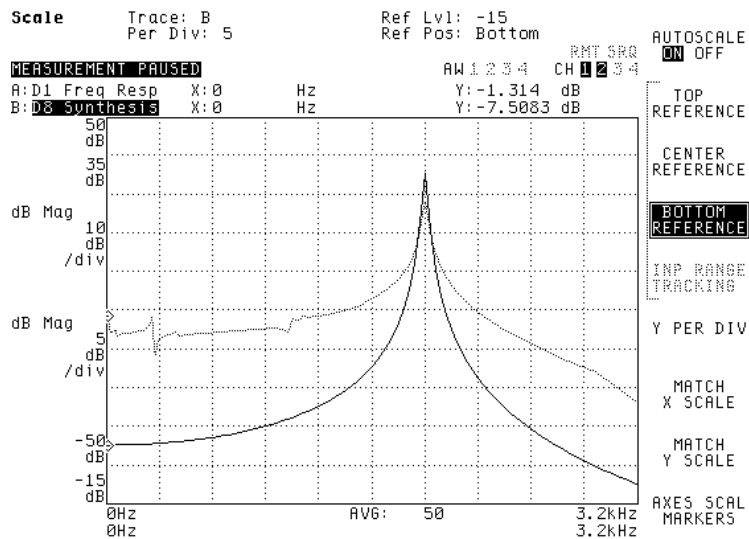

To save a curve fit table

- 1 Specify the default disk. (See “To select the default disk” in chapter 13, “Managing Files and Disks.”)
- 2 Press [Save Recall] [SAVE MORE] [SAVE FIT TABLE].
- 3 Using an external keyboard (or the front-panel alpha keys), type an appropriate filename. The default is FIT1.FIT.
- 4 Press [ENTER].

You can store a curve fit table into the analyzer’s non-volatile RAM (NVRAM), RAM or internal disk. Step 1 specifies where you store the curve fit table. You can also store a table to an external disk via the GPIB. For more information, see *GPIB Programming with the Agilent 35670A*.

SAVE FIT TABLE = FIT3.FIT

MEASUREMENT PAUSED

LIF	FILE NAME	RAM:	SIZE	TYPE	AVAILABLE SPACE:	LAST CHANGED
					60672	
	FIT1.FIT		1792	BDAT	16/01/92	12:56:24 AM
	FIT2.FIT		1792	BDAT	16/01/92	01:00:02 AM

ENTER

INSERT SPACE

DELETE CHARACTER

UPPERCASE

lowercase

MORECHARS +-*/=()

MORECHARS "&#;:,|"

MORECHARS \$<>[]{} \

MORECHARS ~%!'?`_

CLEAR ENTRY

To save a curve fit's frequency response function

- 1 Press [**Active Trace**] [A]
Press [**Meas Data**] [MORE CHOICES] [DATA REGISTER] [D6].
- 2 Specify the default disk. (See "To select the default disk" in chapter 13, "Managing Files and Disks.")
- 3 Press [**Save Recall**] [SAVE DATA] [SAVE TRACE][INTO FILE].
- 4 Using an external keyboard (or the front-panel alpha keys), type an appropriate filename. The default is TRAC1.DAT.
- 5 Press [ENTER].

This task stores a curve fit trace into the analyzer's non-volatile RAM (NVRAM), RAM or internal disk. Step 1 specifies where you store the curve fit trace.

The results of the curve fit are automatically stored in a dedicated data register. The default register is D6. To change the data register, see "To change the curve fit register."

Caution

The data registers are cleared when you turn off the analyzer. Save the data register to a file before power-down or it will be lost.

To recall a curve fit table

- 1 Specify the default disk. (See “To select the default disk” in chapter 13, “Managing Files and Disks.”)
- 2 Press [Save Recall], then press [CATALOG ON OFF] to highlight ON.
- 3 Press [RECALL MORE] [RCL FIT TABLE].
- 4 Using the knob, highlight the filename you want to recall.
- 5 Press [ENTER].

You can recall a curve fit table from the analyzer's non-volatile RAM (NVRAM), RAM or internal disk. Step 1 specifies where the curve fit table is stored. You can also recall a table from an external disk via the GPIB. For more information, see *GPIB Programming with the Agilent 35670A*.

RCL FIT TABLE = FIT1.FIT				ENTER
MEASUREMENT PAUSED				AW 1 2 3 4 CH 1 2 3 4
LIF	RAM:	SIZE	AVAILABLE SPACE: 60672	INSERT SPACE
FILE NAME			LAST CHANGED	DELETE CHARACTER
FIT1.FIT	1792	B DAT	16/01/92 12:56:24 AM	UPPERCASE
FIT2.FIT	1792	B DAT	16/01/92 01:00:02 AM	lowercase
				MORECHARS +-*/=()
				MORECHARS "&#; : , @
				MORECHARS \$ < > [] { } \
				MORECHARS ~ % ' ! ? ` _
				CLEAR ENTRY

Use the knob to scroll through catalog.

To change the curve fit register

- 1 Press [**Analys**] [CURVE FIT] [CURVE FIT REGISTER].
- 2 Press [D1]
or
Press [D2]
or
Press [D3]
or
Press [D4]
or
Press [D5]
or
Press [D6]
or
Press [D7].

The results of the curve fit trace are stored in a dedicated data register. The default register is D6.

If you change the curve fit register, your selection is stored in RAM. If you preset the analyzer, the selection returns to the default data register, D6.

Caution

The data registers are cleared when you turn off the analyzer. Save the contents of a data register to a file before power-down or it will be lost.

Limit Testing

This chapter shows you how to use the analyzer's limit-testing functions. The functions allow you to define a set of limits and then test measurement results against those limits.

To draw a limit

- 1 Activate the trace you want to create a limit for.
- 2 Press [Analys] [LIMIT TEST], then press [DEFINE UPPER LIM] or [DEFINE LOWER LIM].
- 3 Turn the knob to place the limit marker at the beginning of your limit line. (Press [MOVE MKR HORIZONTAL] and [MOVE MKR VERTICAL] to control the knob's effect on the marker.)
- 4 Press [START xxx SEG].
- 5 Turn the knob to place the limit marker at the end of your limit line.
- 6 Press [FINISH xxx SEG].
- 7 Press [Rtn] or some other hardkey to exit the Define Limit menu.

This task, as written, shows you how to create a single-segment limit line. However, you can modify the task to create a multi-segment line. Just repeat steps 5 and 6 several times before completing step 7.

The limit you create is stored in the upper or lower limit register of the active trace—depending on which key you pressed in step 2. You can evaluate a trace against the limit by enabling limit testing, as shown in “To enable limit testing,” later in this chapter.

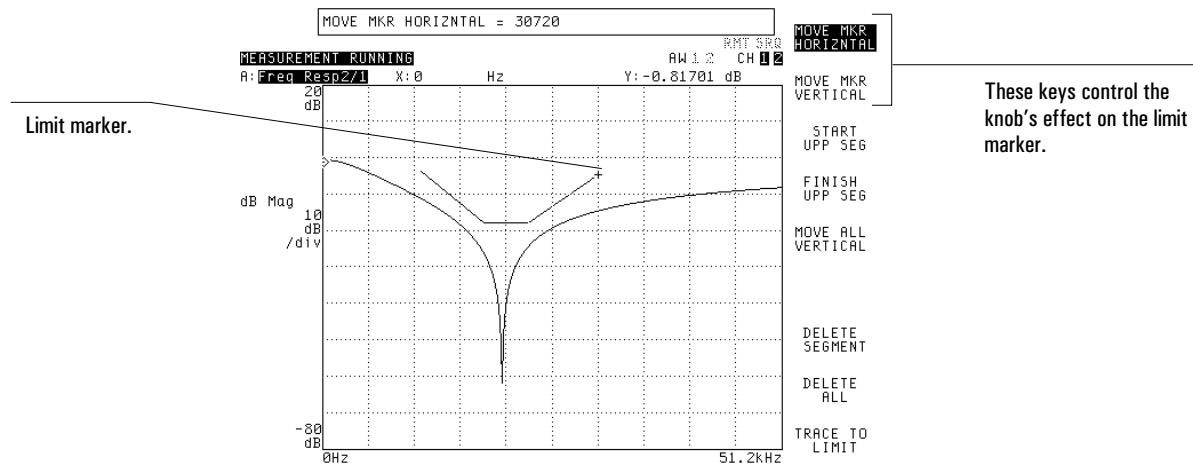

To delete a limit segment

- 1 Activate the trace whose limit segment you want to delete.
- 2 Press [Analys] [LIMIT TEST].
- 3 If you want to delete a segment from the upper limit, press [DEFINE UPPER LIM].
- 4 If you want to delete a segment from the lower limit [DEFINE LOWER LIM].
- 5 Press [MOVE MKR HORIZONTAL], then turn the knob to align the limit marker with the segment you want to delete.
- 6 Press [DELETE SEGMENT].

After you finish drawing a limit, you may sometimes decide that a particular segment should be redrawn. To do this, you can delete the segment as described in this task, and then redraw the segment as described in “To draw a limit.” If you decide that the entire limit should be redrawn, you can press [DELETE ALL] [CONFIRM DELETE] in step 6, and then redraw all the segments.

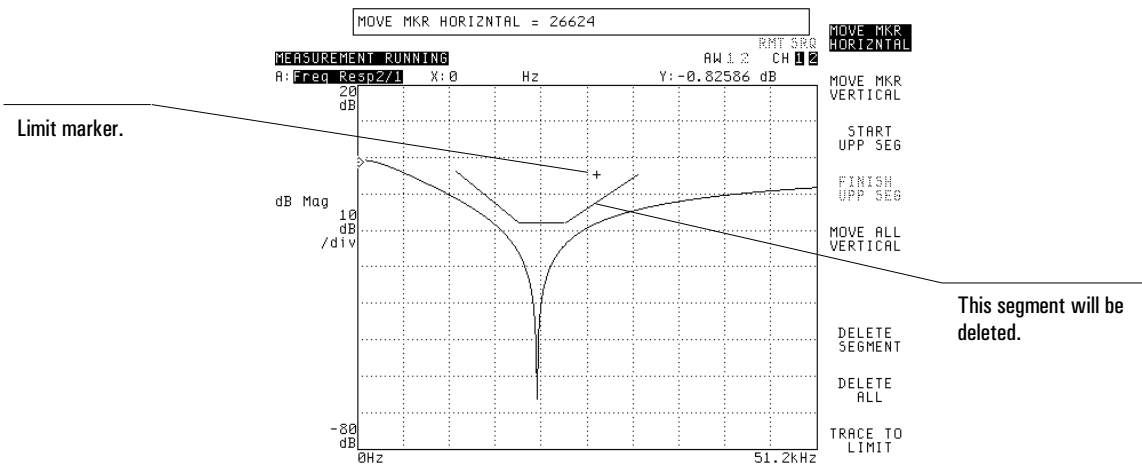

To convert a trace to a limit

- 1 Activate the trace you want to convert to a limit.
- 2 Press **[Analys]** **[LIMIT TEST]**, then press **[DEFINE UPPER LIM]** or **[DEFINE LOWER LIM]**.
- 3 Press **[TRACE TO LIMIT]**.

The analyzer can convert a trace to a limit. This allows you to create a reference trace (by measuring a standard device) and then test the performance of other devices against that trace. The limit you create is stored in the upper or lower limit register of the active trace—depending on which key you pressed in step 2.

When you convert a trace to a limit, you will probably want to shift the new limit vertically to allow for some deviation from the reference trace. Press **[MOVE ALL VERTICAL]** and enter the amount of deviation you can allow. The limit will be shifted by this amount.

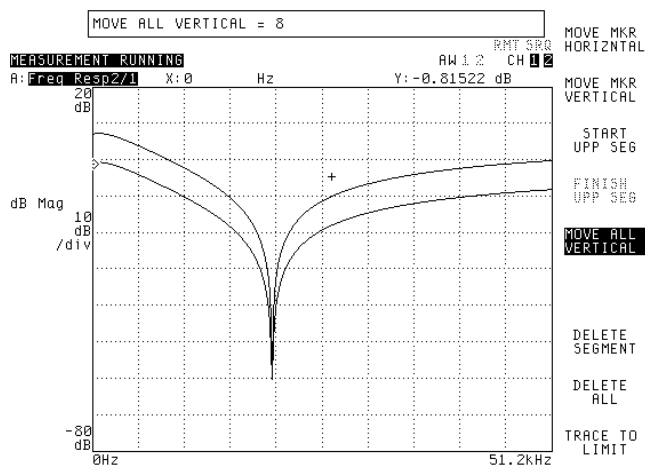

Use **[MOVE ALL VERTICAL]** to move the recalled limit up or down.

To enable limit testing

- 1 Activate the trace you want to test.
- 2 Press [**Analys**] [LIMIT TEST], then press [TEST EVAL ON OFF] to highlight ON.
- 3 If you want the analyzer to display the limits during testing, press [LINES ON OFF] to highlight ON.
- 4 If you want the analyzer to beep when your trace fails the limit test, press [FAIL BEEP ON OFF] to highlight ON.

Limit testing allows the analyzer to evaluate a trace against the contents of an upper and a lower limit register. You can load the registers by drawing limits or by recalling previously defined limits from files (using the Recall Limit softkeys under the [Save/Recall] hardkey).

When limit testing is enabled, the trace is evaluated each time it is updated. If any point on the trace falls above an upper limit or below a lower limit, the trace fails the test. The results of the test are displayed in the lower-left corner of the trace area.

[BEEPER ON OFF], located under the [**System Utility**] hardkey, must also be set to ON if you want the analyzer to beep when your trace fails a limit test.

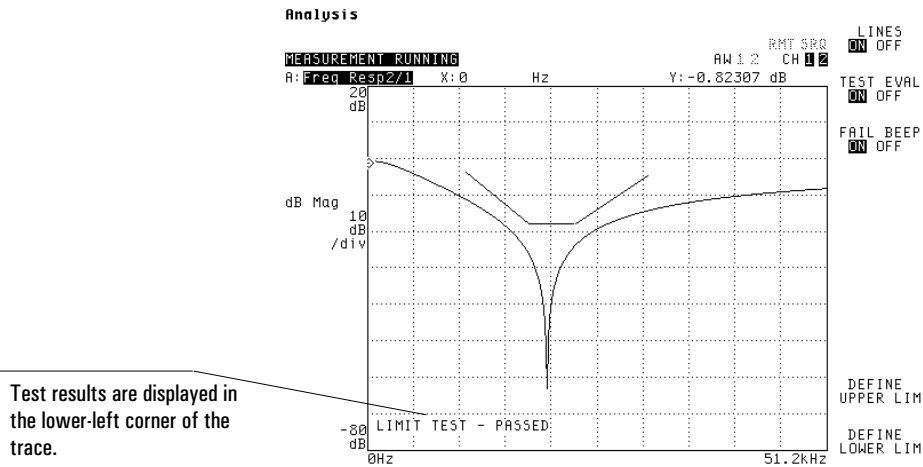

Test results are displayed in the lower-left corner of the trace.

To save a limit

- 1 Activate the trace containing the limit you want to save.
- 2 Press [**Save/Recall**] [SAVE MORE], then press [SAVE UPPER LIM] or [SAVE LOWER LIM].
- 3 Type a file name, then press [ENTER].

After you press [ENTER], the analyzer saves the upper or lower limit in the current directory of the default disk. If more than one trace is active, the limit is saved from the most active trace. (For a definition of the most active trace, see online help for the [**Active Trace**] hardkey.) Once you have saved a limit, you can copy it to any active trace with the [RECALL UPPER LIM] or [RECALL LOWER LIM] softkey—located under [**Save/recall**] [RECALL MORE].

The analyzer has eight limit registers: one upper and one lower limit register for each of the four traces. Each register holds a complete limit. The contents of these registers are not altered when you preset the analyzer, but they *are* lost when you turn off the analyzer. If you create limits that you want to reuse, it's best to save them to a flexible disk so they won't be lost.

Math Operations
and Data Editing

Math Operations and Data Editing

You can use the analyzer's [Analys] menu to set up math operations and edit the contents of the analyzer's data registers.

Math Operations

Using constants and functions, you can perform a variety of operations on current (or stored) traces. You can use math to modify the results of a measurement—for example, to compensate for a fixed gain (or loss) in a system- or device-under-test. You can also use a math operation to modify a trace—for example, to invert a trace. And you can use math to add, subtract, multiply, or divide two traces or operate on a trace with a constant or a complex constant.

Special Considerations

It is not difficult to use math operations, but there are some things you should know before building your own math functions:

- A math function can contain the current input data, a stored trace, or a constant.
- Math functions are specified by entering the definition with operands and operators in standard algebraic notation.
- To exit any math menu without affecting any function or constant definitions, simply press any hardkey.
- Math operations are stored in volatile RAM. They remain after a preset, but are lost if you cycle power.

Editing Data Registers

Data editing allows you to change the trace stored in a data register. You can define a line segment by specifying the start X and stop X positions, then entering the start Y and stop Y values. The analyzer connects the two points with a straight line. You can insert as many lines as you need.

You must modify start Y or stop Y. If you do not change either Y-value, the analyzer does not change the data between the two points. You can then move start X and stop X to define a new band.

You can edit a data register to do the following:

- Modify a trace to remove an objectionable component. For example, you can “zero out” part of a trace by defining a line segment from point to point. You can do this for any type of trace.
- Modify a waveform to use as an arbitrary source. For example, you can remove the lower half of a sine wave (in the time-domain) by drawing a line segment between the negative crossover points of the sine wave.
- Specify a weighting function for a curve fit operation. See “To specify a weighting function,” in chapter 16, “Curve Fit.”
- Specify a weighting filter for a trace. The analyzer has three filters, A-weight, B-weight and C-weight that are available as math operations. You can modify one of these filters to create your own filter.

Using Logarithmic Values with Math Operations

The analyzer performs math operations in linear units, not logarithmic units. This is true regardless of the trace coordinate.

All math operations occur *before* the analyzer converts measurement data to the display units.

This is important to keep in mind when you need to add (or subtract) units with logarithmic values—for example, if you need to compensate for a gain or loss in your measurement system.

Suppose you want to add 3 dB to your measurement results. You can not build a math function that simply adds 3 dB since math operation are done with linear units. Instead, you must take a trace and multiply it by the antilog of the offset (in dB) that you want. This converts

the 3 dB to linear units—and you can express this offset as 10 to the $x/20$, where x is the dB offset. To convert power spectra units, you express the offset as 10 to the $x/10$, where x is the dB offset.

So, if you want to add 3 dB in linear units, you must multiply a trace by 1.414. If you want to subtract 3 dB in linear units, you can divide the trace by 1.414 (or conversely, you can multiply the trace by 0.707). If you want to add 3 dB in power spectra units, you must multiply by 1.995. If you want to subtract 3 dB in power spectra units, you must divide by 1.995.

To define a constant

- 1 Press [**Analys**] [DEFINE CONSTANT (K1-K5)].
- 2 Press [DEFINE K1].
or
Press [DEFINE K2].
or
Press [DEFINE K3].
or
Press [DEFINE K4].
or
Press [DEFINE K5].
- 3 Enter <number>.
or
Enter <number> [+j] <number>.
or
Enter <number> [+j] [+/-] <number>.
- 4 Press [ENTER].

The constant registers contain default values. See the illustration below.

Constants can be defined as complex numbers. In step 3, the first number is the real part and the second number is the imaginary part. Use the [+/-] key to enter a -j.

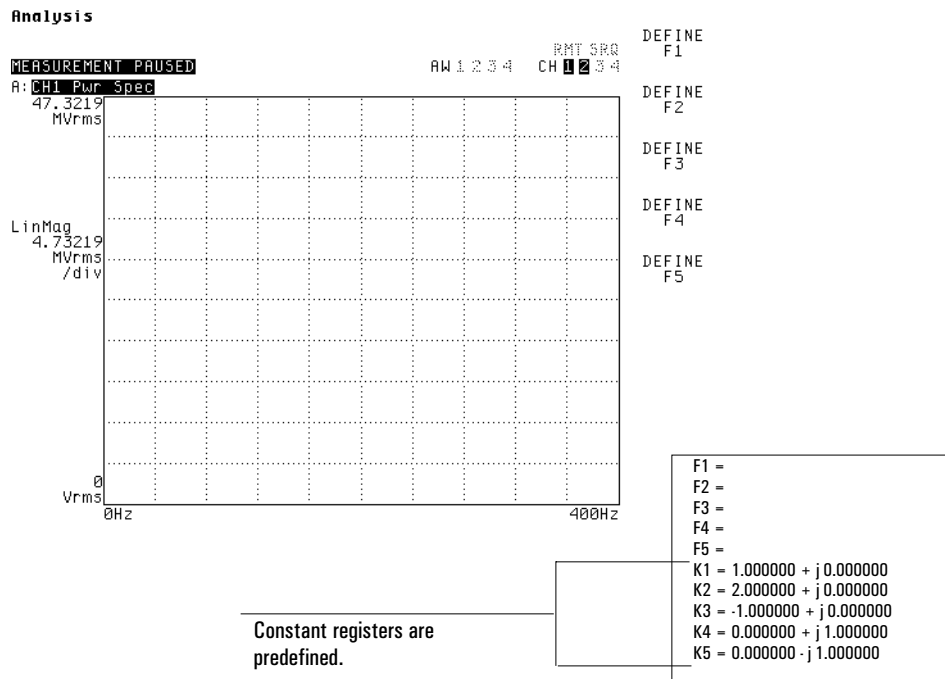

To specify an operand within an operation

1 Select the function register.

Press [**Analys**] [DEFINE FUNCTION (F1-F5)].

Press [DEFINE F1].

or

Press [DEFINE F2].

or

Press [DEFINE F3].

or

Press [DEFINE F4].

or

Press [DEFINE F5].

2 Specify the operation.

Press [OPERATION] and then press the appropriate operation softkey.

3 Specify the data.

Press [MEAS DATA] and then press the appropriate measurement softkey.

or

Press [DATA REGISTER (D1-D8)] and then press the appropriate [DATA REGISTER] softkey.

or

Press [CONSTANT (K1-K5)] and then press the appropriate [CONSTANT] softkey.

or

Press [FUNCTION (F1-F5)] and then press the appropriate [FUNCTION] softkey.

An operand can contain:

- the current input data
- a stored trace (the contents of a data register)
- the contents of a function register
- a constant (the contents of a constant register)

Agilent 35670A Operations

The Agilent 35670A provides numerous operations and operands to build a math function.

Operations include:

AWEIGHT	Applies an A-weight filter
BWEIGHT	Applies a B-weight filter
CWEIGHT	Applies C-weight filter
CONJ	Complex Conjugate
DIFF	Differentiate
/JOMEGA	divide by $j\omega$
EXP	Exponential
FFT	Fast Fourier Transform
INVERSE FFT	Inverse Fast Fourier Transform
INTEG	Integrate
IMAG	Imaginary Part
LN	Natural Logarithm
MAG	Magnitude
PSD	Power Spectral Density
REAL	Real Part
SQRT	Square Root
*JOMEGA	multiply by $j\omega$

Measurement data depends on instrument mode.

In **FFT** instrument mode, data selections include:

PWR SPEC	Power Spectrum
LIN SPEC	Linear Spectrum
TIME	Time Data
FREQ RESP	Frequency Response
COHERENCE	COH
CROS SPEC	Cross Spectrum
WINDOWED TIME	Windowed Time Data

In **octave** analysis instrument mode (Option 1D1), data selections include:

PWR SPEC	Power Spectrum
-----------------	----------------

In **order** analysis instrument mode (Option 1D0), data selections include:

PWR SPEC	Power Spectrum
TIME	Resampled Time
COMP PWR	Composite Power
ORDER TRK	Order Track
RPM Profile	

In **swept sine** instrument mode (Option 1D2), data selections include:

LIN SPEC	Linear Spectrum
TIME	Time Data
FREQ RESP	Frequency Response
CROS SPEC	Cross Spectrum
NORM VAR	Normalized Variance

In **correlation** instrument mode, data selections include:

TIME	Time Data
AUTO CORR	Autocorrelation
CROS CORR	Cross Correlation
WINDOWED TIME	Windowed Time Data

In **histogram/time** instrument mode, data selections include:

HISTOGRAM	
PDF	Probability Density Function
CDF	Cumulative Density Function
TIME	Unfiltered Time

To define a function

- 1 Press [**Preset**] [DO PRESET]
Press [**Analys**].
- 2 Select the function register.
- 3 Specify the first operand.
- 4 Specify the operator.
Press [+].
or
Press [-].
or
Press [*].
or
Press [/].
- 5 Specify the second operand.
- 6 Complete the function.
Repeat Steps 3, 4, and 5 until you have completed building the function.
Press [ENTER].

Define a math function by entering the operands and operators in standard algebraic notation. The operations apply to the active trace. The calculation is performed immediately after the operation is selected...

Use the beginning and closing parenthesis in the operator menu to specify the order in which operation should be performed. The analyzer automatically inserts closing parenthesis, “)”.

A log magnitude or dB magnitude trace is strictly a function of the display. The data is stored in linear format, so to subtract log magnitude (or dB magnitude) traces, you must divide (*not* subtract).

To view the results of a math operation

- 1 Specify the active trace. See “To select the active trace” in chapter 8.
- 2 Press [**Meas Data**] [MORE CHOICES][MATH FUNCTIONF2 55P255J0].
- 3 Press [F1].
or
Press [F2].
or
Press [F3].
or
Press [F4].
or
Press [F5].
- 4 Press [**Scale**] [AUTOSCALE ON OFF] to highlight ON.

A math function must be defined before it can be displayed. If you display a math function that cannot be executed, the analyzer displays the grid with no data.

Functions are stored in volatile RAM. They remain after a preset, but are lost if you cycle power. Save a math function to a file before power-down or it will be lost.

To compute cepstrum

- 1 Press [**Preset**] [DO PRESET].
- 2 Select the active trace.
- 3 Select the function register.
Press [**Analys**] [DEFINE FUNCTION (F1-F5)] [DEFINE F1].
- 4 Specify the operations.
Press [OPERATION] [FFT()].
Press [OPERATION] [MORE][LN()].
Press [MEAS DATA].
Press [CHANNEL 1 2](or [CHANNEL 1 2 3 4]) to highlight 1, then press [POWER SPEC1].
- 5 Complete the function.
Press [ENTER].

A cepstrum is a spectrum of a logarithmic (amplitude) spectrum. It can be used for detecting any periodic structure in the spectrum—harmonics, sidebands, or the effects of echoes.

This task illustrates the use of one of the analyzer's math operations. The cepstrum is calculated by taking the \log_e of the power spectrum and then computing the FFT.

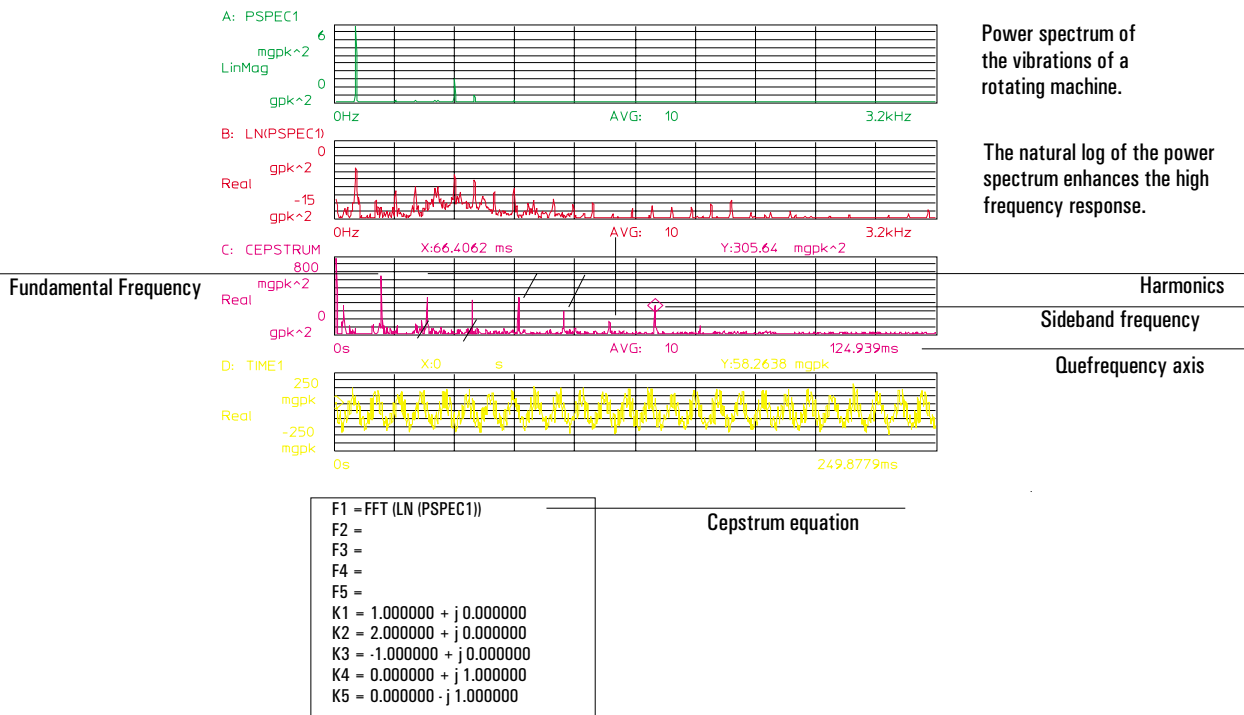

To compute a Hilbert transform

- 1 Cycle power. Connect the signal source to Channel 1.
- 2 Press **[Analys]** [DEFINE FUNCTION] [DEFINE F1].
- 3 Press [OPERATION] [INVERSE FFT].
- 4 Press [CONSTANT (K1-K5)] [CONSTANT K5] [*].
- 5 Press [OPERATION] [FFT] [MEAS DATA] [TIME CHANNEL 1].
- 6 Press [ENTER].
- 7 Press **[Meas Data]** [MORE CHOICES] [MATH FUNCTION] [F1].
Press **[Trace Coord]** [MORE CHOICES] [REAL PART].

The Hilbert transform of a time domain signal is another time domain signal which does not change the magnitude of the signal but shifts the phase -90° for positive frequencies and $+90^\circ$ for negative frequencies. To calculate the Hilbert transform of a time signal, you:

- take the FFT of the time signal (step 5)
- change the phase of each of the frequency components by ± 90 (depending on whether they are positive or negative frequencies) (step 4)
- take the inverse FFT of the result (step 3)

Cycling power presets the constant register, [CONSTANT K5], to the default value, $0.000000 - j 1.000000$.

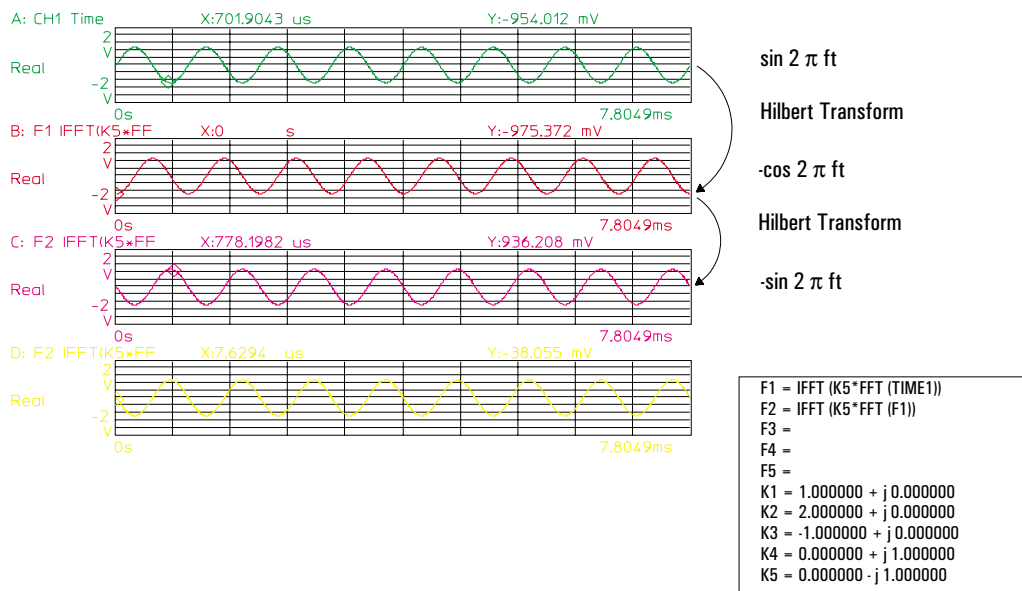

To calculate the envelope of a function

- 1 Press [**Analys**] [DEFINE FUNCTION].
Define the Hilbert transform in [FUNCTION F1].
- 2 Press [DEFINE F2].
Press [MEAS DATA] [TIME CHANNEL 1] [*].
Press [CONSTANT (K1-K5)] [CONSTANT K1] [+].
- 3 Press [(] [FUNCTION (F1-F5)] [FUNCTION F1] [*] [CONSTANT (K1-K5)] [CONSTANT K4].
Press [ENTER].
- 4 Press [**Meas Data**] [MORE CHOICES] [MATH FUNCTION] [F2].
- 5 Press [**Trace Coord**] [LINEAR MAGNITUDE].

The Hilbert transform is called a poor man's demodulation because you can use it to study the envelope of a modulating signal. In addition, you can determine system delays by identifying peak positions of the magnitude.

The envelope function is the linear magnitude of the analytic signal. The linear magnitude trace coordinate is the square root of the sum of the squares of the real and imaginary components. The analytic signal is the sum of

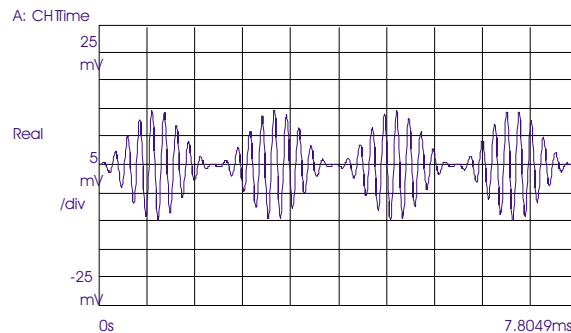

```
F1 = IFFT (K5*FFT (TIME1)
F2 = TIME1 * K1 + (F1 * K4)
F3 =
F4 =
F5 =
K1 = 1.000000 + j 0.000000
K2 =
K3 =
K4 = 0.000000 + j 1.000000
K5 = 0.000000 - j 1.000000
```

Trace A shows the modulating signal.

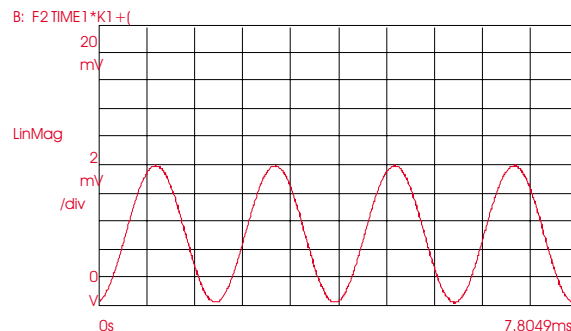

Trace B shows the envelope of the signal in Trace A.

Math Operations and Data Editing

Cycle power. Set up the analyzer and the device-under-test for a frequency response measurement with RMS averaging.

Press **[Analyz]** [DEFINE FUNCTION (F1-F5)] [DEFINE F1].

Press **[MEAS DATA]** [COHERENCE 2/1].

Press **[/]** [()].

Press **[CONSTANT (K1-K5)]** [CONSTANT K1].

Press **[+]** [()].

Press **[CONSTANT (K1-K5)]** [CONSTANT K3]

Press **[*]**.

Press **[MEAS DATA]** [COHERENCE 2/1].

Press **[ENTER]**.

Press **[Meas Data]** [MORE CHOICES] [MATH FUNCTION] [F1].

Press **[Trace Coord]** [MORE CHOICES] [REAL PART].

Press **[Scale]** [AUTOSCALE ON OFF] to highlight ON.

The signal-to-noise (S/N) ratio versus frequency is calculated from the coherence function. The signal power spectrum is G_{yy} and true noise is G_{nn} .

$$\frac{S(f)}{N(f)} = \frac{G_{yy}(f)}{G_{nn}(f)} = \frac{y^2(f)}{1 - y^2(f)}$$

The coherence value $\gamma^2(f)$ has a range of 0.0 to +1.0 which corresponds to a signal-to-noise range of 0 to infinity.

The S/N ratio is computed by dividing the coherence data by the product of multiplying the coherence, a real number, by minus one and then adding one.

This task utilizes the predefined constant registers. [CONSTANT K1] contains a positive one (+1); [CONSTANT K3] contains a negative one (-1).

MeasData A: F1 B: FreqResponse
[FFT] C: Coherence D: F3

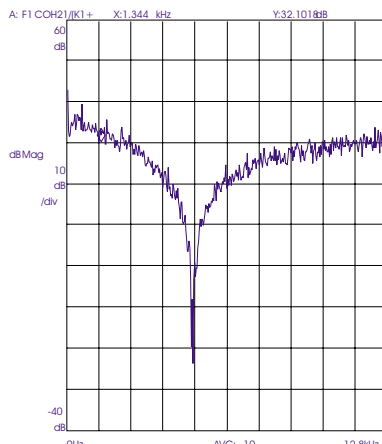

F1 reads as _____

```
F1 = COH21/(K1 + (K3 * COH21))
F2 =
F3 =
F4 =
F5 =
K1 = 1.000000 + j 0.000000
K2 = 2.000000 + j 0.000000
K3 = -1.000000 + j 0.000000
K4 = 0.000000 + j 1.000000
K5 = 0.000000 - j 1.000000
```

To compute group delay

Cycle power. Set up the device-under-test (DUT) with the analyzer for a frequency response measurement.

Press [**Analys**] [DEFINE CONSTANT] [DEFINE K1].

Using the numeric keypad, enter the value of π , 3.14159.

Press [ENTER] [**Rtn**].

Press [DEFINE FUNCTION] [DEFINE F1].

Press [OPERATION] [MORE] [DIFF()].

Press [OPERATION] [IMAG()].

Press [OPERATION] [MORE] [LN()].

Press [MEAS DATA] [FREQ RESP 2/1].

Press [)], three times.

Press [*].

Press [CONSTANT (K1-K5)] [CONSTANT K3].

Press [/] [()].

Press [CONSTANT (K1-K5)] [CONSTANT K2].

Press [*].

Press [CONSTANT (K1-K5)] [CONSTANT K1].

Press [ENTER].

Press [**Meas Data**] [MORE CHOICES] [MATH FUNCTION] [F1].

Press [**Trace Coord**] [MORE CHOICES] [REAL PART].

Press [**Scale**] [AUTOSCALE ON OFF] to highlight ON.

Group delay is the negative derivative of the phase of the frequency response.

$$\text{GROUP DELAY} = \text{DIFF}(\text{PHASE}(\text{FRES21})) * \left(-\frac{1}{2\pi} \right)$$

This task computes the equivalent group delay at minimum aperture. It utilizes the predefined constant registers, [CONSTANT K2] = 2.0 and [CONSTANT K3] = -1.0. [CONSTANT K1] is defined as π . You could define [CONSTANT K1] as -0.1592 and avoid using constants K2 and K3.

Because phase is not available as a math operation, we use the imaginary part of the natural logarithm of the frequency response, $\text{IMAG}(\text{LN}(\text{FRES21}))$. The result, which is unwrapped phase, is in radians and may be offset by an integer multiple of 2π .

```
F1 = DIFF (IMAG (LN(FRES21))) * K3/(K2 * K1)
F2 =
F3 =
F4 =
F5 =
K1 = 3.141592
K2 = 2.000000 + j 0.000000
K3 = -1.000000 + j 0.000000
K4 = 0.000000 + j 1.000000
K5 = 0.000000 - j 1.000000
```

Using constant registers

$$F1 = (\text{IMAG}(\text{LN}(\text{FRE21}))) * \left(-\frac{1}{2\pi} \right)$$

To modify a waveform

- 1 Display the waveform (trace) you wish to edit as the active trace.
- 2 Store the waveform to a data register.
Press [**Pause-Cont**].
Press [**Save/Recall**] [SAVE DATA] [SAVE TRACE] [INTO D1].
- 3 Press [**Analys**] [DATA EDIT] [EDIT D1].
- 4 Move the cursor to the first point on the trace you want to modify.
Press [START X] [**Marker Value**].
Move the cursor to the last point of the segment you want to modify.
Press [STOP X] [**Marker Value**].
or
Press [START X] <number> <unit>.
Press [STOP X] <number> <unit>.
- 5 Press [MODIFY START Y] <number> <unit>.
Press [MODIFY STOP Y] <number> <unit>.
- 6 Press [**Scale**] [AUTOSCALE ON OFF] to highlight ON.
The trace is saved to set the time X-axis scaling of the data traces.

Caution

The data registers are cleared when you turn off the analyzer. Save the data register to a file before power-down or it will be lost.

Scale Trace: A Ref Lvl: 400m
Per Div: 200m Ref Pos: Cntr

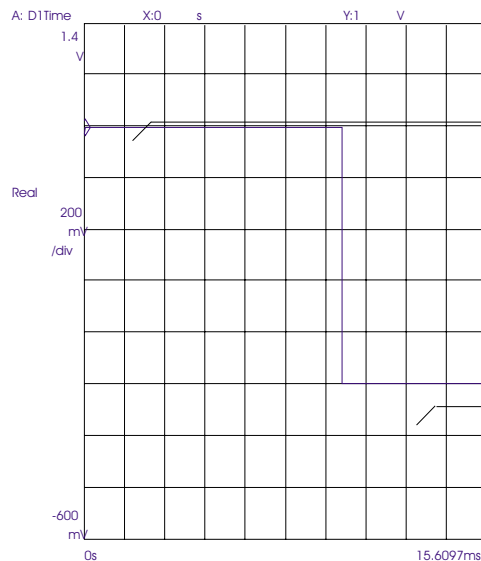

Repeat steps 4 and 5 using
different X and Y values.

Index

A

A-weight
filter **3-6 - 3-7**
overall band **3-8**
ac coupling **4-2**
acceleration units **11-7**
active trace **8-2**
address
external disk **13-2**
plotter **14-4**
printer **14-4**
amplitude
demod (using the
Hilbert transform) **18-11**
units **11-5 - 11-8**
annotation
plot or print title **14-7**
trace title **9-5**
X- and Y-axis values **9-3**
aperture, group delay **4-14**
arbitrary source
measuring step response **5-9**
overview **6-2**
profiled chirp signal **6-9**
ramp signal **6-6**
repeat feature **6-2**
scaling **6-2**
step signal **6-4**
triggering **6-2**
arming
rpm-stepped **1-12, 1-16**
time-stepped **1-13, 1-17**
autoranging **Part I-8, Part I-10**
autoscaling **Part I-19, 10-2**
averaging
fast **Part I-15, 4-9**
in octave mode **3-7**

averaging (continued)
overview **Part I-15**
repeat **4-9**
selecting type **4-3**
specifying number **4-3**
turning on and off **4-3**
types **Part I-16**
using preview **2-14**
with waterfall displays **4-9**
AW indicator **3-7**
axes scale markers **10-5, 10-7**

B

baseline suppression in waterfall **9-8**
BASIC
See Instrument BASIC
baud rate **14-3**
bias errors, in curve fit **16-14**
bits per character **14-3**

C

calibrating
microphone **3-4 - 3-5**
transducer **1-4 - 1-5**
capture
See time capture
Centronics connector **14-2**
cepstrum, computing **18-9**
channels
preset state **Part I-3**
selecting in menus **4-3**
selecting reference **4-11**
character bits **14-3**
chirp **4-11**
closed loop response **5-18**
coherence **4-11**
condenser microphone **3-3**
constant, defining **18-4**

- control systems
 - closed loop response **5-18**
 - delay time **5-11**
 - gain margin **5-16**
 - measuring a step response **5-8**
 - measuring Y/S **5-18**
 - Nyquist diagram **5-17**
 - open loop response **5-14**
 - overshoot **5-11**
 - performance parameters **5-11**
 - phase margin **5-16**
 - profiled chirp source signal **6-9**
 - ramp source signal **6-6**
 - rise time **5-11**
 - settling time **5-11**
 - step response **5-9**
 - step source signal **6-4**
 - T/(1-T) **5-20**
 - transfer function **5-20**
- coordinate system **11-2**
- copying files **13-15**
- coupling, input **4-2**
- current directory **13-5**
- curve fit
 - bias errors **16-14**
 - changing data register **16-43**
 - copying to a synthesis table **15-34, 16-38**
 - curve fit region **16-17**
 - delay **16-24**
 - errors **16-11**
 - fixed poles and zeros **16-24**
 - frequency scale **16-27**
 - importance of coherence **16-22**
 - noise and errors **16-15**
 - obtaining good results **16-11**
 - operating modes **16-5**
 - overview of procedures **16-27**
 - performing **16-33**
 - recalling a table **16-42**
 - saving a table **16-40**
 - set up **16-30, 16-34**
 - stimuli **16-11**
 - storing a trace **16-41**
 - synthesized results **16-39**
 - systems with nonlinearities or distortion **16-11**
 - weighting function **16-23**
- D**
- data
 - recalling from disk **13-12**
 - saving to disk **13-9**
- data registers
 - displaying **8-6**
 - editing **18-2**
 - for curve fit tables **16-43**
 - for synthesis tables **15-35**
 - modify a waveform **6-8, 18-14**
 - modify weighting function **16-32**
- dBm units **11-8**
- dc coupling **4-2**
- default directory **13-5**
- default disk **13-3**
- delay
 - group **4-14**
 - trigger **Part I-14**
- delay time **5-11**
- deleting
 - directories **13-14**
 - files **13-13**
- demodulation, using Hilbert transform **18-10 - 18-11**
- directory
 - creating new **13-6**
 - deleting **13-14**
 - selecting current **13-5**
- disk
 - formatting **13-4**
 - selecting default **13-3**
 - setting up external **13-2**
- displacement units **11-7**
- display
 - plotting contents **14-5**
 - printing contents **14-6**
- display format **Part I-17, 9-2**
- distortion
 - harmonic **4-7**
 - phase **4-14**
- driving point measurement
 - imaginary part **2-13**
 - preview **2-14**
 - real part **2-13**
 - set-up **2-10**
 - unwrapped phase **2-12**

E

- electret microphone 3-3
- engineering units
 - See transducer units
- error (NaN marker value) 15-13
- EU defined 11-6
- external disk
 - selecting as default 13-3
 - setting up 13-2
- external monitor 9-6

F

- FFT analysis
 - frequency resolution with Part I-6
 - with time capture 7-11
- file
 - copying 13-15
 - deleting 13-13
 - general recalling 13-12
 - general saving 13-9
 - plotter output 14-5
 - printer output 14-6
 - recalling program 13-11
 - recalling time-capture buffer 7-7
 - recalling trace 13-10
 - renaming 13-16
 - saving autostate 13-9
 - saving limit lines 17-6
 - saving program 13-8
 - saving time-capture buffer 7-6
 - saving trace 13-7
 - saving waterfall 13-7
- filter, A-weight 3-6 - 3-7
- flow control 14-3
- formatting
 - disks 13-4
 - displayed traces 9-2
- frequency
 - maximum FFT spans 4-2
 - resolution 4-5
 - scaling in synthesis 15-23
 - span in synthesis 15-25
 - units 11-3
- frequency response
 - distortion due to overload 2-11
 - synthesizing 15-26
 - using FFT analysis 4-10
 - using swept sine analysis 4-12
- front/back display format 9-2

function

- defining registers 18-7
- displaying 8-7
- See also math operations

G

- gain factor, synthesis 15-23
- gain margin 5-16
- GPIB
 - disk address 13-2
 - plotter address 14-4
 - printer address 14-4
- grid, trace 9-4
- group delay
 - computing 18-13
 - displaying 4-14

H

- hammer test, setup 2-10
- handshaking 14-3
- harmonic distortion 4-7
- help
 - See online help
- Hilbert transform 18-10
- hypertext links, help 12-3

I

- IEC 651 3-9
- imaginary component, viewing 2-13
- impulse characteristics (octave) 3-9
- index, help 12-4
- input
 - autoranging Part I-10
 - autoranging in order mode 1-11
 - fixed input range Part I-10
 - measuring from 7-12
 - overload conditions Part I-9
 - range Part I-8
- Instrument BASIC
 - recalling a program 13-11
 - saving a program 13-8
- instrument state, saving 13-9
- internal disk
 - formatting 13-4
 - selecting as default 13-3

L

Laurent term **15-13**
limit line
 converting from trace **17-4**
 copying **17-6**
 deleting **17-3**
 displaying **17-5**
 drawing **17-2**
 moving vertically **17-4**
 saving **17-6**
limit marker **17-2**
limit testing **17-5**
linear sweep **4-13**
links, help **12-3**
logarithmic sweep **4-13**

M

magnitude units **11-5, 11-8**
map, order **1-12 - 1-13**
marker
 axes scale **10-5, 10-7**
 entering value in a softkey **4-4**
 moving limit **17-2**
 NaN **15-13**
 time capture **7-9, 7-12**
 turning on main **4-4**
marker functions
 gain margin **5-16**
 harmonic **4-7**
 phase margin **5-16**
 sideband **4-8**
marker readout **9-4**
 absolute versus relative **4-4**
 frequency resolution **4-5**
math operations
 calculating the envelope **18-11**
 computing cepstrum **18-9**
 computing group delay **18-13**
 computing phase **18-13**
 computing S/N ratio **18-12**
 defining a constant **18-4**
 defining a function **18-7**
 defining operands **18-5**
 displaying results **8-7**
 Hilbert transform **18-10**
 modifying a waveform **6-8**
 overview **18-2**
 special considerations **18-2**
 T/(1-T) **5-20**

math operations (continued)
 viewing results **18-8**
 weighting function **6-9**
measurement data
 availability **8-3**
 displaying from multiple channels **8-5**
 displaying from one channel **8-3 - 8-4**
memory, allocating for time capture **7-4**
mic connector **3-2**
microphone
 calibrating **3-4 - 3-5**
 connecting **3-3**
 electret caution **3-3**
 specifying output unit **3-4**
microphone adapter (Opt. UK4)
 connecting **3-2**
 pin descriptions **3-3**
Mkr Value hardkey **4-4**
monitor, external **9-6**
most active trace **8-2**

N

NaN **15-13**
narrowband measurement **4-4**
noise measurement **4-6**
nonvolatile RAM disk **13-3**
Nyquist diagram **5-17**

O

octave analysis **3-1**
 See also SPL
octave overall band
 A-weighted **3-8**
 general-purpose **3-8**
online help
 general **12-2**
 index **12-4**
 links to related topics **12-3**
 printing topics **12-5**
 quitting **12-6**
open loop response **5-14**
orbit diagram **1-20 - 1-21**
order analysis with time capture **7-2 - 7-3, 7-10 - 7-11**
order map **1-12 - 1-13**
order spectrum, measuring **1-10 - 1-11**
order track, measuring **1-14 - 1-18**

overall band
 A-weighted octave **3-8**
 displaying **9-4**
 octave **3-8**
overloads **2-11**
overshoot **5-11**

P

parallel port **14-2**
parity **14-3**
Pascal (unit) **3-4**
path **13-5**
percent overshoot **5-11**
performing a curve fit **16-33**
periodic chirp **4-11**
phase
 computing with math **18-13**
 measuring distortion **4-14**
 measuring in order mode **1-18**
 units **11-4**
phase margin **5-16**
plotter
 HP-IB setup **14-4**
 modifying plotting speed **14-9**
 parallel setup **14-2**
 pen assignment **14-8**
 serial setup **14-3**
 setting P1 and P2 **14-10**
plotting
 position on page **14-10**
 screen contents **14-5**
 to file **14-5**
 with annotation **14-7**
 with time stamp **14-7**
power spectral density **4-6**
preview averaging **2-14**
printer
 HP-IB setup **14-4**
 parallel setup **14-2**
 serial setup **14-3**
printing
 help topics **12-5**
 screen contents **14-6**
 to file **14-6**
 with annotation **14-7**
 with time stamp **14-7**
profiled chirp signal, creating **6-9**

program
 recalling **13-11**
 saving **13-8**
PSD **4-6**

Q

quad display format **9-2**

R

ramp signal, creating **6-6**
range
 input **Part I-8**
 order mode restrictions **1-11**
 time capture restrictions **7-2**
real component, viewing **2-13**
recalling
 a curve fit table **16-42**
 a synthesis table **15-33**
 general **13-12**
 programs **13-11**
 time-capture buffer **7-7**
 trace **13-10**
reference channel **4-11**
renaming files **13-16**
rise time **5-11**
rpm profile, displaying **1-19**
rpm-stepped arming **1-12, 1-16**
RS-232-C connector **14-3**
runup/rundown measurement **1-12, 1-16**

S

saving
 a curve fit table **16-40**
 a curve fit trace **16-41**
 a synthesis table **15-31**
 a synthesis trace **15-32**
 autostate **13-9**
 general **13-9**
 limit lines **17-6**
 programs **13-8**
 time-capture buffer **7-6**
 trace **13-7**
 waterfall **13-7**
scale markers **10-5, 10-7**
scaling
 automatic Y-axis **10-2**
 axes markers **5-17**
 input range tracking **Part I-19**

scaling (continued)
 manual Y-axis **10-3 - 10-4**
 matching scale of two traces **10-6, 10-8**
 resetting X-axis scale **10-7**
 resetting Y-axis scale **10-5**
 with axes scale markers **10-5, 10-7**
 screen
 adjusting brightness **9-6**
 enabling external **9-6**
 turning on and off **9-6**
 screen saver **9-6**
 serial port **14-3**
 setting up a curve fit **16-30, 16-34**
 settling time **5-11**
 sideband power **4-8**
 signal-to-noise ratio
 computing **18-12**
 skewing a waterfall **9-8**
 slice through a waterfall **9-11**
 sound pressure level
 See SPL
 source
 See also arbitrary source
 creating profiled chirp signal **6-8**
 creating ramp signal **6-6**
 creating step signal **6-4**
 impedance **Part I-11**
 periodic chirp **4-11**
 span
 maximum in FFT mode **4-2**
 time capture restrictions **7-11**
 SPL
 displaying overall bands **9-4**
 general **3-6**
 overall **3-8**
 state, saving **13-9**
 step response **5-8 - 5-9**
 step signal, creating **6-4**
 stop bits **14-3**
 structures, driving point
 measurement **2-10**
 sweep, linear vs log **4-13**
 swept sine analysis **4-12**
 synthesis
 analyzer configuration **15-25**
 building pole-residue equations **15-10**
 calculation of **15-3**
 changing data register **15-35**
 changing table format **15-16 - 15-17**
 clearing a table **15-24**
 converting tables **15-13**
 synthesis (continued)
 copying from a
 curve fit table **15-34, 16-38**
 creating a table **15-18, 15-22**
 data formats **15-4**
 delay **15-20**
 displaying a table **15-15**
 frequency response **15-26**
 frequency scale **15-21**
 frequency scaling **15-23**
 frequency span **15-25**
 gain factor **15-19, 15-23**
 Laurent terms **15-13**
 NaN marker value **15-13**
 non-Hermitian entries **15-7, 15-13**
 numeric range **15-29**
 optional parameters **15-23**
 partial fraction format **15-16**
 pole-residue data **15-6**
 pole-residue example **15-10**
 pole-residue format **15-16**
 pole-zero data **15-4**
 pole-zero example **15-5**
 pole-zero format **15-15**
 polynomial data **15-11**
 polynomial format **15-17**
 recalling a table **15-33**
 reconstructing complex
 conjugate pole-pairs **15-8**
 reconstructing simple poles **15-7**
 saving a table **15-31**
 start frequency **15-25**
 stop frequency **15-25**
 storing a trace **15-32**
 time delay **15-20, 15-23**
 X-axis spacing **15-25, 15-28**
 synthesis table
 changing format **15-16**
 clearing **15-24**
 creating **15-18, 15-22**
 displaying **15-15**
 editing **15-30**
 recalling **15-33**
 saving **15-31**

T

tachometer
 characterizing signal **1-8 - 1-9**
 readout **9-3**
 using as phase reference **1-18**

- THD **4-7**
 - time capture
 - aborting data collection **7-5**
 - allocating memory **7-4**
 - defining an analysis region **7-9**
 - examining the capture buffer **7-8**
 - filling the capture buffer **7-2 - 7-3, 7-5**
 - measurement marker **7-12**
 - measuring from the capture buffer **7-10 - 7-12**
 - ranging restrictions **7-2**
 - recalling the buffer from disk **7-7**
 - restrictions on changing instrument modes **7-11**
 - saving the buffer to disk **7-6**
 - span restrictions **7-11**
 - time record restrictions **7-11**
 - time delay
 - curve fit **16-24**
 - synthesis **15-23**
 - time record, time capture restrictions **7-11**
 - time stamp **14-7**
 - time units **11-3**
 - time-stepped arming **1-13, 1-17**
 - title
 - plot or print **14-7**
 - trace **9-5**
 - total harmonic distortion **4-7**
 - trace
 - active **8-2**
 - arranging on the screen **9-2**
 - coordinate system **11-2**
 - displaying grids **9-4**
 - height in waterfall **9-8**
 - matching scale of another trace **10-6, 10-8**
 - most active **8-2**
 - recalling **13-10**
 - saving **13-7**
 - scaling automatically **10-2**
 - scaling manually **10-3 - 10-4**
 - scaling with axes scale markers **10-5, 10-7**
 - title **9-5**
 - track, order **1-14 - 1-18**
 - transducer
 - calibrating **1-4 - 1-5**
 - connecting **1-2**
 - converting units **11-7**
 - entering sensitivity **11-6**
 - selecting units **3-4, 11-6**
 - transducer units
 - converting **11-7**
 - selecting **11-6**
 - transducer units (continued)
 - selecting **11-6**
 - See also* units
 - transfer function **5-20**
 - triggering
 - delay **Part I-14**
 - process **Part I-13**
- ## U
- units
 - acceleration **11-7**
 - amplitude **11-5 - 11-8**
 - displacement **11-7**
 - frequency **11-3**
 - phase **11-4**
 - time **11-3**
 - See also* transducer units
 - velocity **11-7**
 - upper/lower display format **9-2**
- ## V
- velocity units **11-7**
 - vibration
 - measuring with FFT mode **1-6 - 1-7**
 - measuring with order mode **1-10 - 1-11, 1-14 - 1-15**
 - volatile RAM disk **13-3**
- ## W
- waterfall buffer
 - displaying **9-9**
 - displaying a slice through **9-11**
 - displaying a trace from **9-10**
 - saving **13-7**
 - scrolling through **9-9**
 - specifying size **9-7, 9-9**
 - waterfall display
 - baseline suppression **9-8**
 - clearing **9-9**
 - differences while
 - measuring and paused **9-9**
 - effects of autoscaling **Part I-19**
 - enabling **9-7**
 - skewing **9-8**
 - trace height **9-8**
 - with averaging **4-9**
 - Z-axis scaling **9-7, 9-9**

- waterfall markers
 - enabling **9-9**
 - slice select **9-11**
 - trace select **9-10**
- waterfall steps **9-7, 9-9**
- waveform, modifying **18-14**
- weighting
 - A-weight filter **3-6 - 3-7**
 - exponential time (impulse) **3-9**
 - in curve fit **16-23**
 - See also* window
- window
 - defined **Part I-12**
 - to improve accuracy **2-7**

X

- X-axis
 - marker readout **4-5**
 - matching scale of two traces **10-8**
 - resetting scale **10-7**
 - scaling with axes scale markers **10-7**
 - spacing for synthesis **15-28**
- xdc
 - See* transducer

Y

- Y-axis
 - marker readout **4-5**
 - matching scale of two traces **10-6**
 - resetting scale **10-5**
 - scaling automatically **10-2**
 - scaling manually **10-3 - 10-4**
 - scaling with axes scale markers **10-5**

Z

- Z-axis scaling **9-7, 9-9**
- zoom and time capture **7-11**

Guide to Agilent 35670A Documentation

If you are thinking about...	And you want to...	Then read...
Unpacking and installing the Agilent 35670A	Install the Agilent 35670A Dynamic Signal Analyzer Do operation verification or performance verification tests	<i>Agilent 35670A Installation and Verification Guide</i> <i>Agilent 35670A Installation and Verification Guide</i>
Getting started	Make your first measurements with your new analyzer Review measurement basics Learn what each key does	<i>Agilent 35670A Quick Start Guide</i> <i>Agilent 35670A Operator's Guide</i> Use the analyzer's [Help] key
Making measurements	Learn how to make typical measurements with the Agilent 35670A Understand each of the analyzer's instrument modes	<i>Agilent 35670A Operator's Guide</i> <i>Agilent 35670A Operator's Guide</i>
Creating automated measurements (Instrument BASIC is Option 1C2)	Learn the Instrument BASIC interface Record keystrokes for a particular measurement Program with Instrument BASIC	<i>Using Instrument BASIC with the Agilent 35670A</i> <i>Agilent 35670A Quick Start Guide</i> <i>Agilent BASIC User's Handbook</i>
Remote operation	Learn about the GPIB Learn how to program with GPIB Find specific GPIB commands	GPIB Programmer's Guide <i>GPIB Programming with the Agilent 35670A</i> <i>Agilent 35670A GPIB Commands: Quick Reference</i>
Using analyzer data with a PC application	-Display or plot analyzer data on or from a Personal Computer -Transfer analyzer data to a PC software application format - Transfer data from a PC software application format to the analyzer (for example, to load data into a data register)	<i>Standard Data Format Utilities: User's Guide</i>
Servicing the analyzer	Adjust, troubleshoot, or repair the analyzer	<i>Agilent 35670A Service Guide</i>

Need Assistance?

If you need assistance, contact your nearest Agilent Technologies Sales and Service Office listed in the Agilent Catalog. You can also find a list of local service representatives on the Web at:

<http://www.agilent.com/find/assist> or contact your nearest regional office listed below.

If you are contacting Agilent Technologies about a problem with your Agilent 35670 Dynamic Signal Analyzer, please provide the following information:

- Model number: Agilent 35670A
- Serial number:
- Options:
- Date the problem was first encountered:
- Circumstances in which the problem was encountered:
- Can you reproduce the problem?
- What effect does this problem have on you?

You may find the serial number and options from the front panel of your analyzer by executing the following:

Press [**System Utility**], [more], [serial number].

Press [**System Utility**], [options setup].

If you do not have access to the Internet, one of these centers can direct you to your nearest representative:

United States	Test and Measurement Call Center (800) 452-4844 (Toll free in US)
Canada	(905) 206-4725
Europe	(31 20) 547 9900
Japan	Measurement Assistance Center (81) 426 56 7832 (81) 426 56 7840 (FAX)
Latin America	(305) 267 4245 (305) 267 4288 (FAX)
Australia/New Zealand	1 800 629 485 (Australia) 0800 738 378 (New Zealand)
Asia-Pacific	(852) 2599 7777 (FAX) (852) 2506 9285
