

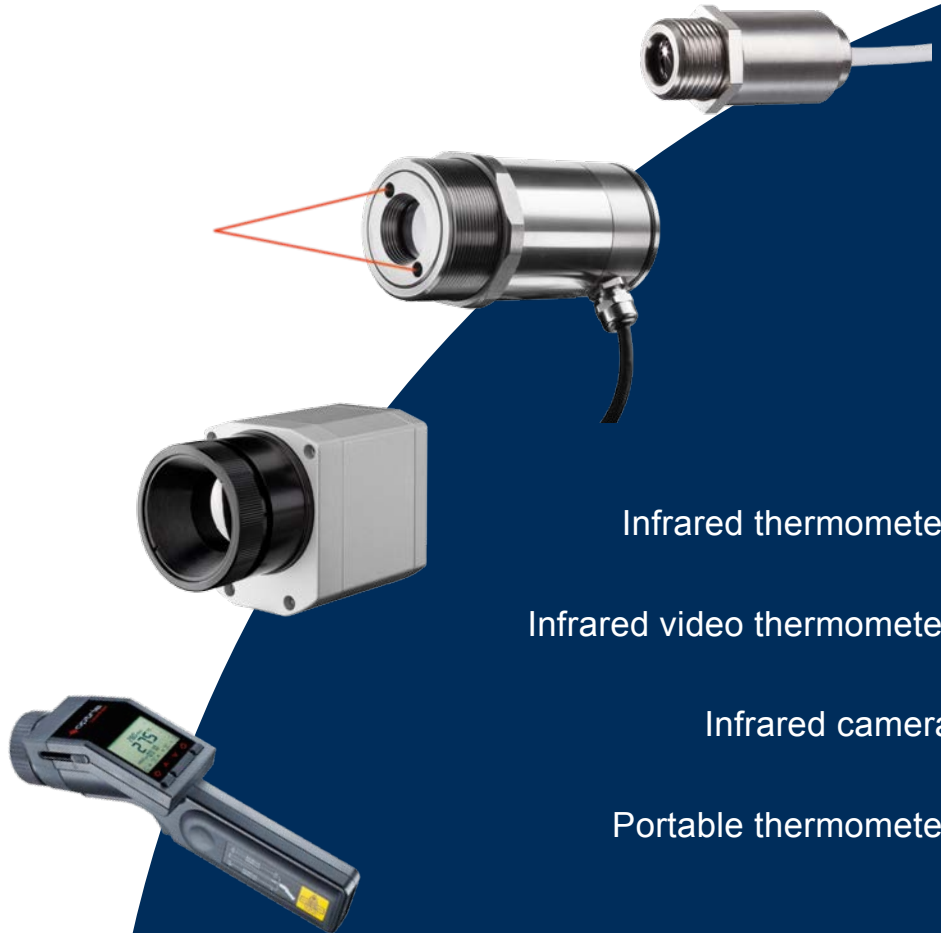

site:[www.open17.com](http://www.open17.com)



Infrared thermometers

Infrared video thermometers

Infrared cameras

Portable thermometers

## PRODUCT OVERVIEW

Non-contact Temperature Measurement

Made in Germany

innovative infrared technology

# THE ADEQUATE MEASUREMENT DEVICE

## Spot measurement or thermal image?

First of all, it is important to define the measurement task and to decide on one of these two measures:



A **selective measuring infrared thermometer** should be used if you know where the critical point or the area to be measured is positioned within your application. The size of the measuring object is important to define which lens is necessary. It is therefore possible to monitor the accurate temperature and optimize processes – if necessary – before quality problems arise.

**Pyrometer configurator:**  
[www.optris.com/pyrometer-selector](http://www.optris.com/pyrometer-selector)

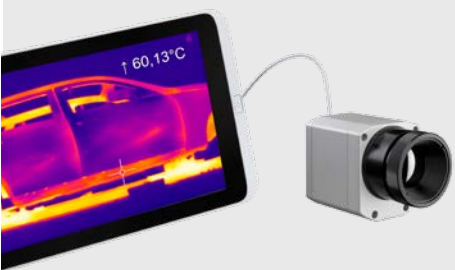

**Infrared cameras** should be used in cases where more than one critical area exists or the area cannot be clearly defined. Critical areas can be localized by the camera through the demonstration of thermal images. The areas can then be permanently monitored by one or multiple fixed infrared thermometers.

## Which object surface?

The condition of the object surface defines the measurement device and wavelength to be used for the application. The **emissivity  $\epsilon$**  occupies a central position. The choice of the right device is of great importance especially for metals, where the emissivity depends on the temperature and wave length.

We offer appropriate measurement devices for most applications throughout a wide product range. The following explanation helps to find the right **wavelength** for your application:

- 7,9  $\mu\text{m}$  for plastic foils and glass surfaces (Type of device: P7)
- 8 – 14  $\mu\text{m}$  for non-metal surfaces (Type of device: LT)
- 7.9; 4.64; 4.24; 3.9  $\mu\text{m}$  for special applications (Type of device: F6; F2; MT)
- 5.0  $\mu\text{m}$  for glass surfaces (Type of device: G5)
- 2.3; 1.6; 1.0; 0.5  $\mu\text{m}$  mainly for liquid metals and metal surfaces (Type of device: 05M; 1M; 2M; 3M)

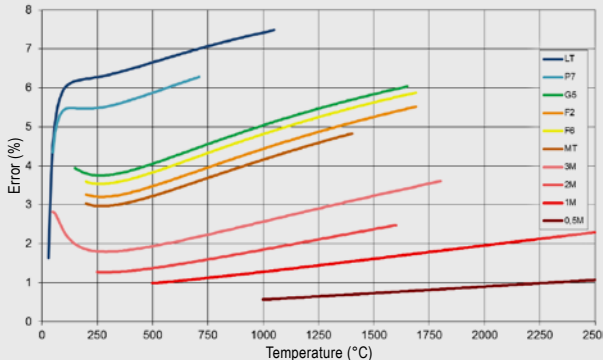

Short wavelengths reduce measurement errors on surfaces with low, unknown or changing emissivity. This occurs mostly with metals. The diagram above shows the measurement errors across different wavelengths if the emissivity is wrongly adjusted by only 10 percent.

## Which temperature range?

The temperature is another factor to decide on. The range should cover all relevant temperatures of the

application. The measurement range of the devices is between **-50 °C and 3000 °C**.

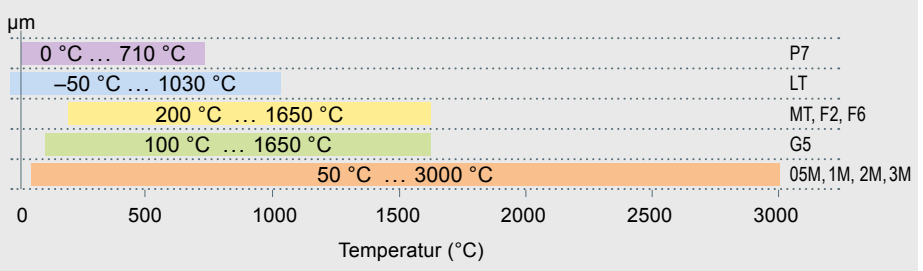

Display of temperature over wavelength for the devices of the high performance series

### Which process velocity?

To achieve accurate temperature measurement it is important to know how fast measuring objects are moving in front of the sensor or how fast they change temperature.

Our fastest infrared thermometer captures changes within **1 ms**.

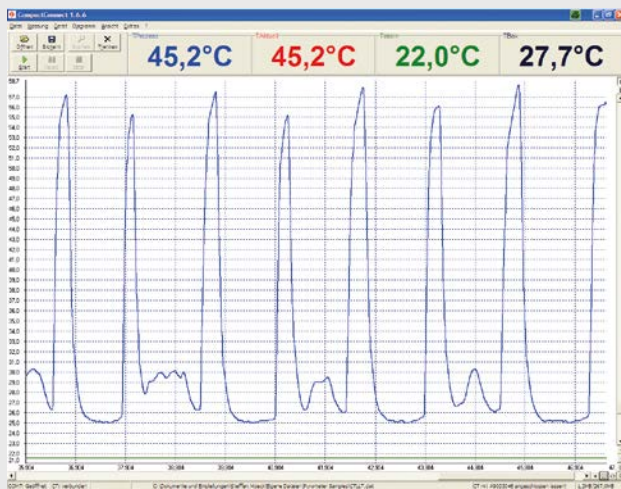

Display of fast temperature changes over a period of time.

### Integration of sensors?

Our temperature sensors can be installed as part of the process with **mounting brackets** or **flanges**.

Depending on the device, we offer different analog and digital interfaces for **data evaluation** such as triggering, alerting or saving of data.

#### Analog Interfaces:

0 – 20 mA, 4 – 20 mA, 0 – 5 V, 0 – 10 V,  
Thermocouple (type J, type K)

#### Digital Interfaces:

USB, RS232, RS485, Relay, Profibus DP, CAN Bus, Ethernet

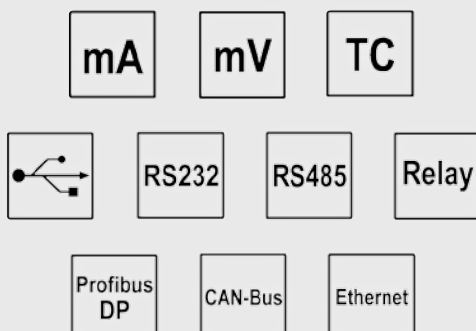

### Object size/distance to sensor?

The optical resolution of the checking device is chosen with regard to the size of the object under test and the distance between the object under test and the sensor.

As with the emissivity, the choice of the wrong lens will lead to extensive temperature differences ( $\Delta T$ ). The spot size of the checking device ( $d_{\text{meas}}$ ) is not allowed to be bigger than the size of the checked object ( $d_{\text{real}}$ ). Otherwise the following applies:

$$\Delta T_{\text{real}} (d_{\text{real}} / d_{\text{meas}})^2 = \Delta T_{\text{meas}} \quad (\text{für } d_{\text{real}} \leq d_{\text{meas}})$$

Example: Measurement of an SMD component

$$80 \text{ }^\circ\text{C} (5 \text{ mm} / 10 \text{ mm})^2 = 20 \text{ }^\circ\text{C}$$

$$80 \text{ }^\circ\text{C} (5 \text{ mm} / 5 \text{ mm})^2 = 80 \text{ }^\circ\text{C}$$

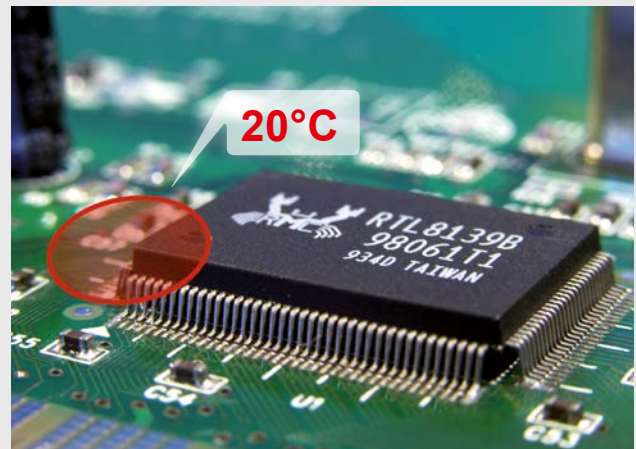

Spot size chosen too big which results in a measurement error

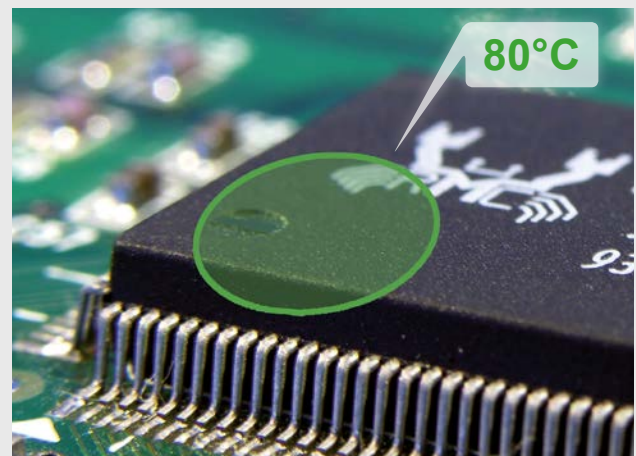

Appropriate spot size and correct temperature definition

# COMPACT SERIES

Small, compact infrared thermometers, ideal for use in cramped and hot surroundings



Base Model	CS	CSmicro	CSmicro 2W	CSmicro 2W	CSmicro 2W
Type	LT	LT02 / LT15 / 3M	LT15/LT15H/LT22H	hs LT	2M
Classification / special features	Single-piece sensor with smart LED display (self diagnostics, aiming support, alarm, temperature code)	Single-piece sensor with electronics in cable and smart LED display (aiming support, alarm, temperature code)	Single-piece two-wire sensor with electronics in cable; smart LED display (aiming support, alarm, temperature code)	Single-piece two-wire sensor with electronics in cable with high thermal sensitivity; smart LED display; temperature code	Single-piece two-wire sensor with electronics in applications; smart LED display; temperature code
Detector	Thermopile	Thermopile/3M: Ext. InGaAs	Thermopile	Thermopile	InGaAs
Sensing head exchangeable	–	–	–	–	–
Head cable shortening	■	■ (behind electronics)	■ (behind electronics)	■ (behind electronics)	■ (behind electronics)
Thread (sensing head)	M12x1	M12x1	M12x1	M18x1	M12x1
Spectral range	8–14 μm	8–14 μm / 3M: 2.3 μm	8–14 μm	8–14 μm	1.6 μm
Temperature ranges	–40 °C... 1030 °C	–40 °C... 1030 °C 3ML: 50 °C... 350 °C 3MH: 100 °C... 600 °C	–40 °C... 1030 °C	–20 °C... 150 °C	2ML: 250 °C... 800 °C 2MH: 385 °C... 1600 °C
Temperature resolution	0.1 K	0.1 K	0.1 K	0.025 K [ $>20\text{ °C}$ ]	0.1 K
Optical resolution	15:1	LT02: 2:1 / LT15: 15:1 / 3ML: 22:1 / 3MH: 33:1	LT15: 15:1/LT15H: 15:1 / LT22H: 22:1	15:1	2ML: 40:1 2MH: 75:1
Option: CF lens	■	■	■	■	■
Smallest spot (CF optics/add. CF lens)	0.8 mm @ 10 mm	LT02: 2.5 mm @ 23 mm LT15: 0.8 mm @ 10 mm 3M: 1.5 mm @ 10 mm	LT15: 0.8 mm @ 10 mm LT15H: 0.8 mm @ 10 mm LT22H: 0.6 mm @ 10 mm	0.8 mm @ 10 mm	2MH: 1.5 mm @ 110 mm 2ML: 2.7 mm @ 110 mm
Smallest spot (SF optics)	7 mm	7 mm	7 mm	7 mm	7 mm
Sighting	LED aiming	LED aiming	LED aiming	LED aiming	LED aiming
Response time (90 %)	25 ms	30 ms	LT: 30 ms/LTH: 150 ms	150 ms	10 ms
Accuracy	$\pm 1.5\text{ °C}$ or $\pm 1.5\%$	$\pm 1.5\text{ °C}$ or $\pm 1.5\%$	$\pm 1.5\text{ °C}$ or $\pm 1\%$	$\pm 1\text{ °C}$ or $\pm 1\%$	$\pm(0.3\% T_{\text{meas}} + 2\text{ °C})$
Outputs analog: 0–20 mA / 4–20 mA / 0–5 V / 0–10 V / t/c (K/J)	- / - / ■ / ■ / ■	- / - / ■ / ■ / -	- / ■ / - / - / -	- / ■ / - / - / -	- / ■ / - / - / -
Second analog output	–	–	–	–	–
Interfaces: USB / RS232 / RS485 / Profibus / Ethernet	■ / - / - / - / -	■ / - / - / - / -	■ / - / - / - / -	■ / - / - / - / -	■ / - / - / - / -
Signal processing: Peak / Valley / AVG / Advanced hold	■ / ■ / ■ / ■	■ / ■ / ■ / ■	■ / ■ / ■ / ■	■ / ■ / ■ / ■	■ / ■ / ■ / ■
T <sub>Amb</sub> Head min.	–20 °C	–20 °C	–20 °C	–20 °C	–20 °C
T <sub>Amb</sub> Head max.	80 °C	LT02/LT15: 120 °C 3M: 85 °C	LT15: 120 °C LT15H/LT22H: 180 °C	75 °C	125 °C
T <sub>Amb</sub> Electronics max.	80 °C	80 °C	75 °C	75 °C	75 °C
Functional inputs/ number	■ / 1	■ / 1	- / -	- / -	- / -
External emissivity adjustment	■ (via V <sub>cc</sub> adjust)	■ (via V <sub>cc</sub> adjust)	–	–	–
External background temperature control	■	■	–	–	–
Trigger input for reset of hold functions	■	■	–	–	–
Digital I/O pins/ number	–	–	–	–	–
Simultaneous analog and digital output	–	–	■	■	■
Alarm output as an alternative to analog output	■	■	■	■	■
Additional alarm output/ switching output	■	■	■	■	■
Scope of supply	5–30 VDC	5–30 VDC	5–30 VDC	5–30 VDC	5–30 VDC
Standard cable length	1 m	1 m	1 m	4 m	1 m
Cable length options	3 / 8 / 15 m	Options up to 9 m	Options up to 9 m	–	Options up to 9 m

Spot size calculator:  
[www.optris.com/spot-size-calculator](http://www.optris.com/spot-size-calculator)



CT	CTfast	CThot	CT	CT	CT	CT
LT02 / LT15 / LT22	LT15F / LT25F	LT02H / LT10H	1M / 2M	3M	G5	P7
Two-piece sensor with separate electronic box incl. programming keys and display	Two-piece sensor with fast response time and separate electronic box incl. programming keys and display	Two-piece sensor for hot surroundings with separate electronic box incl. programming keys and display	Two-piece sensor for high temp. meas. of metal with separate electronic box incl. progr. keys and display	Two-piece sensor for low temp. meas. of metal with separate electronic box incl. progr. keys and display	Two-piece sensor for temp. meas. of glass with separate electronic box incl. progr. keys and display	Two-piece sensor for temp. meas. on plastic foils and glass with separate electronic box incl. progr. keys and display
Thermopile	Thermopile	Thermopile	1M: Si / 2M: InGaAs	Extended InGaAs	Thermopile	Thermopile
■	-	-	■ [+CTlaser 1M/2M]	■ [+CTlaser 3M]	■	-
■ [-0.1 K/m]	■ [max. 3 m]	■ [-0.1 K/m]	■ [max. 3 m]	■	■ [-0.1 K/m]	-
M12x1	M12x1	M18x1	M12x1	M12x1	M12x1	M18x1
8-14 µm	8-14 µm	8-14 µm	1M: 1.0 µm / 2M: 1.6 µm	2.3 µm	5.0 µm	7.9 µm
LT02: -50 °C ... 600 °C LT15: -50 °C ... 600 °C LT22: -50 °C ... 975 °C	-50 °C ... 975 °C	-40 °C ... 975 °C	1ML: 485 °C ... 1050 °C 1MH: 650 °C ... 1800 °C 1MH1: 800 °C ... 2200 °C 2ML: 250 °C ... 800 °C 2MH: 385 °C ... 1600 °C 2MH1: 490 °C ... 2000 °C	L: 50 °C ... 400 °C H: 100 °C ... 600 °C H1: 150 °C ... 1000 °C H2: 200 °C ... 1500 °C H3: 250 °C ... 1800 °C	L: 100 °C ... 1200 °C H: 250 °C ... 1650 °C	0 °C ... 710 °C
0.1 K	LT15F: 0.2 K LT25F: 0.4 K	0.25 K	0.1 K	0.1 K	L: 0.1 K H: 0.2 K	0.5 K
LT02: 2:1 / LT15: 15:1 / LT22: 22:1	LT15F: 15:1 LT25F: 25:1	LT02H: 2:1 LT10H: 10:1	L: 40:1 H: 75:1	L: 22:1 / H: 33:1 / H1-H3: 75:1	L: 10:1 H: 20:1	10:1
■	■	■	■	■	-	-
LT02: 2.5 mm @ 23 mm LT15: 0.8 mm @ 10 mm LT22: 0.6 mm @ 10 mm	0.6 mm @ 10 mm	LT02H: 2.5 mm @ 23 mm LT10H: 1.2 mm @ 10 mm	1.5 mm @ 110 mm	3.4 mm @ 110 mm	-	1.2 mm @ 10 mm
7 mm	7 mm	7 mm	7 mm	7 mm	7 mm	7 mm
-	-	-	-	-	-	-
150 ms	LT15F: 9 ms / LT25F: 6 ms	100 ms	1 ms	1 ms	L: 120 ms / H: 80 ms	150 ms
±1 °C or ±1 %	±2 °C or ±1 %	±1.5 °C or ±1 %	±(0.3 % T <sub>meas</sub> + 2 °C)	±(0.3 % T <sub>meas</sub> + 2 °C)	±2 °C or ±1 %	±1.5 °C or ±1 %
■ / ■ / ■ / ■ / ■	■ / ■ / ■ / ■ / ■	■ / ■ / ■ / ■ / ■	■ / ■ / ■ / ■ / ■	■ / ■ / ■ / ■ / ■	■ / ■ / ■ / ■ / ■	■ / ■ / ■ / ■ / ■
■	■	■	-	-	■	■
■ / ■ / ■ / ■ / ■	■ / ■ / ■ / ■ / ■	■ / ■ / ■ / ■ / ■	■ / ■ / ■ / ■ / ■	■ / ■ / ■ / ■ / ■	■ / ■ / ■ / ■ / ■	■ / ■ / ■ / ■ / ■
■ / ■ / ■ / ■	■ / ■ / ■ / ■	■ / ■ / ■ / ■	■ / ■ / ■ / ■	■ / ■ / ■ / ■	■ / ■ / ■ / ■	■ / ■ / ■ / ■
-20 °C	-20 °C	-20 °C	-20 °C	-20 °C	-20 °C	-20 °C
LT02: 130 °C LT15/LT22: 180 °C	120 °C	250 °C	1M: 100 °C 2M: 125 °C	85 °C	85 °C	85 °C
85 °C	85 °C	85 °C	85 °C	85 °C	85 °C	85 °C
■ / 3	■ / 3	■ / 3	■ / 3	■ / 3	■ / 3	■ / 3
■	■	■	■	■	■	■
■	■	■	■	■	■	■
■	■	■	■	■	■	■
-	-	-	-	-	-	-
■	■	■	■	■	■	■
■	■	■	■	■	■	■
■	■	■	■	■	■	■
8-36 VDC	8-36 VDC	8-36 VDC	8-36 VDC	8-36 VDC	8-36 VDC	8-36 VDC
1 m	1 m	3 m	3 m	3 m	3 m	3 m
3 / 8 / 15 m	3 / 8 / 15 m	8 / 15 m	8 / 15 m	-	8 / 15 m	8 / 15 m

# HIGH PERFORMANCE SERIES

Infrared thermometers with highest optical resolution and double laser

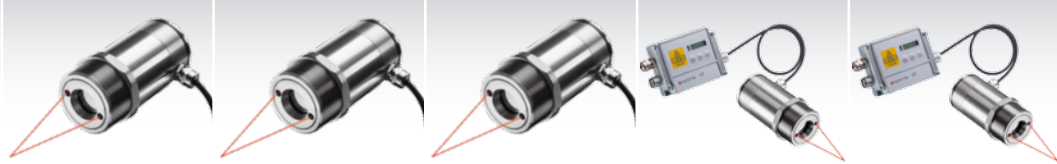

Base Model	CSlaser	CSlaser	CSlaser	CTlaser	CTlaser
Type	LT / hs LT	2M	G5HF	LT / LTF	05M
Classification / special features	Single-piece two-wire sensor with electronics in sensing head	Single-piece two-wire sensor with electronics in sensing head for measurement of metal	Single-piece two-wire infrared thermometer for temperature measurement of glass	Two-piece sensor with separate electronic box with fast response time, incl. programming keys and display	Two-piece sensor with separate electronic box for high temp. measurement of liquid metal, incl. programming keys and display
Detector	Thermopile	InGaAs	Thermopile	Thermopile	Si
Sensing head exchangeable	–	–	–	■	■
Head cable shortening	■	■	■	■ [max. 6 m]	■ [max. 6 m]
Thread (sensing head)	M48x1.5	M48x1.5	M48x1.5	M48x1.5	M48x1.5
Spectral range	8–14 µm	1.6 µm	5.0 µm	8–14 µm	0.525 µm
Temperature ranges	LT: –30 °C ... 1000 °C hs LT: –20 °C ... 150 °C	L: 250 °C ... 800 °C H: 385 °C ... 1600 °C	200 ... 1450 °C	–50 °C ... 975 °C	1000 °C ... 2000 °C
Temperature resolution	LT: 0.1 K / hs LT: 0.025 K	0.1 K	0.1 K	LT: 0.1 K / LTF: 0.5 K	0.2 K
Optical resolution	50:1	300:1	45:1	LT: 75:1 LTF: 50:1	150:1
Option: CF lens	–	–	–	–	–
Smallest spot (CF optics/add. CF lens)	1.4 mm @ 70 mm	0.5 mm @ 150 mm	1.6 mm @ 70 mm	LT: 0.9 mm @ 70 mm LTF: 1.4 mm @ 70 mm	–
Smallest spot (SF optics)	24 mm @ 1200 mm	3.7 mm @ 1100 mm	27 mm @ 1200 mm	LT: 16 mm @ 1200 mm LTF: 24 mm @ 1200 mm	7.3 mm @ 1100 mm
Sighting	Double laser	Double laser	Double laser	Double laser	Double laser
Response time (90 %)	150 ms	10 ms	30 ms	LT: 120 ms / LTF: 9 ms	1 ms
Accuracy	±1 °C or ±1 %	±(0.3 % T <sub>meas</sub> +2 °C)	±1% or ±1 °C	LT: ±1 °C or ±1 % LTF: ±1.5 °C or ±1.5 %	±(0.3 % T <sub>meas</sub> +2 °C)
Outputs analog: 0–20 mA / 4–20 mA / 0–5 V / 0–10 V / t/c (K/J)	– / ■ / – / – / –	– / ■ / – / – / –	– / ■ / – / – / –	■ / ■ / ■ / ■ / ■	■ / ■ / ■ / ■ / ■
Second analog output	–	–	–	■	–
Interfaces: USB / RS232 / RS485 / Profibus / Ethernet	■ / – / – / – / –	■ / – / – / – / –	■ / – / – / – / –	■ / ■ / ■ / ■ / ■	■ / ■ / ■ / ■ / ■
Signal processing: Peak / Valley / AVG / Advanced hold	■ / ■ / ■ / ■	■ / ■ / ■ / ■	■ / ■ / ■ / ■	■ / ■ / ■ / ■	■ / ■ / ■ / ■
T <sub>Amb</sub> Head min.	–20 °C	–20 °C	–20 °C	–20 °C	–20 °C
T <sub>Amb</sub> Head max.	85 °C	85 °C	85 °C	85 °C	85 °C
T <sub>Amb</sub> Electronics max.	85 °C	85 °C	85 °C	85 °C	85 °C
Functional inputs/number	– / –	– / –	– / –	■ / 3	■ / 3
External emissivity adjustment	–	–	–	■	■
External background temperature control	–	–	–	■	■
Trigger input for reset of hold functions	–	–	–	■	■
Digital I/O pins/number	–	–	–	–	–
Simultaneous analog and digital output	■	■	■	■	■
Alarm output as alternative to analog output	■	■	■	■	■
Additional alarm output/switching output	■	■	■	■	■
Scope of supply	5–30 VDC	5–30 VDC	5–28 VDC	8–36 VDC	8–36 VDC
Standard cable length	3 m	3 m	3 m	3 m	3 m
Cable length options	8 / 15 m	8 / 15 m	3 m / 8 m / 15 m	8 / 15 m	8 / 15 m

Spot size calculator:  
[www.optris.com/spot-size-calculator](http://www.optris.com/spot-size-calculator)



CTlaser	CTlaser	CT XL	CTlaser	CTlaser	CTlaser	CTratio
1M / 2M	3M	3M	MT / F2 / F6	G5	P7	1M
Two-piece sensor with separate electronic box for high temp. measurement of metal, incl. programming keys and display	Two-piece sensor with separate electronic box for low temp. measurement of metal, incl. programming keys and display	Two-piece sensor with separate electronic box for laser applications, incl. programming keys and display (no laser)	Two-piece sensor with separate electronic box incl. progr. keys and display for measurement: MT: through flames F2: CO <sub>2</sub> flame gas F6: CO flame gas	Two-piece sensor with separate electronic box for measurement of glass, incl. programming keys and display	Two-piece sensor with separate electronic box for measurement of plastic foils, incl. programming keys and display	Ratio pyrometer with separate electronic box for high temp. measurement of metal feat. glass fiber cable and laser, incl. programming keys and display
1M: Si / 2M: InGaAs	Extended InGaAs	Extended InGaAs	Thermopile	Thermopile	Thermopile	Si sandwich
■ [+CT 1M / 2M]	■ [+CT 3M]	–	■	■	■	–
■ [max. 6 m]	■ [max. 6 m]	■	■ [max. 6 m]	■ [max. 6 m]	■ [max. 6 m]	–
M48x1.5	M48x1.5	M30x1	M48x1.5	M48x1.5	M48x1.5	M18x1
1M: 1.0 µm 2M: 1.6 µm	2.3 µm	2.3 µm	MT: 3.9 µm / F2: 4.24 µm / F6: 4.64 µm	5.0 µm	7.9 µm	0.7 – 1.1 µm
1ML: 485 °C ... 1050 °C 1MH: 650 °C ... 1800 °C 1MH1: 800 °C ... 2200 °C 2ML: 250 °C ... 800 °C 2MH: 385 °C ... 1600 °C 2MH1: 490 °C ... 2000 °C	L: 50 °C ... 400 °C H: 100 °C ... 600 °C H1: 150 °C ... 1000 °C H2: 200 °C ... 1500 °C H3: 250 °C ... 1800 °C	H: 100 °C ... 600 °C H1: 150 °C ... 1000 °C H2: 200 °C ... 1500 °C H3: 250 °C ... 1800 °C	200 °C ... 1650 °C	L: 100 °C ... 1200 °C H: 250 °C ... 1650 °C	0 °C ... 710 °C	700 °C ... 1800 °C
0.1 K	0.1 K	0.1 K	0.1 K	L: 0.1 K / H: 0.2 K	0.5 K	0.1 K (> 900 °C)
L: 150:1 H: 300:1	L: 60:1 / H: 100:1 / H1-H3: 300:1	H: 100:1 H1-H3: 300:1	45:1	L: 45:1 H: 70:1	45:1	40:1
–	–	–	–	–	–	–
0.5 mm @ 150 mm	0.7 mm @ 70 mm	0.7 mm @ 70 mm	1.6 mm @ 70 mm	1 mm @ 70 mm	1.6 mm @ 70 mm	7.7 mm @ 305 mm
3.7 mm @ 1100 mm	11 mm @ 1100 mm	11 mm @ 1100 mm	27 mm @ 1200 mm	17 mm @ 1200 mm	27 mm @ 1200 mm	31.3 mm @ 1143 mm
Double laser	Double laser	–	Double laser	Double laser	Double laser	Laser
1 ms	1 ms	1 ms	10 ms	L: 120 ms / H: 80 ms	150 ms	5 ms
±(0,3% T <sub>meas</sub> +2 °C)	±(0,3% T <sub>meas</sub> +2 °C)	±(0,3% T <sub>meas</sub> +2 °C)	±1.5 °C or ±1 %	±1 °C or ±1 %	±1.5 °C or ±1 %	±(0,5% T <sub>meas</sub> +1 °C)
■ / ■ / ■ / ■ / ■	■ / ■ / ■ / ■ / ■	■ / ■ / ■ / ■ / ■	■ / ■ / ■ / ■ / ■	■ / ■ / ■ / ■ / ■	■ / ■ / ■ / ■ / ■	■ / ■ / ■ / ■ / –
–	–	–	■	■	■	–
■ / ■ / ■ / ■ / ■	■ / ■ / ■ / ■ / ■	■ / ■ / ■ / ■ / ■	■ / ■ / ■ / ■ / ■	■ / ■ / ■ / ■ / ■	■ / ■ / ■ / ■ / ■	– / – / – / – / –
■ / ■ / ■ / ■	■ / ■ / ■ / ■	■ / ■ / ■ / ■	■ / ■ / ■ / ■	■ / ■ / ■ / ■	■ / ■ / ■ / ■	■ / ■ / ■ / ■
–20 °C	–20 °C	–20 °C	–20 °C	–20 °C	–20 °C	–20 °C
85 °C	85 °C	85 °C	85 °C	85 °C	85 °C	250 °C
85 °C	85 °C	85 °C	85 °C	85 °C	85 °C	85 °C
■ / 3	■ / 3	■ / 3	■ / 3	■ / 3	■ / 3	– / –
■	■	■	■	■	■	–
■	■	■	■	■	■	–
■	■	■	■	■	■	■ (via I/O pins)
–	–	–	–	–	–	■ / 2
■	■	■	■	■	■	■
■	■	■	■	■	■	■ (via I/O pins)
8–36 VDC	8–36 VDC	8–36 VDC	8–36 VDC	8–36 VDC	8–36 VDC	8–36 VDC
3 m	3 m	3 m	3 m	3 m	3 m	3 m
8 / 15 m	8 / 15 m	–	8 / 15 m	8 / 15 m	8 / 15 m	6 / 10 / 15 / 22 m

# INFRARED VIDEO THERMOMETERS

Infrared video thermometers with vario focus and patented cross hair laser



Base Modell	CSvideo	CTvideo	CTvideo
Type	2M (L/H)	1M / 2M (L/H)	3M (L/H)
Classification / special features	Single-piece two wire sensor with electronics in sensing head, video camera and cross hair laser for measuring metal	Two-piece sensor with electronic box for high temperature measurement of metals, video camera and cross hair laser	Two-piece sensor with electronic box for low temperature measurement of metals, video camera and cross hair laser
Detector	InGaAs	<b>1M:</b> Si / <b>2M:</b> InGaAs	Extended InGaAs
Sensing head exchangeable	–	[+CT 1M / 2M]	[+CT 3M]
Head cable shortening	■	[max. 6 m]	[max. 6 m]
Thread (sensing head)	M48x1.5	M48x1.5	M48x1.5
Spectral range	1.6 µm	<b>1M:</b> 1.0 µm / <b>2M:</b> 1.6 µm	2.3 µm
Temperature ranges (scalable via software)	250 °C ... 800 °C (2ML) 385 °C ... 1600 °C (2MH)	485 °C ... 1050 °C (1ML) 650 °C ... 1800 °C (1MH) 800 °C ... 2200 °C (1MH1) 250 °C ... 800 °C (2ML) 385 °C ... 1600 °C (2MH) 490 °C ... 2000 °C (2MH1)	50 °C ... 400 °C (3ML) 100 °C ... 600 °C (3MH) 150 °C ... 1000 °C (3MH1) <sup>1)</sup> 200 °C ... 1500 °C (3MH2) <sup>1)</sup> 250 °C ... 1800 °C (3MH3) <sup>1)</sup>
Temperature resolution	0.1 K	<b>ML:</b> 0.1 K / <b>MH:</b> 0.2 K	0.1 K
Optical resolution	<b>2MH:</b> 300:1 / <b>2ML:</b> 150:1	<b>L:</b> 150:1 / <b>H:</b> 300:1	<b>L:</b> 60:1 / <b>H:</b> 100:1 / <b>H1 – H3:</b> 300:1
Smallest spot (CF optics) CF vario optics: focusable from 90 mm to 250 mm	<b>2ML:</b> 0.6 mm @ 90 mm (CF) <b>2MH:</b> 0.3 mm @ 90 mm (CF)	<b>1ML/2ML:</b> 0.6 mm @ 90 mm (CF) <b>1MH-H1/ 2MH-H1:</b> 0.3 mm @ 90 mm (CF)	<b>3ML:</b> 1.5 mm @ 90 mm (CF) <b>3MH:</b> 0.9 mm @ 90 mm (CF) <b>3MH1 – H3:</b> 0.3 mm @ 90 mm (CF)
Smallest spot (SF optics) SF vario optics: focusable from 200 mm to infinity	<b>2ML:</b> 1.3 mm @ 200 mm (SF) <b>2MH:</b> 0.7 mm @ 200 mm (SF)	<b>1ML/2ML:</b> 1.3 mm @ 200 mm (SF) <b>1MH-H1/ 2MH-H1:</b> 0.7 mm @ 200 mm (SF)	<b>3MH:</b> 3.3 mm @ 200 mm (SF) <b>3MH:</b> 2.0 mm @ 200 mm (SF) <b>3MH1 – H3:</b> 0.7 mm @ 200 mm (SF)
Sighting	video camera and cross hair laser	video camera and cross hair laser	video camera and cross hair laser
Response time (90 %)	10 ms	1 ms	1 ms
Accuracy	±(0.3 % T <sub>meas</sub> +2 °C)	±(0.3 % T <sub>meas</sub> +2 °C)	±(0.3 % T <sub>meas</sub> +2 °C)
<b>Outputs analog:</b> 0–20 mA/ 4–20 mA/0–5 V/0–10 V/t/c (K/J)	– / ■ / – / – / –	■ / ■ / ■ / ■ / ■	■ / ■ / ■ / ■ / ■
<b>Interfaces:</b> USB / RS232 / RS485 / Profibus / Ethernet	■ / – / – / – / ■	■ / – / – / – / ■	■ / – / – / – / ■
<b>Signal processing:</b> Peak / Valley / AVG / Advanced hold	■ / ■ / ■ / ■	■ / ■ / ■ / ■	■ / ■ / ■ / ■
T <sub>Amb</sub> Head min.	–20 °C	–20 °C	–20 °C
T <sub>Amb</sub> Head max.	70 °C	85 °C	85 °C
T <sub>Amb</sub> Electronics max.	70 °C	85 °C	85 °C
Functional inputs / number	– / –	■ / 3	■ / 3
External emissivity adjustment	–	■	■
External background temperature control	–	■	■
Trigger input for reset of hold functions	–	■	■
Simultaneous analog and digital output	■	■	■
Alarm output as an alternative to analog output	■	■	■
Additional alarm output	0–30 V / 500 mA (open-collector)	24 V / 50 mA (open-collector)	24 V / 50 mA (open-collector)
Scope of supply	5–28 VDC	8–36 VDC	8–36 VDC
Standard cable length	3 m	3 m	3 m
Cable length options	8 / 15 m	5 / 10 m	5 / 10 m

1) Specifications available for object temperatures ≥ lower measurement range +50 °C



Software included

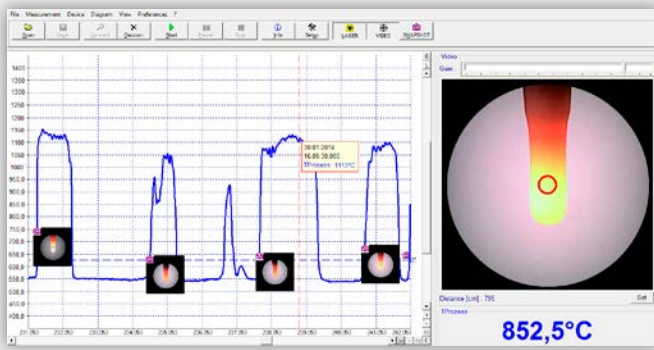

- Automatic snapshots (time or temperature dependent) to control and document the process
- Graphic display and recording of the measurement values
- Setup of sensor parameters and signal processing functions
- Remote control of the sensor

Connection options for CSvideo 2M

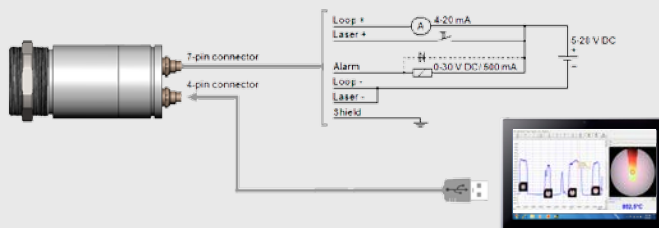

Analog operation mode: 4–20 mA and alarm interface. Setup & installation via USB cable (hot Plug & Play)



Digital operation mode: process control (video and temperature) via software

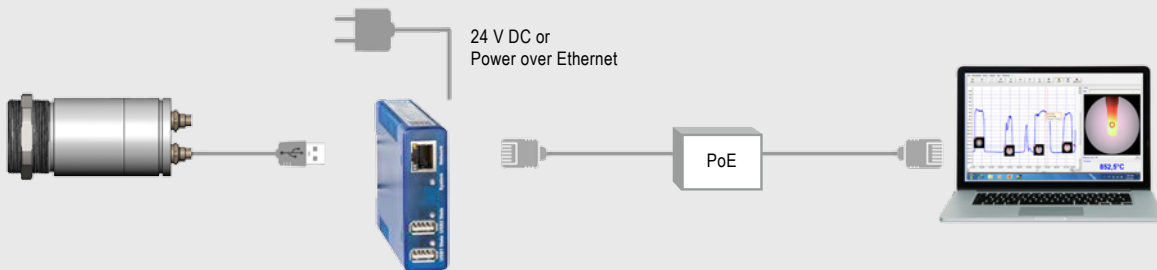

Connection options for CTvideo 1M / 2M / 3M

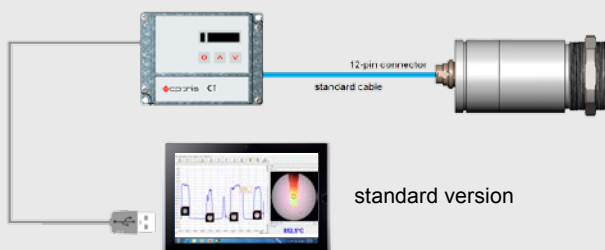

standard version

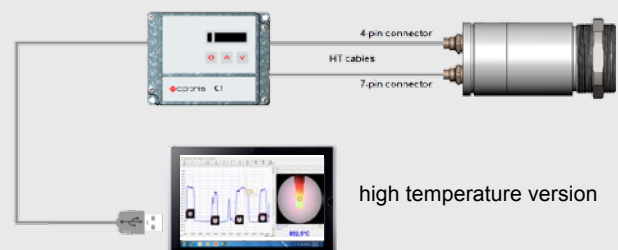

high temperature version

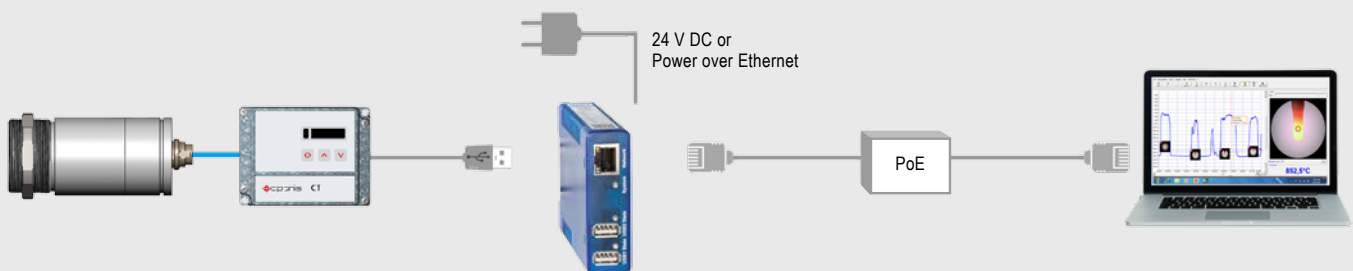

# INFRARED CAMERAS

Compact infrared cameras for fast online applications, including line scanning



Base Model	PI 160	PI 200 / PI 230	PI 400 / PI 450
<b>Type</b>	<b>IR</b>	<b>BI-SPECTRAL</b>	<b>IR</b>
Detector	FPA, uncooled (25 µm x 25 µm)	FPA, uncooled (25 µm x 25 µm)	FPA, uncooled (25 µm x 25 µm)
Optical resolution	160 x 120 pixel	160 x 120 pixel	382 x 288 pixel
Spectral range	7.5–13 µm	7.5–13 µm	7.5–13 µm
Temperature ranges	–20 °C ... 100 °C, 0 °C ... 250 °C, 150 °C ... 900 °C, additional range: 200 °C ... 1500 °C (option)*	–20 °C ... 100 °C, 0 °C ... 250 °C, 150 °C ... 900 °C, additional range: 200 °C ... 1500 °C (option)*	–20 °C ... 100 °C, 0 °C ... 250 °C, 150 °C ... 900 °C, additional range: 200 °C ... 1500 °C (option for PI 400)
Frame rate	120 Hz	128 Hz***	80 Hz
Optics (FOV)	23° x 17° FOV / f = 10 mm or 6° x 5° FOV / f = 35,5 mm or 41° x 31° FOV / f = 5,7 mm or 72° x 52° FOV / f = 3,3 mm	23° x 17° FOV** / f = 10 mm or 6° x 5° FOV / f = 35,5 mm or 41° x 31° FOV** / f = 5,7 mm or 72° x 52° FOV / f = 3,3 mm	38° x 29° FOV / f = 15 mm or 62° x 49° FOV / f = 8 mm or 13° x 10° FOV / f = 41 mm
Thermal sensitivity (NETD)	0.08 K with 23° x 17° FOV / F = 0.8 0.3 K with 6° x 5° FOV / F = 1.6 0.1 K with 41° x 31° FOV and 72° x 52° FOV / F = 1	0.08 K with 23° x 17° FOV / F = 0.8 0.3 K with 6° x 5° FOV / F = 1.6 0.1 K with 41° x 31° FOV and 72° x 52° FOV / F = 1	<b>PI 400:</b> 0.08 K <b>PI 450:</b> 0.04 K with 38° x 29° FOV / F = 0.8 <b>PI 400:</b> 0.08 K <b>PI 450:</b> 0.04 K with 62° x 49° FOV / F = 0.8 <b>PI 400:</b> 0.1 K <b>PI 450:</b> 0.06 K with 13° x 10° FOV / F = 1.0
<b>Option for visual camera</b> (only for BI-SPECTRAL camera)	–	Optical resolution: 640 x 480 pixel Frame rate: 32 Hz*** Optics (FOV): <b>PI 200:</b> 54° x 40°, <b>PI 230:</b> 30° x 23°	–
Accuracy	±2 °C or ±2 %, whichever is greater	±2 °C or ±2 %, whichever is greater	±2 °C or ±2 %, whichever is greater
PC interface	USB 2.0	USB 2.0	USB 2.0
<b>Process interface (PIF)</b>	Standard PIF 0–10 V input, digital input (max. 24 V), 0–10 V output  Industrial PIF (option) 2 x 0–10 V inputs, digital input (max. 24 V), 3 x 0–10 V outputs, 3 x relay (0–30 V / 400 mA), fail-safe relay	0–10 V input, digital input (max. 24 V), 0–10 V output	0–10 V input, digital input (max. 24 V), 0–10 V output  2 x 0–10 V inputs, digital input (max. 24 V), 3 x 0–10 V outputs, 3 x relay (0–30 V / 400 mA), fail-safe relay
Ambient temperature (T <sub>Amb</sub> )	0 °C ... 50 °C	0 °C ... 50 °C	<b>PI 400:</b> 0 °C ... 50 °C / <b>PI 450:</b> 0 °C ... 70 °C
Storage temperature	–40 °C ... 70 °C	–40 °C ... 70 °C	<b>PI 400:</b> –40 °C ... 70 °C <b>PI 450:</b> –40 °C ... 85 °C
Relative humidity	20–80 %, non-condensing	20–80 %, non-condensing	20–80 %, non-condensing
Housing (size/ rating)	45 mm x 45 mm x 62 mm / IP 67 (NEMA 4)	45 mm x 45 mm x 62 mm / IP 67 (NEMA 4)	46 mm x 56 mm x 90 mm / IP 67 (NEMA 4)
Weight	195 g, incl. lens	215 g, incl. lens	320 g, incl. lens
Shock/ vibration	<b>Shock:</b> IEC 60068-2-27 (25 g and 50 g) <b>Vibration:</b> IEC 60068-2-6 (sinus-shaped)/ IEC 60068-2-64 (broadband noise)	<b>Shock:</b> IEC 60068-2-27 (25 g and 50 g) <b>Vibration:</b> IEC 60068-2-6 (sinus-shaped)/ IEC 60068-2-64 (broadband noise)	<b>Shock:</b> IEC 60068-2-27 (25 g and 50 g) <b>Vibration:</b> IEC 60068-2-6 (sinus-shaped)/ IEC 60068-2-64 (broadband noise)
Tripod mount	¼-20 UNC	¼-20 UNC	¼-20 UNC
Scope of supply	via USB	via USB	via USB
Classification (standard)	<ul style="list-style-type: none"> <li>• USB camera incl. 1 lens</li> <li>• USB cable (1 m)</li> <li>• table tripod</li> <li>• PIF cable incl. terminal block (1 m)</li> <li>• software package optris PI Connect</li> <li>• aluminum case</li> </ul>	<ul style="list-style-type: none"> <li>• USB camera (BI-SPECTRAL) incl. 1 lens</li> <li>• USB cable (1 m)</li> <li>• table tripod</li> <li>• focusing tool</li> <li>• PIF cable incl. terminal block (1 m)</li> <li>• software package optris PI Connect</li> <li>• aluminum case</li> </ul>	<ul style="list-style-type: none"> <li>• USB camera incl. 1 lens</li> <li>• USB cable (1 m)</li> <li>• table tripod</li> <li>• PIF cable incl. terminal block (1 m)</li> <li>• software package optris PI Connect</li> <li>• aluminum case (PI 400)</li> <li>• hard transport case (PI 450)</li> </ul>

\* The additional range is not available for 72° HFOV optics

\*\* For ideal combination of IR and VIS image, a 41° HFOV lens is recommended (optris PI 200). For the PI 230, a 23° lens is recommended.

**Optics calculator:**  
[www.optris.com/optics-calculator](http://www.optris.com/optics-calculator)



PI 450 G7	PI 640	PI 1M
<b>IR</b>	<b>IR</b>	<b>IR</b>
FPA, uncooled (25 µm x 25 µm)	FPA, uncooled (17 µm x 17 µm)	CMOS (15 µm x 15 µm)
382 x 288 pixel	640 x 480 pixel VGA	382 x 288 pixel @ 80 Hz, switchable to 27 Hz, 72 x 56 pixel @ 1000 Hz
7.9 µm	7.5–13 µm	0.92–1.1 µm
200 ... 1500 °C	-20 ... 100 °C, 0 ... 250 °C, 150 ... 900 °C	450 ... 1500 °C (550 ... 1500 °C @ 1 kHz mode)
80 Hz / switchable to 27 Hz	32 Hz	–
38° x 29° / f = 15 mm 62° x 49° / f = 8 mm	33° x 25° / f = 19 mm 60° x 45° / f = 10 mm 90° x 66° / f = 7 mm	FOV @ 382 x 288 px: 51° x 39° / f = 6 mm 26° x 20° / f = 12 mm 20° x 15° / f = 16 mm 13° x 10° / f = 25 mm 6.2° x 4.7° / f = 50 mm 4.0° x 3.0° / f = 75 mm
130 mK	75 mK	< 1 K (700 °C) < 2 K (1000 °C)
–	–	–
±2 °C or ±2 %, whichever is greater	±2 °C or ±2 %, whichever is greater	±2 °C or ±2 %, whichever is greater
USB 2.0	USB 2.0	USB 2.0
0–10 V input, digital input (max. 24 V), 0–10 V output	0–10 V input, digital input (max. 24 V), 0–10 V output	0–10 V input, digital input (max. 24 V), 0–10 V output
2 x 0–10 V inputs, digital input (max. 24 V), 3 x 0–10 V outputs, 3 x relay (0–30 V / 400 mA), fail-safe relay	2 x 0–10 V inputs, digital input (max. 24 V), 3 x 0–10 V outputs, 3 x relay (0–30 V / 400 mA), fail-safe relay	2 x 0–10 V inputs, digital input (max. 24 V), 3 x 0–10 V outputs, 3 x relay (0–30 V / 400 mA), fail-safe relay
0 ... 70 °C	0 ... 50 °C	0 ... 50 °C
-40 ... 85 °C	-40 ... 70 °C	-40 ... 70 °C
20–80 %, non-condensing	20–80 %, non-condensing	20–80 %, non-condensing
46 mm x 56 mm x 90 mm / IP 67 (NEMA 4)	46 mm x 56 mm x 90 mm / IP 67 (NEMA 4)	46 mm x 50 mm x 90 mm / IP 67 (NEMA 4)
320 g, incl. lens	320 g, incl. lens	320 g, incl. lens
<b>Shock:</b> IEC 60068-2-27 (25 g and 50 g) <b>Vibration:</b> IEC 60068-2-6 (sinus-shaped)/ IEC 60068-2-64 (broadband noise)	<b>Shock:</b> IEC 60068-2-27 (25 g and 50 g) <b>Vibration:</b> IEC 60068-2-6 (sinus-shaped)/ IEC 60068-2-64 (broadband noise)	<b>Shock:</b> IEC 60068-2-27 (25 g and 50 g) <b>Vibration:</b> IEC 60068-2-6 (sinus-shaped)/ IEC 60068-2-64 (broadband noise)
¼-20 UNC	¼-20 UNC	¼-20 UNC
via USB	via USB	via USB
<ul style="list-style-type: none"> <li>• USB camera incl. 1 lens</li> <li>• USB cable (1 m)</li> <li>• table tripod</li> <li>• PIF cable incl. terminal block (1 m)</li> <li>• software package optris PI Connect</li> <li>• hard transport case</li> </ul>	<ul style="list-style-type: none"> <li>• USB camera incl. 1 lens</li> <li>• USB cable (1 m)</li> <li>• table tripod</li> <li>• PIF cable incl. terminal block (1 m)</li> <li>• software package optris PI Connect</li> <li>• hard transport case</li> </ul>	<ul style="list-style-type: none"> <li>• USB camera incl. 1 lens</li> <li>• lens protection tube incl. protective window</li> <li>• USB cable (1 m)</li> <li>• table tripod</li> <li>• PIF cable incl. terminal block (1 m)</li> <li>• software package optris PI Connect</li> <li>• aluminum case</li> <li>• optional: CoolingJacket, high temperature cable</li> </ul>

\*\*\* The following options can be set:

- Option 1 (IR with 96 Hz at 160 x 120 px; VIS with 32 Hz at 640 x 480 px)
- Option 2 (IR mit 128 Hz at 160 x 120 px; VIS with 32 Hz at 596 x 447 px)

# INFRARED CAMERAS

## EXPANSION OPTIONS



### PI LightWeight – for flight applications with PI series

#### Features:

- Full radiometric IR inspection with 382 x 288 pixels in 12 ms per frame
- 380 g two-piece design with minimized camera head weight
- Simultaneous 20 Hz video signal generation parallel to 35 Hz on board radiometric recording
- Flexible data acquisition and analysis software PI Connect
- GigE connection for after flight video download and software adjustments via “remote desktop”
- Support for HD video camera (GoPro) readout via additional USB port



### PI NetBox

#### Features:

- Miniaturized PC for PI160/ 4xx stand-alone operation or for cable extension
- Supports 120 Hz (up to 70 Hz for PI4xx) frame rate
- Integrated watchdog feature
- Additional operation of customer specific software
- Processor: Intel® Atom™ Z530 @ 1,6 GHz, 4 GB SSD, 1 GB RAM
- Status LEDs
- Ports: 3x USB 2.0, 1x Mini-USB in slave mode, VGA/ Video, Gigabit Ethernet, micro SDCard (up to 32 GB)
- Operating system: Windows XP Professional
- Wide power range: 8-48 VDC or Power over Ethernet (PoE)
- Low power consumption (max. 9.5 W)
- Up to 20 m USB high temperature cable, up to 100 m Ethernet cable expandability (PoE)



### USB Server Gigabit – for infrared cameras of optris® PI series

#### Features:

- Fully USB 2.0 compatible, Data rates: 1.5 / 12 / 480 mbps, USB transfer modes: Control, Bulk, Interrupt, Isochronous
- Network connection via Gigabit Ethernet
- For optris® PI series and optris® CTvideo/ CSvideo series
- Full TCP/IP support incl. routing and DNS
- Two independent USB ports
- Supply from PoE or external power supply with 24 – 48 V DC
- Galvanic isolation 500 V<sub>RMS</sub> (network connection)
- Remotely configurable via Web Based Management
- Proven technology from Wiesemann & Theis



### Industrial process interface (PIF)

#### Features:

- Industrial process interface with 3 analog/alarm outputs, 2 analog inputs, 1 digital input, 3 alarm relays
- 500 V<sub>AC</sub><sub>RMS</sub> isolation voltage between camera and process
- Separate fail-safe relay output
- PI hardware including all cable connections and PI Connect software are permanently observed during operation

### Connection options for PI LightWeight

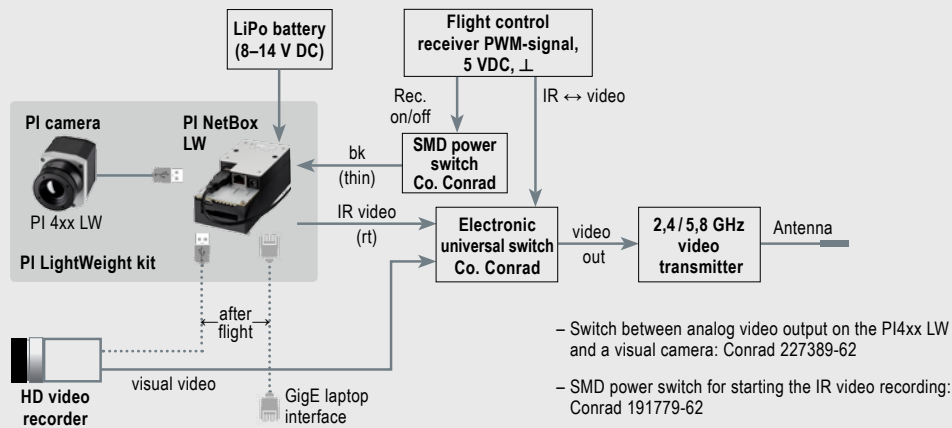

### Connection options for PI NetBox

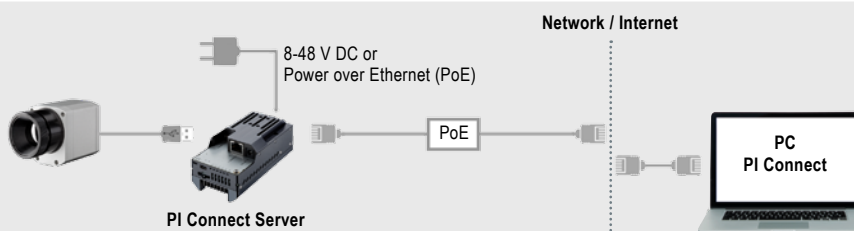

### Connection options for USB Server Gigabit

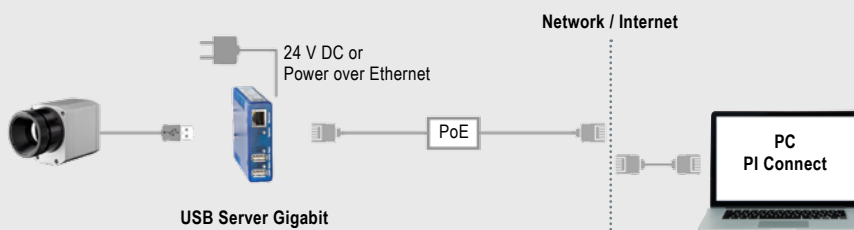

### Example for a fail-safe monitoring of the PI with a connected PLC

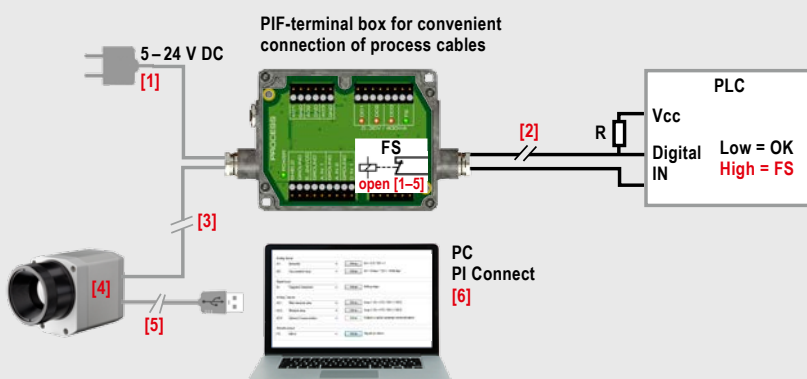

#### Fail-safe monitoring states

- [1] Breakdown of PIF power supply
- [2] Cable break of fail-safe cable
- [3] Interruption of cable PI-PIF
- [4] Malfunction of PI
- [5] Breakdown of PI power supply/ Interruption of USB cable
- [6] Malfunction of PI Connect software

#### Fail-safe status:

Normal: relay closed LED on  
 Alarm: relay open LED off

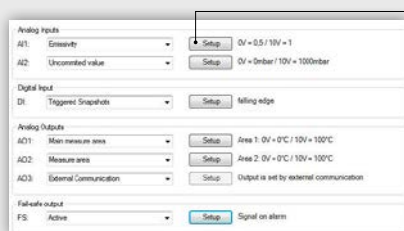

Snapshot of programmable features

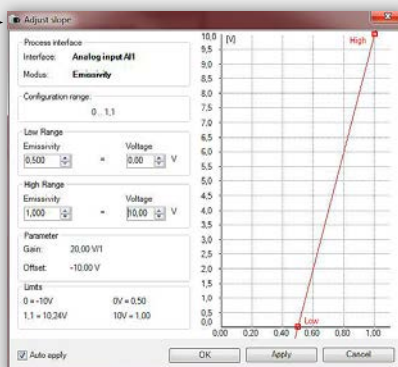

## Software

### 1 Extensive infrared camera software

- No additional costs
- No restrictions in licencing
- Modern software with intuitive user interface
- Remote control of camera via software
- Display of multiple camera images in different windows
- Compatible with Windows XP, Vista, 7, 8 and Linux (ubuntu)
- Extensive license-free analysis and complete SDK inclusive



### 2 Extensive online and offline data analysis

- Real-time temperature information within main window as digital or graphic display
- Analysis supported by measurement fields, automatic hot and cold spot searching
- Logic operation of temperature information (measurement fields and image substraction)
- Slow motion repeat of radiometric files and analysis without camera being connected
- Editing of sequences such as cutting and saving of individual images
- Various color palettes to highlight thermal contrasts

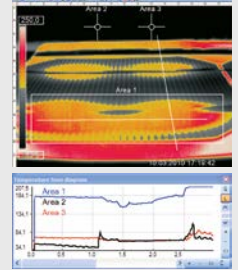

### 3 High level of individualization for customer

- Different layout options for an individual setup (arrangement of windows, toolbar)
- Temperature display in °C or °F
- Various language options including a translation tool
- Range of individual measurement parameters appropriate for each application
- Adaption of thermal image (mirror, rotate)
- Individual start options (full screen, hidden, etc.)

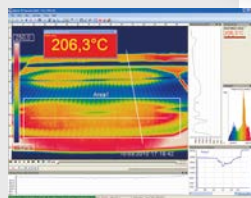

### 4 Automatic process and quality control

- Individual setup of alarm levels depending on the process
- BI-SPECTRAL process monitoring (IR and VIS) for easy orientation at point of measurement
- Definition of visual or acoustic alarms and analog data output via the process interface
- Analog and digital signal input (process parameter)
- External communication of software via Comports and DLL
- Adjustment of thermal image via reference values



### 5 Video recording and snapshot function (IR or BI-SPECTRAL)

- Recording of video sequences and detailed frames for further analysis or documentation
- BI-SPECTRAL video analysis (IR and VIS) in order to highlight critical temperatures
- Adjustment of recording frequency to reduce data volume
- Display of snapshot history for immediate analysis

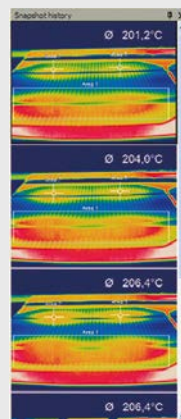

### 6 Temperature data analysis and documentation

- Triggered data collection
- Radiometric video sequences (\*.ravi)
- Radiometric snapshots (\*.tiff)
- Text files including complete temperature information for analysis in Excel (\*.csv, \*.dat)
- Data with color information for standard programs such as Photoshop or Windows Media Player (\*.avi, \*.tiff)
- Data transfer in real time to other software programs via DLL or COM-Port interfaces

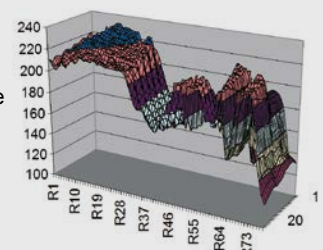

High-quality infrared thermometers with integrated USB interface



Base Model	LS	P20	P20	MS	MSPlus	MSPro
Type	LT	LT	1M / 2M / 05M	LT	LT	LT
Detector	Thermopile	Thermopile	Si / InGaAs	Thermopile	Thermopile	Thermopile
Spectral range	8–14 μm	8–14 μm	1M: 1.0 μm 2M: 1.6 μm 05M: 525 nm	8–14 μm	8–14 μm	8–14 μm
Temperature ranges	–35 °C ... 900 °C	0 °C ... 1300 °C	1M: 650 °C ... 1800 °C 2M: 385 °C ... 1600 °C 05M: 1000 °C ... 2000 °C	–32 °C ... 420 °C	–32 °C ... 530 °C	–32 °C ... 760 °C
Temperature resolution	0,1 K	1 K	1 K	0.2 K	0.1 K	0.1 K
Optical resolution	75:1	120:1	1M / 2M: 300:1 05M: 150:1	20:1	20:1	40:1
Switchable optics	■	–	–	–	–	–
Smallest spot (CF optics)	1 mm @ 62 mm	–	–	–	–	–
Smallest spot (SF optics)	16 mm @ 1200 mm	100 mm @ 12 m	1M / 2M: 12 mm @ 3.6 m 05M: 24 mm @ 3.6 m	13 mm @ 140 mm	13 mm @ 140 mm	13 mm @ 260 mm
Sighting	Cross hair laser	Double laser	Double laser	Laser	Laser	Laser
Response time (90 %)	150 ms	300 ms	100 ms	300 ms	300 ms	300 ms
Accuracy	±0.75 °C or ±0.75 %	±2 °C or ±1 %	±(0.3 % T <sub>meas</sub> +2 °C)	±1 °C or ±1 %	±1 °C or ±1 %	±1 °C or ±1 %
PC interface	USB	USB	USB	USB	USB	USB
Software	■	■	■	■	■	■
Probe connection (t/c)	■	–	–	–	–	■
T <sub>Amb</sub> Min. / Max.	0 °C / 50 °C	0 °C / 50 °C	0 °C / 50 °C	0 °C / 50 °C	0 °C / 50 °C	0 °C / 50 °C
Display MAX / MIN / HOLD	■	■	■	■	■	■
HIGH / LOW alarm	■	■	■	–	■	■
Data logger / capacity	■ / 100	■ / 2000	■ / 2000	–	–	■ / 20
Emissivity	0.100 ... 1.100	0.100 ... 1.100	0.100 ... 1.100	0.95 fixed	0.100 ... 1.100	0.100 ... 1.100

## Best optics for portable thermometers

The optics of the portable thermometers are designed for mean distances. The **optris® LS LT** comes with a unique, **switchable lens** which means that smaller objects can be precisely measured in a close-up range.

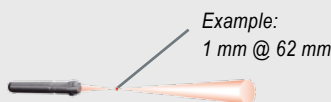

Close lens (CF, close focus): Measurement of smallest objects under test close to the sensor (only optris® LS LT)



Standard lens (SF, standard focus): Measurement of smallest objects under test in mean distances



# APPLICATION FIELD

## Laminating of vehicle interior



Vehicle interiors are partly equipped with different surface decors during a laminating process. The decor temperature is controlled and optimized during this time.

Product: optris® CSmicro LT

## Function tests of assembled circuit boards

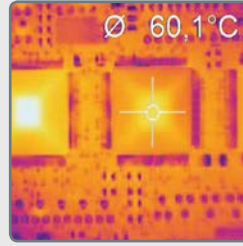

More and more manufacturers of electronic components and circuit boards are turning to the use of non-contact temperature measurement due to the increasing productivity of their components.

Product: optris® PI 450

## Production of glass syringes



During the production of glass syringes, the needle is glued to the glass tube. Punctual measuring pyrometers are used to monitor and control the process and ensure the quality of the syringes.

Product: optris® CTfast LT

## Hot deforming of metals



Narrow temperature limits need to be met during hot deforming processes of metal. Handheld devices can be used for sporadic monitoring in forging and bending processes.

Product: optris® P20 2M

## Induction heating processes



Induction heating has acquired high importance within the area of heat treatment of metal. The aimed-for texture structure of the metal depends on the ideal temperature time process.

Product: optris® CTlaser 1M

## Preventive electrical maintenance

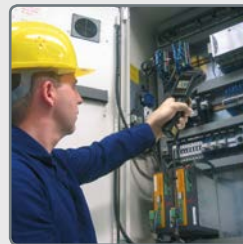

Almost every current asset which is supported by energy turns hot before a breakdown. Temperature monitoring can best be provided in line with preventive electronic maintenance.

Product: optris® LS LT

[site:www.open17.com](http://www.open17.com)

innovative infrared technology