



- Completely sealed switching chamber
- Three types of terminals
- UL approved

ELECTRICAL SPECIFICATIONS

- Max. current/voltage rating with resistive load and electrical life at full load: see table below
- Initial contact resistance : 10 mΩ max. at 1A 2VDC
- Insulation resistance : 1.000 MΩ min. at 500VDC
- Dielectric strength : 2.500 Vrms 50 Hz min. between terminals
3.000 Vrms 50 Hz min. between terminals and frame

ELECTRICAL RATING AND LIFE

		Alternate current	Direct current	UL
SINGLE POLE	ON-OFF and ON-ON	15A 125/250VAC resistive 10.000 cycles	15A 28VDC resistive 5A 28VDC lamp load 10.000 cycles	10A 125/250 VAC according to UL 1054
	Other functions	10A 125/250VAC resistive 10.000 cycles	10.000 cycles, T20°C 15A 28VDC resistive 15A 28VDC inductive 5A 28VDC lamp load	
DOUBLE POLE	ON-OFF and ON-ON	15A 125/250VAC resistive 10.000 cycles	15A 28VDC resistive 5A 28VDC lamp load 10.000 cycles	
	Other functions	10A 125/250VAC resistive 10.000 cycles	10.000 cycles, T20°C 15A 28VDC resistive 15A 28VDC inductive 5A 28VDC lamp load	

MATERIALS

- Case : mineral filled polyester UL94-V0
- Bushing and cover : zamac
- Actuator : bright nickel
- Contacts : silver alloy
Gold plated : on request

AGENCY APPROVAL



File E83438

Availability : consult factory for details of approved models.

Marking : to order switches marked UL, complete appropriate box of ordering format.

GENERAL SPECIFICATIONS

- Torque : 2 Nm (1.47 Ft.lb) max. applied to nut
- Panel thickness : see "Mounting Accessories" on the following pages
- Mechanical life : 100.000 cycles
- Operating temperature : -40°C to +85°C
- Front panel sealing : IP67

CT series

Sealed toggle switches

Overview

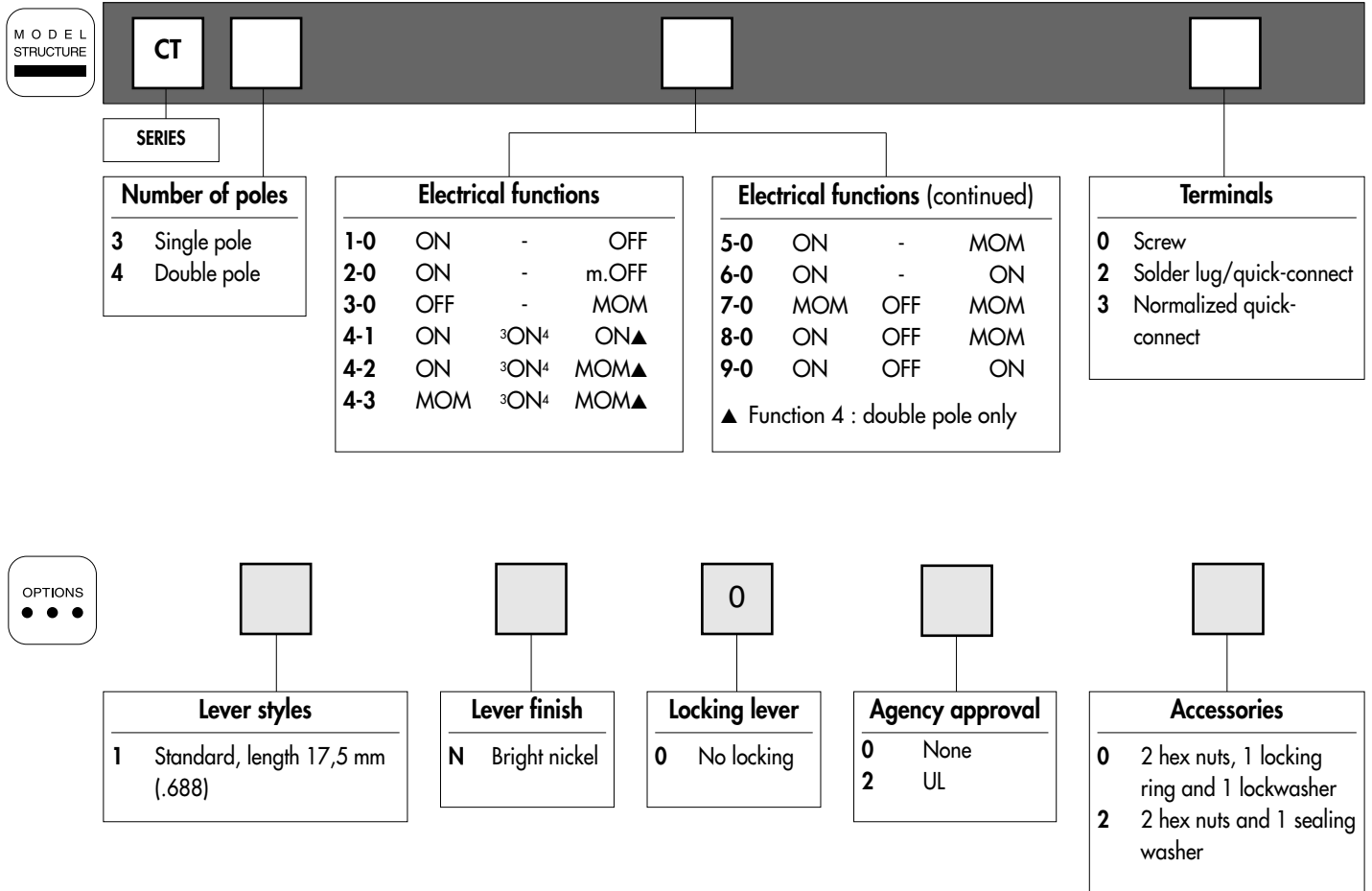

APEM has the ability to develop custom configurations. Please contact us with your requirements.



NOTICE : please note that not all combinations of above numbers are available. Refer to the following pages for further information.

ABOUT THIS SERIES

On the following pages, you will find successively :

- model structure of switches
- their options in the same order as in above chart

Dimensions : first dimensions are in mm while inches are shown as bracketted numbers.

Security caps are available to prevent inadvertent lever operation. On request.



Packaging unit : 25 pieces



CT series

Sealed toggle switches

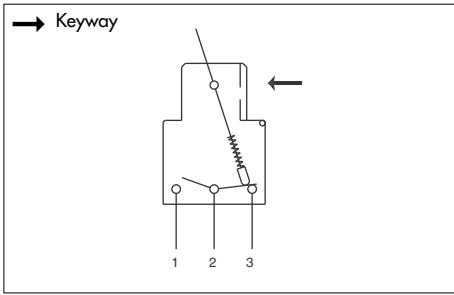

- Screw, solder lug or quick-connect terminals

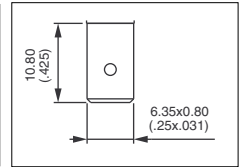
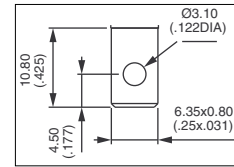
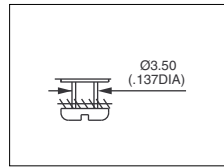

MODEL STRUCTURE

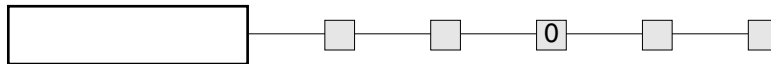

Shown with standard lever



FUNCTIONS			BASIC PART NUMBER					
			Screw terminals		Solder lugs and quick-connect term.		Normalized quick-connect terminals	
III A2-A3 B5-B6	II *A3-B4 A1-B6	I A1-A2 B5-B4	Single pole	Double pole	Single pole	Double pole	Single pole	Double pole
ON	-	OFF	CT31-00	CT41-00	CT31-02	CT41-02	CT31-03	CT41-03
ON	-	m.OFF	CT32-00	CT42-00	CT32-02	CT42-02	CT32-03	CT42-03
OFF	-	MOM	CT33-00	CT43-00	CT33-02	CT43-02	CT33-03	CT43-03
ON	ON*	ON		CT44-10		CT44-12		CT44-13
ON	ON*	MOM		CT44-20		CT44-22		CT44-23
MOM	ON*	MOM		CT44-30		CT44-32		CT44-33
ON	-	MOM	CT35-00	CT45-00	CT35-02	CT45-02	CT35-03	CT45-03
ON	-	ON	CT36-00	CT46-00	CT36-02	CT46-02	CT36-03	CT46-03
MOM	OFF	MOM	CT37-00	CT47-00	CT37-02	CT47-02	CT37-03	CT47-03
ON	OFF	MOM	CT38-00	CT48-00	CT38-02	CT48-02	CT38-03	CT48-03
ON	OFF	ON	CT39-00	CT49-00	CT39-02	CT49-02	CT39-03	CT49-03

→ Keyway

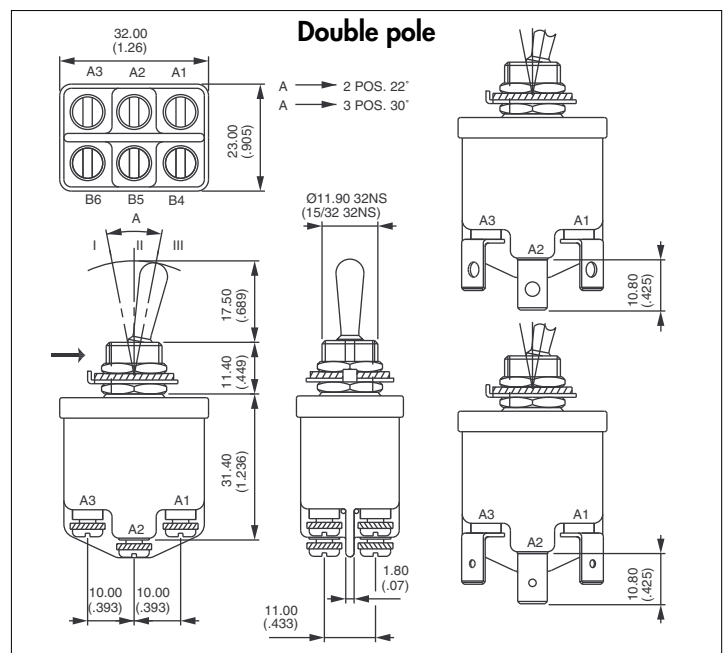
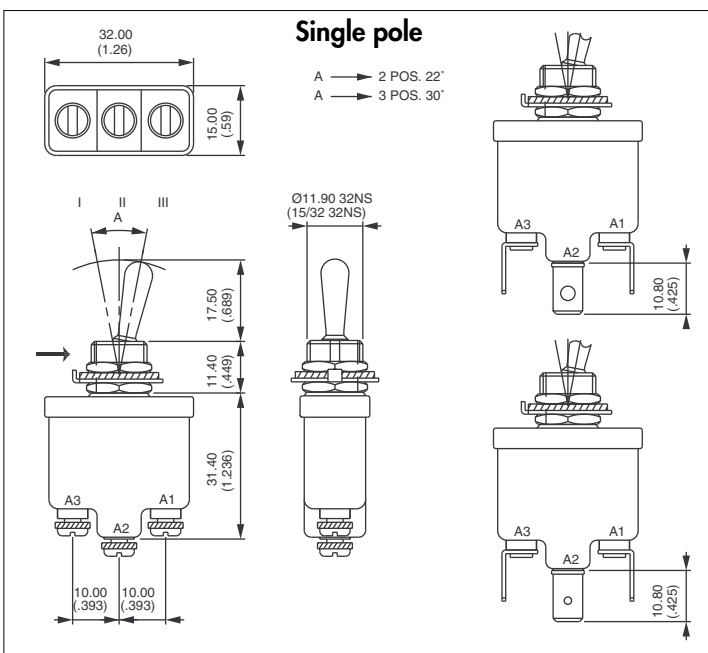

CT series

Sealed toggle switches



LEVER STYLES

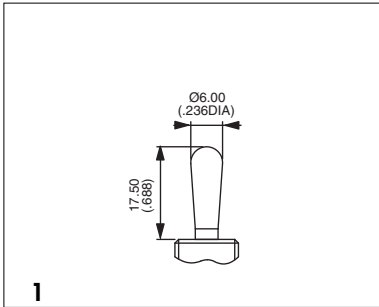
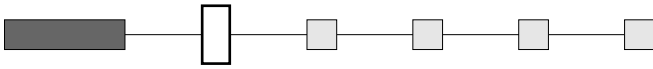

1

Standard

LEVER FINISH

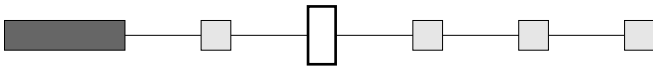

N Bright nickel

LOCKING LEVER

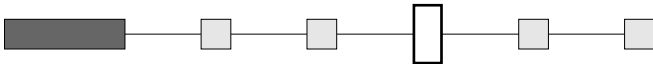

0 No locking

AGENCY APPROVAL

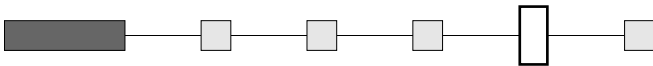

0 None
2 UL

APEM has the ability to develop custom configurations. Please contact us with your requirements.

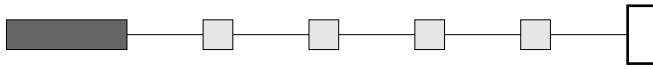
**MOUNTING ACCESSORIES**

- 0** For NON-SEALED mounting (panel cut-out fig. 1, 2 or 3)
2 hex nuts 14 mm (.551) across flats, 1 locking ring U121 or U12, 1 lockwasher U13
Panel thickness : 5 mm (.196) max.
- 2** For SEALED mounting (panel cut-out fig. 2)
2 hex nuts 14 mm (.551) across flats and 1 sealing washer U60
Panel thickness : 4 mm (.157) max.

Special hardware : black cap nut U129. Order separately.

