

This is only for reference, the actual product does not support all combinations. For selecting the specified model, follow the Autonics website.

T N ① - ② 4 ③ ④ ⑤ - ⑥ S - ⑦

① Size

S: DIN W 48 × H 48 mm
H: DIN W 48 × H 96 mm
L: DIN W 96 × H 96 mm

② Control method

No mark: Fixed control
P: Program control

③ Alarm outputs

2: Alarm 1 / 2
4: Alarm 1 / 2 / 3 / 4
6: Alarm 1 / 2 / 3 / 4 / 5 / 6

④ Control output 1

R: Relay
S: SSR drive
C: Current or SSR drive

⑤ Control output 2

R: Relay
S: SSR drive
C: Current or SSR drive

⑥ Communication

N: None
R: RS485

⑦ Option input/output

No.	Digital input	CT input	Transmission output
006	0	1	0
008	2	1	0
009	3	1	0
014	3	2	0
026	0	1	1
031	0	2	1
035	6	2	1

Two-Degree-of-Freedom PID Temperature Controllers



TN Series CATALOG

For your safety, read and follow the considerations written in the instruction manual, other manuals and Autonics website.

The specifications, dimensions, etc are subject to change without notice for product improvement. Some models may be discontinued without notice.

Features

- 2-DOF PID algorithm optimized for various control environments
- 50 ms high-speed sampling and $\pm 0.2\%$ display accuracy
- Program control and fixed control models available
 - Up to 10 patterns X 20 steps program setting (program control model)
 - Timer function for preset operation (fixed control model)
- Simultaneous heating/cooling and automatic/manual control function
- Control functions: Group PID, Zone PID, Anti Reset Windup (ARW)
- Control status monitoring of up to 10 events
- RS485 communication output model available
 - Communication protocols: Modbus RTU/ASCII, PLC ladderless, Sync-Master
 - Communication speed: up to 115,200bps
- Heater burnout alarm function (CT input)
- Parameter setting via PC
 - Comprehensive Device Management Software (DAQMaster) provided
 - Communication converter connection with front loader port (TNH, TNL only)
- Shortcut key setting with front user key button [U]
- Easy maintenance with detachable terminal blocks

Product Components

- Product
- Bracket
- Instruction manual

Specifications	
Power supply	100 - 240 VAC~, 50/60 Hz ±10%
Power consumption	≤ 8 VA
Display type	11 segment, LCD type (operating value display part: 7 segment)
Sampling period	50 / 100 / 250 ms (parameter)
Input specification	Refer to 'Input Type and Using Range'
Option input	CT <ul style="list-style-type: none"> • 0.0-50.0 A (primary current measurement range) • CT ratio: 1/1,000 • Measurement accuracy: ±5% F.S. ±1digit
	Digital <ul style="list-style-type: none"> • Contact - ON: ≤ 2 kΩ, OFF: ≥ 90 kΩ • Non contact - residual voltage ≤ 1.0 V, leakage current ≤ 0.1 mA • Outflow current: ≈ 0.5 mA per input
Control output	Relay 250 VAC~ 3A 1a
	SSR 12 VDC= ±2 V, ≤ 20 mA
Option output	Alarm 250 VAC~ 3 A 1a
	Transmission DC 4 - 20 mA (load resistance: ≤ 500 Ω, output accuracy: ±0.3% F.S.)
Control type	Communication RS485
	Type ON/OFF, P, PI, PD, PID
Program control	Multi SV ≤ 4 SV
	Group PID ≤ 8 group
	Zone PID 4 zones
	ARW (Anti Reset Windup) 50 to 200 %
Hysteresis	Program ≤ 10 patterns
	Step ≤ 200 steps (1 pattern: ≤ 20 steps)
	Setting type Time setting
Proportional band (P)	• Thermocouple, RTD: 1 to 100 (0.1 to 100.0) °C/°F
Integral time (I)	• Analog: 1 to 100 digit
Derivative time (D)	0.1 to 999.9 °C (0.1 to 999.9%)
Control cycle (T)	0 to 9,999 sec
Manual reset	0 to 9,999 sec
Dielectric strength	• Relay / SSR output: 0.1 to 120.0 sec
Vibration	• Selectable current or SSR drive output: 1.0 to 120.0 sec
Relay life cycle	0.0 to 100.0%
	Between the charging part and the case: 3,000 VAC~ 50/60 Hz for 1 min
Insulation resistance	0.75 mm amplitude at frequency of 5 to 55 Hz (for 1 min) in each X, Y, Z direction for 2 hours
	Mechanical <ul style="list-style-type: none"> • OUT1/2: ≥ 5,000,000 operations • AL1/2/3/4/5/6: ≥ 20,000,000 operations
Insulation type	Electrical <ul style="list-style-type: none"> • OUT1/2: ≥ 200,000 operations • AL1/2/3/4/5/6: ≥ 100,000 operations
	≥ 100 MΩ (500 VDC= megger)
Noise immunity	Double insulation or reinforced insulation (mark: □, dielectric strength between the measuring input part and the power part: 3 kv)
Memory retention	±2 kV square shaped noise by noise simulator (pulse width: 1 μs) R-phase, S-phase
Ambient temperature	≈ 10 years (non-volatile semiconductor memory type)
Ambient humidity	-10 to 50 °C, storage: -20 to 60 °C (no freezing or condensation)
Protection structure	35 to 85%RH
Loader port	IP65 (Front panel, IEC standards)
Accessory	• TNS: top side • TNH, TNL: front side
Unit weight (packaged)	Bracket
Approval	• TNS: ≈ 128 g (≈ 156 g) • TNH: ≈ 184 g (≈ 286 g)
	• TNL: ≈ 301 g (≈ 443 g)
	CE, RoHS, REACH

Input Type and Using Range					
The setting range of some parameters is limited when using the decimal point display.					
Input type	Decimal point	Display	Using range (°C)	Using range (°F)	
Thermo-couple	K (CA)	1	# C RH	-200 to 1,350	-328 to 2,463
		0.1	# C RL	-199.9 to 999.9	-199.9 to 999.9
	J (IC)	1	J I CH	-200 to 800	-328 to 1,472
		0.1	J I CL	-199.9 to 800.0	-199.9 to 999.9
	E (CR)	1	E C RH	-200 to 800	-328 to 1,472
		0.1	E C RL	-199.9 to 800.0	-199.9 to 999.9
	T (CC)	1	T C CH	-200 to 400	-328 to 752
		0.1	T C CL	-199.9 to 400.0	-199.9 to 752.0
	B (PR)	1	B PR	0 to 1,800	32 to 3,272
		1	R PR	0 to 1,750	32 to 3,182
	S (PR)	1	S PR	0 to 1,750	32 to 3,182
		1	N NN	-200 to 1,300	-328 to 2,372
C (TT) ⁰¹⁾	1	C EE	0 to 2,300	32 to 4,172	
	1	G TT) ⁰²⁾	0 to 2,300	32 to 4,172	
L (IC)	1	L I CH	-200 to 900	-328 to 1,652	
	0.1	L I CL	-199.9 to 900.0	-199.9 to 999.9	
L (RUS)	1	L RH	-200 to 800	-328 to 1,472	
	0.1	L RL	-199.9 to 800.0	-199.9 to 999.9	
U (CC)	1	U C CH	-200 to 400	-328 to 752	
	0.1	U C CL	-199.9 to 400.0	-199.9 to 752.0	
RTD	Platinel II	1	P L I I	0 to 1,390	32 to 2,534
	Cu50 Ω	0.1	C U 5	-199.9 to 200.0	-199.9 to 392.0
		0.1	C U 10	-199.9 to 200.0	-199.9 to 392.0
	JPt100 Ω	1	J P E H	-200 to 650	-328 to 1,202
		0.1	J P E L	-199.9 to 650.0	-199.9 to 999.9
	DPT50 Ω	0.1	d P E 5	-199.9 to 600.0	-199.9 to 999.9
		1	d P E H	-200 to 650	-328 to 1,202
	DPT100 Ω	0.1	d P E L	-199.9 to 650.0	-199.9 to 999.9
		1	N I 12	-80 to 200	-112 to 392
	Analog	0 to 10 V	-	R V 1	0 to 10 V
		0 to 5 V	-	R V 2	0 to 5 V
		1 to 5 V	-	R V 3	1 to 5 V
0 to 100 mV		-	R M V 1	0 to 100 mV	
0 to 20 mA		-	R M A 1	0 to 20 mA	
4 to 20 mA		-	R M A 2	4 to 20 mA	

• Permissible line resistance per line: ≤ 5 Ω
 01) C (TT): Same as existing W5 (TT) type sensor
 02) G (TT): Same as existing W (TT) type sensor

■ Display accuracy

Input type	Using temperature	Display accuracy
Thermo-couple RTD	At room temperature (23°C ±5 °C)	(PV ±0.2% or ±1 °C higher one) ±1-digit • Thermocouple K, J, T, N, E below -100 °C and L, U, PLII, RTD Cu50 Ω, DPT50 Ω: (PV ±0.3% or ±2 °C higher one) ±1-digit • Thermocouple C, G and R, S below 200 °C: (PV ±0.3% or ±3 °C higher one) ±1-digit • Thermocouple B below 400 °C: There is no accuracy standards
	Out of room temperature range	(PV ±0.5% or ±2 °C higher one) ±1-digit • RTD Cu50 Ω, DPT50 Ω: (PV ±0.5% or ±3 °C higher one) ±1-digit • Thermocouple R, S, B, C, G: (PV ±0.5% or ±5 °C higher one) ±1-digit • Other sensors: ≤ ±5 °C (≤-100 °C)
Analog	At room temperature (23°C ±5 °C)	±0.2% F.S. ±1-digit
	Out of room temperature range	±0.5% F.S. ±1-digit

Communication Interface

■ RS485	
Comm. protocol	Modbus RTU/ASCII, Sync-Master, PLC ladderless
Connection type	RS-485, RS-422A
Application standard	EIA RS485 compliance with
Maximum connection	32 units (address: 01 to 99)
Synchronous method	Asynchronous
Comm. Method	Two-wire half duplex
Comm. effective range	≤ 800 m
Comm. speed	≤ 115,200 bps
Response time	5 to 99 ms (default: 20 ms)
Start bit	1 bit (fixed)
Data bit	8 bit (fixed)
Parity bit	None (default), Odd, Even
Stop bit	1 bit, 2 bit (default)
EEPROM life cycle	≈ 1,000,000 operations (Erase / Write)

• 1 character of ModBus RTU is fixed at 11 bit.

Dimensions

- Unit: mm, For the detailed drawings, follow the Autonics website.
- Below is based on TNS Series.

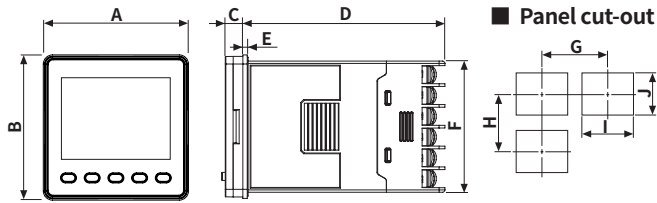

	Body						Panel cut-out			
	A	B	C	D	E	F	G	H	I	J
TNS	49	49	6	69	1.5	44.8	≥ 65	≥ 65	45 ^{+0.6} ₀	45 ^{+0.6} ₀
TNH	49	97	6	69	1.5	91.5	≥ 65	≥ 115	45 ^{+0.6} ₀	92 ^{+0.8} ₀
TNL	97	97	6	69	1.5	91.5	≥ 115	≥ 115	92 ^{+0.8} ₀	92 ^{+0.8} ₀

Bracket

TNS

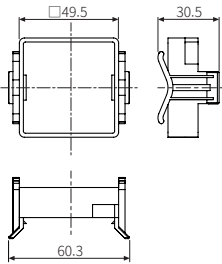

Other series

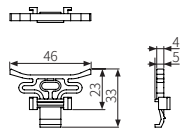

Unit Descriptions

- Below is based on TNL Series.
- The shape and function of each part may be different depending on the series, and it is possible to check the additional information in the user manual.

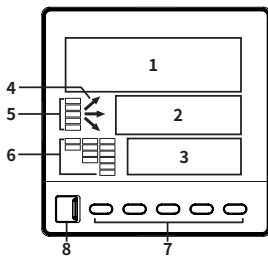

- PV display part (White)**
 - RUN mode: Displays PV (Present value) and unit.
 - Setting mode: Displays parameter name
- SV display part (Green)**
 - RUN mode: Displays SV (Setting value) and unit.
 - Setting mode: Displays parameter setting value.
- Operating value display part (Yellow)**
 - RUN mode: Displays selected value among MV (Manipulated output value), CT, TIME with unit.
- Temperature control indicator**
 - Fixed control: Relative PV value status display based on SV
PV > SV (↗), PV = SV (→), PV < SV (↘)
 - Program control: Displays temperature control status of up (↗), hold (→), down (↘).

5. Operation status indicator

Display	Name	Description
LOCK	Lock	Turns ON during key lock status.
PROG	Program	Turns ON during program control.
WAIT	Wait	Turns ON during waiting status.
HBA1/2	Heater break alarm	Turns ON when the heater break alarm output is ON.

6. Output status indicator

Display	Name	Description
OUT1/2	Control output	Turns ON when the control output is ON
AT	Auto tuning	Flashes during auto tuning every 1 sec
MAN	Manual control	Turns ON during manual control mode
STOP	Control output stop	Turns ON during control output stop mode
HOLD	Program control hold	Turns ON when program control is hold status
AL1 to 6	Alarm output	Turns ON when the alarm output is ON

7. Input key

Display	Name
[U]	User key
[M]	Mode key
[◀], [▼], [▲]	Setting value control key

8. PC loader port

For connecting communication converter (SCM-USP).

Sold Separately

- Communication converter: SCM Series
- Current transformer (CT)
- Terminal protection cover
- Front cover

Sold Separately: Front cover

- Unit: mm, For the detailed drawings, follow the Autonics website.

TNS: FSA-COVER

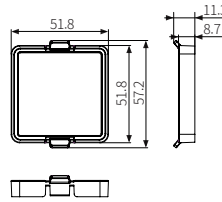

TNH: FHA-COVER

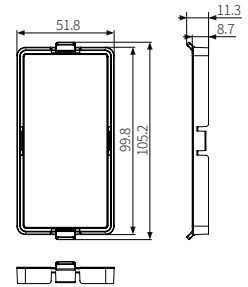

TNL: FLA-COVER

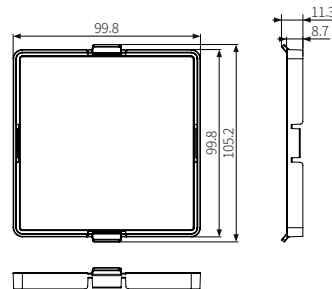

TNH 韩国 2 双自由度 PID 计时温度控制器 DOF 可编程序温控仪表 TNH-P 选型说明书 pdf
样本资料 TNL 使用手册 TNL-P 技术参数

[TNH ; TNH-P ; panel size: 48 x 96 mm](#)

[TNL ; TNL-P ; panel size: 96 x 96 mm](#)

[TNS ; TNS-P ; panel size: 48 x 48 mm](#)

TNH-P44SR-RS-006 ;	TNL-P46CC-RS-035	TNS-P42SS-NS-006
TNH-P44CR-RS-006	TNL-P44RR-RS-009	TNS-P42SS-NS-026
TNH-P44RR-RS-009	TNL-P44SR-RS-009	TNS-P42SS-NS-008
TNH-P44SS-RS-009	TNL-P44CR-RS-009	TNS-P42RR-NS-006
TNH-P44CC-RS-009	TNL-P46RR-RS-014	TNS-P42CC-NS-006
TNH-P44RR-RS-031	TNL-P44CR-RS-035	TNS-P42SR-NS-006
TNH-P44SS-RS-031	TNL-P46RR-RS-035	TNS-P42CR-NS-008
TNH-P44CC-RS-031	TNL-P46SS-RS-035	TNS-P42CC-NS-026
TNH-P44SR-RS-031	TNL-P44SS-RS-009	TNS-P42SR-NS-026
TNH-P44CR-RS-031	TNL-P44CC-RS-009	TNS-P42CR-NS-026
TNH-P44SR-RS-009	TNL-P46SS-RS-014	TNS-P42CR-NS-006
TNH-P44RR-RS-006	TNL-P46CC-RS-014	TNS-P42RR-NS-008
TNH-P44SS-RS-006	TNL-P46SR-RS-014	TNS-P42CC-NS-008
TNH-P44CC-RS-006	TNL-P46CR-RS-014	TNS-P42SR-NS-008
TNH-P44CR-RS-009	TNL-P44RR-RS-035	TNS-P42RR-NS-026
TNH-44RR-RS-006	TNL-P44SS-RS-035	TNS-P42SS-RS-006
TNH-44CR-RS-006	TNL-P44CC-RS-035	TNS-P42RR-RS-006
TNH-44RR-RS-009	TNL-P44SR-RS-035	TNS-P42CR-RS-006
TNH-44SS-RS-009	TNL-P46SR-RS-035	TNS-P42SR-RS-006
TNH-44CC-RS-009	TNL-P46CR-RS-035	TNS-P42CC-RS-006
TNH-44CR-RS-009	TNL-46CR-RS-035	TNS-42RR-NS-006
TNH-44CC-RS-031	TNL-46RR-RS-035	TNS-42SS-NS-006
TNH-44SR-RS-031	TNL-44RR-RS-009	TNS-42CC-NS-006
TNH-44SS-RS-031	TNL-44SS-RS-009	TNS-42SR-NS-006
TNH-44RR-RS-031	TNL-44CC-RS-009	TNS-42SS-NS-026
TNH-44SS-RS-006	TNL-46RR-RS-014	TNS-42CC-NS-026
TNH-44CC-RS-006	TNL-46SS-RS-035	TNS-42SR-NS-026
TNH-44SR-RS-006	TNL-46CC-RS-035	TNS-42CR-NS-026
TNH-44SR-RS-009	TNL-46SR-RS-035	TNS-42RR-RS-006
TNH-44CR-RS-031	TNL-44SR-RS-009	TNS-42RR-NS-026
TNL-44CC-RS-035	TNL-44CR-RS-009	TNS-42CR-NS-006
TNL-44SR-RS-035	TNL-46SS-RS-014	TNS-42RR-NS-008
TNL-44CR-RS-035	TNL-46CC-RS-014	TNS-42SS-NS-008
TNS-42CC-RS-006	TNL-46SR-RS-014	TNS-42CC-NS-008
TNS-42SR-RS-006	TNL-46CR-RS-014	TNS-42SR-NS-008
TNS-42CR-RS-006	TNL-44RR-RS-035	TNS-42CR-NS-008
	TNL-44SS-RS-035	TNS-42SS-RS-006

TN Series

Two-Degree-of-Freedom PID Temperature Controllers

User Manual MCT-TNU1-V1.1-EN

Thank you for purchasing an Autonics product.

This user manual contains information about the product and its proper use,
and should be kept in a place where it will be easy to access.

上海 18924626834

深圳 18926428394 微信

Autonics

Contents

Preface	7
Manual Guide	9
Common Symbols in the Manual	11
Safety Considerations	13
1. Two-Degree-of-Freedom PID Temperature Controllers	17
1.1. Features	17
1.2. Ordering Information	18
1.3. Software	19
1.4. Product Components and Sold Separately	19
1.4.1. Product Components	19
1.4.2. Sold Separately	19
1.5. Specifications	20
1.5.1. Input Specifications and Usage Range	22
1.5.2. Communication Interface	25
1.6. Unit Descriptions	26
1.7. Error	28
1.8. Dimensions	30
1.8.1. Body	30
1.8.2. Panel Cutout Dimension Drawing	30
1.8.3. Bracket	31
1.8.4. Front Cover	31
1.8.5. Terminal protection cover	32
1.8.6. Current Detector	33
1.9. Installation	35
1.10. Connection Diagram	36
(1) TNS	36
(2) TNH	36
(3) TNL	37
1.11. Crimp Terminal Specifications	38
1.12. Notes on Installation & Connection	38
1.12.1. Terminal	38

1.12.2. Sensor	38
1.12.3. Communication	39
1.13. Display Status When Power On	40
1.14. Mode Setting	41
2. Parameter	45
2.1. Operation parameter group: RUN	47
2.1.1. Control output RUN/STOP	49
2.1.2. Pause timer/pattern	50
2.1.3. Auto/Manual control	51
2.1.4. Heating/Cooling MV	51
2.1.5. Operation mode	52
2.1.6. 2-DOF PID control	52
2.2. Multi SV parameter group: SV	53
2.2.1. Multi SV	54
2.2.2. SV setting	54
2.3. PID control parameter group: PID	55
2.3.1. Auto-tuning RUN/STOP	57
2.3.2. Auto-tuning mode	58
2.3.3. PID control	59
2.3.4. Prevents over integration (Anti reset windup)	63
2.3.5. Alpha function	65
2.3.6. Zone PID	66
2.4. Input parameter group: IN	69
2.4.1. Input type	72
2.4.2. Temperature unit	72
2.4.3. Analog input	73
2.4.4. Input correct	75
2.4.5. Input digital filter	76
2.4.6. SV high/low-limit value	76
2.4.7. Analog transmission output	77
2.5. Pattern parameter group: PEN	79
2.5.1. Program time unit	82
2.5.2. Pattern start condition	82
2.5.3. Pattern standby action	83

2.5.4. Pattern number	85
2.5.5. Pattern repeat count	85
2.5.6. Pattern state after end	86
2.5.7. Pattern PID	87
2.5.8. Steps	88
2.5.9. Step SV and time	88
2.6. Control parameter group: <i>CNCL</i>	89
2.6.1. Control output operation	94
2.6.2. Control method	95
2.6.3. Sampling cycle	95
2.6.4. OUT 1/2 control output	95
2.6.5. OUT 1/2 SSR drive output method	96
2.6.6. OUT 1/2 current output range	97
2.6.7. Heating/Cooling control cycle	98
2.6.8. Heating-Cooling control dead band	99
2.6.9. Manual reset	103
2.6.10. Heating/Cooling hysteresis and offset	104
2.6.11. MV high/low-limit value	106
2.6.12. Timer	108
2.6.13. Ramp	110
2.7. PID group parameter group: <i>PI dG</i>	112
2.8. Event parameter group: <i>EVNE</i>	113
2.8.1. Event	117
2.8.2. Alarm output operation mode	118
2.8.3. Alarm output high/low-limit value	122
2.8.4. Alarm output hysteresis	124
2.8.5. Loop break alarm	125
2.8.6. Sensor break alarm	126
2.8.7. Heater break alarm	127
2.8.8. Notice pattern / step	129
2.8.9. Event output	129
2.9. Alarm output parameter group: <i>ALM</i>	130
2.9.1. Alarm output terminal and logic	131
2.9.2. Alarm output option	131

2.9.3. Alarm output contact	133
2.9.4. Alarm output ON/OFF delay time	134
2.10. Communication parameter group: $\Gamma \square M M$	135
2.10.1. Communication protocol	138
2.10.2. Communication setting	142
2.10.3. PLC address	143
2.10.4. PLC Register	143
2.10.5. PLC ladderless communication start time.....	145
2.10.6. PLC ladderless communication receive wait time	145
2.10.7. PLC Monitoring / Write parameter	146
2.10.8. PLC setting copy	149
2.11. Other parameter group: $E \text{ } \Gamma$	150
2.11.1. Power ON, initial SV	155
2.11.2. Alarm occur, control	155
2.11.3. Manual control, reference MV	156
2.11.4. Sensor error, MV	157
2.11.5. STOP, MV	158
2.11.6. STOP, Alarm output	158
2.11.7. Sensor error, high-limit alarm output	159
2.11.8. Soft start	160
2.11.9. Alarm latch output clear	161
2.11.10. Digital input terminal.....	162
2.11.11. Front shortcut key	164
2.11.12. User level	165
2.11.13. Password.....	165
2.11.14. Front key lock.....	166
2.11.15. Parameter reset	166
2.12. Monitoring parameter group: $M \square N$	167

Preface

Thank you for purchasing Autonics products.

Be sure to read and follow the **Safety Precautions** thoroughly before use.

This manual contains information about the product and how to use it properly, so keep it in a place where users can easily find it.

Manual Guide

- Use the product after fully reading the contents of the manual.
- The manual explains the product functions in detail and does not guarantee the contents other than the manual.
- Any or all of the manual may not be edited or copied without permission.
- The manual is not provided with the product.
- Download and use from our website (www.autonics.com).
- The contents of the manual are subject to change without prior notice according to the improvement of the product's performance, and upgrade notices are provided through our website.
- We put a lot of effort to make the contents of the manual a little easier and more accurate. Nevertheless, if you have any corrections or questions, please feel free to comment through our website.

Common Symbols in the Manual



Failure to follow instructions may result in serious injury or death.



Failure to follow instructions may result in injury or product damage.



Supplementary explanation of the function



Example of that function



Important information about the feature

Safety Considerations

- Observe all 'Safety Considerations' for safe and proper operation to avoid hazards.
- Symbol ! indicates caution due to special circumstances in which hazards may occur.



Failure to follow instructions may result in serious injury or death.



Failure to follow instructions may result in injury or product damage.



WARNING

1. Fail-safe device must be installed when using the unit with machinery that may cause serious injury or substantial economic loss.(e.g. nuclear power control, medical equipment, ships, vehicles, railways, aircraft, combustion apparatus, safety equipment, crime/disaster prevention devices, etc.)
Failure to follow this instruction may result in personal injury, economic loss or fire.
2. Do not use the unit in the place where flammable/explosive/corrosive gas, high humidity, direct sunlight, radiant heat, vibration, impact or salinity may be present.
Failure to follow this instruction may result in explosion or fire.
3. Install on a device panel to use.
Failure to follow this instruction may result in electric shock.
4. Do not connect, repair, or inspect the unit while connected to a power source.
Failure to follow this instruction may result in fire or electric shock.
5. Check 'Connections' before wiring.
Failure to follow this instruction may result in fire.
6. Do not disassemble or modify the unit.
Failure to follow this instruction may result in fire or electric shock.



CAUTION

1. When connecting the power input and relay output, use AWG 20 (0.50 mm²) cable or over, and tighten the terminal screw with a tightening torque of 0.74 to 0.90 N m. When connecting the sensor input and communication cable without dedicated cable, use AWG 28 to 16 cable and tighten the terminal screw with a tightening torque of 0.74 to 0.90 N m.
Failure to follow this instruction may result in fire or malfunction due to contact failure.
2. Use the unit within the rated specifications.
Failure to follow this instruction may result in fire or product damage
3. Use a dry cloth to clean the unit, and do not use water or organic solvent.
Failure to follow this instruction may result in fire or electric shock.
4. Keep the product away from metal chip, dust, and wire residue which flow into the unit.
Failure to follow this instruction may result in fire or product damage.



Cautions during Use

1. Follow instructions in 'Cautions during Use'. Otherwise, it may cause unexpected accidents.
2. Check the polarity of the terminals before wiring the temperature sensor. For RTD temperature sensor, wire it as 3-wire type, using cables in same thickness and length.
For thermocouple (TC) temperature sensor, use the designated compensation wire for extending wire.
3. Keep away from high voltage lines or power lines to prevent inductive noise. In case installing power line and input signal line closely, use line filter or varistor at power line and shielded wire at input signal line. Do not use near the equipment which generates strong magnetic force or high frequency noise.
4. Do not apply excessive power when connecting or disconnecting the connectors of the product.
5. Install a power switch or circuit breaker in the easily accessible place for supplying or disconnecting the power.
6. Do not use the unit for other purpose (e.g. voltmeter, ammeter), but temperature controller.
7. When changing the input sensor, turn off the power first before changing. After changing the input sensor, modify the value of the corresponding parameter.
8. Do not overlapping communication line and power line. Use twisted pair wire for communication line and connect ferrite bead at each end of line to reduce the effect of external noise.
9. Make a required space around the unit for radiation of heat. For accurate temperature measurement, warm up the unit over 20 min after turning on the power.

10. Make sure that power supply voltage reaches to the rated voltage within 2 sec after supplying power.
11. Do not wire to terminals which are not used.
12. This unit may be used in the following environments.
 - Indoors (in the environment condition rated in ‘Specifications’)
 - Altitude Max. 2,000 m
 - Pollution degree 2
 - Installation category II

The specifications, dimensions, etc are subject to change without notice for product improvement
Some models may be discontinued without notice.

For your safety, read and follow the considerations written in the instruction manual, other manuals
and Autonics website.

1. Two-Degree-of-Freedom PID Temperature Controllers

1.1. Features

- 2-DOF PID algorithm optimized for various control environments
- 50 ms high-speed sampling and $\pm 0.2\%$ display accuracy
- Program control and fixed control models available
 - Up to 10 patterns X 20 steps program setting (program control model)
 - Timer function for preset operation (fixed control model)
- Simultaneous heating/cooling and automatic/manual control function
- Control functions: Group PID, Zone PID, Anti Reset Windup (ARW)
- Control status monitoring of up to 10 events
- RS485 communication output model available
 - Communication protocols: Modbus RTU/ASCII, PLC ladderless, Sync-Master
 - Communication speed: up to 115,200bps
- Heater burnout alarm function (CT input)
- Parameter setting via PC
 - Comprehensive Device Management Software (DAQMaster) provided
 - Communication converter connection with front loader port (TNH, TNL only)
- Shortcut key setting with front user key button [U]
- Easy maintenance with detachable terminal blocks

1.2. Ordering Information

This is only for reference, the actual product does not support all combinations.
For selecting the specified model, follow the Autonics website .

Model Name: TN ① - ② ④ ③ ④ ⑤ - ⑥ S - ⑦

① Size

S: DIN W 48 × H 48 mm
H: DIN W 48 × H 96 mm
L: DIN W 96 × H 96 mm

② Control method

No mark: Fixed control
P: Program control

③ Alarm outputs

Number: number of alarm output

④ Control output 1

R: Relay
S: SSR drive
C: Current or SSR drive

⑤ Control output 2

R: Relay
S: SSR drive
C: Current or SSR drive

⑥ Communication

N: None
R: RS485

⑦ Option I/O

No.	Digital input	CT input	Transmission output
006	0	1	0
008	2	1	0
009	3	1	0
014	3	2	0
026	0	1	1
031	0	2	1
035	6	2	1

1.3. Software

Download the installation and manual from the program website.

DAQMaster

This is our dedicated device integrated management program that enables parameter setting, monitoring and data management.

1.4. Product Components and Sold Separately

1.4.1. Product Components

- Product
- Bracket
- Instruction manual



Before using the product, check that all of the above components are included. If it is damaged or any component is missing, contact our sales department or the place of purchase.

1.4.2. Sold Separately

- Communication converter: SCM-Series
- Front cover
- Terminal protection cover
- Current Detector (CT)



The product images of components and optional products may differ slightly from the actual product. For details on the above product, refer to the instruction manual of the product. Download the instruction manual for the product from our website (www.autonics.com).

1.5. Specifications

Power supply	100 - 240 VAC, 50/60 Hz \pm 10%
Power consumption	\leq 8 VA
Display type	11 segment, LCD type (operating value display part: 7 segment)
Sampling period	50 / 100 / 250 ms (parameter)
Input specification	Refer to 1.5.1, "Input Specifications and Usage Range"
Option input - CT	<ul style="list-style-type: none"> • 0.0-50.0 A (primary current measurement range) • CT ratio: 1/1,000 • Measurement accuracy: \pm5% F.S. \pm1digit
Option input - Digital	<ul style="list-style-type: none"> • Contact - ON: \leq 2 kΩ, OFF: \geq 90 kΩ • Non contact - residual voltage \leq 1.0 V, leakage current \leq 0.1 mA • Outflow current: \approx 0.5 mA per input
Control output	<ul style="list-style-type: none"> • Relay: 250 VAC 3 A 1a • SSR: 12 VDC \pm2 V, \leq 20 mA • Current: DC 0 - 20 mA or DC 4 - 20 mA selection (parameter), load resistance: \leq 500 Ω
Option output	<ul style="list-style-type: none"> • Alarm: 250 VAC 3 A 1a • Transmission: DC 4 - 20 mA (load resistance: \leq 500 Ω, output accuracy: \pm0.3% FS) • Communication: RS485
Control Type	<ul style="list-style-type: none"> • Type: ON/OFF, P, PI, PD, PID • Multi SV: \leq 4 SV • Group PID: \leq 8 groups • Zone PID: 4 zones • ARW (Anti Reset Windup) 50 to 200 %
Control	<ul style="list-style-type: none"> • Program: \leq 10 patterns • Step: \leq 200 steps (1 pattern: \leq 20 steps) • Setting type: Time setting
Hysteresis	<ul style="list-style-type: none"> • Thermocouple / RTD: 1 to 100 $^{\circ}$C/$^{\circ}$F (0.1 to 100.0 $^{\circ}$C/$^{\circ}$F) variable • Analog: 1 to 100 digit
Proportional band (P)	0.1 to 999.9 $^{\circ}$ C (0.1 to 999.9%)
Integral time (I)	0 to 9,999 seconds
Derivative time (D)	0 to 9,999 seconds
Control cycle (T)	<ul style="list-style-type: none"> • Relay/SSRP drive output: 0.1 to 120.0 sec • Current/SSR standard output: 1.0 to 120.0 sec.
Manual reset value	0.0 to 100.0%
Dielectric strength	Between the charging part and the case : 3,000VAC to 50/60Hz for 1 minute

Vibration	0.75 mm amplitude at frequency of 5 to 55 Hz (for 1 min) in each X,Y, Z direction for 2 hours
Relay life cycle	<ul style="list-style-type: none"> • Mechanical - OUT1/2: ≥ 5,000,000 operations, AL1/2/3/4/5/6: ≥ 20,000,000 operations • Electrical - OUT1/2: ≥ 200,000 operations, AL1/2/3/4/5/6: ≥ 100,000 operations
Insulation resistance	≥ 100 MΩ (500 VDC megger)
Insulation type	Double or reinforced insulation (symbol: □, dielectric strength between the measuring input part and the power part: 3 kV)
Noise immunity	±2 kV square shaped noise by noise simulator (pulse width: 1 μs) R-phase, S-phase
Memory retention	≈ 10 years (non-volatile semiconductor memory type)
Ambient temperature	-10 to 50 °C, storage: -20 to 60 °C (no freezing or condensation)
Ambient humidity	35 to 85%RH
Protection structure	IP65 (front part, IEC specifications)
Loader port	• TNS: Top, • TNH, TNL: Front
Accessories	Bracket
Unit weight (packaged)	<ul style="list-style-type: none"> • TNS: ≈ 128 g (≈ 156 g) • TNH: ≈ 184 g (≈ 286 g) • TNL: ≈ 301 g (≈ 443 g)
Approval	CE, cULus, KC

1.5.1. Input Specifications and Usage Range

When using the first decimal place notation, the setting range of some parameters is limited.

Thermocouple

Input spec	Decimal point	Display method	Use range (°C)	Use range (°F)
K (CA)	1	Ⓚ Ⓒ R.H	-200 to 1,350	-328 to 2,463
	0.1	Ⓚ Ⓒ R.L	-199.9 to 999.9	-199.9 to 999.9
J (IC)	1	Ⓜ Ⓘ Ⓒ.H	-200 to 800	-328 to 1,472
	0.1	Ⓜ Ⓘ Ⓒ.L	-199.9 to 800.0	-199.9 to 999.9
E (CR)	1	Ⓔ Ⓒ R.H	-200 to 800	-328 to 1,472
	0.1	Ⓔ Ⓒ R.L	-199.9 to 800.0	-199.9 to 999.9
T (CC)	1	Ⓔ Ⓒ Ⓒ.H	-200 to 400	-328 to 752
	0.1	Ⓔ Ⓒ Ⓒ.L	-199.9 to 400.0	-199.9 to 752.0
B (PR)	1	Ⓑ Ⓟ R	0 to 1,800	32 to 3,272
R (PR)	1	Ⓡ Ⓟ R	0 to 1,750	32 to 3,182
S (PR)	1	Ⓢ Ⓟ R	0 to 1,750	32 to 3,182
N (NN)	1	Ⓝ Ⓝ Ⓝ	-200 to 1,300	-328 to 2,372
C (TT) ⁰¹⁾	1	Ⓒ Ⓣ Ⓣ	0 to 2,300	32 to 4,172
G (TT) ⁰²⁾	1	Ⓒ Ⓣ Ⓣ	0 to 2,300	32 to 4,172
L (IC)	1	Ⓕ Ⓘ Ⓒ.H	-200 to 900	-328 to 1,652
	0.1	Ⓕ Ⓘ Ⓒ.L	-199.9 to 900.0	-199.9 to 999.9
U (CC)	1	Ⓖ Ⓒ Ⓒ.H	-200 to 400	-328 to 752
	0.1	Ⓖ Ⓒ Ⓒ.L	-199.9 to 400.0	-199.9 to 752.0
Platinel II	1	Ⓟ Ⓕ Ⓘ Ⓘ	0 to 1,390	32 to 2,534

Input spec	Decimal point	Display method	Use range (°C)	Use range (°F)
L(RUS)	1	L R.H	-200 to 800	-328 to 1472
	0.1	L R.	-199.9 to 800.0	-199.9 to 999.9

Resistance thermometer (RTD)

Input spec	Decimal point	Display method	Use range (°C)	Use range (°F)
Cu50 Ω	0.1	C U 5	-199.9 to 200.0	-199.9 to 392.0
Cu100 Ω	0.1	C U 10	-199.9 to 200.0	-199.9 to 392.0
JPt100 Ω	1	J P t.H	-200 to 650	-328 to 1,202
	0.1	J P t.L	-199.9 to 650.0	-199.9 to 999.9
DPT50 Ω	0.1	d P t 5	-199.9 to 600.0	-199.9 to 999.9
DPT100 Ω	1	d P t.H	-200 to 650	-328 to 1,202
	0.1	d P t.L	-199.9 to 650.0	-199.9 to 999.9
Nickel120 Ω	1	N I 12	-80 to 200	-112 to 392

Analog

Input spec	Decimal point	Display method	Use range
0 to 10 V	Depending on decimal point setting	R V 1	0 to 1,000
0 to 5 V		R V 2	0 to 5,000
1 to 5 V		R V 3	1,000 to 5,000
0 to 100 mV		R M V 1	0 to 1,000
0 to 20 mA		R M A 1	0 to 2,000
4 to 20 mA		R M A 2	400 to 2,000

- Allowable line resistance of a resistance thermometer (RTD) per line: ≤ 5 Ω

01) C(TT) is the same temperature sensor as the previous W5(TT)

02) G(TT) is the same temperature sensor as the previous W(TT)

1.5.1.1. Display Accuracy

Thermocouple, RTD

Room temperature section (23°C ±5 °C)

(±0.2% of PV or ±1 °C, whichever is greater) ±1-digit

- Thermocouples K, J, T, N, E below -100°C and L, U, PLII, RTD Cu50 Ω, DPT50 Ω:
(±0.3% of PV or ±2 °C, whichever is greater) ±1-digit
- Below 200 °C for thermocouples C, G and R, S:
(±0.3% of PV or ±3 °C, whichever is greater) ±1-digit
- No accuracy regulation for thermocouple B below 400°C

Sections other than room temperature

(±0.5% of PV or ±2 °C, whichever is greater) ±1-digit

- RTD Cu50 Ω, DPT50 Ω:
(±0.5% of PV or ±3 °C, whichever is greater) ±1-digit
- Thermocouples R, S, B, C, G:
(±0.5% of PV or ±5 °C, whichever is greater) ±1-digit
- Other sensor: ≤ ±5 °C (≤-100 °C)

Analog

Room temperature range (23°C ±5°C)

(±0.2% of FS) ± 1-digit

Sections other than room temperature

(±0.5% of FS) ± 1-digit

1.5.2. Communication Interface

RS485

Comm. protocol	Modbus RTU/ASCII, Sync-Master, PLC ladderless
Connection type	RS-485, RS-422A
Application standard	EIA RS485 compliance with
Maximum connection	32 units (address: 01 to 99)
Synchronous method	Asynchronous
Comm. Method	Two-wire half duplex
Comm. effective range	≤ 800 m
Comm. speed	≤ 115,200 bps
Response time	5 to 99 ms (default: 20 ms)
Start bit	1 bit (fixed)
Data bit	8 bit (fixed)
Parity bit	None (default), Odd, Even
Stop bit	1 bit, 2 bit (default)
EEPROM life cycle	≈ 1,000,000 operations (Erase / Write)



1 Character of ModBus RTU is fixed at 11 bit.



For communication converters, we recommend using our products. For communication cable, use twisted pair line suitable for RS485 communication.

1.6. Unit Descriptions

- Based on the TNL series.
- The shape and function of each part may be different depending on the series, and it is possible to check the additional information in the user manual.

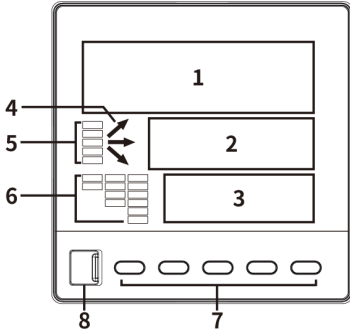

1. PV display part (white)

- RUN mode: Displays PV (Present value) and unit.
- Setting mode: Displays parameter name

2. SV display part (green)

- RUN mode: Displays SV (Setting value) and unit.
- Setting mode: Displays parameter setting value.

3. Operating value display part (yellow)

- TNH, TNL series only, depending on model and setting
- Driving mode:
MV1: OUT1 MV
MV2: OUT2 MV
P/S: In-progress pattern, step display
TM1: Remaining timer time / Elapsed program time
TM2: Remaining step time and standby time
CT1: CT1 current value
CT2: CT2 current value

4. Temperature Control Graph indicator

- TNH, TNL series only

- In case of fixed control: SV standard PV value status display
 $PV > SV$ (↗), $PV = SV$ (→), $PV < SV$ (↘)
- Program control: Display of rise (↗), holding (→), and falling (↘) status of temperature control

5. Operation status indicator

Display	Name	Content
LOCK	Lock	Turns ON during key lock status.
PROG	Program	Turns ON during program control.
WAIT	Standby	Turns ON during waiting status.
HBA1/2	Heater break alarm	Turns ON when the heater break alarm output is ON.

6. Output status indicator

Display	Name	Content
OUT1/2	Control output	Turns ON when the control output is ON
AT	Auto tuning	Flashes during auto tuning every 1 sec
MAN	Manual control	Turns ON during manual control mode
STOP	Control output stop	Turns ON during control output stop mode
HOLD	Program control hold	Turns ON when program control is hold status
AL1 to 6	Alarm output	Turns ON when the alarm output is ON

7. Input key

Display	Name
[U]	User key
[M]	Mode key
[◀],[▼],[▲]	Set value operation keys

8. PC Loader port

Communication converter (SCM-USP) connection

1.7. Error

OPEN

- **Input: Temperature sensor**

Description: Flashes at 0.5 sec interval when input sensor is disconnected or sensor is not connected.

Output: 'Sensor error, MV' parameter setting value

Troubleshooting: Released when the input sensor normally connected. Check input sensor status.

- **Input: Analog**

Description: Flashes at 0.5 sec interval when input is over F.S. $\pm 10\%$.

Output: 'Sensor error, MV' parameter setting value

Troubleshooting: Released when the input value returns within the FS range. Check the analog input status.

HHHH

- **Input: Temperature sensor**

Description: Flashes at 0.5 sec interval if the input value is above the input range.

Output: Heating 0%, Cooling 100%

Troubleshooting: When input is within the rated input range, this display disappears.

- **Input: Analog**

Description: Flashes at 0.5 sec interval if the input value is over 5 to 10% of high limit or low limit value.

Output: Normal output

Troubleshooting: When input is within the rated input range, this display disappears.

LLLL

- **Input: Temperature sensor**

Description: Flashes at 0.5 sec. interval if the input value is below the input range.

Output: Heating 100%, Cooling 0%

Troubleshooting: When input is within the rated input range, this display disappears.

- **Input: Analog**

Description: Flashes at 0.5 sec interval if the input value is over 5 to 10% of low limit or high limit value.

Output: Normal output

Troubleshooting: When input is within the rated input range, this display disappears.

ERR

Description: Flashes at 0.5 sec interval if there is error for setting and it returns to the error-before screen.

Troubleshooting: Check setting method.

TMR.E

Description: Flashes twice at the start of operation and the control output stops if the timer operation related parameter setting is not completed.

Troubleshooting : Set the timer operation related parameters.

PTN.E

Description: Flashes twice at the start of operation and the control output stops if the program operation related parameter setting is not completed.

Troubleshooting : Set the program operation related parameters.

1.8. Dimensions

- Unit: mm, For the detailed drawings, follow the Autonics website.
- Based on the TNS series.

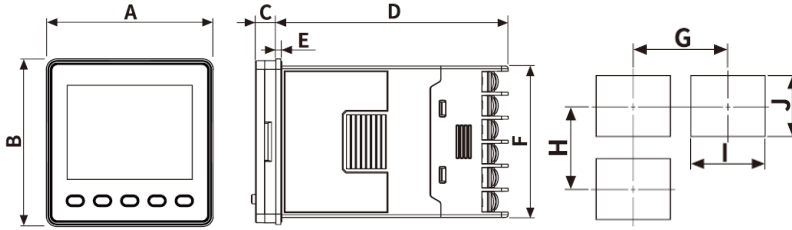

1.8.1. Body

	A	B	C	D	E	F
TNS	49	49	6	69	1.5	44.8
TNH	49	97	6	69	1.5	91.5
TNL	97	97	6	69	1.5	91.5

1.8.2. Panel Cutout Dimension Drawing

	G	H	I	J
TNS	≥ 65	≥ 65	$45^{+0.6}_t \text{ to } 0 \text{ to}$	$45^{+0.6}_t \text{ to } 0 \text{ to}$
TNH	≥ 65	≥ 115	$45^{+0.6}_t \text{ to } 0 \text{ to}$	$92^{+0.8}_t \text{ to } 0 \text{ to}$
TNL	≥ 115	≥ 115	$92^{+0.8}_t \text{ to } 0 \text{ to}$	$92^{+0.8}_t \text{ to } 0 \text{ to}$

1.8.3. Bracket

TNS

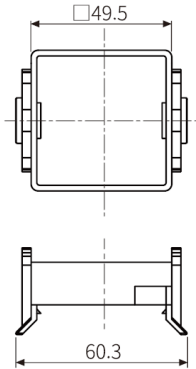

Other series

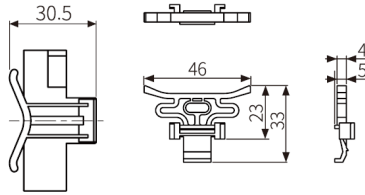

1.8.4. Front Cover

■ TNS: FSA-COVER

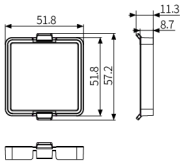

■ TNH: FHA-COVER

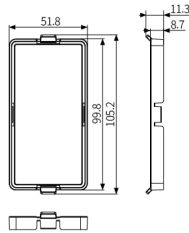

■ TNL: FLA-COVER

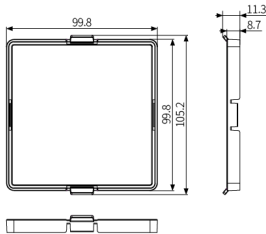

1.8.5. Terminal protection cover

■ RSA-COVER: DIN W48 × H48

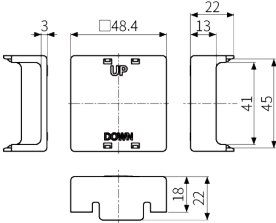

■ RHA-COVER: DIN W48 × H96

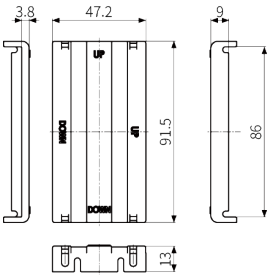

■ RLA-COVER: DIN W96 × H96

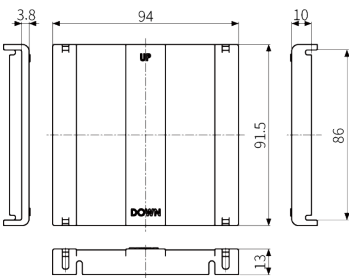

1.8.6. Current Detector

■ CSTC-E80LN

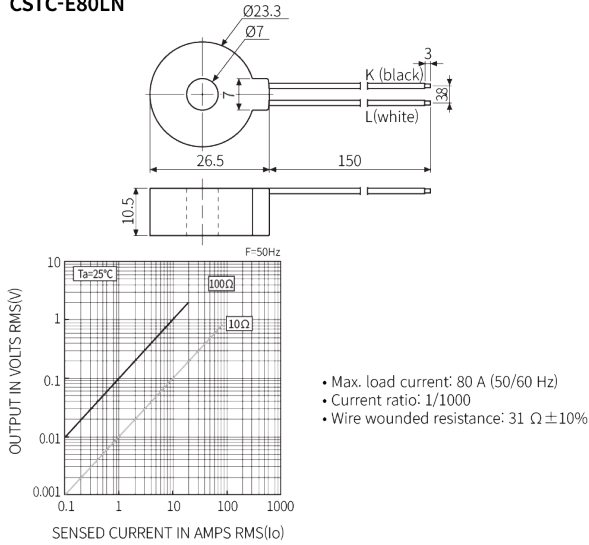

■ CSTC-E200LN

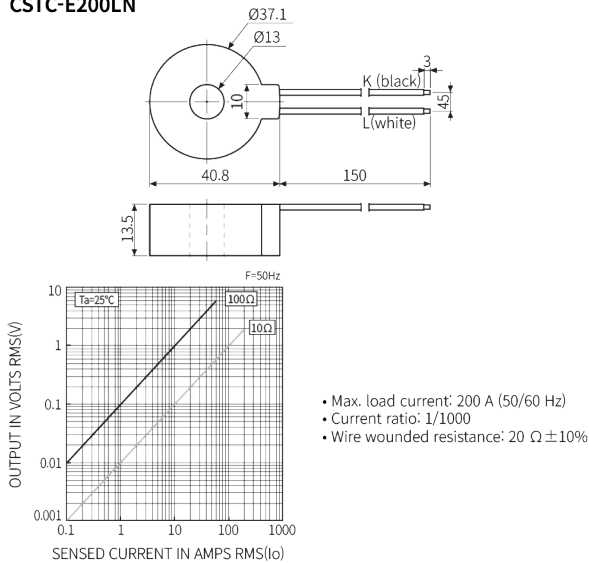

■ CSTS-E80PP

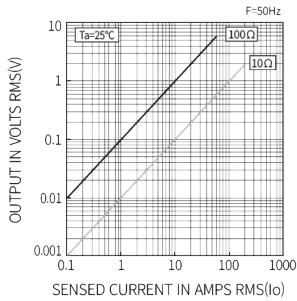
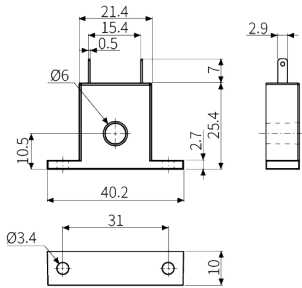

- Max. load current: 80 A (50/60 Hz)
- Current ratio: 1/1000
- Wire wounded resistance: $31\ \Omega \pm 10\%$

1.9. Installation

After mounting the product on the panel using the bracket, use a flat head driver to push it in the direction of the arrow.

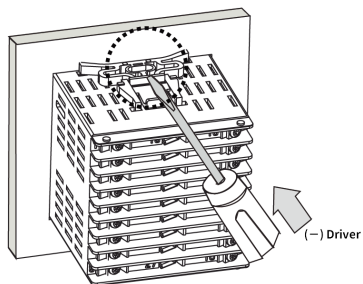

1.10. Connection Diagram

(1) TNS

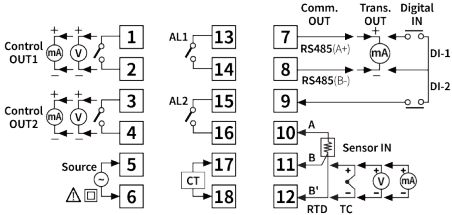

(2) TNH

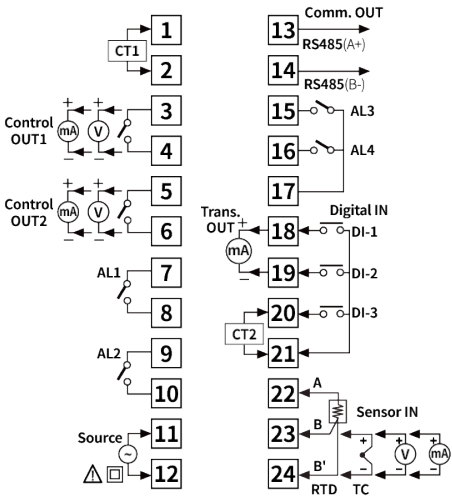

(3) TNL

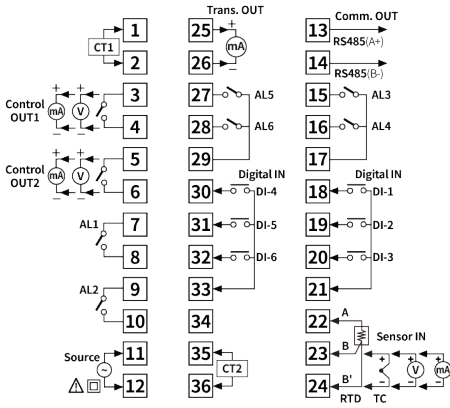

1.11. Crimp Terminal Specifications

Unit: mm, use the following shape for crimp terminal.

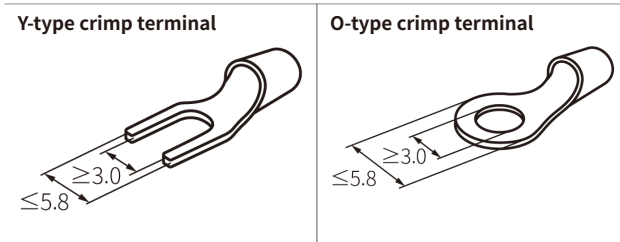

1.12. Notes on Installation & Connection

1.12.1. Terminal

- The product may be damaged if the input terminal and output terminal are connected incorrectly.
- Connect an SSR or load with the capacity appropriate for the rating to the output terminal.
- Pay attention to the + and - direction of the power terminal.

1.12.2. Sensor

- Use a sensor supported by the product.
- Select the position of the load and sensor to suit the user environment, and fix the sensor firmly to the input connector.
- Pay attention to the polarity when connecting the temperature sensor and analog input.
- Make sure that the input sensor connector is not connected in a different direction.
- For the compensation wire of the thermocouple sensor, be sure to use the wire with the same specification as the selected sensor. Using compensating wires of different specifications and material will result in inaccurate measurements.
- There are two types of compensating wire: general type and high-end type, so selection one and use it. In the case of the general type, the price is low, but the accuracy is low.
- Do not bundle the wiring sensor line and AC power line together.

1.12.3. Communication

- Pay attention to the direction of A and B terminal of the communication terminal.
- Connect the communication line using a communication converter suitable for your environment.
- Be sure to use twisted pair lines for communication lines and do not exceed 800 m max.
- Do not bundle communication lines and AC power lines together.
- Refer to 2.10, “Communication parameter group: $\Gamma_{\square MM}$ ” for details on communication settings.

1.13. Display Status When Power On

If no error occurs in the product after turning on the power, the entire front display part lights up for about 1 second. After that, the model name and input specifications are displayed by blinking twice in sequence (every 0.5 sec), and then enters the RUN mode.

- Model Name: TNSP-42RR-RS-006
- Input specification: K(CA) (decimal point: 1)



Display part	1. Model name	2. Model name	3. Input Specifications	4. RUN mode
PV	TNSP	RS	TYPE	OPEN
SV	42RR	006	KCA.H	0

1.14. Mode Setting

RUN mode → Enter → Mode setting → Return → RUN mode

Input password

Set a password to prevent misconfiguration.

For more information, refer to 2.11.13, “Password”.

- Enter: If a password has been set, enter the password before entering each mode. When the password matches, it enters the mode.
- Re-enter password: If the password does not match, press any key among ◀, ▲, ▼
- Return: **M** key

MV Settings

- Enter: In case of TNH/TNL, in manual control, press any key among ◀, ▲, ▼
- Set
Shift digits: ◀ key
Change values: ▲, ▼ key
- Save and return: **M** or when there is no key input for more than 3 seconds, save the set value and return to RUN mode.



For TNS and TNH/TNL, it can be set in operating parameter group 1-4/5 Heating/Cooling MV.

SV Settings

- Enter: In case of auto control, press any key among ◀, ▲, ▼
- Set
Shift digits: ◀ key
Change values: ▲, ▼ key
- Save and return: **M** or when there is no key input for more than 3 seconds, save the set value and return to RUN mode.

Operating value display part setting



In case of TNH/TNL, select the type of operation value to be displayed on the operation value display part in RUN mode.

- Enter: **M** + ▲ keys
- Setting: Each time **M** + ▲ keys are pressed, the operation value display part changes

- Displayed on:
MV1: OUT1 MV
MV2: OUT2 MV
P/S: In-progress pattern, step display
TM1: Remaining timer time / Elapsed program time
TM2: Remaining step time and standby time
CT1: CT1 current value
CT2: CT2 current value
- Save and return: Automatically save and return to RUN mode

Control output Run/Stop

Refer to 2.1.1.1, “Control output RUN/STOP” for refer related to control output run/stop setting.

- Enter:  +  keys 3 seconds
- Return: Automatically returns to RUN mode

Shortcuts

It operates according to the setting value of 11-17 to 19 Shortcut function of Other parameter group.
Refer to 2.11.11, “Front shortcut key” for more information on shortcut settings.



- Shortcut key  +  keys 2 seconds
- Shortcut key  +  keys 2 seconds
- Shortcut key  +  keys 2 seconds

Front Key Lock

Lock the front key to prevent misuse.

When you enable key lock mode, all settings except for communication settings are locked.



It works the same in other parameter group 11-22 Front key lock.

- Enter:  +  keys 3 seconds
- Return:  +  keys 3 seconds

Parameter reset

If you selection YES after entering, all parameters are initialized.

It works the same in 11-23 Parameter reset of other parameter group.

- Enter:  +  +  keys 5 seconds
- Return: Automatic return after executing the reset process

Parameter setting

Refer to 2, Parameter for details of each parameter group.

Some parameters are enabled/disabled depending on the setting of the model or other parameters.

- Enter: **M** key 2 seconds
- Move and set
 - Move between parameter groups: **▲**, **▼** key
 - Enter within parameter group: **M** key
 - Move between parameters: **▲**, **▼** key
 - Enter parameter setting: **M** key
 - Selection setting value: **▲**, **▼** key / Move set value digits: **◀** key / Change setting value: **▲**, **▼** key
 - Save setting value: **M** key
- Return: **◀** key 2 seconds

Example: When setting the temperature unit of the input parameter group to change °C → °F

1. In RUN mode, press **M** key for 2 seconds to enter parameter setting.
2. The first parameter group is either a user parameter group or operation parameter group.
Press **▲**, **▼** to move to the input parameter group. Press **M** to enter the parameter group.
3. Press **▲**, **▼** to move to the temperature unit parameter.
4. Press **M** key to enter the setting mode and selection the desired setting value with the **▲**, **▼** keys.

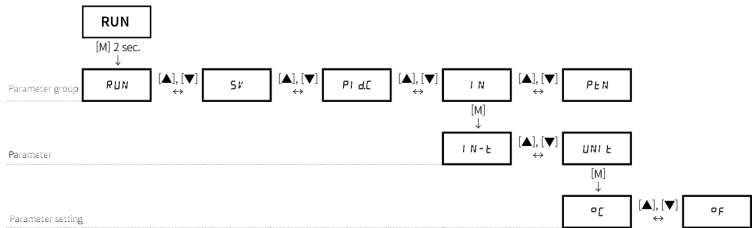

User parameter group

You can directly configure the parameters used by the user as a user parameter group in DAQMaster.

Up to 30 parameters can be set.

Refer to the DAQMaster User manual for more details.

- Enter: (after setting DAQMaster user parameter group) **M** 2 seconds
- Return: **◀** key 2 seconds

2. Parameter

No.	Parameter group	Display	Link
1	Operation parameter group	<i>RUN</i>	2.1, "Operation parameter group: <i>RUN</i> "
2	Multi SV parameter group	<i>SV</i>	2.2, "Multi SV parameter group: <i>SV</i> "
3	PID control parameter group	<i>PI dC</i>	2.3, "PID control parameter group: <i>PI dC</i> "
4	Input parameter group	<i>IN</i>	2.4, "Input parameter group: <i>IN</i> "
5	Pattern parameter group	<i>PN</i>	2.5, "Pattern parameter group: <i>PN</i> "
6	Control parameter group	<i>CNEL</i>	2.6, "Control parameter group: <i>CNEL</i> "
7	PID group parameter group	<i>PI dG</i>	2.7, "PID group parameter group: <i>PI dG</i> "
8	Event parameter group	<i>EVNE</i>	2.8, "Event parameter group: <i>EVNE</i> "
9	Alarm output parameter group	<i>RLM</i>	2.9, "Alarm output parameter group: <i>RLM</i> "
10	Comm. parameter group	<i>COMM</i>	2.10, "Communication parameter group: <i>COMM</i> "
11	Other parameter group	<i>ELC</i>	2.11, "Other parameter group: <i>ELC</i> "
12	Monitoring parameter group	<i>MON</i>	2.12, "Monitoring parameter group: <i>MON</i> "



- Some parameters are enabled/disabled depending on the setting of the model or other parameters. Please refer to the description of each description.
- For entering parameter, refer to 1.14, “Mode Setting”.
- When user parameter group is set, the user parameter group displays as the first of parameter groups.
- When 11-16 **U** key enter parameter group is set, it is available to enter by press **U** key to enter directly.
- When 11-20 User level: STND, * mark parameters of the each parameter group table only display.

2.1. Operation parameter group: RUN

Description		Display	Default	Set range	Unit	Display condition	
1-1	Control output RUN/STOP	R - S	STOP	RUN: Control output RUN STOP: Control output STOP	-	-	
1-2	Pause timer/pattern	t - S	CONT	[Fixed control model] CONT: Unpause the timer. PAUS: Pause the timer.	-	1-1 Control output RUN/STOP: RUN	6-20 Timer mode: Except OFF
				[Program control model] CONT: Operates as the set pattern. PAUS: During control output operation, the current SV is fixed and the control is maintained. Temporarily pauses the operation time (step, pattern) of the control section.			1-6 Operation mode: PROG
1-3	Auto/Manual control	AUMM	AUTO	AUTO: Control with the MV calculated by PID control with the preset SV as the target MAN: Controlled by the MV set arbitrarily by the user	-	-	

Description		Display	Default	Set range	Unit	Display condition	
1-4	Heating MV	H-MV	-	0.0 to 100.0	%	1-3 Auto/Manual control: MAN	6-1 Control output operation : HEAT, H-C
1-5	Cooling MV	C-MV	-	0.0 to 100.0	%		6-1 Control output operation : COOL, H-C
1-6	Operation mode	Mode	PRG	[Program control model] FIX: Normal (fixed) control PROG: Program control	-	-	
1-7	2-DOF PID control	2dof	ON	ON: 2-DOF PID control OFF: PID control	-	6-2 Control method: PID	

2.1.1. Control output RUN/STOP

In RUN mode, the user can set RUN/STOP of control output.

Description		Display	Default	Set range	Unit	Display condition
1-1	Control output RUN/STOP	R - S	STOP	RUN: Control output RUN STOP: Control output STOP	-	-

- When STOP is set, the indicator 'STOP' is displayed on the SV display.
- Auxiliary output is not affected by the corresponding parameter setting.
- 11-1 Power ON, initial SV has priority.
- 11-6 STOP, MV has priority.
- 11-5 Sensor error, MV has priority.
- [Program control model] When changing Fixed → Program control, it runs control output. When changing Program → Fixed control, it stops control output.



Control output RUN/STOP

. 1-1 Control output RUN/STOP

. 11-13 to 15 Digital input terminal: STOP is set and input the dedicated terminal (digital input has priority.)

. Press ▼ + ▲ keys 3 seconds in RUN mode

2.1.2. Pause timer/pattern

After temporarily stopping (30 minutes) the timer or pattern operation during control output operation, the control output is converted to 'STOP'.

Description		Display	Default	Set range	Unit	Display condition	
1-2	Pause timer/pattern	t - 5	CONT	[Fixed control model] CONT: Unpause the timer. PAUS: Pause the timer.	-	1-1 Control output RUN/STO P: RUN	6-20 Timer mode: Except OFF
				[Program control model] CONT: Operates as the set pattern. PAUS: During control output operation, the current SV is fixed and the control is maintained. Temporarily pauses the operation time (step, pattern) of the control section.			1-6 Operation mode: PROG

- During pause, the indicator 'HOLD' flashes every 1 second.
- Resets to CONT when power is re-applied.
- If the pause is maintained for more than 30 minutes, the control operation stops.

2.1.3. Auto/Manual control

Description		Display	Default	Set range	Unit	Display condition	
1-3	Auto/Manual control	Auto/Manual	Auto	AUTO: Control with the MV calculated by PID control with the preset SV as the target MAN: Controlled by the MV set arbitrarily by the user (disable parameter set ⁽⁰¹⁾)	-	-	

01) 11-22 Front key lock is available to set. The other parameters are available only to check.

- During control output STOP, Auto/Manual control convert is available.
- 11-5. Sensor error, MV has priority. Manual control convert is available.

Auto/Manual control setting



- 1-3 Auto/Manual control
- 11-13 to 15 Digital input terminal: A/M is set and input the dedicated terminal (digital input has priority.)
- 11-17 to 19 Shortcut function: A/M is set and press the dedicated keys in RUN mode

2.1.4. Heating/Cooling MV

Description		Display	Default	Set range	Unit	Display condition	
1-4	Heating MV	H - MV	-	0.0 to 100.0	%	1-3 Auto/Manual control: MAN	6-1 Control output operation : HEAT, H-C
1-5	Cooling MV	C - MV	-	0.0 to 100.0	%		6-1 Control output operation : COOL, H-C

- 11-13 to 15 Digital input terminal: A/M and terminal input is set as AUTO control status, MV setting is not available and only checking is available. In case of MANUAL status, MV setting and checking are available.
- When parameter masking is set, 12-1/2 Heating/Cooling MV Monitoring and setting is not available.
- In case of Program and Timer control, it does not applied to control output status. It is available to set at control output STOP status.

Heating/Cooling MV setting

- TNS/TNH/TNL Series
1-4/5 Heating/Cooling MV
- TNH/TNL Series
In RUN mode, press **M** + **▲** keys and MV is set at MV display setting mode.
MV1: OUT1 control output value, MV2: OUT2 control output value

2.1.5. Operation mode

Description		Display	Default	Set range	Unit	Display condition
1-6	Operation mode	ModE	PRG	[Program control model] FIX: Normal (fixed) control PROG: Program control	-	-

2.1.6. 2-DOF PID control

2-DOF PID control can be set to optimize response to set point change and to obtain appropriate response to disturbance.

Description		Display	Default	Set range	Unit	Display condition
1-7	2-DOF PID control	2dof	ON	ON: 2-DOF PID control OFF: PID control	-	6-2 Control method: PID

2.2. Multi SV parameter group: 5V

Description		Display	Default	Set range	Unit	Display condition
2-1	Multi SV [*]	5V.N	5V.0	SV.0, SV.1, SV.2, SV.3	-	-
2-2	SV 0 setting [*]	5V.0	-	L-SV to H-SV	°C/°F/ -	-
2-3	SV 1 setting [*]	5V.1				
2-4	SV 2 setting [*]	5V.2				
2-5	SV 3 setting [*]	5V.3				

2.2.1. Multi SV

Up to 4 set values (SVs) to be controlled can be set independently.

Description	Display	Default	Set range	Unit	Display condition	
2-1	Multi SV	SV.N	SV.0	SV.0, SV.1, SV.2, SV.3	-	-

- When using the Multi SV function, the PID value for the set temperature of SV0 to SV3 is the same.



Multi SV selection

- 2-1 Multi SV
- 11-13 to 15 Digital input terminal: MT.SV is set and input the dedicated terminal combination (digital input has priority.)

2.2.2. SV setting

Description	Display	Default	Set range	Unit	Display condition
2-2	SV 0 setting	SV.0	L-SV to H-SV	°C/°F/ -	-
2-3	SV 1 setting	SV.1			
2-4	SV 2 setting	SV.2			
2-5	SV 3 setting	SV.3			

2.3. PID control parameter group: $Pi d.C$

This group displays only when 6-2 Control method: PID.

Description		Display	Default	Set range	Unit	Display condition	
3-1	Auto-tuning RUN/STOP	Rt	OFF	ON: Auto-tuning RUN OFF: Auto-tuning STOP	-	1-6 Operation mode: FIX	6-2 Control method: PID
3-2	Auto-tuning mode	$Rt.t$	$TUN1$	TUN1: Auto-tuning RUN based on SV TUN2: Auto-tuning RUN based on 70% of SV	-		
3-3	Heating proportional band	$H-P$	0100	000.1 to 999.9	$^{\circ}C/^{\circ}F/-$	6-1 Control output operation: HEAT, H-C	6-2 Control method: PID
3-4	Heating integral time	$H-I$	0240	0000 (OFF) to 9999	Sec		
3-5	Heating derivative time	$H-d$	0049	0000 (OFF) to 9999	Sec		
3-6	Cooling proportional band	$C-P$	0100	000.1 to 999.9	$^{\circ}C/^{\circ}F/-$	6-1 Control output operation: COOL, H-C	
3-7	Cooling integral time	$C-I$	0240	0000 (OFF) to 9999	Sec		
3-8	Cooling derivative time	$C-d$	0049	0000 (OFF) to 9999	Sec		

Description		Display	Default	Set range	Unit	Display condition	
3-9	Prevents over integration	<i>RRWb</i>	<i>OFF</i>	OFF, 50 to 200	%	1-7 2-DOF PID control: OFF	6-2 Control method: PID
3-10	Alpha function	<i>ALFA</i>	<i>50</i>	0 to 100 0: Shorter time to reach SV 100: Extend time to reach SV	%	1-7 2-DOF PID control: ON	
3-11	Zone PID	<i>ZONE</i>	<i>OFF</i>	ON: Zone PID OFF: No Zone PID, basic SV and PID applied	-	6-2 Control method: PID	
3-12	Reference point low-limit value	<i>RP-L</i>	Min. value + 25% of F.S.	Input min. value to RP-C - 1 digit (RP-L < RP-C < RP-H)	°C/°F/ -	3-11 Zone PID: ON	6-2 Control method: PID
3-13	Reference point center value	<i>RP-C</i>	Min. value + 50% of F.S.	RP-L + 1 digit to RP-H - 1 digit (RP-L < RP-C < RP-H)			
3-14	Reference point high-limit value	<i>RP-H</i>	Min. value + 75% of F.S.	RP-C + 1 digit to input max. value (RP-L < RP-C < RP-H)			
3-15	Reference point hysteresis	<i>ZHYS</i>	<i>2</i>	1 to 100	°C/°F/ -	3-11 Zone PID: ON 6-2 Control method: PID	4-1 Input type: Temp. H, Analog
			<i>2.0</i>	0.1 to 100.0			4-1 Input type: Temp. L

2.3.1. Auto-tuning RUN/STOP

PID control auto-tuning measures the thermal characteristics and thermal response speed of various control objects in the temperature controller itself.

Calculating the PID value required for ideal control, and applying that value, it controls fast response characteristics and high precision.

Description		Display	Default	Set range	Unit	Display condition	
3-1	Auto-tuning RUN/STOP	AT	OFF	ON: Auto-tuning RUN OFF: Auto-tuning STOP	-	1-6 Operation mode: FIX	6-2 Control method: PID

- During Auto-tuning operation, the indicator 'AT' flashes every 1 second. All parameters are available to check.
- During Auto-tuning operation, it is able to stop by setting as 1-1 Control output RUN/STOP: STOP or 3-1 Auto-tuning RUN/STOP: OFF. Short cut or DI input are same. (PID value is maintained before Auto-tuning operation.)
- After Auto-tuning end, the indicator 'AT' turns OFF and 3-1 Auto-tuning RUN/STOP is set as 'OFF' automatically.
- After Auto-tuning end, each PID value is saved at the different parameters depending on the Zone PID ON/OFF.
It can be individually set to PID value appropriate for the environment.
In case of 3-11 Zone PID: ON, PID 0, 1, 2, 3 group of PID group parameter group is saved automatically at each section.
In case of 3-11 Zone PID: OFF, 3-3 to 8 Heating/Cooling proportional band, integral time, derivative time is saved automatically as Auto-tuning value.
- Even though HHHH/LLLL error occurs, Auto-tuning operation continues. When sensor brake error occurs, Auto-tuning is automatically end. PID value maintains before Auto-tuning operation values.
- When changing 1-7 2-DOF PID control setting, restart Auto-tuning.



Auto-tuning RUN/STOP

- 3-1 Auto-tuning RUN/STOP
- 11-13 to 15 Digital input terminal: AT is set and input the dedicated terminal (digital input has priority.)
- 11-17 to 19 Shortcut function: AT is set and press the dedicated keys in RUN mode

2.3.2. Auto-tuning mode

Description		Display	Default	Set range	Unit	Display condition	
3-2	Auto-tuning mode	Auto-tuning	Auto-tuning	TUN1: Auto-tuning RUN based on SV TUN2: Auto-tuning RUN based on 70% of SV	-	1-6 Operation mode: FIX	6-2 Control method: PID

Auto-tuning mode

TUN1

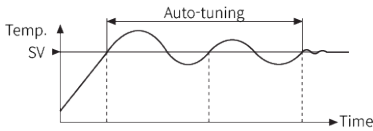

TUN2

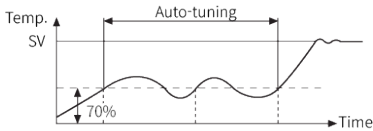

2.3.3. PID control

For PID control, proportional control (P) operates smooth control without hunting, automatically corrects offset with integral action (I), and speeds up response to disturbance with differential action (D).

It shows excellent control results even for control targets with delay time.

- Proportional control (P): Smooth control without hunting
- Integral action (I): Automatically correct offset
- Differential action (D): Fast response to disturbances

2.3.3.1. Heating/Cooling proportional band

Proportional band is the temperature range where PV (current value) is to be controlled by adjusting the ON/OFF ratio during the proportional period (T).

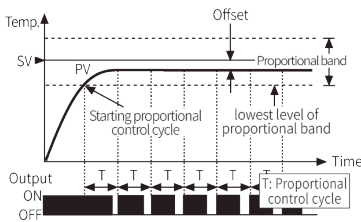

If the proportional band width is increased, the time for the current temperature to reach the set value becomes longer and the offset becomes larger because the control output starts ON and OFF at a lower or higher temperature.

If the proportional band width is made small, the time for the current temperature to reach the set value is short and the offset is small, but hunting is easy to occur because the control output starts ON and OFF operations close to the set value.

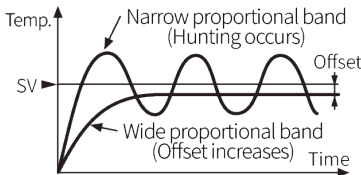

Description		Display	Default	Set range	Unit	Display condition	
3-3	Heating proportional band	H - P	0 10.0	000.1 to 999.9	°C/°F/ -	6-1 Control output operation : HEAT, H-C	6-2 Control method: PID
3-6	Cooling proportional band	C - P	0 10.0			6-1 Control output operation : COOL, H-C	

2.3.3.2. Heating/Cooling integral time

Integral action automatically corrects the offset caused by proportional control to keep the SV stable. Integral time is the unit indicating the strength of the integral operation. It is the time when the MV of the constant deviation and the MV by the proportional operation are same.

If the integral time is shortened, the correction operation becomes stronger and the offset can be removed within a short time, but it causes hunting.

If the integral time is long, the correction operation becomes weak, and it takes a long time to eliminate the offset.

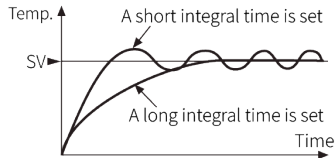
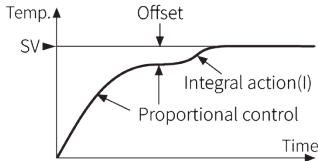

Description		Display	Default	Set range	Unit	Display condition	
3-4	Heating integral time	H - I	0240	0000 (OFF) to 9999	Sec	6-1 Control output operation : HEAT, H-C	6-2 Control method: PID
3-7	Cooling integral time	C - I	0240			6-1 Control output operation : COOL, H-C	

2.3.3.3. Heating/Cooling derivative time

The differential action adjusts the manipulated variable in proportion to the slope of the temperature change, quickly responding to sudden temperature changes due to disturbance and stabilizing the control within a short time.

Derivative time is the unit for the strength of the derivative action. It is the time when the MV of differential and the MV by the proportional control are same.

If the derivative time is shortened, the correction action to the disturbance temperature is weakened, and the response to the sudden temperature change is slowed, but overshoot does not occur.

If the derivative time is long, the correction action for the disturbance temperature becomes stronger, and overshoot is easy to occur.

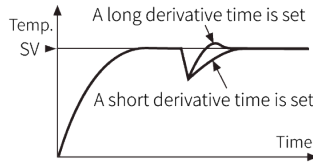
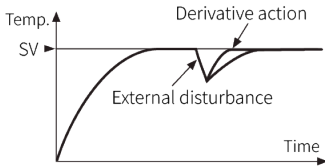

Description		Display	Default	Set range	Unit	Display condition	
3-5	Heating derivative time	H - d	0049	0000 (OFF) to 9999	Sec	6-1 Control output operation : HEAT, H-C	6-2 Control method: PID
3-8	Cooling derivative time	C - d	0049			6-1 Control output operation : COOL, H-C	

2.3.4. Prevents over integration (Anti reset windup)

In order to prevent overshoot due to over-integration, the range of integration operation can be limited.

Integral operation stops when MV reaches the maximum value and restarts when PV reaches the integral operation range (deviation width).

Description		Display	Default	Set range	Unit	Display condition	
3-9	Prevents over integration	RRW.b	OFF	OFF, 50 to 200	%	1-7 2-DOF PID control: OFF	6-2 Control method: PID

Integral range (width of deviation) = Prevents over integration × proportional band



For example,

SV: 50°C, proportional band (P): 10°C, Prevents over integration : 50%, integral range (width of deviation) is below.

$$10\text{ }^{\circ}\text{C} \times 50\% = 5\text{ }^{\circ}\text{C}$$

Example of overshoot caused by over integration

1. If the PID control operation is started with a large deviation between PV and SV, the integral operation is repeated from the start of the control until the set value is reached, resulting in over-integration and overshoot.

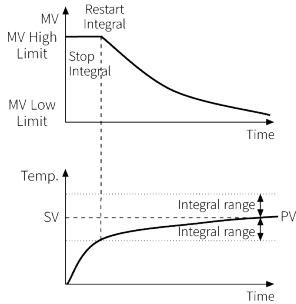

2. If a large deviation occurs in PV and SV due to disturbance during control function execution, the integral operation is repeated from the time the disturbance is released until the set value is reached, resulting in over-integration and overshoot.

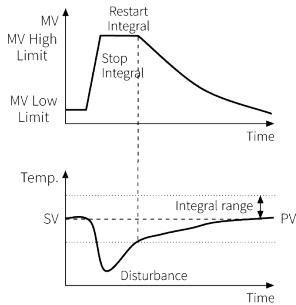

2.3.5. Alpha function

It is available to adjust the response characteristics to set value changes.

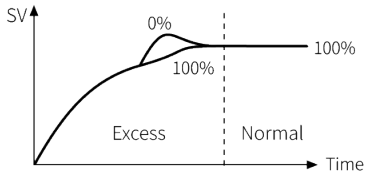

Description		Display	Default	Set range	Unit	Display condition	
3-10	Alpha function	<i>R L F A</i>	<i>50</i>	0 to 100 0: Shorter time to reach SV 100: Extend time to reach SV	%	1-7 2-DOF PID control: ON	6-2 Control method: PID

2.3.6. Zone PID

It is possible to apply a different PID group to each zone by dividing it into 4 zones within the input range.

In the case of a control process with a wide temperature range, the PID data is applied differently to each area because the optimum PID value is different for each temperature range.

For PID 0 to 3 groups, each value can be set in the PID group parameter group.

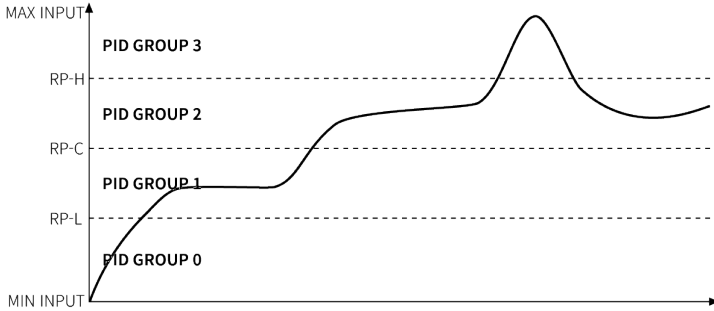

PID group applied by zone (fixed)

Zone	PID group
Input min. value to RP-L	PID 0
RP-L to RP-C	PID 1
RP-C to RP-H	PID 2
RP-H to input max. value	PID 3

When using Zone PID, Auto-tuning proceeds a total of 4 times for each zone. Auto-tuning value are automatically saved for each zone in PID 0, 1, 2, 3 groups of PID group parameter group.

Auto-tuning position by each zone

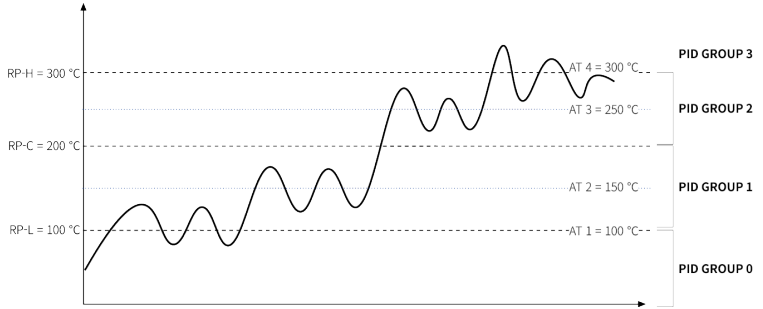

Auto-tuning	Zone	PID group
AT1	RP-L	PID 0
AT2	$(RP-L + RP-C) / 2$	PID 1
AT3	$(RP-C + RP-H) / 2$	PID 2
AT4	RP-H	PID 3



2.3.6.1. Zone PID

Description		Display	Default	Set range	Unit	Display condition
3-11	Zone PID	ZONE	OFF	ON: Zone PID OFF: No Zone PID, basic SV and PID applied	-	6-2 Control method: PID

2.3.6.2. Reference point

Description		Display	Default	Set range	Unit	Display condition
3-12	Reference point low-limit value	RP-L	Min. value + 25% of F.S.	Input min. value to RP-C - 1 digit (RP-L < RP-C < RP-H)	°C/°F/ -	3-11 Zone PID: ON 6-2 Control method: PID
3-13	Reference point center value	RP-C	Min. value + 50% of F.S.	RP-L + 1 digit to RP-H - 1 digit (RP-L < RP-C < RP-H)		
3-14	Reference point high-limit value	RP-H	Min. value + 75% of F.S.	RP-C + 1 digit to Input max. value (RP-L < RP-C < RP-H)		
3-15	Reference point hysteresis	ZHY5	2	1 to 100	°C/°F/ -	4-1 Input type: Temp. H, Analog
			2.0	0.1 to 100.0		4-1 Input type: Temp. L

2.4. Input parameter group: I N

Description		Display	Default	Set range	Unit	Display condition	
4-1	Input type [*]	I N - E	H C R H	1.5.1, "Input Specifications and Usage Range"	-	-	
4-2	Temp. unit	U N I E	°C	°C, °F	-	4-1 Input type: Temperature sensor	
4-3	Analog low-limit value	L - R G	0000	Input min. value to H-RG - F.S 10%	-	4-1 Input type: Analog	
4-4	Analog high-limit value	H - R G	1000	L-RG + F.S 10% to Input max. value			
4-5	Analog scale decimal point	d o t	00	0, 0.0, 0.00, 0.000			
4-6	Analog low-limit scale value	L - S C	0000	-1999 to 9999 ^{(1) (2)}			
4-7	Analog high-limit scale value	H - S C	1000	-1999 to 9999 ^{(1) (2)}			
4-8	Analog display unit	d U N E	° / °	OFF (not used), °C, °F, %			
4-9	Input correct [*]	I N - b	000	-999 to 999	°C/°F/ -		4-1 Input type: Temp. H, Analog
				-199.9 to 999.9			4-1 Input type: Temp. L
4-10	Input digital filter [*]	M A X . F	000.1	000.1 to 120.0	Sec	-	

Description		Display	Default	Set range	Unit	Display condition
4-11	SV low-limit value	L-SV	-200	Min. value of temp. sensor or Analog L-SC to H-SV - 1 digit (< H-SV)	°C/°F/ -	-
4-12	SV high-limit value	H-SV	1350	L-SV + 1 digit to Max. value of temp. sensor or Analog H-SC (> L-SV)		
4-13	Analog transmission output	Pv	PV	[Option: transmission output model] PV: PV transmission SV: SV transmission H-MV: Heating MV transmission C-MV: Cooling MV transmission	-	-
4-14	Analog transmission output range	RaR	4-20	[Option: transmission output model] 4-20, 0-20	mA	-
4-15	Analog transmission output low-limit value	F5L	-200	[Option: transmission output model] Temperature sensor range Analog L-SC to H-SC	-	4-13 Analog transmission output: PV
				L-SV to H-SV		4-13 Analog transmission output: SV
				0 to 1000 (0.0 to 100.0)		4-13 Analog transmission output: H-MV, C-MV

Description		Display	Default	Set range	Unit	Display condition
4-16	Analog transmission output high-limit value	F 5.H	1350	[Option: transmission output model] Temperature sensor range Analog L-SC to H-SC	-	4-13 Analog transmission output: PV
				L-SV to H-SV		4-13 Analog transmission output: SV
				0 to 1000 (0.0 to 100.0)		4-13 Analog transmission output: H-MV, C-MV

2.4.1. Input type

Description		Display	Default	Set range	Unit	Display condition
4-1	Input type	IN - E	℃RH	1.5.1, "Input Specifications and Usage Range"	-	-

- When changing the input type setting,
 - Temperature sensor input: 4-11/12. SV high/low-limit value is changed as the max./min. value of the changed input type.
 - Analog input: 4-3/4. Analog high/low-limit value is changed as the max./min. value of the changed input type.
4-11/12. SV high/low-limit value is changed as 4-6/7. Analog high/low-limit scale value automatically. It is required to reset.
- [Program control model] It cannot be changed while pattern control is in progress.

2.4.2. Temperature unit

Description		Display	Default	Set range	Unit	Display condition
4-2	Temp. unit	UNIT	℃	℃, °F	-	4-1 Input type: Temperature sensor

- [Program control model] It cannot be changed while pattern control is in progress.

2.4.3. Analog input

In case of analog input, input range/display scale range can be set, so it can be displayed in various ways in the user environment.

2.4.3.1. Analog input value

Description		Display	Default	Set range	Unit	Display condition
4-3	Analog low-limit value	L - RG	0000	Input min. value to H-RG - F.S 10%	-	4-1 Input type: Analog
4-4	Analog high-limit value	H - RG	1000	L-RG + F.S 10% to Input max. value		

2.4.3.2. Analog scale value

It is available to set the analog input range (high/low-limit value) to set the display scale (high/low-limit scale value) for the specified input range. It is applied and displayed in various ways in the user environment.

Description		Display	Default	Set range	Unit	Display condition
4-5	Analog scale decimal point	dot	0.0	0, 0.0, 0.00, 0.000	-	4-1 Input type: Analog
4-6	Analog low-limit scale value	L - SC	0000	-1999 to 9999 ^{01) 02)}		
4-7	Analog high-limit scale value	H - SC	1000	-1999 to 9999 ^{01) 02)}		
4-8	Analog display unit	dUNIT	□ / □	OFF (not used), °C, °F, %		

01) Setting range is different by 4-5 Analog scale decimal point place setting.

02) The settings of analog high/low-limit scale value should be different. (L-SC \neq H-SC) If settings are same, the indicator ERR flashes twice. Reset the values.

- Based on 4-3/4 Analog high/low-limit value, $\pm 5\%$ of the input range is extended to the high/low limit, and the output range is also extended by $\pm 5\%$ in proportion to the set value.

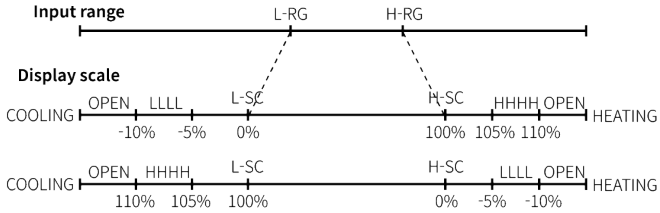

- When PV is over the range of 4-6/7 Analog high/low-limit scale value, it displays as below.
 - Extended by $\pm 5\%$: Flashes PV
 - ± 5 to 10 %: Flashes HHHH/LLLL
 - Over $\pm 10\%$: Flashes OPEN

2.4.4. Input correct

Although there is no error in the control device itself, it is a function to correct input errors that occur from externally input temperature sensors (thermocouples, RTDs), analog input devices, etc.

The input correct function can be mainly used when the sensor cannot be directly attached to the control object to be measured, or when the temperature difference between the location where the sensor is attached and the location to be measured is corrected.

Description		Display	Default	Set range	Unit	Display condition
4-9	Input correct	I N - b	0000	-999 to 999	°C/°F/ -	4-1 Input type: Temp. H, Analog
				-199.9 to 999.9		4-1 Input type: Temp. L



For example, when the actual temperature is 80°C and the displayed temperature of the thermostat is 78°C, set 4-9 Input correct: 002 and the display temperature is 80°C. HHHH or LLLL is displayed when the input correction result value, PV is out of the range for each input sensor.



When using the input correct function, the error occurring in the sensor must be accurately measured before use. If the measured error value is inaccurate, the error range may be larger.

Various temperature sensors are actually graded, and in the case of high-precision type, the price is high, so general products are commonly used. At this time, by measuring the error occurring in each sensor and using the input correct function, more accurate temperature can be measured.

2.4.5. Input digital filter

If the PV repeatedly fluctuates due to the rapid change of the input signal, it is reflected in the MV and stable control is impossible.

This function is to stabilize the PV by setting the input digital filter.

PV may differ from actual value.

Description		Display	Default	Set range	Unit	Display condition
4-10	Input digital filter	MARV.F	000.1	000.1 to 120.0	Sec	-



For example, 4-10 Input digital filter: 0.4 sec. setting, it is displayed by applying a digital filter to the input sampling value for 0.4 seconds (400 ms).

2.4.6. SV high/low-limit value

By limiting the setting range of SV within the use range of temperature sensor/analog input, it is possible to protect the system and prevent control with the setting value that is not appropriate for the system.

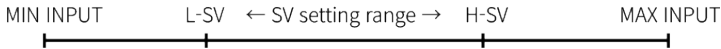

Description		Display	Default	Set range	Unit	Display condition
4-11	SV low-limit value	L - SV	- 200	Min. value of temp. sensor or Analog L-SC to H-SV - 1 digit (< H-SV)	°C/°F/ -	-
4-12	SV high-limit value	H - SV	1350	L-SV + 1 digit to Max. value of temp. sensor or Analog H-SC (> L-SV)		

2.4.7. Analog transmission output

The transmission output is an auxiliary output that converts and send externally the present value (PV), set value (SV), heating MV (H-MV), cooling MV (C-MV), etc. into an analog current of DC 4-20 mA or DC 0-20 mA.

The transmission output is a constant current output. If the resistance value of the load side ($\leq 500 \Omega$) is too large, the output value may change.

2.4.7.1. Analog transmission output

Description		Display	Default	Set range	Unit	Display condition
4-13	Analog transmission output	PV, MV	PV	[Option: transmission output model] PV: PV transmission SV: SV transmission H-MV: Heating MV transmission C-MV: Cooling MV transmission	-	-

2.4.7.2. Analog transmission output range

Description		Display	Default	Set range	Unit	Display condition
4-14	Analog transmission output range	PV, SV	4-20	[Option: transmission output model] 4-20, 0-20	mA	-

2.4.7.3. Analog transmission output high/low-limit value

Description		Display	Default	Set range	Unit	Display condition
4-15	Analog transmission output low-limit value	F 5.L	- 2 0 0	[Option: transmission output model] Temperature sensor range Analog L-SC to H-SC	-	4-13 Analog transmission output: PV
				L-SV to H-SV		4-13 Analog transmission output: SV
				0 to 1000 (0.0 to 100.0)		4-13 Analog transmission output: H-MV, C-MV
4-16	Analog transmission output high-limit value	F 5.H	1 3 5 0	[Option: transmission output model] Temperature sensor range Analog L-SC to H-SC	-	4-13 Analog transmission output: PV
				L-SV to H-SV		4-13 Analog transmission output: SV
				0 to 1000 (0.0 to 100.0)		4-13 Analog transmission output: H-MV, C-MV



When 4-15 Analog transmission output low-limit value and 4-16 Analog transmission output high-limit value are same, depending 4-14 Analog transmission output range setting, low-limit value (4 mA or 0 mA) output turns ON.

2.5. Pattern parameter group: PLEN

This group displays only when program control model and 1-6 Operation mode: PROG.

Program control operates in one of ten patterns.

Up to 20 steps per 1 pattern can be set in detail. Set SV for each step and the step time.

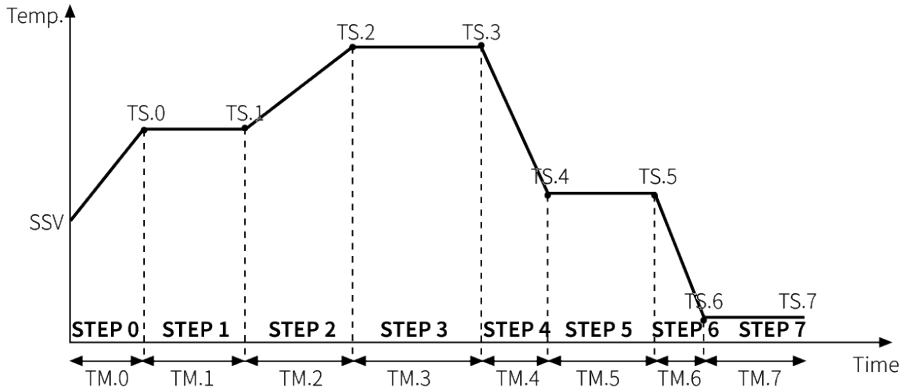

Description		Display	Default	Set range	Unit	Display condition		
5-1	Program time unit *	ELUN1	MM.SS	MM.SS: min.sec HH.MM: hour.min	-	[Program control model] 1-6 Operation mode: PROG	-	
5-2	Pattern start condition *	PE N.S	SSV	SSV: Regardless of PV, pattern operation starts in the pattern step sequence set from the initial SV standard. SPV: Starts operation at STEP position corresponding to PV.	-		-	
5-3	Pattern standby action width *	WELb	2	0 to 999	-	4-1 Input type: Temp. H	-	
				0.0 to 999.9				4-1 Input type: Temp. L
				0.0 to 100.0				4-1 Input type: Analog
5-4	Pattern standby time *	WELt	00.00	0.0 to 99.59, 99.60 (infinite wait)	5-1 Program time unit	-	-	
5-5	Pattern number *	PE N.N	PE N.D	PTN.0 to PTN.9	-	-	-	
5-6	Pattern <input type="checkbox"/> repeat count *	REP	0	0 to 9999, CONT	-	-	-	

Description		Display	Default	Set range	Unit	Display condition	
5-7	Pattern <input type="checkbox"/> state after end *	P.E.N.d	5 t o P	STOP: Stops control output HOLD: Maintains the last step SV NEXT: Converts to the next pattern PRE: Converts to the previous pattern	-	[Program control model] 1-6 Operation mode: PROG	-
5-8	Pattern <input type="checkbox"/> PID *	P.P.i.d	P.i.d.0	PID.0 to PID.7	-		6-2 Control method: PID
5-9	Pattern <input type="checkbox"/> steps *	5 t E P	0	0 to 20	-		-
5-10	Step <input type="checkbox"/> SV *	t S.□	0	L-SV to H-SV	-		-
5-11	Step <input type="checkbox"/> time *	t M.□	00.00	00.00 to 99.59	5-1 Program time unit		-

2.5.1. Program time unit

Sets the time unit for the program control setting parameters.

- 5-4 Pattern standby time
- 5-11 Step 0 to 19 time

Description	Display	Default	Set range	Unit	Display condition
5-1 Program time unit	<i>t.U.NI</i>	<i>MM.SS</i>	[Program control model] MM.SS: min.sec HH.MM: hour.min	-	1-6 Operation mode: PROG

2.5.2. Pattern start condition

Set the condition for starting the pattern.

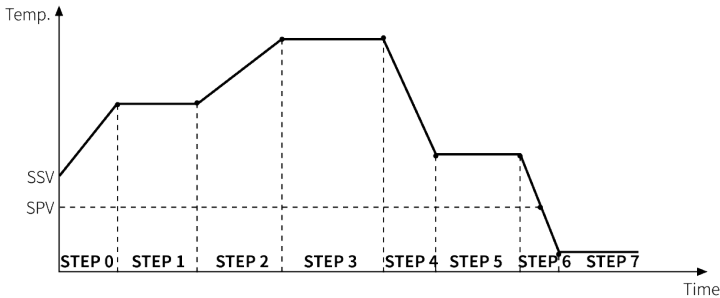

Description	Display	Default	Set range	Unit	Display condition
5-2 Pattern start condition	<i>Pt.N.S</i>	<i>SSV</i>	[Program control model] SSV: Regardless of PV, pattern operation starts in the pattern step sequence set from the initial SV standard. SPV: Starts operation at STEP position corresponding to PV.	-	1-6 Operation mode: PROG

2.5.3. Pattern standby action

In case of a deviation between the current SV and PV at the time of step replacement during program control, it waits without proceeding to the next step until the PV enters the preset deviation (standby operation width/range) for the SV.

It waits for the set waiting time and, if the time elapses, proceeds to the next step regardless of the deviation.

Description		Display	Default	Set range	Unit	Display condition	
5-3	Pattern standby action width	W L.b	2	[Program control model] 0 to 999	-	1-6 Operation mode: PROG	4-1 Input type: Temp. H
				0.0 to 999.9			4-1 Input type: Temp. L
				0.0 to 100.0			4-1 Input type: Analog
5-4	Pattern standby time	W L.t	00.00	[Program control model] 0.0 to 99.59, 99.60 (infinite wait)	5-1 Program time unit	-	-

- Waiting action cancels the standby operation within the waiting time

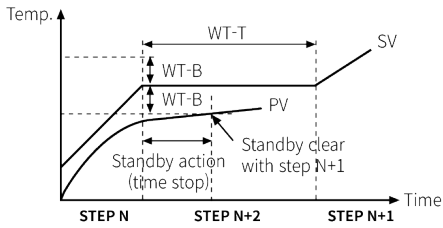

- If the standby action does not reach the standby width/band within the standby time

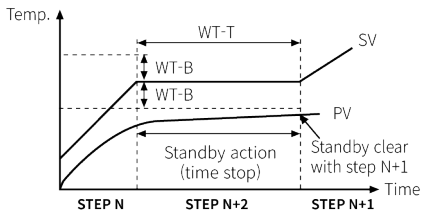

2.5.4. Pattern number

Description		Display	Default	Set range	Unit	Display condition
5-5	Pattern number	<i>PEN</i>	<i>PEN</i>	[Program control model] PTN.0 to PTN.9	-	1-6 Operation mode: PROG

The pattern number cannot be changed while the program is in progress.

The parameters of the corresponding pattern are activated within the group.

2.5.5. Pattern repeat count

Set repeat count of the pattern which is set 5-5 Pattern number.

The entire pattern is operated by the set number of times + 1 time.

Description		Display	Default	Set range	Unit	Display condition
5-6	Pattern <input type="checkbox"/> repeat count	<i>REP</i>	<i>0</i>	[Program control model] 0 to 9999, CONT	-	1-6 Operation mode: PROG

2.5.6. Pattern state after end

Set the operation state after end of the pattern which is set 5-5 Pattern number.

Description	Display	Default	Set range	Unit	Display condition
5-7 Pattern <input type="checkbox"/> state after end	<i>P.E N d</i>	<i>S t o P</i>	[Program control model] STOP: Stops control output HOLD: Maintains the last step SV NEXT: Converts to the next pattern PRE: Converts to the previous pattern	-	1-6 Operation mode: PROG

Operation state after end of the pattern

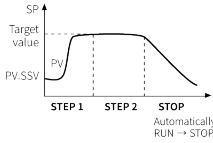
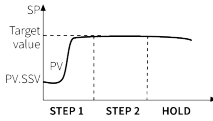
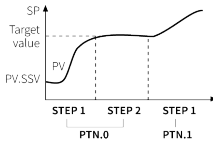
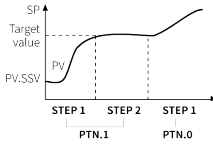
Status	Description
STOP	 <p>Stops control output</p>
HOLD	 <p>Maintains the last step SV</p>
NEXT	 <p>Converts to the next pattern. If there is no next pattern it stops.</p>
PRE	 <p>Converts to the previous pattern. If there is no previous pattern it stops.</p>

2.5.7. Pattern PID

Set the pattern PID of the pattern which is set 5-5 Pattern number.

PID groups are available to set each value at PID group parameter group.

Description		Display	Default	Set range	Unit	Display condition	
5-8	Pattern <input type="checkbox"/> PID	<i>P.Pid</i>	<i>Pid0</i>	[Program control model] PID.0 to PID.7	-	1-6 Operation mode: PROG	6-2 Control method: PID



When 3-11 Zone PID: ON, the saved value of each zone PID is applied to the PV.

2.5.8. Steps

Set the steps for the pattern which is set 5-5 Pattern number.

Up to 20 steps (0 to 19) per 1 pattern can be set in detail.

Description		Display	Default	Set range	Unit	Display condition
5-9	Pattern <input type="checkbox"/> steps	5 5 E P	0	[Program control model] 0 to 20	-	1-6 Operation mode: PROG

2.5.9. Step SV and time

Set SV (for end point) and required time of each step for the pattern which is set 5-5 Pattern number.

Depending on the set 5-9 Steps number, the below parameters are displayed.

Each step has SV and time.

During step progressing, step displays the current step.

Description		Display	Default	Set range	Unit	Display condition
5-10	Step <input type="checkbox"/> SV	5 5 . <input type="checkbox"/>	0	[Program control model] L-SV to H-SV	-	1-6 Operation mode: PROG
5-11	Step <input type="checkbox"/> time	5 5 . <input type="checkbox"/>	0 0 0 0	[Program control model] 00.00 to 99.59	5-1 Program time unit	

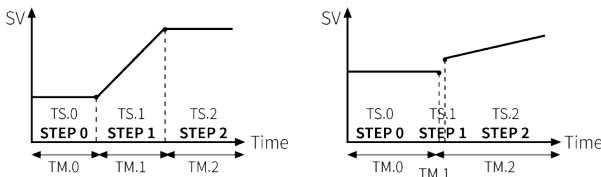

STEP1 SV is $SSV=TS.0$ and start point and end point are same.

STEP2 SV is $TS.0 < TS.1$ and form connected in a straight line up to $TS.1$.

STEP3 is $TS.2=TS.1$ and it controls STEP2 end point SV for STEP3 time.

If the step time is set too small, the steps are configured as (STEP 2).

2.6. Control parameter group: C N E L

Description		Display	Default	Set range	Unit	Display condition	
6-1	Control output operation	o - F E	H - C	HEAT: Heating control COOL: Cooling control H-C: Heating (OUT1) - Cooling (OUT2) control	-	-	
6-2	Control method	C - M d	P i d	PID, ONOF: ON/OFF	-	6-1 Control output operation: HEAT, COOL	
			P, P	Heating (OUT1) - Cooling (OUT2) P.P: PID - PID P.ON: PID - ON/OFF ON.P: ON/OFF - PID ON.ON: ON/OFF - ON/OFF		6-1 Control output operation : H-C	1-7 2-DOF PID control: OFF
			P, P	P.P: PID - PID ON.ON: ON/OFF - ON/OFF			1-7 2-DOF PID control: ON
6-3	Sampling cycle	S P L E	5 0	50, 100, 25	msec	-	
6-4	OUT 1 control output	o U E I	C U R R	[OUT1: current output model] SSR, CURR	-	-	
6-5	OUT 1 SSR drive output method	o I S R	S E N D	[OUT1: SSR drive output model] STND: Standard ON/OFF control CYCL: Cycle control PHAS: Phase control	-	-	
6-6	OUT 1 current output range	o I M R	4 - 2 0	[OUT1: current output model] 4-20, 0-20	mA	-	6-4 OUT 1 control output: CURR

Description		Display	Default	Set range	Unit	Display condition	
6-7	OUT 2 control output	OUT2	CURR	[OUT2: current output model] SSR, CURR	-	-	
6-8	OUT 2 SSR drive output method	OUT2P	STND	[OUT2: SSR drive output model] STND: Standard ON/OFF control CYCL: Cycle control PHAS: Phase control		-	
6-9	OUT 2 current output range	OUT2R	4-20	[OUT2: current output model] 4-20, 0-20	mA	-	6-7 OUT 2 control output: CURR
6-10	Heating control cycle	HEAT	0.00	[Relay output model] 000.1 to 120.0	Sec	6-1 Control output operation : HEAT, H-C	-
			0.0	[SSR drive output model] 000.1 to 120.0			6-5/8 SSR drive output method: STND
			0.00	[Current output model] 001.0 to 120.0			6-4/7 control output: SSR
6-11	Cooling control cycle	COOL	0.00	[Relay output model] 000.1 to 120.0	Sec	6-1 Control output operation : COOL, H-C	-
			0.0	[SSR drive output model] 000.1 to 120.0			6-5/8 SSR drive output method: STND
			0.00	[Current output model] 001.0 to 120.0			6-4/7 control output: SSR

Description		Display	Default	Set range	Unit	Display condition	
6-12	Heating-Cooling control, dead band	d b	0000	-999 to 0 (OFF) to 999	°C/°F	6-1 Control output operation :H-C	4-1 Input type: Temp. H
			0000	-199.9 to 0 (OFF) to 999.9			4-1 Input type: Temp. L
			0000	-99.9 to 0 (OFF) to 99.9	% F.S.		4-1 Input type: Analog
6-13	Manual reset	R E S E T	0500	000.0 to 100.0	%	6-1 Control output operation : HEAT, COOL	6-2 Control method: PID 3-4/7 integral time: 0
6-14	Heating hysteresis	H H Y S	002	001 to 100	°C/°F/ -	6-1 Control output operation : HEAT, H-C, 6-2	4-1 Input type: Temp. H, Analog
				000.1 to 100.0			4-1 Input type: Temp. L
6-15	Heating offset	H o S E T	000	000 to 100	°C/°F/ -	Control method: ON/OFF	4-1 Input type: Temp. H, Analog
				000.0 to 100.0			4-1 Input type: Temp. L

Description		Display	Default	Set range	Unit	Display condition		
6-16	Cooling hysteresis	C.HYS	002	001 to 100	°C/°F/ -	6-1 Control output operation : COOL, H- C, 6-2	4-1 Input type: Temp. H, Analog	
				000.1 to 100.0			4-1 Input type: Temp. L	
6-17	Cooling offset	C.OSE	000	000 to 100	°C/°F/ -	Control method: ON/OFF	4-1 Input type: Temp. H, Analog	
				000.0 to 100.0			4-1 Input type: Temp. L	
6-18	MV low-limit value *	L-MV	-00.0	000.0 to H-MV - 0.1	%	6-1 Control output operation : HEAT, COOL	-	
				-100.0 to 000.0			6-1 Control output operation : H-C	6-2 Control method: PID
				0.0: OFF, -100.0: ON				6-2 Control method: ONOF

Description		Display	Default	Set range	Unit	Display condition	
6-19	MV high-limit value	H-MV	100.0	L-MV + 0.1 to 100.0	%	6-1	-
				000.0 to 100.0		6-1	6-2
						Control output operation : HEAT, COOL	Control method: PID
0.0: OFF, 100.0: ON	6-2	Control method: ONOF					
6-20	Timer mode	t-M-F	OFF	[Fixed control model] OFF: Not used T.ON: ON timer T.OFF: OFF timer T.ONF: ON-OFF timer T.SET: SV SET timer	-	-	
6-21	ON time	t.ON	00.00	00.00 to 99.59	HH.MM	6-20 Timer mode: T.ON, T.ONF	
6-22	OFF time	t.OFF	00.00	00.00 to 99.59	HH.MM	6-20 Timer mode: T.OFF, T.ONF	
6-23	SV SET time	t.SET	00.00	00.00 to 99.59	HH.MM	6-20 Timer mode: T.SET	
6-24	Ramp up rate	RRMU	000	000 to 999	°C/°F/-	1-6 Operation mode: FIX	4-1 Input type: Temp. H, Analog
6-25	Ramp down rate	RRMd	000	000.0 to 999.9			4-1 Input type: Temp. L
6-26	Ramp time	RRMt	60	1 to 3600	Sec		-

2.6.1. Control output operation

Heating control and cooling control are opposite actions, and the control output is output in the opposite direction.

During PID control, the PID value is different because the PID value is determined according to the control object.

Description		Display	Default	Set range	Unit	Display condition
6-1	Control output operation	□ - F E	H - C	HEAT: Heating control COOL: Cooling control H-C: Heating (OUT1) - Cooling (OUT2) control	-	-

Heating control

In case of $PV < SV$, power is applied to the load.

Cooling control

In case of $PV > SV$, power is applied to the load.

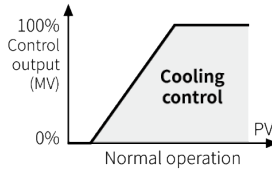
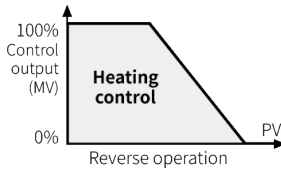

Heating & Cooling control

If it is difficult to control the temperature of the control object with only heating or cooling output, more ideal temperature control is possible by simultaneously controlling the heating and cooling outputs with one temperature controller.

Heating/Cooling control is controlled by dividing the PID value into heating and cooling.

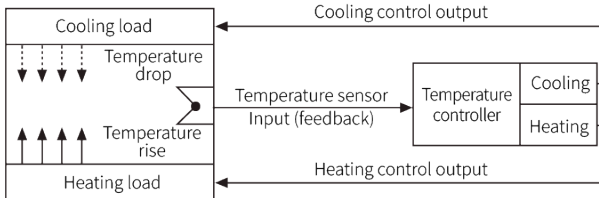

2.6.2. Control method

Description		Display	Default	Set range	Unit	Display condition	
6-2	Control method	C-Md	Pi d	PID, ONOF: ON/OFF	-	6-1 Control output operation: HEAT, COOL	
			P,P	Heating (OUT1) - Cooling (OUT2) P.P: PID - PID P.ON: PID - ON/OFF ON.P: ON/OFF - PID ON.ON: ON/OFF - ON/OFF		6-1 Control output operation : H-C	1-7 2-DOF PID control: OFF
			P.P: PID - PID ON.ON: ON/OFF - ON/OFF	1-7 2-DOF PID control: ON			

2.6.3. Sampling cycle

Description		Display	Default	Set range	Unit	Display condition
6-3	Sampling cycle	SPLt	50	50, 100, 25	msec	-

2.6.4. OUT 1/2 control output

Description		Display	Default	Set range	Unit	Display condition
6-4	OUT 1 control output	OUT 1	CURR	[OUT1: current output model] SSR, CURR	-	-
6-7	OUT 2 control output	OUT 2	CURR	[OUT2: current output model] SSR, CURR		

2.6.5. OUT 1/2 SSR drive output method

Description		Display	Default	Set range	Unit	Display condition
6-5	OUT 1 SSR drive output method	0.15P	5tNd	[OUT1: SSR drive output model] STND: Standard ON/OFF control CYCL: Cycle control PHAS: Phase control	-	-
6-8	OUT 2 SSR drive output method	0.25P	5tNd	[OUT2: SSR drive output model] STND: Standard ON/OFF control CYCL: Cycle control PHAS: Phase control	-	-

Standard ON/OFF control

It controls ON (100% output) / OFF (0% output) in the same way as general relay output.

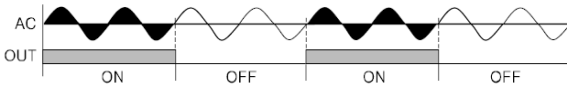

Cycle control

It controls the load power by repeating ON/OFF as much as the output amount ratio based on a certain period.

The degree of control is almost the same as that of phase control. Since it is always ON or OFF at the zero point of AC in the zero-cross method, the switching noise can be improved compared to the phase control.

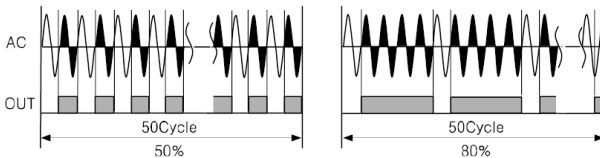

Phase control

Continuous control is possible by controlling the load power by controlling the phase within the AC half cycle.

Be sure to use random turn-on SSRs.

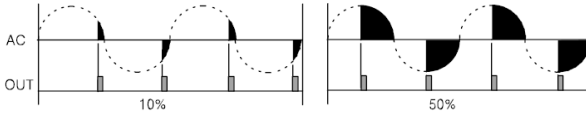

2.6.6. OUT 1/2 current output range

Description		Display	Default	Set range	Unit	Display condition
6-6	OUT 1 current output range	0 1.MA	4 - 20	[OUT1: current output model] 4-20, 0-20	mA	6-4 OUT 1 control output: CURR
6-9	OUT 2 current output range	0 2.MA	4 - 20	[OUT2: current output model] 4-20, 0-20		6-7 OUT 2 control output: CURR

2.6.7. Heating/Cooling control cycle

Set the cycle for repeatedly outputting MV.

By applying the current MV as a ratio to the set control cycle, it is turned on for the calculated time, and the remaining time is turned off repeatedly.

Description		Display	Default	Set range	Unit	Display condition	
6-10	Heating control cycle	H - t	20.0	[Relay output model] 000.1 to 120.0	Sec	6-1 Control output operation : HEAT, H-C	-
			2.0	[SSR drive output model] 000.1 to 120.0			6-5/8 SSR drive output method: STND
			20.0	[Current output model] 001.0 to 120.0			6-4/7 control output: SSR
6-11	Cooling control cycle	C - t	020.0	[Relay output model] 000.1 to 120.0	Sec	6-1 Control output operation : COOL, H-C	-
			2.0	[SSR drive output model] 000.1 to 120.0			6-5/8 SSR drive output method: STND
			20.0	[Current output model] 001.0 to 120.0			6-4/7 control output: SSR

2.6.8. Heating-Cooling control dead band

In heating-cooling control, the area between heating control and cooling control can be designated based on SV.

When set to '+', a dead band is formed based on SV and no control is performed within the set section.

That is, in the section within the dead band, the heating/cooling MV becomes 0.0%.

When set to a '-' value, an overlap band is formed based on SV, and heating and cooling MV are simultaneously applied and controlled within the set section.

Description		Display	Default	Set range	Unit	Display condition	
6-12	Heating-Cooling control dead band	db	0000	-999 to 0 (OFF) to 999	°C/°F	6-1 Control output operation :H-C	4-1 Input type: Temp. H
			0000	-199.9 to 0 (OFF) to 999.9			4-1 Input type: Temp. L
			0000	-99.9 to 0 (OFF) to 99.9	% F.S.		4-1 Input type: Analog

(1) Not used dead/overlap band

- Heating P - Cooling P control

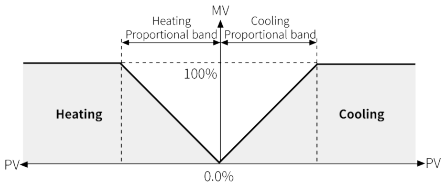

- Heating P - Cooling ON/OFF control

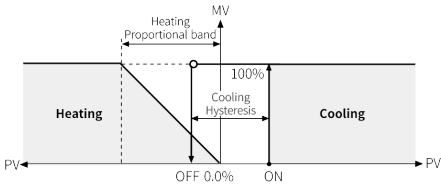

- Heating ON/OFF - Cooling P control

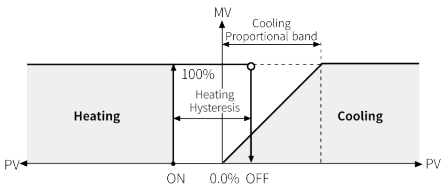

- Heating ON/OFF - Cooling ON/OFF control

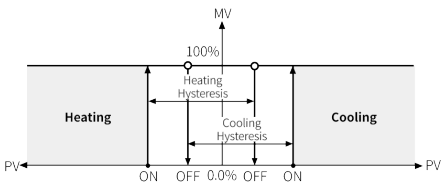

(2) Used dead band

- Heating P - Cooling P control, Dead band 10 °C/°F

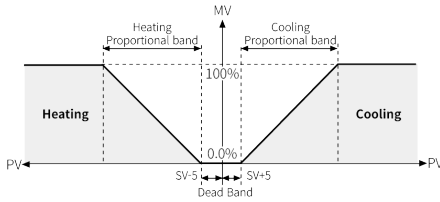

- Heating P - Cooling ON/OFF control, Dead band 10 °C/°F

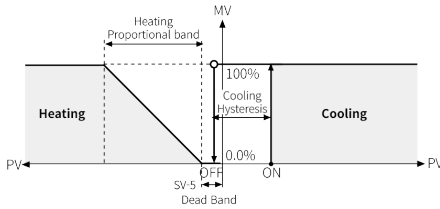

- Heating ON/OFF - Cooling P control, Dead band 10 °C/°F

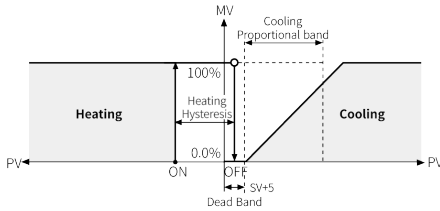

- Heating ON/OFF - Cooling ON/OFF control, Dead band 10 °C/°F

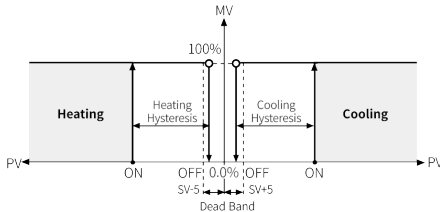

(3) Used overlap band

- Heating P - Cooling P control, Overlap band -10 °C/°F

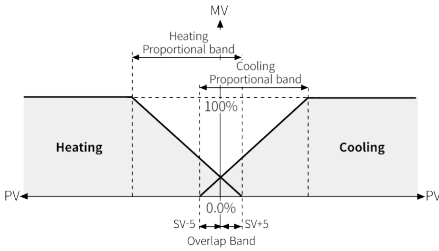

- Heating P - Cooling ON/OFF control, Overlap band -10 °C/°F

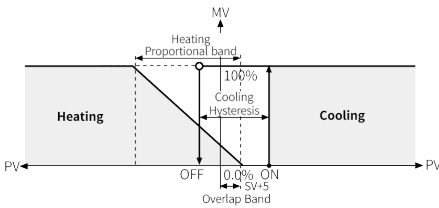

- Heating ON/OFF - Cooling P control, Overlap band -10 °C/°F

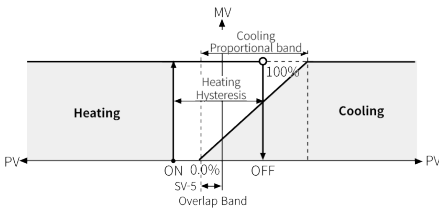

- Heating ON/OFF - Cooling ON/OFF control, Overlap band -10 °C/°F

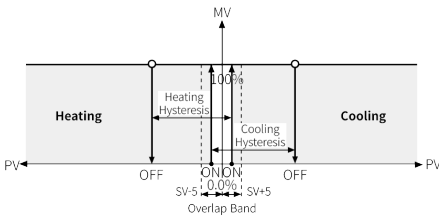

2.6.9. Manual reset

In case of using only proportional control (P, PD control), the rise time and fall time of the heater are different depending on the heat capacity and heater capacity of the control object, so even when the control is stable, a certain amount of deviation occurs. This deviation is called the Offset.

Normal deviation can be set/corrected by manual reset.

When control is stable, if PV and SV are the same, set it to 50%. If PV is lower than SV, increase the setting value to more than 50.0%. Conversely, if PV is higher than SV, set the setting value to less than 50.0%.

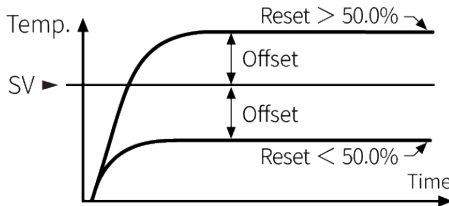

Description		Display	Default	Set range	Unit	Display condition	
6-13	Manual reset	RESET	0500	000.0 to 100.0	%	6-1 Control output operation : HEAT, COOL ⁰²⁾	6-2 Control method: PID 3-4/7 integral time: 0 ⁰¹⁾

01) In case of 6-1 Control output operation: H-C, Heating/Cooling operates as 0% automatically. If changing 6-1 Control output operation setting, Manual reset operates as the previous value.

02) If changing 3-4/7 integral time setting, Manual reset operates as the previous value.

2.6.10. Heating/Cooling hysteresis and offset

Set the output change time of ON/OFF items based on a specific value, such as ON/OFF control or alarm.

If the output change operates only at the set value, the output is easily oscillated or affected by noise, so the ON/OFF operation is performed within the interval with hysteresis.

Setting the hysteresis too small can cause hunting due to disturbances (noise, chattering, etc.).

Consider the environment and set it to a value that minimizes the occurrence of hunting.

Description		Display	Default	Set range	Unit	Display condition	
6-14	Heating hysteresis	H.HYS	002	001 to 100	°C/°F/ -	6-1 Control output operation : HEAT, H- C, 6-2	4-1 Input type: Temp. H, Analog
				000.1 to 100.0			4-1 Input type: Temp. L
6-15	Heating offset	H.OSE	000	000 to 100	°C/°F/ -	Control method: ON/OFF	4-1 Input type: Temp. H, Analog
				000.0 to 100.0			4-1 Input type: Temp. L
6-16	Cooling hysteresis	C.HYS	002	001 to 100	°C/°F/ -	6-1 Control output operation : COOL, H- C, 6-2	4-1 Input type: Temp. H, Analog
				000.1 to 100.0			4-1 Input type: Temp. L
6-17	Cooling offset	C.OSE	000	000 to 100	°C/°F/ -	Control method: ON/OFF	4-1 Input type: Temp. H, Analog
				000.0 to 100.0			4-1 Input type: Temp. L

When the hysteresis of the temperature controller with a temperature range of 0 to 400 °C is 0.2%, the section becomes 0.8 °C, and when the set value is 100 °C, it turns ON at 99.6 °C and OFF at 100.4 °C.

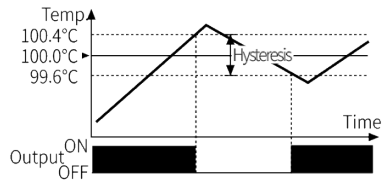

2.6.11. MV high/low-limit value

Set the MV high/low-limit value of the control output to limit the MV range. If the MV calculated by the temperature controller is out of the range, the MV is limited to high/low-limit values.

During heating & cooling control, cooling MV is displayed as - value.

High-limit value is set to + value for heating, and low-limit value is set to - value for cooling.

Normal (fixed) control

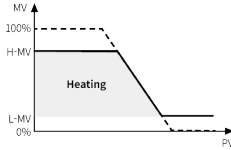

Heating-Cooling control

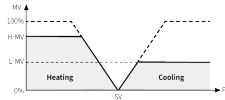

Description		Display	Default	Set range	Unit	Display condition	
6-18	MV low-limit value	L - MV	100.0	000.0 to H-MV - 0.1	%	6-1	-
				-100.0 to 000.0		6-1	Control output operation : HEAT, COOL
				0.0: OFF, -100.0: ON		6-1	Control output operation : H-C
						6-2	Control method: PID
						6-2	Control method: ONOF

Description		Display	Default	Set range	Unit	Display condition	
6-19	MV high-limit value	H - MV	100.0	L-MV + 0.1 to 100.0	%	6-1 Control output operation : HEAT, COOL	-
				000.0 to 100.0		6-1 Control output operation : H-C	6-2 Control method: PID
				0.0: OFF, 100.0: ON			6-2 Control method: ONOF

- During Auto-tuning operation, MV high/low-limit value is applied.
- In case of manual control / STOP, MV / Sensor error, MV high/low-limit value is not applied.

2.6.12. Timer

It can be limited control output by setting the start, progress, and end time.

Description		Display	Default	Set range	Unit	Display condition
6-20	Timer mode	EM-F	OFF	[Fixed control model] OFF: Not used T.ON: ON timer T.OFF: OFF timer T.ONF: ON-OFF timer T.SET: SV SET timer	-	-
6-21	ON time	EM	00.00	00.00 to 99.59	HH.M M	6-20 Timer mode: T.ON, T.ONF
6-22	OFF time	EMFF	00.00	00.00 to 99.59	HH.M M	6-20 Timer mode: T.OFF, T.ONF
6-23	SV SET time	EMEt	00.00	00.00 to 99.59	HH.M M	6-20 Timer mode: T.SET

Timer mode

Mode	Operation	Description
OFF		It starts control simultaneously with the operation start signal. Control is continuous until the operation is stopped.
ON timer		ON time proceeds simultaneously with the operation start signal. Control turns OFF during ON time. Control is turned ON after ON time.
OFF timer		OFF time proceeds simultaneously with the operation start signal. Control turns ON during OFF time. After the OFF time, the control is turned OFF.

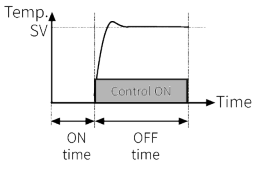
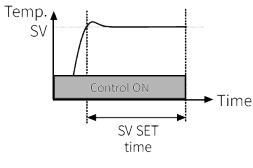
Mode	Operation	Description
ON/OFF timer		<p>ON time proceeds at the same time as operation start signal and control is turned OFF.</p> <p>After the ON time, the OFF time proceeds and the control is turned ON.</p> <p>After the OFF time, the control is turned OFF.</p>
SV SET timer		<p>It starts control simultaneously with the operation start signal.</p> <p>When the current temperature (PV) is higher than the set temperature (SV), the control output is maintained for the SV SET time and then the control is turned OFF.</p>

- If time is not set during timer operation, TMR.E flashes twice and control output stops.
- Time setting change is possible even while time is in progress. It does not apply to the past time.
- Pause (30 minutes) according to 1-2 Pause timer/pattern settings. If it is maintained for more than 30 minutes, the control output is stopped.
- 1-2 If the Pause timer/pattern setting is changed from PAUS to CONT, the remaining time is resumed.
- 11-6 STOP and MV has priority.
- 11-5 Sensor error, MV has priority. The time operation ends and the set time is maintained. After clearing the error, restart from the beginning.

2.6.13. Ramp

Ramp function is to set the change temperature per unit time reaching the set value (SV).

The rapid temperature change (heating or cooling) of the control object is limited the rate of change of the set value (SV) during control.

Ramp function is mainly used in the field where a problem may be caused to the control object by rapid temperature control (heating or cooling).

The temperature control of the control object is based on the SV (hereinafter referred to as RAMP SV) that is changed based on the set rate of change (change temperature per unit time).

Ramp up change rate and ramp down change rate can be set independently.

During ramp operation, the alarm operates based on the final SV.

Displays the RAMP SV of the front SV display during ramp operation.

Description		Display	Default	Set range	Unit	Display condition	
6-24	Ramp up rate	<i>RRMU</i>	000	000 to 999	°C/°F/ -	1-6 Operation mode: FIX	4-1 Input type: Temp. H, Analog
6-25	Ramp down rate	<i>RRMd</i>	000	000.0 to 999.9			4-1 Input type: Temp. L
6-26	Ramp time	<i>RRML</i>	50	1 to 3600	Sec		-

Status	RAMP RATE	RAMP function
OPEN, HHHH, LLLL, Auto-Tuning, Auto → Manual, RUN → STOP, After Auto-tuning end, PV = SV	Regardless conditions	Not operated
Power supply, SV change, STOP → RUN, Manual → Auto, Changing Ramp rate during ramp	≠ 0	Operates

- Ramp ON at not operated Ramp operation

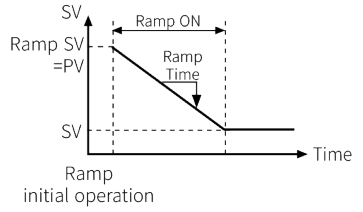
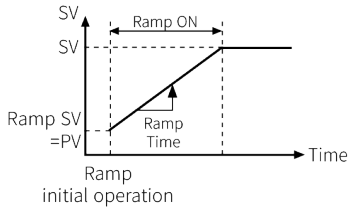

- SV or Ramp parameter changing during Ramp operation

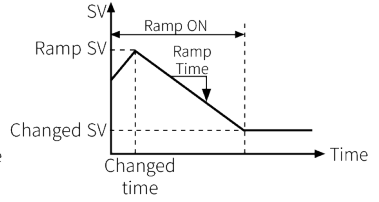
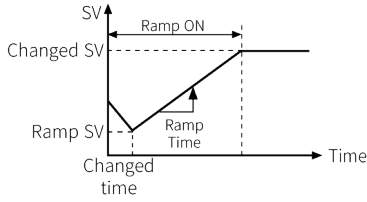

2.7. PID group parameter group: *PID*

PID group (0 to 7 group) are available to set.

- In case of 3-11 Zone PID: ON, each zone has PID group (0 to 3 group, fixed).
During Auto-tuning operation, PID value is applied to the current PID group.
- 5-8 Pattern PID parameter sets PID group of each pattern.

Description	Display	Default	Set range	Unit	Display condition
7-1 PID group number	<i>PID.N</i>	<i>PID.0</i>	PID.0 to PID.7	-	-
7-2 PID <input type="checkbox"/> group heating proportional band	<i>H - P.□</i>	<i>10.0</i>	000.1 to 999.9	°C/°F /-	6-1 Control output operation: n: HEAT, H-C
7-3 PID <input type="checkbox"/> group heating integral time	<i>H - I.□</i>	<i>240</i>	0000 to 9999	Sec	
7-4 PID <input type="checkbox"/> group heating derivative time	<i>H - d.□</i>	<i>49</i>	0000 to 9999	Sec	
7-5 PID <input type="checkbox"/> group cooling proportional band	<i>H - P.□</i>	<i>10.0</i>	000.1 to 999.9	°C/°F /-	
7-6 PID <input type="checkbox"/> group cooling integral time	<i>H - I.□</i>	<i>240</i>	0000 to 9999	Sec	6-1 Control output operation: n: COOL, H-C
7-7 PID <input type="checkbox"/> group cooling derivative time	<i>H - d.□</i>	<i>49</i>	0000 to 9999	Sec	

2.8. Event parameter group: *EVNE*

Description		Display	Default	Set range	Unit	Display condition	
8-1	Event	<i>EV.N</i>	<i>EV.0</i>	EV.0 to EV.9	-	-	
8-2	Event <input type="checkbox"/> alarm output operation mode	<i>ALMd</i>	<i>dVCC</i>	OFF: Not used DV[: Deviation high-limit alarm]DV: Deviation low-limit alarm]DV[: Deviation high/low-limit alarm [DV]Deviation high/low-limit reverse alarm PV[: Absolute value high-limit alarm]]PV: Absolute value low-limit alarm LBA: Loop break alarm SBA: Sensor break alarm HBA1: Heater break alarm (CT1) HBA2: Heater break alarm (CT2) + RUN: Control output ON notice + STOP: Control output OFF notice + PAUS: Control output PAUSE notice + P.ST: Pattern control start notice + P.END: Pattern control end notice + P.OT: Pattern control delay point notice + S.ST: Step start notice + S.END: Step end notice + S.OT: Step delay point notice	-	+ [Program control model] 1-5 Operation mode: PROG	8-1 Event: EV.0 to EV.1
			<i>OFF</i>				8-1 Event: EV.2 to EV.9

Description		Display	Default	Set range	Unit	Display condition		
8-3	Event <input type="checkbox"/> alarm output low-limit value *	ALL	1550	-F.S to F.S	°C/°F	8-2 Alarm output operation mode: DV[[to [DV]	4-1 Input type: Temp. sensor	
				Display range		8-2 Alarm output operation mode: PP[[to]]PV		
			1000	-1999 to -F.S to F.S to 9999	Digit	8-2 Alarm output operation mode: DV[[to [DV]		4-1 Input type: Analog
				Display range		8-2 Alarm output operation mode: PP[[to]]PV		
8-3	Event <input type="checkbox"/> Heater break value *	ALL	000	[OUT1/2: Relay or SSR drive output model] 00.0 to 50.0	A	6-5/8 OUT1/2 SSR drive output method: STND	8-2 Alarm output operation mode: HBA <input type="checkbox"/>	

Description		Display	Default	Set range	Unit	Display condition	
8-4	Event <input type="checkbox"/> alarm output high-limit value [*]	RLH	1550	-F.S to F.S	°C/°F	8-2 Alarm output operation mode: DV[[to [DV]	4-1 Input type: Temp. sensor
				Display range			
				-1999 to -F.S to F.S to 9999	Digit	8-2 Alarm output operation mode: DV[[to [DV]	
						Display range	
8-5	Event <input type="checkbox"/> alarm output hysteresis [*]	RLHY	001	001 to 100	°C/°F /-	4-1 Input type: Temp. H, Analog	8-2 Alarm output operation mode: DV[[to]]PV, HBA <input type="checkbox"/>
				000.1 to 100.0		4-1 Input type: Temp. L	

Description		Display	Default	Set range	Unit	Display condition	
8-6	Event <input type="checkbox"/> LBA monitor time	L b R.t	0000	0000 (OFF) to 9999	Sec	8-2 Alarm output operation mode: LBA	
8-7	Event <input type="checkbox"/> LBA detection band	L b R.b	002	000 (OFF) to 999	°C/°F	8-6 Event LBA monitor time: > 0	4-1 Input type: Temp. H
			002.0	000 (OFF) to 999	°C/°F		4-1 Input type: Temp. L
			000.2	000.0 (OFF) to 100.0	%F.S		4-1 Input type: Analog
8-8	Event <input type="checkbox"/> notice Pattern/Step	R L.P	R L L	PTN.0 to PTN.9, ALL	-	8-2 Alarm output operation mode: P.ST to P.OT	
				ST.0 to ST.19, ALL	-	8-2 Alarm output operation mode: S.ST to S.OT	
8-9	Event <input type="checkbox"/> output	R L.o	R L. 1	AL.1 to AL.6, OFF	-	8-1 Event: EV.0	
			R L.2			8-1 Event: EV.1	
			o F F			8-1 Event: EV.2 to EV.9	

2.8.1. Event

Set alarm operation mode, alarm output high/low-limit value, and control sensitivity for each event.

Description		Display	Default	Set range	Unit	Display condition
8-1	Event	<i>EV.N</i>	<i>EV.0</i>	EV.0 to EV.9	-	-

2.8.2. Alarm output operation mode

Set Alarm output operation mode of 8-1 Event.

Depending on the model and setting, the setting range is different.

Description	Display	Default	Set range	Unit	Display condition	
8-2 Event <input type="checkbox"/> alarm output operation mode	<i>AL.Md</i>	<i>dV [[</i>	OFF: Not used DV[: Deviation high-limit alarm]DV: Deviation low-limit alarm]DV[: Deviation high/low-limit alarm [DV]Deviation high/low-limit reverse alarm PV[: Absolute value high-limit alarm]PV: Absolute value low-limit alarm LBA: Loop break alarm SBA: Sensor break alarm HBA1: Heater break alarm (CT1) HBA2: Heater break alarm (CT2) + RUN: Control output ON notice + STOP: Control output OFF notice + PAUS: Control output PAUSE notice + P.ST: Pattern control start notice + P.END: Pattern control end notice + P.OT: Pattern control delay point notice + S.ST: Step start notice + S.END: Step end notice + S.OT: Step delay point notice	-	+ [Progr m control model] 1-5 Operatio n mode: PROG	8-1 Event: EV.0 to EV.1
		<i>oFF</i>	8-1 Event: EV.2 to EV.9			

- If changing 8-2 Alarm output setting, 8-3/4 Alarm output high/low-limit value is changed as the max./min. value of the changed input type.

Alarm output operation mode

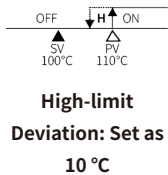
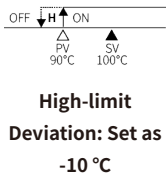
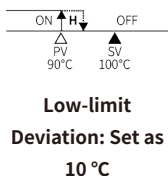
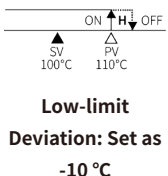
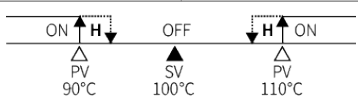
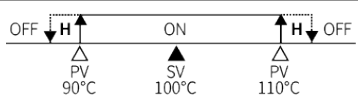
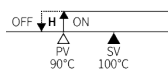
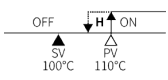
Setting	Alarm operation	Description	
OFF	-	Not used	
Deviation high-limit alarm	 <p>High-limit Deviation: Set as 10°C</p>	 <p>High-limit Deviation: Set as -10°C</p>	If the deviation of PV and SV is high-limit and higher than the deviation SV, alarm output turns ON.
Deviation low-limit alarm	 <p>Low-limit Deviation: Set as 10°C</p>	 <p>Low-limit Deviation: Set as -10°C</p>	If the deviation of PV and SV is low-limit and higher than deviation SV, alarm output turns ON.
Deviation high/low-limit alarm	 <p>High/low-limit Deviation: Set as 10°C</p>		If the deviation of PV and SV is higher than the deviation SV in high-limit or low-limit, alarm output turns ON.
Deviation high/low-limit reverse alarm	 <p>High/Low-limit Deviation: Set as 10°C</p>		If the deviation of PV and SV is high-limit or low-limit and higher than the deviation SV, the alarm output is OFF.
Absolute value high-limit alarm	 <p>Alarm absolute value: Set as 90°C</p>	 <p>Alarm absolute value: Set as 110°C</p>	If PV is higher than alarm absolute value, alarm output turns ON.

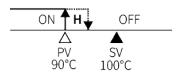
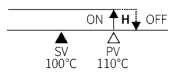
Setting	Alarm operation	Description	
Absolute value low-limit alarm	 <p>Alarm absolute value: Set as 90°C</p>	 <p>Alarm absolute value: Set as 110°C</p>	If PV is lower than alarm absolute value, alarm output turns ON.

* H: Alarm output hysteresis

Setting	Description
Loop break alarm	Loop break detection, alarm output turns ON.
Sensor break alarm	Sensor break detection, alarm output turns ON.
Heater break alarm (CT1)	At CT1, heater break detection, alarm output turns ON.
Heater break alarm (CT2)	At CT2, heater break detection, alarm output turns ON.
Control output ON notice	Control output ON, alarm output turns ON.
Control output OFF notice	Control output OFF, alarm output turns ON.
Control output PAUSE notice	Control output PAUSE, alarm output turns ON.
Pattern control start notice	Pattern control start, alarm output turns ON. It is also output in case of repeat start.
Pattern control end notice	Pattern control end, alarm output turns ON.
Pattern control delay point notice	If the total operation time of the pattern is exceeded, alarm output turns ON at the time of exceeding.
Step start notice	Step start, alarm output turns ON.
Step end notice	Step end, alarm output turns ON.
Step delay point notice	If the step operation time is exceeded, the alarm output turns ON at the time of exceeding.



If changing 8-2 Event alarm output operation mode setting, 8-3/4 Event alarm output high/low-limit value is changed as the max./min. value of the changed setting mode not to occur alarm output.

2.8.3. Alarm output high/low-limit value

Description		Display	Default	Set range	Unit	Display condition			
8-3	Event <input type="checkbox"/> alarm output low-limit value	A.L.L	1550	-F.S to F.S	°C/°F	8-2 Alarm output operation mode: DV[[to [DV]	4-1 Input type: Temp. sensor		
				Display range		8-2 Alarm output operation mode: PP[[to]PV			
				1000	-1999 to -F.S to F.S to 9999	Digit		8-2 Alarm output operation mode: DV[[to [DV]	4-1 Input type: Analog
				Display range	8-2 Alarm output operation mode: PP[[to]PV				

Description		Display	Default	Set range	Unit	Display condition		
8-4	Event <input type="checkbox"/> alarm output high-limit value	ALH	1550	-F.S to F.S	°C/°F	8-2 Alarm output operation mode: DV[[to [DV]	4-1 Input type: Temp. sensor	
				Display range		8-2 Alarm output operation mode: PP[[to]]PV		
			1000	-1999 to -F.S to F.S to 9999	Digit	8-2 Alarm output operation mode: DV[[to [DV]		4-1 Input type: Analog
				Display range		8-2 Alarm output operation mode: PP[[to]]PV		

2.8.4. Alarm output hysteresis

Set ON/OFF interval (hysteresis) of alarm output.

Description		Display	Default	Set range	Unit	Display condition	
8-5	Event <input type="checkbox"/> alarm output hysteresis	ALHY	001	001 to 100	°C/°F/ -	4-1 Input type: Temp. H, Analog	8-2 Alarm output operation mode: DV[[to]]PV, HBA <input type="checkbox"/>
				000.1 to 100.0			

2.8.5. Loop break alarm

This function measures the temperature change of the control object to diagnose the control loop and output an alarm.

During heating control (during cooling control), if control output MV is 100% (0%) and PV is not increased more than LBA detection band for LBA monitor time, alarm output turns ON.

If control output MV is 0% (100%) and PV is not decreased more than LBA detection band for LBA monitor time, alarm output turns ON.

When auto-tuning is operated, the LBA detection band and LBA monitor time are automatically set based on the auto-tuning value.



Main causes of LBA alarms

- Input sensor error (break, short circuit)
- Over external manipulators (magnets, auxiliary relays)
- Over external load (heater, cooler)
- External wiring misconnection and break

Description		Display	Default	Set range	Unit	Display condition	
8-6	Event <input type="checkbox"/> LBA monitor time	L b R t	0000	0000 (OFF) to 9999	Sec	8-2 Alarm output operation mode: LBA	
8-7	Event <input type="checkbox"/> LBA detection band	L b R b	000	000 (OFF) to 999	°C/°F	8-6 Event LBA monitor time: > 0	4-1 Input type: Temp. H
			000.0	000 (OFF) to 999	°C/°F		4-1 Input type: Temp. L
			000.0	000.0 (OFF) to 100.0	%F.S		4-1 Input type: Analog

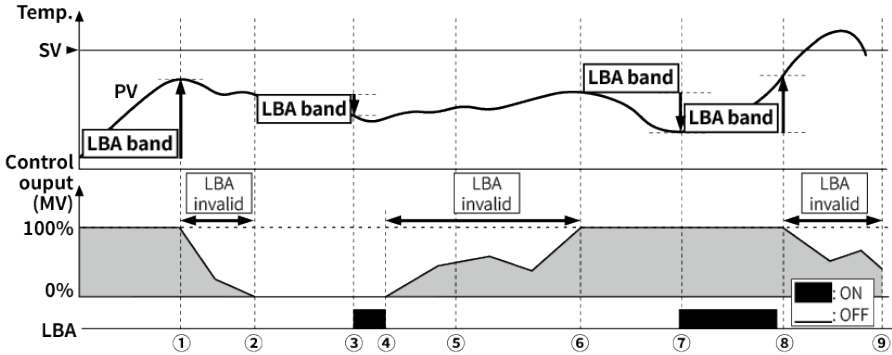

Starts control to ①	When control output MV is 100%, it increases more than LBA detection band for LBA monitor time.
① to ②	Control output MV fluctuates (LBA monitor time is reset)
② to ③	When control output MV is 0%, it decreased within LBA detection band for LBA monitor time. After LBA monitor time, loopbreak alarm (LBA) turns ON.
③ to ④	When control output MV is 0%, loopbreak alarm (LBA) maintains ON.
④ to ⑥	Control output MV fluctuates (LBA monitor time is reset)
⑥ to ⑦	When control output MV is 100%, it is not increased more than LBA detection band for LBA monitor time. After LBA monitor time, loopbreak alarm (LBA) turns ON.
⑦ to ⑧	When control output MV is 100%, it is increased over than LBA detection band for LBA monitor time. After LBA monitor time, loopbreak alarm (LBA) turns OFF.
⑧ to ⑨	Control output MV fluctuates (LBA monitor time is reset)

2.8.6. Sensor break alarm

If the sensor input is not connected or it is opened during temperature control, the alarm output is ON.

2.8.7. Heater break alarm

If the power supply is cut off due to a break in the heater, the alarm output is ON.

Heater break is detected by the temperature controller after converting the current flowing through the heater to a constant ratio (CT ratio) using a current transformer (CT).

Heater break is detected only when the control output is ON (over 250 ms).

In case of CT2 and option: 2 or more CT input model and 6-1 Control output operation: H-C, heater break is detected only when OUT2 control output is ON.

$$\text{Heater break value} = \{(\text{normal heater current value}) + (\text{break Heater current value})\} / 2$$

Description		Display	Default	Set range	Unit	Display condition	
8-3	Event <input type="checkbox"/> Heater break value	RL.L	0.0.0	[OUT1/2: Relay or SSR drive output model] 00.0 to 50.0	A	6-5/8 OUT1/2 SSR drive output method: STND	8-2 Alarm output operation mode: HBA <input type="checkbox"/>

- Heater 1 unit (capacity: 200 VAC, 1 Kw, 5 A)
 - Heater current value of normal operation: 5 A
 - Heater break Heater current value: 0 A

SV is $(5\text{ A} + 0\text{ A}) / 2 = 2.5\text{ A}$.

If the measured heater current value is lower than 2.5 A of heater break detection, it determines heater is broken and it outputs break alarm.

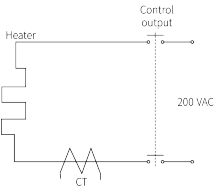

- Heater 2 units (capacity: 200 VAC, 1 Kw, 5 A)
 - Heater current value of normal operation: 10 A (5 A × 2 units)
 - If 1 heater is broken, heater current value is 5 A.

SV is $(10\text{ A} + 5\text{ A}) / 2 = 7.5\text{ A}$.

If the measured heater current value is lower than 7.5 A of heater break detection, it determines heater is broken and it outputs break alarm.

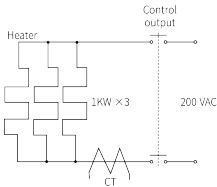

- 12-3/4 Heater current value Monitoring 1/2 is available to check the present CT value.
- It is recommended to use sold separately CT.

2.8.8. Notice pattern / step

Set the notice object of pattern or step.

Description		Display	Default	Set range	Unit	Display condition
8-8	Event <input type="checkbox"/> notice pattern/step	AL.P	ALL	PTN.0 to PTN.9, ALL	-	8-2 Alarm output operation mode: P.ST to P.OT
				ST.0 to ST.19, ALL	-	8-2 Alarm output operation mode: S.ST to S.OT

2.8.9. Event output

Set the desired terminal output of 8-1 Event.

Depending on the model and setting, the setting range is different.

Description		Display	Default	Set range	Unit	Display condition
8-9	Event <input type="checkbox"/> output	AL.O	AL.1	AL.1 to AL.6, OFF	-	8-1 Event: EV.0
			AL.2			8-1 Event: EV.1
			OFF			8-1 Event: EV.2 to EV.9



In case of OUT2: Relay output model and 6-1 control output: HEAT, COOL,
The OUT2 control output terminal is available as +1 alarm.

2.9. Alarm output parameter group: *ALM*

Description		Display	Default	Set range	Unit	Display condition
9-1	Alarm output terminal *	<i>ALM</i>	<i>AL1</i>	AL.1 to AL.7	-	-
9-2	Alarm output <input type="checkbox"/> logic *	<i>LOGC</i>	<i>OR</i>	OR, AND	-	-
9-3	Alarm output <input type="checkbox"/> option *	<i>ALLE</i>	<i>AL-AL</i>	AL-A: Standard alarm AL-B: Alarm latch	-	8-2 Alarm output operation mode: LBA, SBA, HBA <input type="checkbox"/>
				AL-A: Standard alarm AL-B: Alarm latch AL-C: Standby alarm 1 AL-D: Standby alarm latch 1 AL-E: Standby alarm 2 AL-F: Standby alarm latch 2		8-2 Alarm output operation mode: the others
9-4	Alarm output <input type="checkbox"/> contact *	<i>ALOC</i>	<i>NO</i>	NO: Normally Open, close when alarm occurs NC: Normally Closed, open when alarm occurs	-	-
9-5	Alarm output <input type="checkbox"/> ON delay time *	<i>ALON</i>	<i>0000</i>	0000 to 3600	Sec	-
9-6	Alarm output <input type="checkbox"/> OFF delay time *	<i>ALOF</i>	<i>0000</i>	0000 to 3600	Sec	-

2.9.1. Alarm output terminal and logic

Depending on the model, the setting range is different.
Set output logic and option, etc. for each alarm output terminal.

Description		Display	Default	Set range	Unit	Display condition
9-1	Alarm output terminal	AL.N	AL.1	AL.1 to AL.7	-	-
9-2	Alarm output <input type="checkbox"/> logic	LOCC	OR	OR, AND	-	-



In case of OUT2: Relay output model and 6-1 control output: HEAT, COOL,
The OUT2 control output terminal is available as +1 alarm.

2.9.2. Alarm output option

Set alarm output option of 9-1 Alarm output terminal.

Description		Display	Default	Set range	Unit	Display condition
9-3	Alarm output <input type="checkbox"/> option	AL.E	AL-R	AL-A: Standard alarm AL-B: Alarm latch	-	8-2 Alarm output operation mode: LBA, SBA, HBA <input type="checkbox"/>
				AL-A: Standard alarm AL-B: Alarm latch AL-C: Standby alarm 1 AL-D: Standby alarm latch 1 AL-E: Standby alarm 2 AL-F: Standby alarm latch 2		8-2 Alarm output operation mode: the others

Alarm output option

Setting	Description	Reapplied condition
Standard alarm	If it is an alarm condition, alarm output is ON. If it is a clear alarm condition, alarm output is OFF. In case of pattern control, alarm output turns ON - OFF at 1 second intervals. (alarm pulse)	-
Alarm latch	If it is an alarm condition, alarm output is ON and maintains ON status. (Alarm output HOLD)	-
Standby alarm 1	First alarm condition is ignored and from second alarm condition, standard alarm operates. When power is supplied and it is an alarm condition, this first alarm condition is ignored and from the second alarm condition, standard alarm operates.	Power ON
Standby alarm latch 1	If it is an alarm condition, it operates both alarm latch and standby sequence. When power is supplied and it is an alarm condition, this first alarm condition is ignored and from the second 1alarm condition, alarm latch operates.	
Standby alarm 2	First alarm condition is ignored and from second alarm condition, standard alarm operates. When re-applied standby sequence and if it is alarm condition, alarm output does not turn ON. After clearing alarm condition, standard alarm operates.	Power ON, SV changing, alarm temp./operation changing or convert stop to RUN mode.
Standby alarm latch 2	Basic operation is same as alarm latch and standby sequence1. It operates not only by power ON/OFF, but also alarm set value, or alarm option changing. When re-applied standby sequence and if it is alarm condition, alarm output does not turn ON. After clearing alarm condition, alarm latch operates.	



Alarm output clear method

- Satisfied alarm clear conditions
- Power ON/OFF
- 11-13 to 15 Digital input terminal: AL.RE is set and input the dedicated terminal
- 11-17 to 19 Shortcut function: AL.RE is set and press the dedicated keys in RUN mode

2.9.3. Alarm output contact

Description		Display	Default	Set range	Unit	Display condition
9-4	Alarm output <input type="checkbox"/> contact	AL.O.C	NO	NO: Normally Open, close when alarm occurs NC: Normally Closed, open when alarm occurs	-	-

2.9.4. Alarm output ON/OFF delay time

Set alarm output ON/OFF delay time to prevent disturbance or noise.
 During the ON/OFF delay time, the front alarm indicator flashes at a cycle of 1 second.

Description	Display	Default	Set range	Unit	Display condition
9-5 Alarm output <input type="checkbox"/> ON delay time	RLON	0000	0000 to 3600	Sec	-
9-6 Alarm output <input type="checkbox"/> OFF delay time	RLOF	0000	0000 to 3600	Sec	-

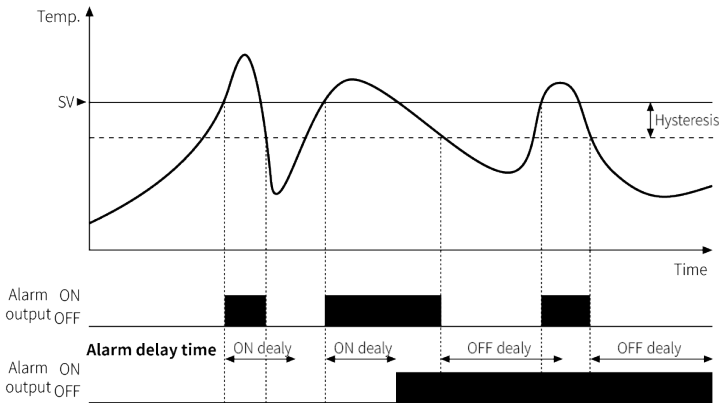

Alarm output ON delay time

After the set standby time start from the alarm output time, if the alarm output condition is satisfied, the alarm output turns ON.

Alarm output OFF delay time

After the set standby time clear from the alarm output, if the alarm output clear conditions are satisfied, the alarm output turns OFF.



- In case of 8-2 Event alarm output operation mode: notice and 9-5/6 Alarm output ON/OFF delay time: 0, 1 second delay time occurs internally.

2.10. Communication parameter group: ζ o M M

For more information about communication, refer to the TN Series Communication manual.

When connecting RS485 comm. model and during communication, the parameter setting by TN Series device may occur the malfunction.

Description		Display	Default	Set range	Unit	Display condition	
10-1	Comm. protocol	ζ o M P	R T U	RTU: Modbus RTU ASCI: Modbus ASCII SYNC: Sync Master MELC: MITSUBISHI MELSEC SYSM: OMRON SYSMAC XG: LSIS XGT/XGB	-	[RS485 comm. model]	-

Description		Display	Default	Set range	Unit	Display condition	
10-2	Comm. address	A d R 5	0 1	1 to 99	-	[RS485 comm. model]	10-1 Comm.pr otocol: RTU, ASCII
				01 to 32			10-1 Comm.pr otocol: SYNC, MELC, SYSM, XG
10-3	Comm. baudrate	b P 5	9 6	96, 192, 384, 576, 1152	(×100)bps		-
10-4	Comm. parity bit	P R E Y	N O N E	NONE, EVEN, ODD	Bit		-
10-5	Comm. stop bit	S E P	2	1, 2	Bit		-
10-6	Comm. response wait time	R S W E	2 0	5 to 99	msec		-
10-7	Comm. write	E O M W	E N A	EN.A: Comm.write enable DIS.A: Comm.write disable	-		-
10-8	Max. connected units	M A X U	1	1 to 32 Must match the number of TN Series actually connected	Unit		10-1 Comm.pr otocol: SYNC, MELC, SYSM, XG

Description		Display	Default	Set range	Unit	Display condition	
10-9	PLC address *	PLC.N	0	0 to 31	-	[RS485 comm. model]	10-1 Comm.pr otocol: MELC, SYSM, XG
10-10	CPU number *	CPUN	255	0 to 255	-		10-1 Comm.pr otocol: MELC
10-11	Register type *	PREC	0	Varied by PLC	-		10-1 Comm.pr otocol: MELC, SYSM, XG
10-12	Register start number (upper 4 bit) *	REGH	0	0 to 9999	-		10-1 Comm.pr otocol: MELC
10-13	Register start number (lower 16 bit) *	REGL	0	0 to 9999	-		10-1 Comm.pr otocol: MELC, SYSM, XG
10-14	PLC ladderless communication start time *	PSET	3000	0 to 9999	msec		10-1 Comm.pr otocol: MELC, SYSM, XG
10-15	PLC ladderless communication receive wait time *	PWET	1000	100 to 9999	msec		
10-16	PLC Monitoring 0 to 15	Rd.□□	Varied by parameter	0 to 287	-		
10-17	PLC write PA 0 to 37	WR.□□					
10-18	PLC setting copy *	PCPY	0	0: OFF 1: ON	bit		

2.10.1. Communication protocol

Description		Display	Default	Set range	Unit	Display condition
10-1	Comm. protocol	COM.P	RTU	[RS485 comm. model] RTU: Modbus RTU ASCII: Modbus ASCII SYNC: Sync Master MELC: MITSUBISHI MELSEC SYSM: OMRON SYSMAC XG: LSIS XGT/XGB	-	-

Communication protocol

Comm. protocol	Modbus RTU / ASCII	Sync Master	PLC ladderless communication
Master	Upper devices (PC, HMI, PLC, etc)	TN Series (Communication address 1)	The dedicated PLC
Slave	TN Series (up to 32 units)	TN Series (up to 32 units)	TN Series (up to 32 units)
Comm. address	01 to 99	1 to 32	1 to 32
Max. connections	-	1 to 32	1 to 32

2.10.1.1. Modbus RTU / ASCII

For more information about communication, refer to the TN Series Communication manual.

2.10.1.2. Sync Master

By connecting multiple TN Series by RS485 Communication, it is possible to simultaneously control the SV setting of Slave (up to 31 units) and control output RUN/STOP according to the control of the Master.

All of the connected TN Series devices should have the same settings below.

- 4-1 Input type
- 4-5 Analog scale decimal point

Master transmits the changed value during operation.

If SV or control output RUN/STOP is changed during transmission to each slave, it will not be applied.

Be sure to change it after transmission to all slaves is completed.

Check the status of each Slave to make sure it has been sent correctly.

If there is no response from each slave, it retries twice.

It retries from the smallest address among the failed slaves.

When an error occurs, the last address of the error is displayed on the front SV display.

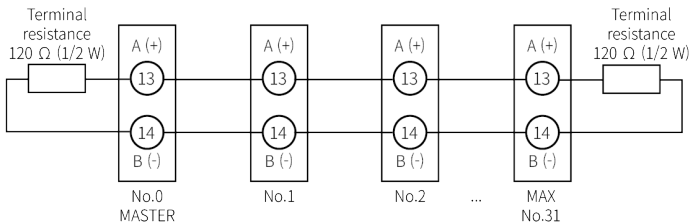

Example of connection

2.10.1.3. PLC ladderless communication

You can perform ladderless communication with PLC preset without writing ladders.

Communication with PLC is performed automatically, and monitoring or setting change of TN Series can be performed by R/W in PLC memory.

Based on PLC ladderless communication register map, it transfer Communication data per TN Series group.

PLC ladderless communication map consists of communication status group, monitoring group, parameter setting group which are listed with data address, channel name of each parameter.

For more information about communication, refer to the TN Series Communication manual.

The setting range is varied by supported PLC. For more information, refer to the PLC user manual.

PLC ladderless communication setting method

1. PLC ladderless communication group configuration
2. PLC ladderless communication environment setting
3. Initial setting
4. PLC ladderless communication

(1) MITSUBISHI MELSEC Series

Item	Description
Comm. module	QnA-compatible 3C frame (format 4), command(0401/1401) Q/FX Series(using dedicated protocol Melsec3 3C Flame 4)
Interface	RS-485, RS-422A
Synchronous	Start/Stop synchronous
Data bit configuration	Start bit: 1 Data bit: 8 parity bit: Not used stop bit: 2
Protocol	MITSUBISHI MELSEC Series PLC dedicated protocol Protocol Type: 4 (MELSEC3) Checksum: Use

(2) OMRON SYSMAC Series

Item	Description	
Comm. module	SYSMAC CS1 Series CS1W-SCB41, CS1W-SCU41	SYSMAC CJ1 series C200H-LK202-V1, C500-LK203, C120-LK202-V1
CPU Unit	SYSMAC CS1 series CPU	SYSMAC CJ1 series CPU
Interface	RS-485, RS-422A	
Synchronous	Start/Stop Synchronous	
Data bit configuration	start bit: 1 Data bit: 8 parity bit: Not used stop bit: 2	
Protocol	OMRON SYSMAC series PLC dedicated protocol Checksum: Use	

(3) LSIS XGT/XGB Series

Item	Description
Comm. module	XGL-CH2A, XGL-C42A, CNET
CPU Unit	XGK-CPUS, XBM, XBC
Interface	RS-485, RS-422A
Synchronous	Start/Stop Synchronous
Data bit configuration	start bit: 1 Data bit: 8 parity bit: Not used stop bit: 2
Protocol	LS XGT/XGB series PLC dedicated protocol Checksum: Use

2.10.2. Communication setting

Description		Display	Default	Set range	Unit	Display condition
10-2	Comm. address ⁰¹⁾	RDR5	01	[RS485 comm. model] 01 to 99	-	10-1 Comm.protocol: RTU, ASCII
				01 to 32		10-1 Comm.protocol: SYNC, MELC, SYSM, XG
10-3	Comm. baudrate	bP5	96	[RS485 comm. model] 96, 192, 384, 576, 1152	(×100)bps	-
10-4	Comm. parity bit	PRRY	NONE	[RS485 comm. model] NONE, EVEN, ODD	Bit	-
10-5	Comm. stop bit	SEP	2	[RS485 comm. model] 1, 2	Bit	-
10-6	Comm. response wait time	RSWE	20	[RS485 comm. model] 5 to 99	msec	-
10-7	Comm. write	COMW	ENR	[RS485 comm. model] EN.A: Comm.write enable DIS.A: Comm.write disable	-	-
10-8	Max. connected units	MAXU	1	[RS485 comm. model] 1 to 32 Must match the number of TN Series actually connected	Unit	10-1 Comm.protocol: SYNC, MELC, SYSM, XG

01)Max. connected units are varied by the set communication protocol.

2.10.3. PLC address

Description		Display	Default	Set range	Unit	Display condition
10-9	PLC address	<i>PLCN</i>	0	[RS485 comm. model] 0 to 31	-	10-1 Comm.protocol: MELC, SYSM, XG
10-10	CPU number	<i>CPUN</i>	255	[RS485 comm. model] 0 to 255	-	10-1 Comm.protocol: MELC

2.10.4. PLC Register

Description		Display	Default	Set range	Unit	Display condition
10-11	Register type	<i>PREG</i>	0	[RS485 comm. model] Varied by PLC	-	10-1 Comm.protocol: MELC, SYSM, XG
10-12	Register start number (upper 4 bit)	<i>REGH</i>	0	[RS485 comm. model] 0 to 9999	-	10-1 Comm.protocol: MELC
10-13	Register start number (lower 16 bit)	<i>REGL</i>	0	[RS485 comm. model] 0 to 9999	-	10-1 Comm.protocol: MELC, SYSM, XG

Register type**(1) MITSUBISHI MELSEC Series**

SV	Description
0	D register (Data register)
1	R register (File register)
2	W register (Link register)
3	ZR register (if R register is over 32767 address, the designated serial number register)

(2) OMRON SYSMAC Series

SV	Description
0	DM register (Data memory)
1 to 13	EM register (Extended data memory) Designate bank number (bank No.+10.)
14	EM register (Extended data memory) Designate current bank number

(3) LSIS XGT/XGB Series

SV	Description
0	D register (Data register)
1	R register (File register)

2.10.5. PLC ladderless communication start time

Set the time from start to applied of data writing after entering the RUN mode.

Description		Display	Default	Set range	Unit	Display condition
10-14	PLC ladderless communication start time	PSET	3000	[RS485 comm. model] 0 to 9999	msec	10-1 Comm.protocol: MELC, SYSM, XG

2.10.6. PLC ladderless communication receive wait time

Set PLC communication data receive wait time.

If normal data transmission is completed within the receive wait time, the receive wait time is ignored and moves on to the next data communication.

If the set time is too short, data communication conflict may occur.

Description		Display	Default	Set range	Unit	Display condition
10-15	PLC ladderless communication receive wait time	PWET	1000	[RS485 comm. model] 100 to 9999	msec	10-1 Comm.protocol: MELC, SYSM, XG

2.10.7. PLC Monitoring / Write parameter

Designate the parameters to monitor / write parameters in PLC.

For detailed description such as parameters assigned to each SV, refer to the TN Series communication manual.

Description		Display	Default		Set range	Unit	Display condition
10-16	PLC Monitoring 0	Rd.00	1	PV	[RS485 comm. model] 0 to 287	-	10-1 Comm. protocol: MELC, SYSM, XG
	PLC Monitoring 1	Rd.01	56	SV SV			
	PLC Monitoring 2	Rd.02	2	Heating MV			
	PLC Monitoring 3	Rd.03	3	Cooling MV			
	PLC Monitoring 4	Rd.04	4	CT1 Heatercurrent value Monitoring			
	PLC Monitoring 5	Rd.05	17	Event status display			
	PLC Monitoring 6	Rd.06	18	Alarm status display			
	PLC Monitoring 7	Rd.07	19	DI status display			
	PLC Monitoring 8 to 15	Rd.□□	0	None			

Description		Display	Default		Set range	Unit	Display condition
10-17	PLC write PA 0	WR.00	5 1	Control output RUN/STOP	[RS485 comm. model] 0 to 287	-	10-1 Comm. protocol: MELC, SYSM, XG
	PLC write PA 1	WR.0 1	5 2	Timer start / pause			
	PLC write PA 2	WR.0 2	5 3	Auto / Manual control			
	PLC write PA 3	WR.0 3	5 6	SV SV			
	PLC write PA 4	WR.0 4	6 6	Heating proportional band			
	PLC write PA 5	WR.0 5	6 7	Heating integral time			
	PLC write PA 6	WR.0 6	6 8	Heating derivative time			
	PLC write PA 7	WR.0 7	6 9	Cooling proportional band			
	PLC write PA 8	WR.0 8	7 0	Cooling integral time			
	PLC write PA 9	WR.0 9	7 1	Cooling derivative time			
	PLC write PA 10	WR. 10	8 7	Input correct			

Description		Display	Default		Set range	Unit	Display condition
10-17	PLC write PA 11	WR. 11	88	Input digital filter	[RS485 comm. model] 0 to 287	-	10-1 Comm. protocol: MELC, SYSM, XG
	PLC write PA 12	WR. 12	89	SV low-limit value			
	PLC write PA 13	WR. 13	90	SV high-limit value			
	PLC write PA 14	WR. 14	145	Sampling cycle			
	PLC write PA 15	WR. 15	161	MV low-limit value			
	PLC write PA 16	WR. 16	162	MV high-limit value			
	PLC write PA 17	WR. 17	262	Power ON, initial SV			
	PLC write PA 18	WR. 18	263	Alarm occur, control			
	PLC write PA 19	WR. 19	267	STOP, MV			
	PLC write PA 20 to 37	WR.□□	0	None			

2.10.8. PLC setting copy

Monitoring group and parameter setting group of PLC Master is available to copy to Slave.
Turn OFF the PLC power and copy.

Description		Display	Default	Set range	Unit	Display condition
10-18	PLC setting copy	PLC PY	0	[RS485 comm. model] 0: OFF 1: ON	bit	10-1 Comm.protocol: MELC, SYSM, XG



In case of copy failure, retry from the Slave with the smallest address. When an additional error occurs, the last address is displayed on the SV display.

2.11. Other parameter group: E E E

Description		Display	Default	Set range	Unit	Display condition	
11-1	Power ON, initial SV *	PR.MV	STOP	RUN: Power ON, control output run STOP: Power ON, control output stop	-	-	
11-2	Alarm occur, control *	RL.MV	CONT	CONT: With control output condition and alarm occurs, maintained operation OFF: Alarm occurs, control output stops	-	-	
11-3	Manual control, reference MV *	IL.MV	RUTO	AUTO: Controls with auto control MV of before converting Auto ↔ Manual as initial MV of manual control ⁽⁰¹⁾ PR.MV: 11-4 Manual control, controls with initial MV	-	-	
11-4	Manual control, initial MV *	PR.MV	0000	000.0: OFF, 100.0: ON	%	6-1 Control output operation : HEAT, COOL	6-2 Control method: ONOF
				000.0 to 100.0			6-2 Control method: PID
				-100.0: Cooling ON, 000.0: OFF, 100.0: Heating ON		6-1 Control output operation : H-C	6-2 Control method: ONOF
				-100.0 (Cooling) to 000.0 (OFF) to 100.0 (Heating)			6-2 Control method: PID

Description		Display	Default	Set range	Unit	Display condition	
11-5	Sensor error, MV	ERRMV	0000	000.0: OFF, 100.0: ON	%	6-1 Control output operation : HEAT, COOL	6-2 Control method: ONOF
				000.0 to 100.0			6-2 Control method: PID
				-100.0: Cooling ON, 000.0: OFF, 100.0: Heating ON		6-1 Control output operation : H-C	6-2 Control method: ONOF
				-100.0 (Cooling) to 100.0 (Heating)			6-2 Control method: PID
11-6	STOP, MV	SEMV	0000	000.0: OFF, 100.0: ON	%	6-1 Control output operation : HEAT, COOL	6-2 Control method: ONOF
				000.0 to 100.0			6-2 Control method: PID
				-100.0: Cooling ON, 000.0: OFF, 100.0: Heating ON		6-1 Control output operation : H-C	6-2 Control method: ONOF
				-100.0 (Cooling) to 100.0 (Heating)			6-2 Control method: PID
11-7	STOP, Alarm output	SEAL	CONT	CONT: Alarm output operates regardless of control output OFF: Alarm output stops when control output OFF ⁽³⁾	-	-	

Description		Display	Default	Set range	Unit	Display condition
11-8	Sensor error, high-limit alarm output *	OPAL	CONT	CONT: Alarm outputs regardless of sensor break error OFF: High-limit alarm output stops when sensor break error	-	-
11-9	Soft start time *	SS.t	0	0 (OFF) to 9999	11-10 Soft start time unit	-
11-10	Soft start time unit *	SS.Ut	SEC	SEC, MIN, HOUR	-	-
11-11	Soft start MV *	SS.MV	00	6-1 Control output operation / Varied by 6-2 Control method	%	-
11-12	Alarm latch output clear *	AL.RE	NO	NO: Not used YES: Alarm latch output clear	-	9-3 Alarm output option: AL-B, AL-D, AL-F

Description		Display	Default	Set range	Unit	Display condition
11-13	Digital input terminal 1	dl - 1	OFF	[Option: Digital input model] OFF: Not used STOP: Control output RUN/STOP PAUS: Maintain current SV reference output	-	-
11-14	Digital input terminal 2	dl - 2	OFF	AL.RE: Alarm output clear A/M: Auto/Manual control AT: Auto-tuning RUN/STOP MT.SV: Multi SV	-	-
11-15	Digital input terminal 3 to 6	dl - □	OFF	[Option: 3 or more digital input model] OFF: Not used STOP: Control output RUN/STOP PAUS: Maintain current SV reference output AL.RE: Alarm output clear A/M: Auto/Manual control AT: Auto-tuning RUN/STOP	-	-

Description	Display	Default	Set range	Unit	Display condition
11-16 U key enter parameter group`	SW-U	OFF	OFF: User RUN: Operation SV: Multi SV PID.C: PID control IN: Input PTN: Pattern CNTL: control PID.G: PID group EVNT: Event ALM: Alarm output COMM: Communication ETC: Other MON: Monitoring	Para meter group	-
11-17 U + ◀ Shortcut function`	SW-1	AL.RE	OFF: Not used PAUS: Timer/Pattern control pause	-	-
11-18 U + ▼ Shortcut function`	SW-2	OFF	AL.RE: Alarm output clear A/M: Auto/Manual control	-	-
11-19 U + ▲ Shortcut function`	SW-3	OFF	AT: Auto-tuning RUN/STOP	-	-
11-20 User level`	USER	STND	STND: Standard user HIGH: Advanced user, full parameter display	-	-
11-21 Password`	PWd	0001	Please set it twice. 0000: OFF 0001: Read only 0002 to 9999	-	-
11-22 Front key lock`	LOCK	OFF	OFF: Not used ON: Front key lock	-	-
11-23 Parameter reset`	INIT	NO	NO: Not used YES: Parameters reset (except comm. setting)	-	-

2.11.1. Power ON, initial SV

Description		Display	Default	Set range	Unit	Display condition
11-1	Power ON, initial SV	P W.MV	5 E 0 P	RUN: Power ON, control output run STOP: Power ON, control output stop	-	-

2.11.2. Alarm occur, control

It can be set up for the purpose of a redundant stabilizer with a relay alarm output.

Description		Display	Default	Set range	Unit	Display condition
11-2	Alarm occur, control	R L.MV	E 0 N E	CONT: With control output condition and alarm occurs, maintained operation OFF: Alarm occurs, control output stops	-	-

2.11.3. Manual control, reference MV

When convert from Auto to Manual control, select the the initial MV at the time of conversion.

Description		Display	Default	Set range	Unit	Display condition	
11-3	Manual control, reference MV	<i>1 E.MV</i>	<i>RU E o</i>	AUTO: Controls with auto control MV of before converting Auto ↔ Manual as initial MV of manual control ⁰¹⁾ PR.MV: 11-4 Manual control, controls with initial MV	-	-	
11-4	Manual control, initial MV	<i>PR.MV</i>	<i>0000</i>	000.0: OFF, 100.0: ON	%	6-1 Control output operation : HEAT, COOL	6-2 Control method: ONOF
				000.0 to 100.0			6-2 Control method: PID
				-100.0: Cooling ON, 000.0: OFF, 100.0: Heating ON		6-1 Control output operation : H-C	6-2 Control method: ONOF
				-100.0 (Cooling) to 000.0 (OFF) to 100.0 (Heating)			6-2 Control method: PID

01) When the power is re-applied, the control starts with the MV when the power is turned off.

2.11.4. Sensor error, MV

Set the control output MV when a sensor break error (OPEN) occurs.

Ignores the MV by the existing control output (ON/OFF and PID control) and outputs the set MV.

Description		Display	Default	Set range	Unit	Display condition	
11-5	Sensor error, MV	<i>ERR, MV</i>	0000	000.0: OFF, 100.0: ON	%	6-1 Control output operation : HEAT, COOL	6-2 Control method: ONOF
				000.0 to 100.0			6-2 Control method: PID
				-100.0: Cooling ON, 000.0: OFF, 100.0: Heating ON		6-1 Control output operation : H-C	6-2 Control method: ONOF
				-100.0 (Cooling) to 100.0 (Heating)			6-2 Control method: PID

2.11.5. STOP, MV

Set the control output MV for the control output is STOP.

Ignores the MV by the existing control output (ON/OFF and PID control) and outputs the set MV.

Description		Display	Default	Set range	Unit	Display condition	
11-6	STOP, MV	5E.MV	0000	000.0: OFF, 100.0: ON	%	6-1 Control output operation : HEAT, COOL	6-2 Control method: ONOF
				000.0 to 100.0			6-2 Control method: PID
				-100.0: Cooling ON, 000.0: OFF, 100.0: Heating ON		6-1 Control output operation : H-C	6-2 Control method: ONOF
				-100.0 (Cooling) to 100.0 (Heating)			6-2 Control method: PID

2.11.6. STOP, Alarm output

Set whether to use the alarm output when the control output is STOP.

Description		Display	Default	Set range	Unit	Display condition
11-7	STOP, Alarm output	5E.AL	CONT	CONT: Alarm output operates regardless of control output OFF: Alarm output stops when control output OFF ⁰¹⁾	-	-

01) When returning to RUN after STOP in alarm latch, standby alarm latch, the alarm output returns to the previous alarm output status.

2.11.7. Sensor error, high-limit alarm output

When occurs sensor break error (OPEN), set the wheather to use high-limit alarm output.

Description		Display	Default	Set range	Unit	Display condition
11-8	Sensor error, high-limit Alarm output	OPPL	OPEN	CONT: Alarm outputs regardless of sensor break error OFF: High-limit alarm output stops when sensor break error	-	-

2.11.8. Soft start

When the power is turned on, set the MV for a certain time to prevent sudden temperature changes.

Description		Display	Default	Set range	Unit	Display condition
11-9	Soft start time	55.5t	0	0 (OFF) to 9999	11-10 Soft start time unit	-
11-10	Soft start time unit	55.5t	5E3	SEC, MIN, HOUR	-	-
11-11	Soft start MV	55.MV	0.0	6-1 Control output operation / Varied by 6-2 Control method	%	-

Soft start MV setting range

6-1 Control output operation	6-2 Control method	Set range
HEAT, COOL	PID	0 to 1000 (0.0 to 100.0)
	ON/OFF	0/1000 (0.0/100.0)
HEAT-COOL	PID-PID	-1000 to 1000 (-100.0 to 100.0)
	PID-ON/OFF	-1000 (-100.0), 0 to 1000 (0.0 to 100.0)
	ON/OFF-PID	-1000 to 0 (-100.0 to 0.0), 1000 (100.0)
	ON/OFF-ON/OFF	-1000/0/1000 (-100.0/0.0/100.0)

- In case of manual control/STOP/input 'OPEN', 'HHHH', 'LLLL', the soft start function does operate.
- During soft start function operation, when parameters related to soft start are changed, the changed parameters are applied and operated including the progressed time.

2.11.9. Alarm latch output clear

In case of 9-3 Alarm output option: AL-B (alarm latch), AL-D (standby alarm latch 1), AL-F (standby alarm latch 2) and clear alarm output condition, maintained output, alarm output turns OFF when alarm output clear signal is ON for over min. signal width.

After clear alarm output, alarm output operates normally at the next alarm output.

Description		Display	Default	Set range	Unit	Display condition
11-12	Alarm latch output clear	RLRE	NO	NO: Not used YES: Alarm latch output clear	-	9-3 Alarm output option: AL-B, AL-D, AL-F

2.11.10. Digital input terminal

Each digital input terminal is available to set the function.
Depending on the model, digital input terminals are different.

Description		Display	Default	Set range	Unit	Display condition
11-13	Digital input terminal 1	dl - 1	OFF	[Option: Digital input model] OFF: Not used STOP: Control output RUN/STOP PAUS: Maintain current SV reference output AL.RE: Alarm output clear A/M: Auto/Manual control AT: Auto-tuning RUN/STOP MT.SV: Multi SV	-	-
11-14	Digital input terminal 2	dl - 2	OFF			
11-15	Digital input terminal 3 to 6	dl - □	OFF	[Option: 3 or more than digital input model] OFF: Not used STOP: Control output RUN/STOP PAUS: Maintain current SV reference output AL.RE: Alarm output clear A/M: Auto/Manual control AT: Auto-tuning RUN/STOP		

Multi SV setting

- Set 11-13/14 Digital input terminal 1/2: MT.SV.
If setting as one parameter, SV-0 is selected when the dedicated terminal contact signal is OFF.



Multi SV	DI-1	DI-2
SV-0	OFF	OFF
SV-1	ON	OFF
SV-2	OFF	ON
SV-3	ON	ON



- Priority: Digital input > Front shortcut key > Parameter setting
- If setting 11-13/14 Digital input terminal 1/2 are as same, it operates individually.

2.11.11. Front shortcut key

Description	Display	Default	Set range	Unit	Display condition
11-16 U key enter parameter group	SW - U	OFF	OFF: User RUN: Operation SV: Multi SV PID.C: PID control IN: Input PTN: Pattern CNTL: control PID.G: PID group EVNT: Event ALM: Alarm output COMM: Communication ETC: Other MON: Monitoring	parameter group	-
11-17 U + ◀ Shortcut function	SW - 1	RLRE	OFF: Not used PAUS: Timer/Pattern control pause	-	-
11-18 U + ▼ Shortcut function	SW - 2	OFF	AL.RE: Alarm output clear A/M: Auto/Manual control AT: Auto-tuning RUN/STOP		
11-19 U + ▲ Shortcut function	SW - 3	OFF			



- It is not able to set same as 11-13 to 15 Digital input terminal.
- Priority: Digital input > Front shortcut key > Parameter setting

2.11.12. User level

Description		Display	Default	Set range	Unit	Display condition
11-20	User level	<i>USER</i>	<i>STND</i>	STND: Standard user ⁰¹⁾ HIGH: Advanced user, full parameter display	-	-

01) The * mark parameters of the each parameter group table only display.

2.11.13. Password

This function is to restrict parameter settings.

When entering SV setting or parameter group in operation state, PASS parameter is displayed. You must enter your password to enter.

Digital input terminal, Digital input key function operates regardless of password setting.

If the password is wrong, the code that encrypted the preset password and ERR are displayed on the front SV display by blinking repeatedly at 1 second intervals.

Description		Display	Default	Set range	Unit	Display condition
11-21	Password	<i>PWd</i>	<i>0001</i>	Please set it twice. 0000: OFF 0001: Read only 0002 to 9999	-	-



If you forgot your password

If the password is entered incorrectly, the password encrypted code is displayed.

Please notice Autonics your encryption code.

Autonics can find the password saved by the user by using a code cracking program.

2.11.14. Front key lock

Description		Display	Default	Set range	Unit	Display condition
11-22	Front key lock	L o C k	o F F	OFF: Not used ON: Front key lock	-	-



The setting by communication is available.

2.11.15. Parameter reset

Description		Display	Default	Set range	Unit	Display condition
11-23	Parameter reset	I N I T	N o	NO: Not used YES: Parameters reset (except comm. setting)	-	-



In RUN mode, press ◀ + ▲ + ▼ keys for 5 secondd and the same parameter menu appears.

2.12. Monitoring parameter group: $M \square N$

Description		Display	Display range	Unit	Display condition
12-1	Heating MV Monitoring	$H - MV$	0.0 to 100.0	%	6-1 Control output operation: HEAT, H-C
12-2	Cooling MV Monitoring	$C - MV$	0.0 to 100.0	%	6-1 Control output operation: COOL, H-C
12-3	Heater current value (CT1) Monitoring	$CT1$	00.0 to 50.0	A	-
12-4	Heater current value (CT2) Monitoring	$CT2$	[Option: 2 or more CT input model] 00.0 to 50.0		6-1 Control output operation: H-C
12-5	Transmission output current value Monitoring	TR	[Current output model] 0 to 100.0	%	-
12-6	Comm. status	COM	[RS485 comm. model] Displays error address during communication	-	-
12-7	Current PID group	PID	0 to 7	PID group	6-2 Control method: PID
12-8	Current pattern	PAT	0 to 9	Pattern	[Program control model]
12-9	Current step	$STEP$	0 to 19	Step	1-6 Operation mode: PROG
12-10	Pattern elapsed time	PAT	0 to 99.59	5-1 Program time unit	
12-11	Step standby elapsed time	WRT	0.0 to 99.59		
12-12	Step remaining time	RES	00.00 to 99.59		

Description		Display	Display range	Unit	Display condition
12-13	Pattern repeat count	REPC	0 to 9999	-	[Program control model] 1-6 Operation mode: PROG 5-6 Pattern repeat count: >0
12-14	Timer remaining time	TIME	00.00 to 99.59	HH.MM	6-20 Timer mode: Except OFF
12-15	Power ON time	OPRT	Y.DDD (Power OFF, reset)	Y.DDD	-
12-16	Event <input type="checkbox"/> ON/OFF	EV - <input type="checkbox"/>	ON/OFF	-	-
12-17	Alarm output <input type="checkbox"/> ON/OFF	AL - <input type="checkbox"/>	ON/OFF	-	-
12-18	Digital input <input type="checkbox"/> ON/OFF	DI - <input type="checkbox"/>	ON/OFF	-	-