



HCL Series

Miniature compensated low pressure sensors

FEATURES

- 0 ... 5 to 0 ... 75 mbar, differential or gage
- Calibrated and temperature compensated
- Matched pressure port volumes
- Miniature SMT and SIL housings
- RoHS compliant
- Sensortech PRO services

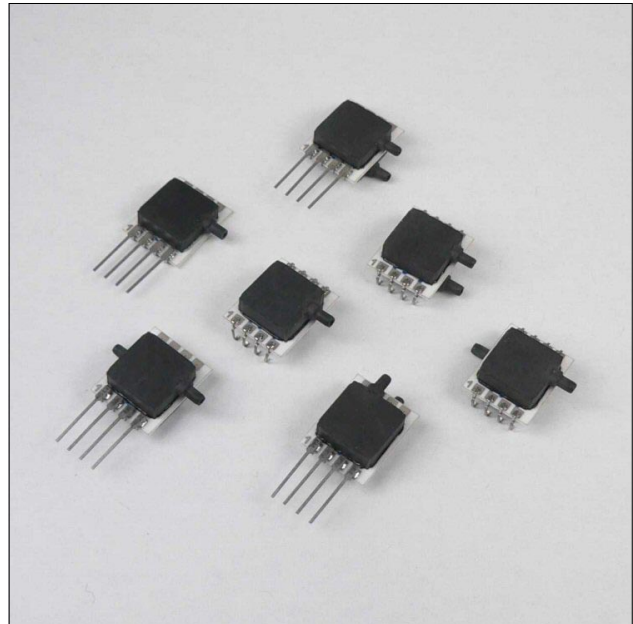

SPECIFICATIONS

Maximum ratings

Supply voltage V_s 16 V_{DC}

Lead specifications

Average preheating temperature gradient	2.5 K/s
Soak time	ca. 3 min
Time above 217°C	50 s
Time above 230°C	40 s
Time above 250°C	15 s
Peak temperature	260°C
Cooling temperature gradient	-3.5 K/s

Temperature ranges

Compensated	
HCL0005..., HCL12x5...	0 ... 50°C
all others	0 ... 70°C
Operating	-25 ... 85°C
Storage	-40 ... 125°C

Humidity limits (non-condensing) 0 ... 95 %RH

EQUIVALENT CIRCUIT

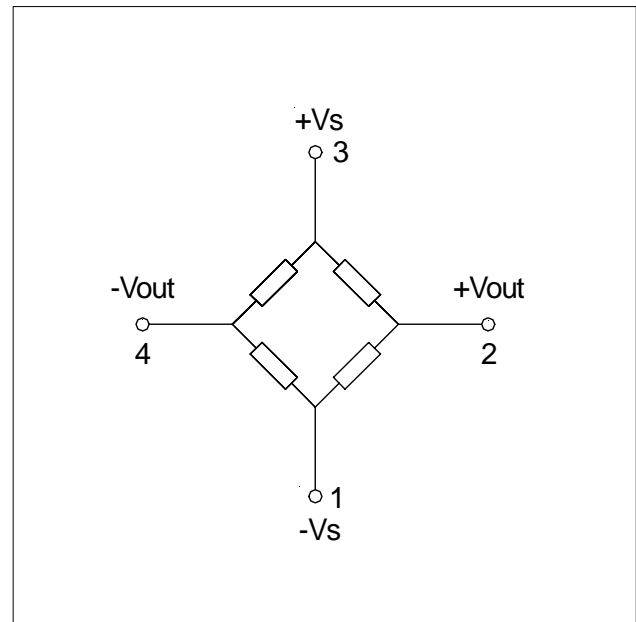



HCL Series

Miniature compensated low pressure sensors

PRESSURE SENSOR CHARACTERISTICS

Part no.	Operating pressure	Proof pressure ^{5,8}	Burst pressure ^{6,8}
HCL0005...	0...5 mbar	250 mbar	500 mbar
HCL12X5...	0...12.5 mbar	250 mbar	500 mbar
HCL0025...	0...25 mbar	500 mbar	750 mbar
HCL0050...	0...50 mbar	750 mbar	1200 mbar
HCL0075...	0...75 mbar	1200 mbar	2000 mbar

PERFORMANCE CHARACTERISTICS

($V_s = 12\text{ V}$, $T_A = 25\text{ °C}$, pressure applied to high pressure port)

HCL0005...

Characteristics	Min.	Nom.	Max.	Units
Zero pressure offset ⁴			±0.5	mV
Full scale span ^{3,4}	5.0 mbar	9.0	11.0	
	10.0 mbar	18.0	22.0	
Combined non-linearity and hysteresis ²		±0.05	±0.25	%FS
Temperature effects (0 to 50°C) ⁷	Offset		±100	µV
	Span at 5.0 mbar		±200	
Offset warm-up shift ¹			±100	
Offset position sensitivity (±1g)		±15	±50	
Offset long term drift (one year)		±80	±200	
Input resistance		4.5		kΩ
Output resistance		1.5		

Specification notes:

1. Shift is within in the first hour of excitation.
2. Non-linearity refers to the **Best Straight Line** fit, measured for offset pressure, full scale pressure and 1/2 full scale pressure.
3. Full scale span is the algebraic difference between the output voltage at full scale pressure and the output voltage at zero pressure.
4. Zero pressure offset and span are ratiometric to the supply voltage.
5. Proof pressure is the maximum pressure which may be applied without causing durable shifts of the electrical parameters of the sensing element.
6. Burst pressure is the maximum pressure which may be applied to one pressure port relative to the other port without causing leaks to the sensor.
7. Shifts are relative to 25°C.
8. The common mode pressure for the HCL series is 2 bar. Common mode pressure is the maximum pressure that can be applied to both ports of a differential pressure sensor simultaneously without damaging the sensor housing.



HCL Series

Miniature compensated low pressure sensors

PERFORMANCE CHARACTERISTICS (cont.)

($V_s = 12\text{ V}$, $T_A = 25\text{ °C}$, pressure applied to high pressure port)

HCL12X5...

Characteristics	Min.	Nom.	Max.	Units
Zero pressure offset ⁴			±0.5	mV
Full scale span ^{3,4}	19.0	20.0	21.0	
Combined non-linearity and hysteresis ²		±0.05	±0.25	%FS
Temperature effects (0 to 50°C) ⁷	Offset		±150	μV
	Span		±200	
Offset warm-up shift ¹			±50	
Offset position sensitivity (±1g)			±10	
Offset long term drift (one year)			±100	
Input resistance		4.5		kΩ
Output resistance		1.5		

HCL0025...

Characteristics	Min.	Nom.	Max.	Units
Zero pressure offset ⁴			±0.5	mV
Full scale span ^{3,4}	19.0	20.0	21.0	
Combined non-linearity and hysteresis ²		±0.05	±0.25	%FS
Temperature effects (0 to 70°C) ⁷	Offset		±150	μV
	Span		±200	
Offset warm-up shift ¹			±50	
Offset position sensitivity (±1g)			±5	
Offset long term drift (one year)			±100	
Input resistance		4.5		kΩ
Output resistance		1.5		



HCL Series

Miniature compensated low pressure sensors

PERFORMANCE CHARACTERISTICS (cont.)

($V_s = 12\text{ V}$, $T_A = 25\text{ °C}$, pressure applied to high pressure port)

HCL0050...

Characteristics	Min.	Nom.	Max.	Units
Zero pressure offset ⁴			±0.5	mV
Full scale span ^{3,4}	19.0	20.0	21.0	
Combined non-linearity and hysteresis ²		±0.05	±0.25	%FS
Temperature effects (0 to 70°C) ⁷	Offset		±150	μV
	Span		±200	
Offset warm-up shift ¹			±50	
Offset position sensitivity (±1g)			±5	
Offset long term drift (one year)			±100	
Input resistance		4.5		kΩ
Output resistance		1.5		

HCL0075...

Characteristics	Min.	Nom.	Max.	Units
Zero pressure offset ⁴			±0.5	mV
Full scale span ^{3,4}	19.0	20.0	21.0	
Combined non-linearity and hysteresis ²		±0.05	±0.25	%FS
Temperature effects (0 to 70°C) ⁷	Offset		±150	μV
	Span		±200	
Offset warm-up shift ¹			±50	
Offset position sensitivity (±1g)			±5	
Offset long term drift (one year)			±100	
Input resistance		4.5		kΩ
Output resistance		1.5		



HCL Series

Miniature compensated low pressure sensors

PHYSICAL DIMENSIONS AND ELECTRICAL CONNECTIONS

HCL...D...

SIL dual port, same side

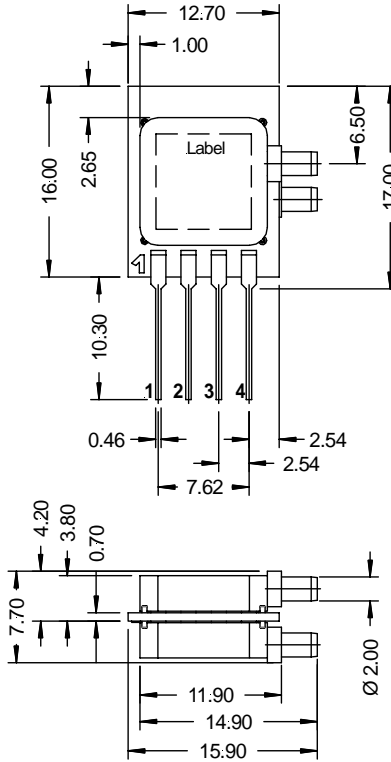
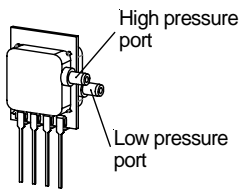
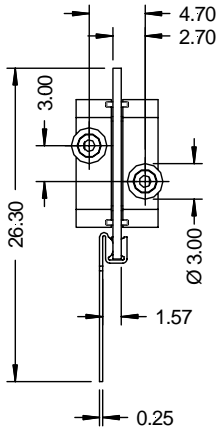

Pin	Connection
1	-Vs
2	+Vout
3	+Vs
4	-Vout

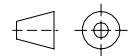

first angle projection

dimensions in mm

HCL...E...

SMD dual port, same side

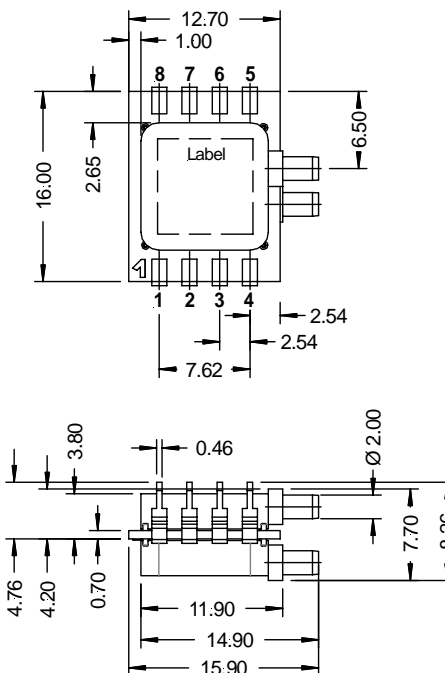
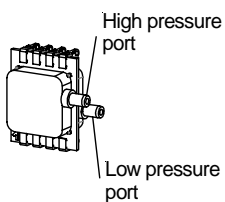
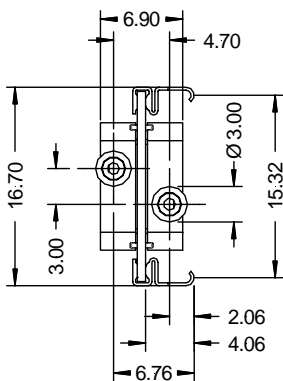

Pin	Connection
1	-Vs
2	+Vout
3	+Vs
4	-Vout
5	N / C
6	
7	
8	

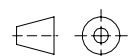

first angle projection

dimensions in mm



HCL Series

Miniature compensated low pressure sensors

PHYSICAL DIMENSIONS AND ELECTRICAL CONNECTIONS (cont.)

HCL...G...
SIL single port

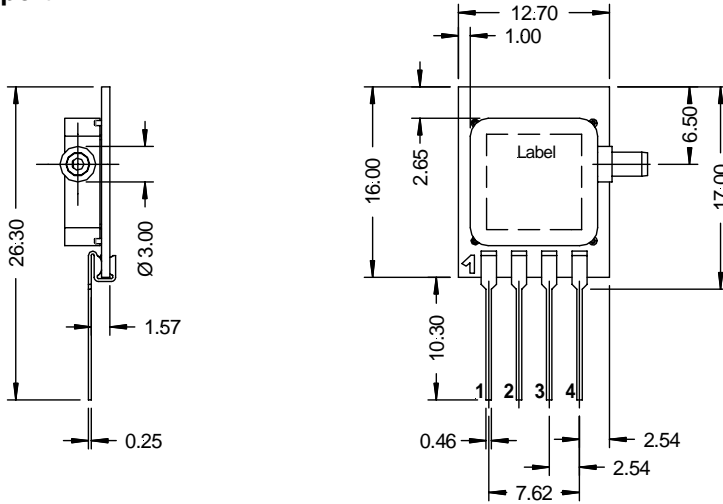

Pin	Connection
1	-Vs
2	+Vout
3	+Vs
4	-Vout

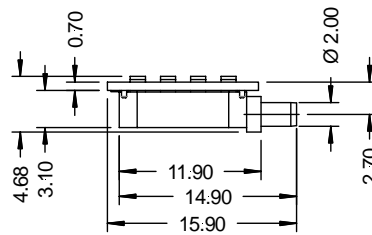
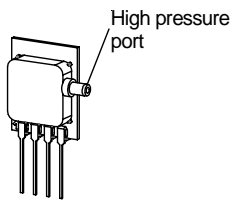

first angle projection
dimensions in mm

HCL...H...
SMD single port

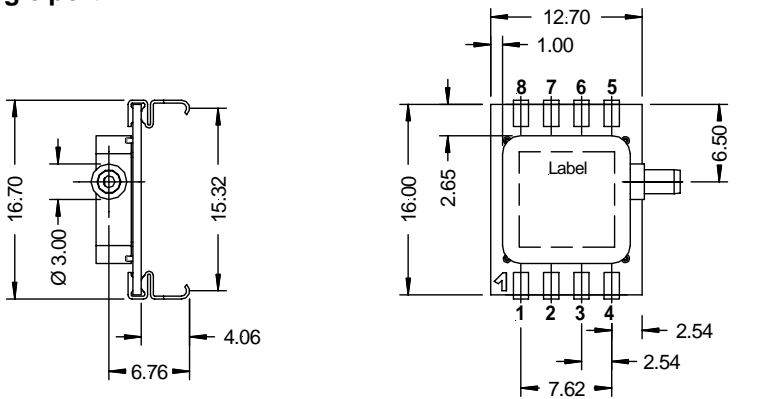

Pin	Connection
1	-Vs
2	+Vout
3	+Vs
4	-Vout
5	N / C
6	
7	
8	

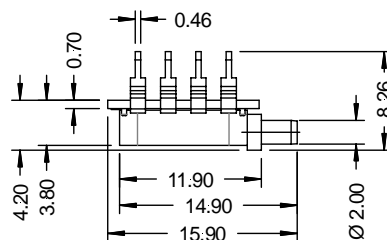
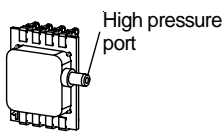

first angle projection
dimensions in mm



HCL Series

Miniature compensated low pressure sensors

HOUSING OPTIONS

Different housing options are available on request. Please contact Sensortech.ics.

SIL dual port, opposite side (HCL...P...)

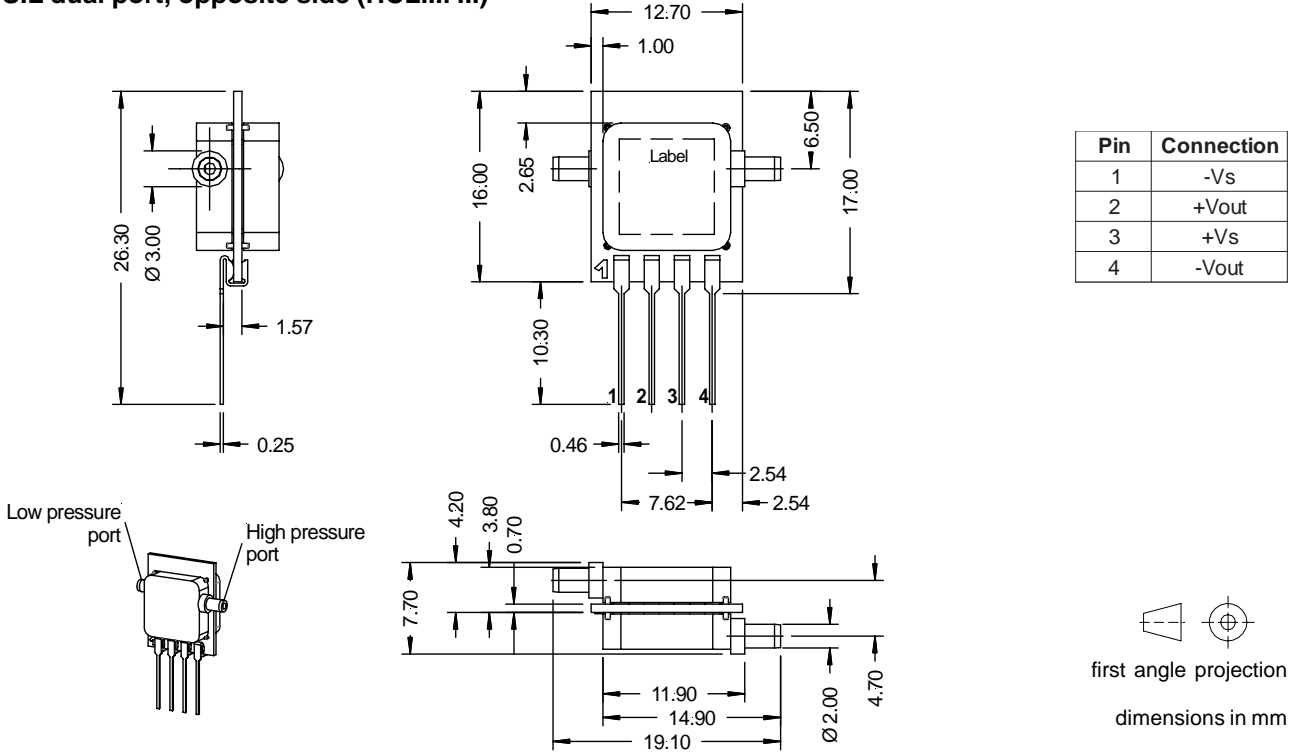

SMD dual port, opposite side (HCL...Q...)

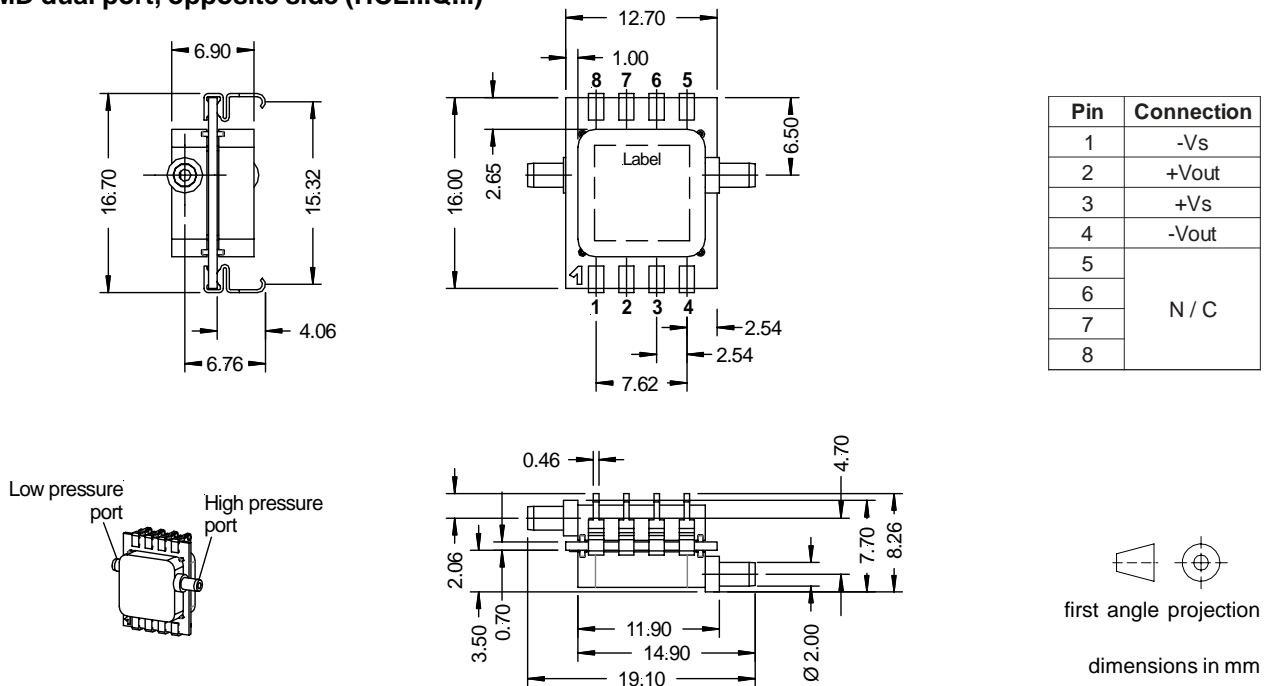



HCL Series

Miniature compensated low pressure sensors

HOUSING OPTIONS (cont.)

Different housing options are available on request. Please contact Sensortechcnics.

SIL dual port, top side (HCL...T...)

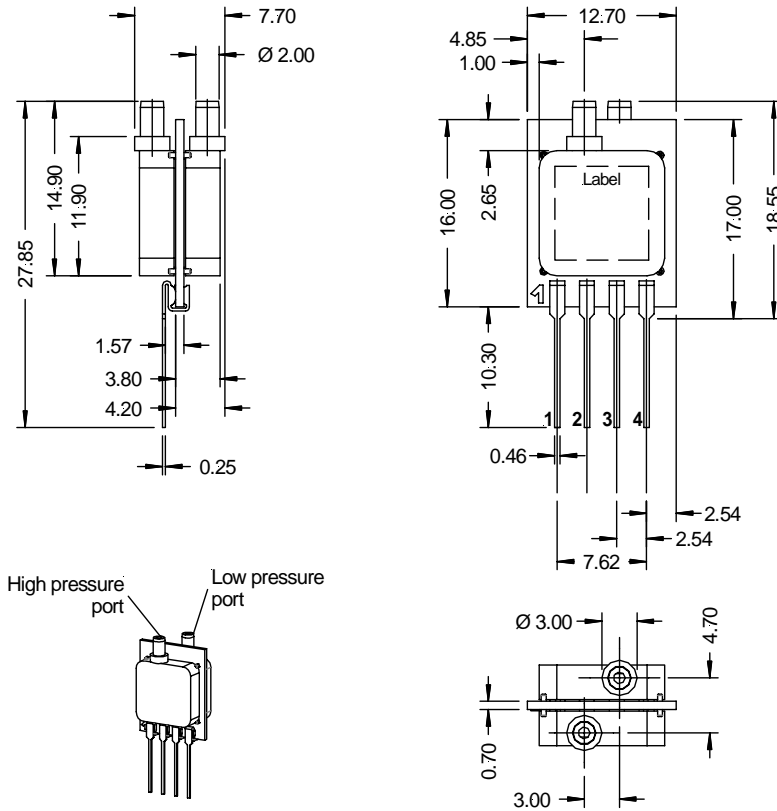

Pin	Connection
1	-Vs
2	+Vout
3	+Vs
4	-Vout

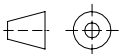

 first angle projection

 dimensions in mm



HCL Series

Miniature compensated low pressure sensors

HOUSING OPTIONS (cont.)

Different housing options are available on request. Please contact Sensortech.ics.

Barbed pressure ports

(Available for all housing styles. Sample package shown: SMD dual port, same side)

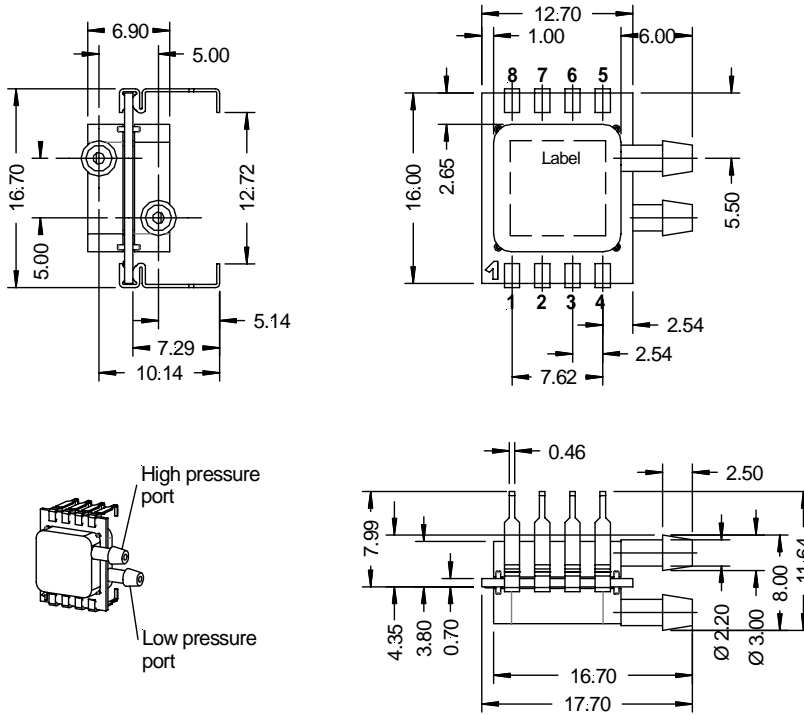

first angle projection
dimensions in mm

Dual Inline Packages (DIP)

(Available for all housing styles. Sample package shown: DIP dual port, same side)

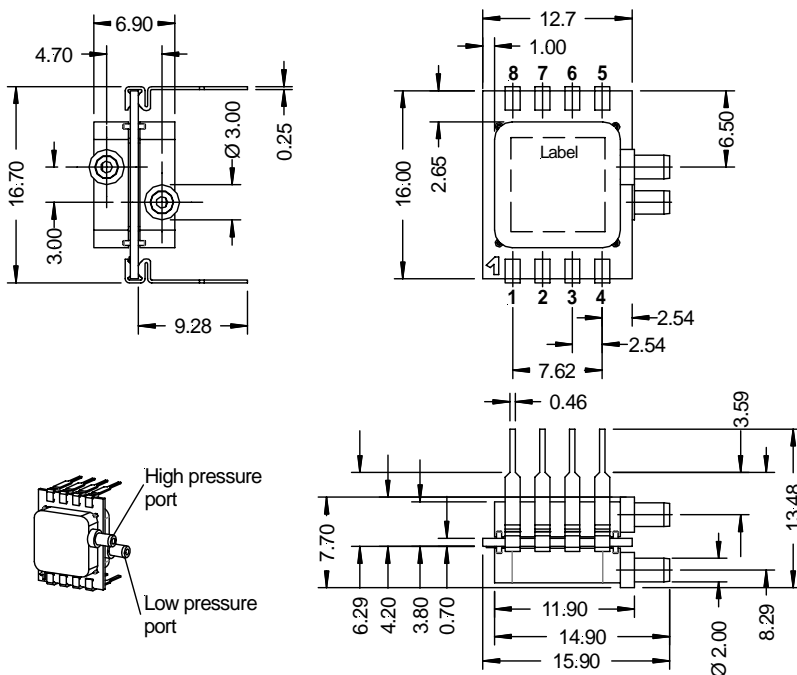

first angle projection
dimensions in mm



HCL Series

Miniature compensated low pressure sensors

ORDERING INFORMATION

Options	Series	Pressure range		Housing	
		HCL	0005	5 mbar	D
		12X5	12.5 mbar	E	Diff SMD same side
		0025	25 mbar	G	Gage SIL
		0050	50 mbar	H	Gage SMD
		0075	75 mbar	(P)	Diff SIL opposite side
				(Q)	Diff SMD opposite side
				(T)	Diff SIL same top side
				Housings P, Q, T available on request. Please contact Sensortechcnics.	
Example:	HCL	0005		D	

Custom specific pressure ranges and sensor modifications are widely available:

- barbed pressure ports
- Dual inline packages (DIP)
- ... etc.

Please contact your nearest Sensortechcnics sales office for further information.

Sensortechcnics PRO services:

- Extended warranty period of 2 years
- Custom product modifications and adaptations even for small quantities
- Advanced logistics models for supply inventory and short delivery times
- Technical support through application engineers on the phone or at your site
- Traceability of each sensor through serial numbers on request
- No product specification changes without customer notification
- No product obsolescence without very early prior notice
- Fastest possible technical response for design and QA engineers
- Long term product availability for your spares and service needs
- ... plus other services on request

Sensortechcnics reserve the right to make changes to any products herein. Sensortechcnics do not assume any liability arising out of the application or use of any product or circuit described herein, neither does it convey any license under its patent rights nor the rights of others.